

LANDANGER

1947



*«L'instrument des instruments
c'est la main.»
Aristote*

LANDANGER

Pour tout renseignement, devis et commandes :
For all information, quotes and orders:
Para más información, presupuestos y pedidos:



Tél. France : 03 25 02 10 10 - Monde - World - Mundo : +33 3 25 02 10 35

Du lundi au vendredi - Monday to Friday - De lunes a viernes
De 8 heures à 18 heures - From 8:00 am to 6:00 pm - Desde las 8 hrs hasta las 18 hrs



Fax France : 03 25 02 10 20 - Monde - World - Mundo : +33 3 25 02 10 20



contact@landanger.com



Siège - Corporate office - Sede
Landanger
217-219 Rue du Faubourg Saint-Honoré
75008 Paris
FRANCE

Service clients - Customer service - Servicio al cliente
Landanger
Rue Renée et Louis Landanger
52000 Chaumont
FRANCE

www.landanger.com

*Le plus complet des catalogues LANDANGER
depuis sa création, soit plus de 1000 pages à
votre service !*

*Instrumentalement votre,
Benoit LANDANGER*

*- Dédié à Louis LANDANGER -
Fondateur*

*The largest LANDANGER catalogue since the creation of the company, with over
1000 pages at your service!
Thank you for your confidence,*

*Benoit LANDANGER
- Dedicated to Louis LANDANGER -
The founder*

*El catálogo más completo de LANDANGER desde su creación, con más de 1000
páginas a su servicio.
Gracias por su confianza,*

*Benoit LANDANGER
- Dedicado a Louis LANDANGER -
Fundador*

L A N D A N G E R



CHIRURGIE
SURGERY
CIRUGÍA

« Vous avez le geste, nous vous apportons la précision »
« You have the gesture, we bring you the precision »
« Usted tiene el gesto, nosotros le aportamos la precisión »

Bistouris fixes - One-piece scalpels - Bisturís fijos

FARABEUF NELATON SIMS TENOTOME

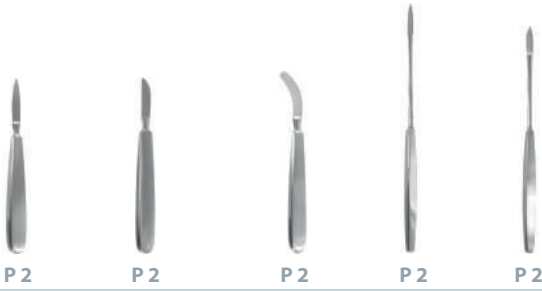

Manches de bistouris, lames U.U. - Scalpel handles, disposable blades - Mangos de bisturís, hojas desechables

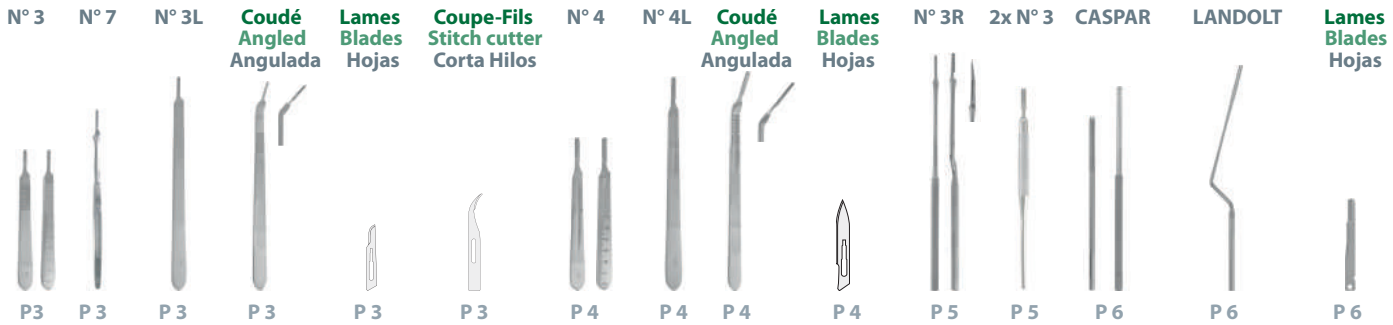

Bistouris à usage unique stériles - Disposable sterile scalpels - Bisturís desechables estériles

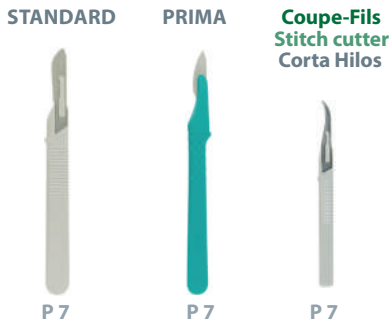

Dermatome à main - Hand dermatome - Dermátomo de mano

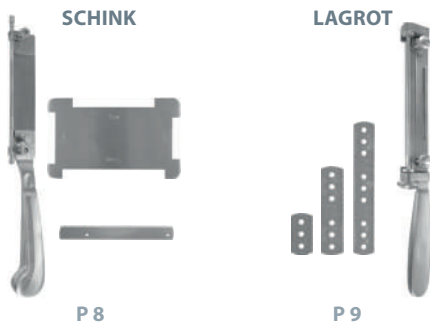

FARABEUF

NELATON

SIMS

TENOTOME

Lame 45 mm
Blade 1^{3/4}"
Hoja 45 mm

Lame 35 mm
Blade 1^{1/2}"
Hoja 35 mm

Lame 45 mm
Blade 1^{3/4}"
Hoja 45 mm

Lame 20 mm
Blade 0^{3/4}"
Hoja 20 mm

16 cm - 6^{1/4}"

B05103

20 cm - 8"

B05104



B05033
15,5 cm - 6"



B05060
15,5 cm - 6"



B05070
16 cm - 6^{1/4}"



B05090
22 cm - 8^{3/4}"



B05104
20 cm - 8"

Manches acier inoxydable
Stainless steel handles
Mangos acero inoxidable

N° 3L

N° 3L
Coudé
Angled
Angulada

N° 7

Lame carbone
Carbon blade
Hoja carbono



Stérile
Sterile
Estérile

N° 3

10

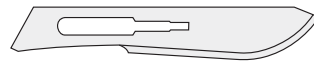

B130100

11P



B13011P

12

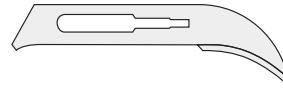

B130120

15S



B13015S

Coupe fils standard
Standard stitch cutter
Corta hilos estándar

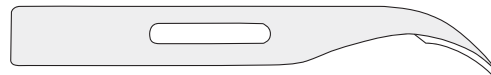

B130710

B12000
12,5 cm - 5"

B12000G
12,5 cm - 5"

B110070
16 cm - 6¹/₄"

B11013
21 cm - 8¹/₄"

B12008
20,5 cm - 8"



Manches de bistouris, lames U.U. - Scalpel handles, disposable blades - Mangos de bisturís, hojas disponibles

Manches acier inoxydable
Stainless steel handles
Mangos acero inoxidable

N° 4L

N° 4L

Coudé
Angled
Angulada

N° 4

Lame carbone
Carbon blade
Hoja carbono



Stérile
Sterile
Estérile



B12001

13,5 cm - 5¹/₄"



B12001G

13,5 cm - 5¹/₄"



B11014

21 cm - 8¹/₄"



B12009

21,5 cm - 8¹/₂"

18



B130180

19



B130190

20

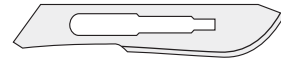

B130200

21



B130210

22



B130220

23



B130230

24



B130240

36

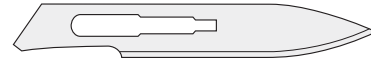

B130360

Manches acier inoxydable pour lames de bistouris 10, 11P, 12, 15S
 Stainless steel handles for 10, 11P, 12, 15S scalpel blades
 Mangos acero inoxidable para hojas de bisturís 10, 11P, 12, 15S

N° 3R



Ou
Or
O

N° 3R



Vertical
Vertical
Vertical

N° 3R



Latéral
Lateral
Lateral

2 x N° 3

1,5 mm



B123000
21 cm - 8¹/₄"

B123001
21 cm - 8¹/₄"

B123002
21 cm - 8¹/₄"

I152255
16 cm - 6¹/₄"



LANDOLT

Stérile
Sterile
Estérile



CASPAR



B160010
10 cm - 4"



B160013
13,5 cm - 5¹/₄"



B160015
15,5 cm - 6"



B160080
18 cm - 7"



B160020
20 cm - 8"



B160021
21 cm - 8¹/₄"



B160025
25 cm - 10"



N° 64

B161064



N° 65

B161065



N° 67

B161067



N° 69

B161069



4/5



1/1

Bistouris standard
Standard scalpels
Bisturís estándar



N° 21

Bistouris PRIMA
PRIMA scalpels
Bisturís PRIMA



N° 23

B132100

B13211P

B132120

B13215S

B132180

B132190

B132200

 B132210

B132220

B132230

B132240

B134100

B13411P

B134120

B13415S

B134180

B134190

B134200

B134210

B134220

 B134230

B134240

10

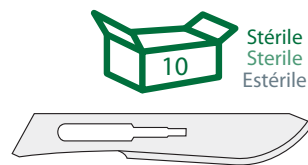

11P



12

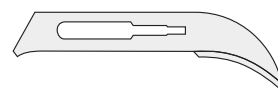

15S



18



19



20



21



22



23



24



Stérile
Sterile
Estérile



Bistouri coupe fils
Stitch cutter scalpel
Bisturís corta hilos



B132700

SCHINK

Livré avec 2 plaques, 1 lame
Supplied with 2 plates, 1 blade
Entregado con 2 placas, 1 hoja

Réglable, 0,1 - 2 mm
Adjustable, 0,1 - 2 mm
Ajustable, 0,1 - 2 mm

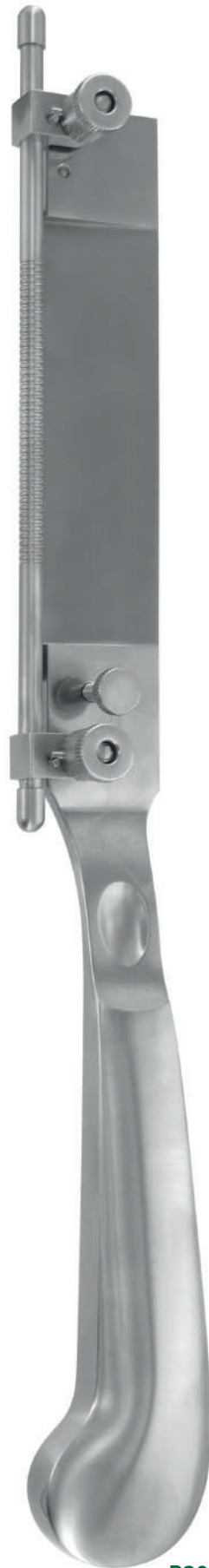

B20010
30 cm - 11³/₄"

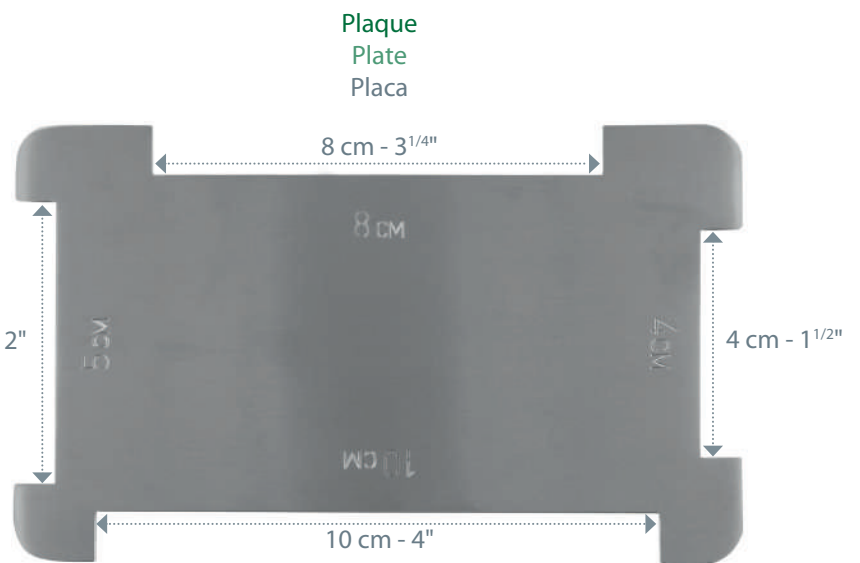

Plaque
Plate
Placa

B20030

Lame de rechange
Spare blade
Hoja de cambio



B20040

10 cm - 4"



LAGROT

Livré avec une boîte de 6 lames
 Supplied with 1 box of 6 blades
 Entregado con 1 caja de 6 hojas

Réglable, 0,1 - 3 mm
 Adjustable, 0,1 - 3 mm
 Ajustable, 0,1 - 3 mm

- 40 mm - 1^{1/2}" **B20045**
- 90 mm - 3^{1/2}" **B20050**
- 140 mm - 5^{1/2}" **B20060** 

Lames / Blades / Hojas

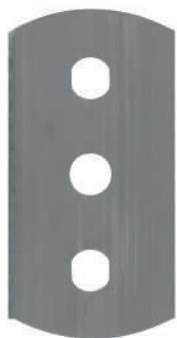

B20015
40 mm - 1^{1/2}"



B20020
90 mm - 3^{1/2}"



B20025
140 mm - 5^{1/2}"



4/5



B20060
30 cm - 11^{3/4}"

140 mm - 5^{1/2}"

Pinces à dissection - Dissecting forceps - Pinzas para disección

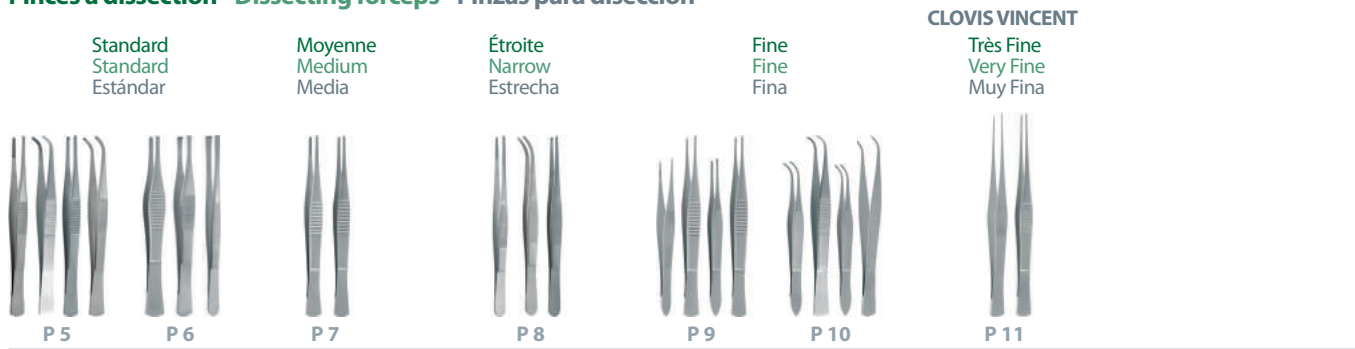

Pinces à dissection spéciales - Special dissecting forceps - Pinzas para disección especiales

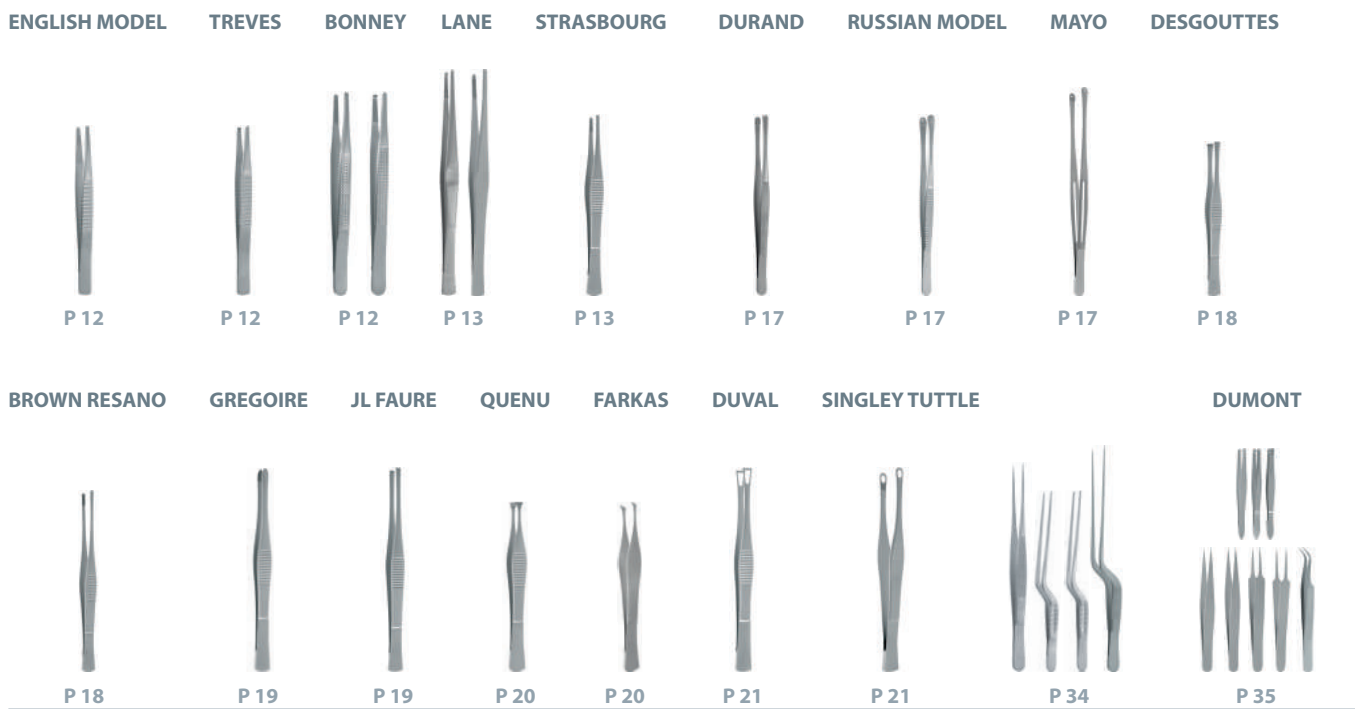

Pinces à dissection délicates - Delicate dissecting forceps - Pinzas para disección delicadas

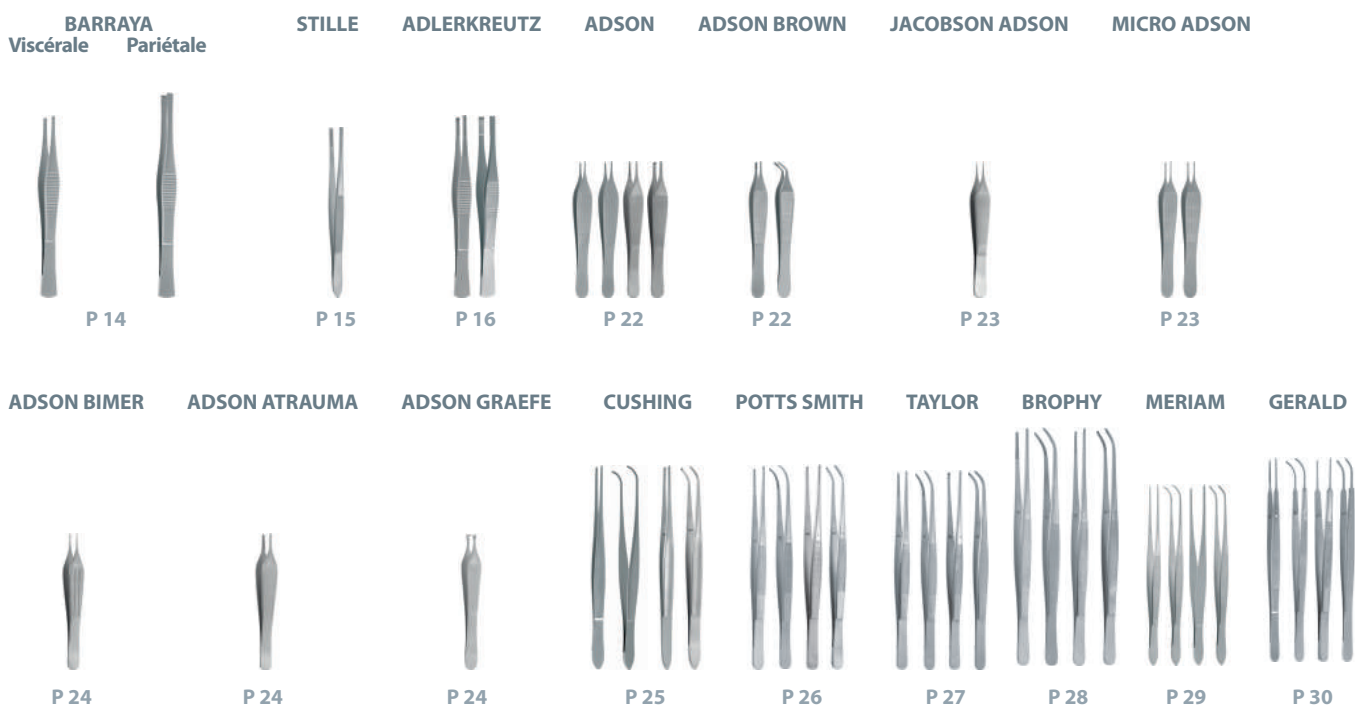

Pincès à dissection délicates - Delicate dissecting forceps - Pinzas para disección delicadas

MC INDOE GILLIES GILLIES WAUGH WAUGH SEMKEN DUFOURMENTEL VISE OSCHNER AUSTIN PERRY



PRECELLE



Pincès à dissection ophtalmologiques - Ophthalmologic dissecting forceps - Pinzas para disección oftalmológicas



Pincès à dissection ORL - ENT dissecting forceps - Pinzas para disección ORL

TROELTSCH POLITZER LUCAE JANSEN LUCAE



Pincès à dissection vasculaires - Vascular dissecting forceps - Pinzas para disección vasculares

DEBAKEY COOLEY DEBAKEY GERALD DEBAKEY DIETRICH DEBAKEY

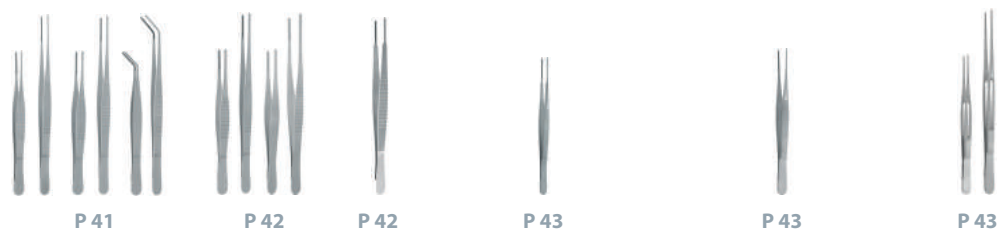

Pinces à dissection mors tungstène - Dissecting forceps with tungsten jaws - Pinzas para disección boca de tungsteno

DEBAKEY Standard Standard Estándar OEHLER WANGENSTEEN EVANS POTTS-SMITH CUSHING GRUENWALD ADSON MICRO-ADSON

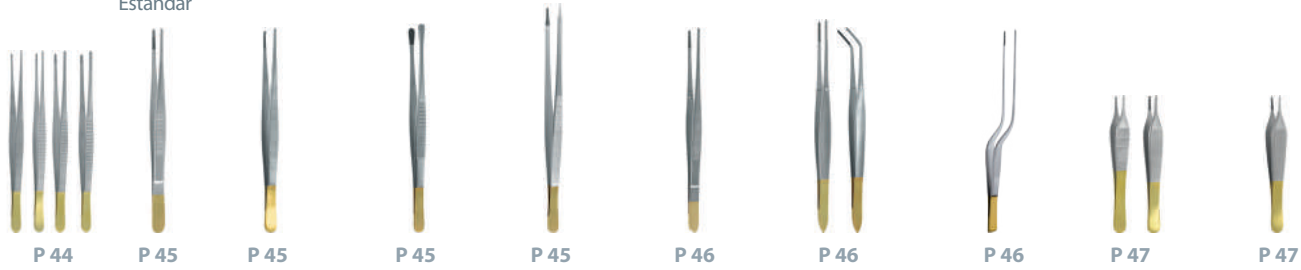

SEMKEN MC INDOE



Pinces à dissection Prestige - Prestige dissecting forceps - Pinzas para disección Prestige

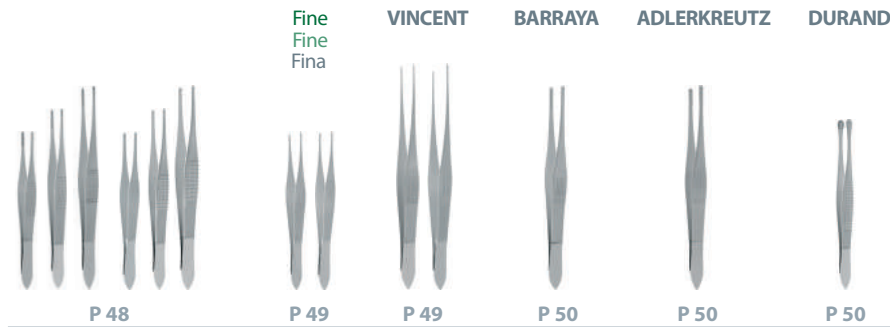

Pinces à échardes - Splinters forceps - Pinzas para astillas

FELCHENFELD HUNTER WALTER-CARMALT PEET STIEGLITZ



Microchirurgie pinces fines - Microsurgery fine forceps - Microcirugía pinzas finas

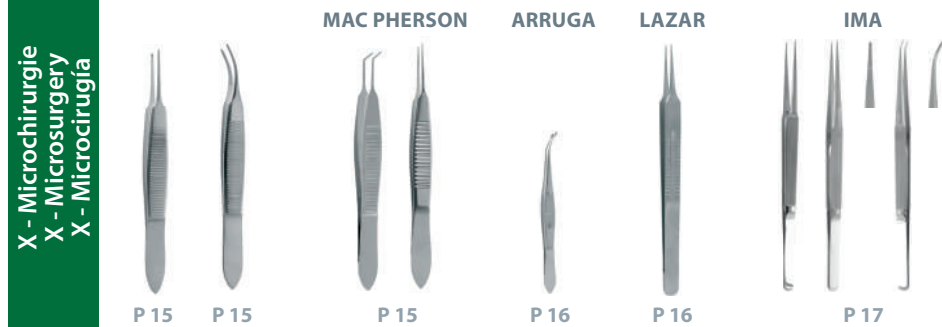

X - Microchirurgie
X - Microsurgery
X - Microcirugía

II - Dissection
II - Dissecting
II - Disección

Instrumentation de service - Instrumentation for services - Instrumentación de servicio



XV - Divers
XV - Miscellaneous
XV - Diversos

ADSON



P 17

Pinces à dissection standards - Standard dissecting forceps - Pinzas para disección estándares

Sans griffes Without teeth Sin dientes		STANDARD - STANDARD - ESTÁNDAR	1 x 2 griffes 1 x 2 teeth 1 x 2 dientes	
B40005	-	10 cm - 4"	B40045	-
B40010	B401140	12 cm - 4 ³ / ₄ "	B40050	B401150
B40015	B401141	14 cm - 5 ¹ / ₂ "	B40055	B401151
 B40020	B401142	16 cm - 6 ¹ / ₄ "	B40060	B401152 
B40025	B401143	18 cm - 7"	B40065	B401153
B40030	B401144	20 cm - 8"	B40070	B401154
B40035	B401145	25 cm - 10"	B40075	B401155
B40040	-	30 cm - 11 ³ / ₄ "	B40080	-



B40020
16 cm - 6¹/₄"



B401142
16 cm - 6¹/₄"



B40060
16 cm - 6¹/₄"

B401152
16 cm - 6¹/₄"

STANDARD - STANDARD - ESTÁNDAR

 B40090	14 cm - 5 1/2"	B400901	14 cm - 5 1/2"	B400902
B40095	16 cm - 6 1/4"	B400951	16 cm - 6 1/4"	B400952 
B40100	18 cm - 7"	-	18 cm - 7"	-
B40105	20 cm - 8"	-	20 cm - 8"	-
B40092	25 cm - 10"	-	25 cm - 10"	-

2 x 3 griffes
2 x 3 teeth
2 x 3 dientes



B40095
16 cm - 6 1/4"

3 x 4 griffes
3 x 4 teeth
3 x 4 dientes





B400951
16 cm - 6 1/4"

4 x 5 griffes
4 x 5 teeth
4 x 5 dientes



B400952
16 cm - 6 1/4"

Pinces à dissection moyennes - Medium dissecting forceps - Pinzas para disección medias finas

	Sans griffes Without teeth Sin dientes	MOYENNE - MEDIUM - MEDIA - 2,5 mm	1 x 2 griffes 1 x 2 teeth 1 x 2 dientes
	B40021	16 cm - 6 ¹ / ₄ "	B40061 
	B40026	18 cm - 7"	B40066
	B40031	20 cm - 8"	B40071





B40021
16 cm - 6¹/₄"



B40061
16 cm - 6¹/₄"

Pinces à dissection étroites - Narrow dissecting forceps - Pinzas para disección estrecha

Sans griffes Without teeth Sin dientes		ETROITE - NARROW - ESTRECHA	1 x 2 griffes 1 x 2 teeth 1 x 2 dientes
B401110	B401120	11,5 cm - 4 ¹ / ₂ "	B401130
B401111	B401121	14,5 cm - 5 ³ / ₄ "	B401131
 B401112	B401122	16 cm - 6 ¹ / ₄ "	B401132 
B401113	B401123	18 cm - 7"	B401133
B401114	B401124	20 cm - 8"	B401134
B401115	B401125	25 cm - 10"	B401135



B401112
16 cm - 6¹/₄"





B401122
16 cm - 6¹/₄"



B401132
16 cm - 6¹/₄"

Pinces droites à dissection fines - Fine straight dissecting forceps - Pinzas para disección finas rectas

Sans griffes Without teeth Sin dientes	FINE - FINE - FINA	1 x 2 griffes 1 x 2 teeth 1 x 2 dientes
B40120	10 cm - 4"	B40145
B40125	12 cm - 4 ³ / ₄ "	B40150
 B40130	14 cm - 5 ¹ / ₂ "	B40155 
 B40135	16 cm - 6 ¹ / ₄ "	B40160 
B40140	18 cm - 7"	B40165
B401430	20 cm - 8"	B401680
B401432	25 cm - 10"	B401682
B401434	30 cm - 11 ³ / ₄ "	B401684







B40130 14 cm - 5¹/₂"
B40135 16 cm - 6¹/₄"



B40155 14 cm - 5¹/₂"
B40160 16 cm - 6¹/₄"

Pinces courbes à dissection fines - Fine curved dissecting forceps - Pinzas para disección finas curvas

Sans griffes Without teeth Sin dientes	FINE - FINE - FINA COURBE - CURVED - CURVA	1 x 2 griffes 1 x 2 teeth 1 x 2 dientes
B401220	10 cm - 4"	B401470
B401270	12 cm - 4 ³ / ₄ "	B401520
 B40132	14 cm - 5 ¹ / ₂ "	B40157 
 B401370	16 cm - 6 ¹ / ₄ "	B401620 
B401420	18 cm - 7"	B401670
B401431	20 cm - 8"	B401681
B401433	25 cm - 10"	B401683
B401435	30 cm - 11 ³ / ₄ "	B401685



B40132
14 cm - 5 ¹/₂"



B401370
16 cm - 6 ¹/₄"

B40157
14 cm - 5 ¹/₂"

B401620
16 cm - 6 ¹/₄"

CLOVIS VINCENT

TRÈS FINE - VERY FINE - MUY FINA

B401698	15 cm - 6"	B401748
B401699	18 cm - 7"	B401749
 B40170	20 cm - 8"	B40175 
B401710	25 cm - 10"	B401760
B401711	30 cm - 11 ^{3/4} "	B401761

Sans griffes
Without teeth
Sin dientes



B40170
20 cm - 8"

1 x 2 griffes
1 x 2 teeth
1 x 2 dientes



B40175
20 cm - 8"

ENGLISH MODEL

TREVES

BONNEY

B401820

13 cm - 5"

B401830

Sans griffes
Without teeth
Sin dientes

1 x 2 griffes
1 x 2 teeth
1 x 2 dientes



B401821

15 cm - 6"

B401831



Sans griffes
Without teeth
Sin dientes

1 x 2 griffes
1 x 2 teeth
1 x 2 dientes



B401821
15 cm - 6"



B401831
15 cm - 6"





B401840
18 cm - 7"



B401841
18 cm - 7"

LANE

STRASBOURG

	B401800	15 cm - 6"	B401810	
	B401801	20 cm - 8"	B401811	

14 cm - 5 1/2"	B40200	
16 cm - 6 1/4"	B40205	
18 cm - 7"	B40210	
20 cm - 8"	B40215	
25 cm - 10"	B402151	
30 cm - 11 3/4"	B402152	

1 x 2 griffes
1 x 2 teeth
1 x 2 dientes

2 x 3 griffes
2 x 3 teeth
2 x 3 dientes

Mors quadrillés
Squared jaws
Bocas cuadriculadas

1 x 2 griffes
À talon
1 x 2 teeth
With heel
1 x 2 dientes
Con talón



B401801
20 cm - 8"



B401811
20 cm - 8"



B40205
16 cm - 6 1/4"

BARRAYA (VISCÉRALE)

14 cm - 5 1/2"	B40225	
16 cm - 6 1/4"	B40230	
18 cm - 7"	B40235	
20 cm - 8"	B40240	
25 cm - 10"	B40245	
30 cm - 11 3/4"	B402451	

BARRAYA (PARIETALE)

16 cm - 6 1/4"	B402455	
18 cm - 7"	B40246	
20 cm - 8"	B40248	
25 cm - 10"	B40249	
30 cm - 11 3/4"	B402491	



2 x 3 griffes
Mors étroits quadrillés
2 x 3 teeth
Narrow jaws squared
2 x 3 dientes
Bocas estrechas cuadriculadas

B40230
16 cm - 6 1/4"



4 x 5 griffes
Mors larges quadrillés
4 x 5 teeth
Wide jaws squared
4 x 5 dientes
Bocas anchas cuadriculadas

B40246
18 cm - 7"



STILLE

13 cm - 5"	B402200	
15 cm - 6"	B402201	
17 cm - 6 ³ / ₄ "	B402202	
20 cm - 8"	B402203	



Mors striés
Serrated jaws
Bocas estriadas

B402201
15 cm - 6"

	ADLERKREUTZ	
3 x 4 griffes 3 x 4 teeth 3 x 4 dientes		5 x 6 griffes 5 x 6 teeth 5 x 6 dientes
B40374	14 cm - 5 1/2"	-
 B40375	16 cm - 6 1/4"	B403959 
B40380	18 cm - 7"	B403960
B40385	20 cm - 8"	B403961
B40390	25 cm - 10"	B403962
B403950	30 cm - 11 3/4"	B403963



B40375
16 cm - 6 1/4"

À talon
With heel
Con talón



B403959
16 cm - 6 1/4"

DURAND (PATTE DE VELOURS)

RUSSIAN MODEL

MAYO

 B40250	15 cm - 6"	B402655	
B40255	20 cm - 8"	B402656	
B40260	25 cm - 10"	B402657	
B40265	30 cm - 11 ^{3/4} "	-	



B40255
20 cm - 8"



B402656
20 cm - 8"



B402660
23 cm - 9"

DESGOUTTES

18 cm - 7"	B40280 
20 cm - 8"	B40285
22 cm - 8 5/8"	B40290
25 cm - 10"	B40295
30 cm - 11 3/4"	B40300

BROWN RESANO

16 cm - 6 1/4"	B403040
20 cm - 8"	B40305 
25 cm - 10"	B40310
30 cm - 11 3/4"	B40315

4 x 5 griffes
4 x 5 teeth
4 x 5 dientes



B40280
18 cm - 7"



B40305
20 cm - 8"

GREGOIRE

18 cm - 7"

B40270



20 cm - 8"

B40275

J.L. FAURE

18 cm - 7"

B40415



20 cm - 8"

B40420

25 cm - 10"

B40425

30 cm - 11^{3/4}"

B404251





B40270
18 cm - 7"

3 x 4 griffes
3 x 4 teeth
3 x 4 dientes



B40415
18 cm - 7"

QUENU

	B40325	12 cm - 4 3/4"	-
	B40330	15 cm - 6"	B403305
	B40335	18 cm - 7"	-
	B40340	20 cm - 8"	B403405 
	B40345	25 cm - 10"	-
	B40350	30 cm - 11 3/4"	-

FARKAS

12 cm - 4 3/4"	B404349
15 cm - 6"	B40435 
18 cm - 7"	B404360

MODELE LEPINE
LEPINE MODEL
MODELO LEPINE



B40330
15 cm - 6"



B403405
20 cm - 8"



B40435
15 cm - 6"



DUVAL

15 cm - 6"	B40355
18 cm - 7"	B40360 
20 cm - 8"	B40365
25 cm - 10"	B403655
30 cm - 11 ^{3/4} "	B403660



B40360
18 cm - 7"

SINGLEY TUTTLE

18 cm - 7"	B403670 
23 cm - 9"	B403680
30 cm - 11 ^{3/4} "	B403690

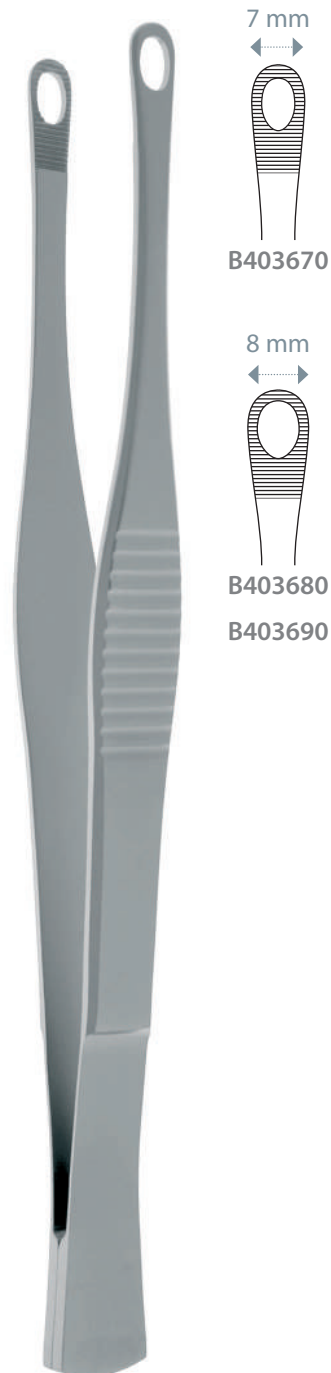

B403670
18 cm - 7"

ADSON

ADSON BROWN

12 cm - 4^{3/4}"

B40440

B40445



B404430

B404440



B40448

B404490

15 cm - 6"

B404450

B404451

-

B404441

18 cm - 7"

B404453

B404454

Sans griffes
Without teeth
Sin dientes

1 x 2 griffes
1 x 2 teeth
1 x 2 dientes

1 x 2 griffes
1 x 2 teeth
1 x 2 dientes

2 x 3 griffes
2 x 3 teeth
2 x 3 dientes

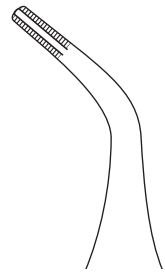
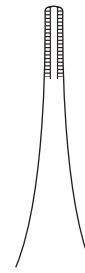
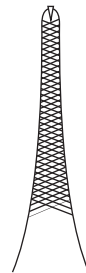
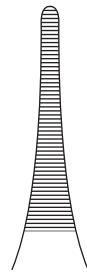

B40440

12 cm - 4^{3/4}"

B40445

12 cm - 4^{3/4}"

B404430

12 cm - 4^{3/4}"

B404440

12 cm - 4^{3/4}"

B40448

12 cm - 4^{3/4}"

B404490

12 cm - 4^{3/4}"

JACOBSON ADSON

12 cm - 4^{3/4}" **B404458** 
 15 cm - 6" **B404459**

Sans griffes
 Without teeth
 Sin dientes

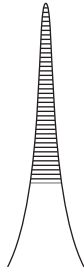

B404458
 12 cm - 4^{3/4}"

MICRO ADSON

12 cm - 4^{3/4}" **B40447** **B40446** 
 15 cm - 6" **B404470** **B404471**

Sans griffes
 Without teeth
 Sin dientes

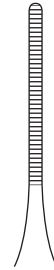

B40447
 12 cm - 4^{3/4}"

1 x 2 griffes
 1 x 2 teeth
 1 x 2 dientes



B40446
 12 cm - 4^{3/4}"

ADSON BIMER

ADSON ATRAUMA

ADSON GRAEFE

 B404475	12 cm - 4 3/4"	 B404495	12 cm - 4 3/4"	B404456 
-	15 cm - 6"	B404496	15 cm - 6"	B404457

1 x 2 griffes
1 x 2 teeth
1 x 2 dientes



Sans griffes
Without teeth
Sin dientes

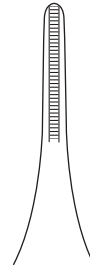

B404475
12 cm - 4 3/4"



B404495
12 cm - 4 3/4"



B404456
12 cm - 4 3/4"

CUSHING

Sans griffes
Without teeth
Sin dientes

1 x 2 griffes
1 x 2 teeth
1 x 2 dientes

18 cm - 7" 

B40400

B404021

18 cm - 7"

B404020

B404022

20 cm - 8"

B404005



B40400
18 cm - 7"



B404021
18 cm - 7"



B404020
18 cm - 7"





B404022
18 cm - 7"

Sans griffes
Without teeth
Sin dientes

POTTS SMITH

1 x 2 griffes
1 x 2 teeth
1 x 2 dientes

	B407810	B407811	18 cm - 7"	B407840	B407841	
	B407820	B407821	21 cm - 8 1/4"	B407850	B407851	
	B407830	B407831	25 cm - 10"	B407860	B407861	



B407810
18 cm - 7"

B407811
18 cm - 7"



B407840
18 cm - 7"

B407841
18 cm - 7"

TAYLOR

Sans griffes
Without teeth
Sin dientes



B404090
17,5 cm - 7"

B404091
17,5 cm - 7"

1 x 2 griffes
1 x 2 teeth
1 x 2 dientes



B404100
17,5 cm - 7"

B404101
17,5 cm - 7"

Sans griffes
Without teeth
Sin dientes

BROPHY

1 x 2 griffes
1 x 2 teeth
1 x 2 dientes



B404110
21 cm - 8¹/₄"

B404111
21 cm - 8¹/₄"



B404120
21 cm - 8¹/₄"

B404121
21 cm - 8¹/₄"

MERIAM

Sans griffes
Without teeth
Sin dientes



B403954
16 cm - 6¹/₄"



B403952
16 cm - 6¹/₄"

1 x 2 griffes
1 x 2 teeth
1 x 2 dientes



B403955
16 cm - 6¹/₄"



B403953
16 cm - 6¹/₄"

GERALD

II - Dissection
II - Dissecting
II - Disección

Sans griffes
Without teeth
Sin dientes

1 x 2 griffes
1 x 2 teeth
1 x 2 dientes



B40406
18 cm - 7"



B404061
18 cm - 7"







B40404
18 cm - 7"



B404041
18 cm - 7"

Pinces à dissection délicates - Delicate dissecting forceps - Pinzas para disección delicadas

	MC INDOE	GILLIES	GILLIES (WAUGH)	WAUGH	
15 cm - 6"	B404010 	B408601 	B408602 	B408610	B408620 
20 cm - 8"	-	-	B408603	B408611	B408621

Sans griffes
Without teeth
Sin dientes

1 x 2 griffes
1 x 2 teeth
1 x 2 dientes

1 x 2 griffes
1 x 2 teeth
1 x 2 dientes

Sans griffes
Without teeth
Sin dientes

1 x 2 griffes
1 x 2 teeth
1 x 2 dientes



B404010
15 cm - 6"



B408601
15 cm - 6"



B408602
15 cm - 6"



B408610
15 cm - 6"



B408620
15 cm - 6"

SEMKEN

DUFOURMENTEL

12 cm - 4^{3/4}"

B408500

B408502

B408501

B408515



12 cm - 4^{3/4}"

B408522

15 cm - 6"



B408510

B408512

B408511

B408516

16 cm - 6^{1/4}"

B408526



Sans griffes
Without teeth
Sin dientes

Sans griffes
Without teeth
Sin dientes

1 x 2 griffes
1 x 2 teeth
1 x 2 dientes

2 x 3 griffes
2 x 3 teeth
2 x 3 dientes

3 x 4 griffes
3 x 4 teeth
3 x 4 dientes



B408510
15 cm - 6"



B408512
15 cm - 6"



B408511
15 cm - 6"



B408515
12 cm - 4^{3/4}"



B408526
16 cm - 6^{1/4}"

Pinces à dissection délicates - Delicate dissecting forceps - Pinzas para disección delicadas

WISE

Droite	Courbe
Straight	Curved
Recta	Curva

12 cm - 4³/₄"

B408801

-

13,5 cm - 5¹/₄"

B408802

B408804



OSCHNER

PINCE À LIGATURE
LIGATURE FORCEPS
PINZA PARA HILO



B408810

14,5 cm - 5³/₄"

AUSTIN

PINCE MICRO-TUBAIRE
MICRO-TUBAL FORCEPS
PINZA MICROTUBARICA



B408821

18 cm - 7"

MICRO-PINCE À SUTURE 0,3 MM
SUTURE MICRO FORCEPS 0.3 MM
MICRO PINZA PARA SUTURA 0,3 MM

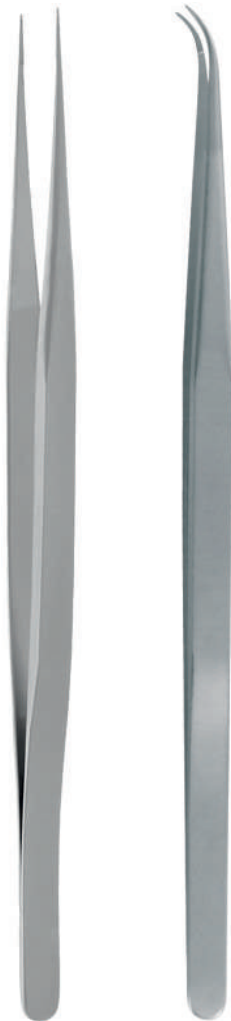

B408802

13,5 cm - 5¹/₄"

B408804

13,5 cm - 5¹/₄"

TRÈS FINE - VERY FINE - MUY FINA

18,5 cm - 7 1/4"

B408830



20 cm - 8"

B408831

Sans griffes
Without teeth
Sin dientes



Sans griffes
Lisses
Without teeth
Smooth
Sin dientes
Lissa

B408830

18,5 cm - 7 1/4"

Sans griffes
Without teeth
Sin dientes

1 x 2 griffes
1 x 2 teeth
1 x 2 dientes



Lisses
Smooth
Lissa

Baïonnette
Bayonet
Bayoneta

B408835

16 cm - 6 1/4"

B408836

16 cm - 6 1/4"

Baïonnette
Bayonet
Bayoneta



Lisses
Smooth
Lissa

B408838

18,5 cm - 7 1/4"



DUMONT

PINCE D'HORLOGER - WATCH MAKER'S FORCEPS - PINZA DE RELOJERO



N° 1

B408701
11 cm - 4¹/₄"



N° 3

B408703
11 cm - 4¹/₄"



N° 4

B408704
11 cm - 4¹/₄"



N° 5

B408705
11 cm - 4¹/₄"



N° 7

B408707
11 cm - 4¹/₄"

À ÉPILER - FOR EPILATION - PARA DEPILACIÓN



B408010
8 cm - 3"



B408020
8 cm - 3"



B408030
8 cm - 3"

Pinces à dissection ophtalmologiques - Ophthalmologic dissecting forceps - Pinzas para disección oftalmológicas

II - Dissection
II - Dissecting
II - Disección



Sans
griffes
Without
teeth
Sin
dientes

I150880
10,5 cm - 4 1/4"



Sans
griffes
Without
teeth
Sin
dientes

I150881
10,5 cm - 4 1/4"



I150882
10,5 cm - 4 1/4"



1 x 2
griffes
1 x 2
teeth
1 x 2
dientes

I150885
10,5 cm - 4 1/4"



1 x 2
griffes
1 x 2
teeth
1 x 2
dientes

I150886
10,5 cm - 4 1/4"



I150887
10,5 cm - 4 1/4"



Sans griffes
Mors 8/10
Without teeth
8/10 jaws
Sin dientes
Bocas 8/10

I150890
10 cm - 4"



I150895
10 cm - 4"



Sans
griffes
Without
teeth
Sin
dientes

B40840
11 cm - 4 1/4"



I15120
11 cm - 4 1/4"



1 x 2
griffes
1 x 2
teeth
1 x 2
dientes

B40830
11 cm - 4 1/4"



I15110
11 cm - 4 1/4"

PRECELLE

PERRY



B408250
12 cm - 4^{3/4}"

Sans griffes
Without teeth
Sin dientes



B408110
16 cm - 6^{1/4}"

1 x 2 griffes
1 x 2 teeth
1 x 2 dientes



B40810
16 cm - 6^{1/4}"



B40820
16 cm - 6^{1/4}"



B408210
20 cm - 8"

II - Dissection
II - Dissecting
II - Disección

Pinces à dissection O.R.L - ENT dissecting forceps - Pinzas para disección O.R.L.

TROELTSCH

12 cm - 4 ³/₄" **I150490**

14 cm - 5 ¹/₂" **I15050** 

17 cm - 6 ³/₄" **I150501**



Sans griffes
Mors striés
Without teeth
Serrated jaws
Sin dientes
Bocas estriadas

I15050
14 cm - 5 ¹/₂"

14 cm - 5 ¹/₂" **I150504** 

17 cm - 6 ³/₄" **I150505**



Sans griffes
Mors fins striés
Without teeth
Fine jaws serrated
Sin dientes
Bocas fines estriadas

I150504
14 cm - 5 ¹/₂"

14 cm - 5 ¹/₂" **I150502** 

17 cm - 6 ³/₄" **I150503**



Sans griffes
Mors lisses
Without teeth
Smooth jaws
Sin dientes
Bocas lisas

I150502
14 cm - 5 ¹/₂"

12 cm - 4 ³/₄" **I150590**

14 cm - 5 ¹/₂" **I15060** 

17 cm - 6 ³/₄" **I150601**



1 x 2 griffes
1 x 2 teeth
1 x 2 dientes

I15060
14 cm - 5 ¹/₂"

14 cm - 5 ¹/₂" **I150602** 

17 cm - 6 ³/₄" **I150603**



1 x 2 griffes
Mors fins
1 x 2 teeth
Fine jaws
1 x 2 dientes
Bocas finas

I150602
14 cm - 5 ¹/₂"

14 cm - 5 ¹/₂" **I150604** 

17 cm - 6 ³/₄" **I150605**



Mors cuillères
Spoon jaws
Bocas cucharas

I150604
14 cm - 5 ¹/₂"

POLITZER



Sans griffes
Mors striés
Without teeth
Serrated jaws
Sin dientes
Bocas estriadas

I150610
12 cm - 4³/₄"



1 x 2 griffes
1 x 2 teeth
1 x 2 dientes

I150611
12 cm - 4³/₄"



Mors cuillères
Spoon jaws
Bocas cucharas

I150612
12 cm - 4³/₄"



Pinces à dissection O.R.L - ENT dissecting forceps - Pinzas para disección O.R.L.

II - Dissection
II - Dissecting
II - Disección

JANSEN (LUCAE)

Sans griffes
Without teeth
Sin dientes

1 x 2 griffes
1 x 2 teeth
1 x 2 dientes

	I150444	16 cm - 6 1/4"	I150441	
	I150445	18 cm - 7"	I150442	
	I150446	21 cm - 8 1/4"	I150443	

LUCAE

Sans griffes
Mors striés
Without teeth
Serrated jaws
Sin dientes
Bocas estriadas

1 x 2 griffes
1 x 2 teeth
1 x 2 dientes

Mors cuillères
Spoon jaws
Bocas cucharas

Mors striés
Serrated jaws
Bocas estriadas



 **I150620**
14 cm - 5 1/2"
I150640
17 cm - 6 1/2"



I150621
14 cm - 5 1/2"

Baionnette
Bayonet
Bayoneta



I150630
14 cm - 5 1/2"



I150444
16 cm - 6 1/4"

Baionnette
Bayonet
Bayoneta



I150441
16 cm - 6 1/4"

Pinces à dissection vasculaires - Vascular dissecting forceps - Pinzas para disección vasculares



DeBaKey

DEBAKEY

1,5 mm		2,0 mm		2,0 mm	
	C10005	16 cm - 6 ¹ / ₄ "	C10015	16 cm - 6 ¹ / ₄ "	C10030
	C10010	20 cm - 8"	C10020	20 cm - 8"	C10035
	C10012	24 cm - 9 ¹ / ₂ "	C10025	24 cm - 9 ¹ / ₂ "	C10040
	C10013	30 cm - 11 ³ / ₄ "	C10027	30 cm - 11 ³ / ₄ "	C10047

Droite
Straight
Recta



C10005
16 cm - 6¹/₄"

C10010
20 cm - 8"

Droite
Straight
Recta



C10015
16 cm - 6¹/₄"

C10020
20 cm - 8"

Coudée
Angled
Angulada



C10030
16 cm - 6¹/₄"

C10035
20 cm - 8"

Pinces à dissection vasculaires - Vascular dissecting forceps - Pinzas para disección vasculares



DeBakey

DEBAKEY

2,7 mm		3,5 mm	
	C10041	16 cm - 6 1/4"	C10045
	C10042	20 cm - 8"	C10050
	C10043	24 cm - 9 1/2"	C10055
	C10044	30 cm - 11 3/4"	C10057



Cooley

COOLEY

2,0 mm	
16 cm - 6 1/4"	C10765
20 cm - 8"	C10770



C10041
16 cm - 6 1/4"



C10042
20 cm - 8"



C10045
16 cm - 6 1/4"



C10050
20 cm - 8"



C10770
20 cm - 8"

Pinces à dissection vasculaires - Vascular dissecting forceps - Pinzas para disección vasculares



DeBaKey



DEBAKEY GERALD

15 cm - 6" **1,2 mm**
C100580 
 18 cm - 7" **C100581**

DEBAKEY DIETRICH

16 cm - 6^{1/4}" **1,5 mm**
C100582 
 20 cm - 8" **C100583**
 24 cm - 9^{1/2}" **C100584**

DEBAKEY

15 cm - 6" **1,2 mm**
C100590 
 20 cm - 8" **1,5 mm**
C100595 
 24 cm - 9^{1/2}" **C100596**
 30 cm - 11^{3/4}" **C100597**



C100580
15 cm - 6"



C100582
16 cm - 6^{1/4}"



C100590
15 cm - 6"



C100595
20 cm - 8"

Pinces à dissection mors tungstène - Dissecting forceps with tungsten jaws - Pinzas para disección boca de tungsteno



DeBakey

DEBAKEY



TC Inserts

1,5 mm		2,0 mm		2,7 mm		3,5 mm	
	C100010	15 cm - 6"	C100020		C100030	15 cm - 6"	C100040
	C100011	20 cm - 8"	C100021		C100031	20 cm - 8"	C100041
	C100012	24 cm - 9 ¹ / ₂ "	C100022		C100032	24 cm - 9 ¹ / ₂ "	C100042



C100011
20 cm - 8"



C100021
20 cm - 8"



C100031
20 cm - 8"



C100041
20 cm - 8"

Pinces à dissection mors tungstène - Dissecting forceps with tungsten jaws - Pinzas para disección boca de tungsteno



STANDARD
STANDARD
ESTÁNDAR

OEHLER

WANGENSTEEN

EVANS

B40610	14 cm - 5 1/2"	B406810
B40620	16 cm - 6 1/4"	B406811
B40640	18 cm - 7"	B406812
B40650	20 cm - 8"	B406813
B40660	25 cm - 10"	B406814
B40670	30 cm - 11 3/4"	B406815

15 cm - 6"	B406910
23 cm - 9"	B406911
25 cm - 10"	B406912



1 x 2 griffes
1 x 2 teeth
1 x 2 dientes



B40640
18 cm - 7"



B406812
18 cm - 7"



B406911
23 cm - 9"



B407900
25 cm - 9 3/4"





POTTS-SMITH

CUSHING

GRUENWALD

- 15 cm - 6" B407550
- 18 cm - 7" B40760
- 21 cm - 8¹/₄" B40770
- 23 cm - 9" B407750
- 25 cm - 10" B40780



B40760
18 cm - 7"



B40750
18 cm - 7"



B407510
18 cm - 7"



B407520
18,5 cm - 7¹/₄"

Baïonnette
Bayonet
Bayoneta

1,8 mm

LANDANGER

Pinces à dissection mors tungstène - Dissecting forceps with tungsten jaws - Pinzas para disección boca de tungsteno



TC Inserts

ADSON

MICRO ADSON

	B40600	12 cm - 4 ^{3/4} "	B406001	
	B406010	15 cm - 6"	B406011	

12 cm - 4 ^{3/4} "	B406020	
15 cm - 6"	B406021	

Sans griffes
Without teeth
Sin dientes

1 x 2 griffes
1 x 2 teeth
1 x 2 dientes

1 x 2 griffes
1 x 2 teeth
1 x 2 dientes

SEMKEN

MC INDOE

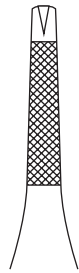
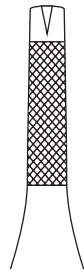

B40600
12 cm - 4^{3/4}"



B406001
12 cm - 4^{3/4}"



B406020
12 cm - 4^{3/4}"



B406950
15 cm - 6"



B406960
15 cm - 6"



II - Dissection
II - Dissecting
II - Disección

Prestige

II - Dissection
II - Dissecting
II - Disección

Sans griffes
Without teeth
Sin dientes

1 x 2 griffes
1 x 2 teeth
1 x 2 dientes



B86715
14 cm - 5 1/2"



B86720
16 cm - 6 1/4"



B86725
18 cm - 7"



B86700
14 cm - 5 1/2"



B86705
16 cm - 6 1/4"



B86710
18 cm - 7"

Prestige

VINCENT

MODÈLE FIN
FINE MODEL
MODELO FINO

Sans griffes
Without teeth
Sin dientes



B86735
14 cm - 5 1/2"

1 x 2 griffes
1 x 2 teeth
1 x 2 dientes



B86730
14 cm - 5 1/2"

Sans griffes
Without teeth
Sin dientes



B86745
20 cm - 8"

1 x 2 griffes
1 x 2 teeth
1 x 2 dientes



B86740
20 cm - 8"

II - Dissection
II - Dissecting
II - Disección



BARRAYA

ADLERKREUTZ

DURAND (PATTE DE VELOURS)

16 cm - 6¹/₄"

B86750

18 cm - 7"

B86755 

20 cm - 8"

B86760

16 cm - 6¹/₄"

B86765

18 cm - 7"

B86770 

20 cm - 8"

B86775

15 cm - 5³/₄"

B86780 

20 cm - 8"

B86785



2 x 3 griffes
Mors étroits quadrillés
2 x 3 teeth
Narrow jaws squared
2 x 3 dientes
Boca estrecha cuadriculada

B86755
18 cm - 7"



3 x 4 griffes
à talon
3 x 4 teeth
With heel
3 x 4 dientes
Con talón

B86770
18 cm - 7"



B86780
15 cm - 5³/₄"

Pinces à échardes - Splinters forceps - Pinzas para astillas



Lisse
Smooth
Liso



B410021
11,5 cm - 4¹/₂"



Strié
Serrated
Estriado



B410041
11,5 cm - 4¹/₂"



B40800
10 cm - 4"



B408040
10 cm - 4"

FEILCHENFELD

HUNTER

WALTER-CARMALT

7,5 cm - 3"

B410100

9 cm - 3¹/₂"

B410101



11,5 cm - 4¹/₂"

B410102



B410101
9 cm - 3¹/₂"



B410110
10,5 cm - 4"



B410111
10,5 cm - 4"



B410120
10,5 cm - 4"



B410121
10,5 cm - 4"

PEET

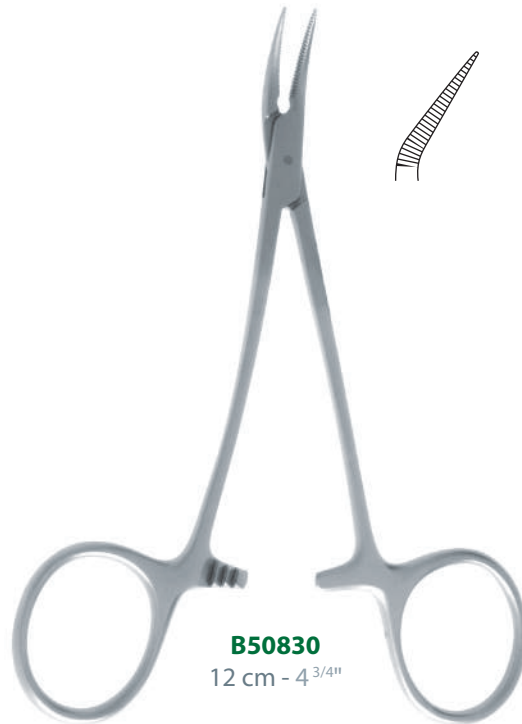

B50830
12 cm - 4 ³/₄"

STIEGLITZ

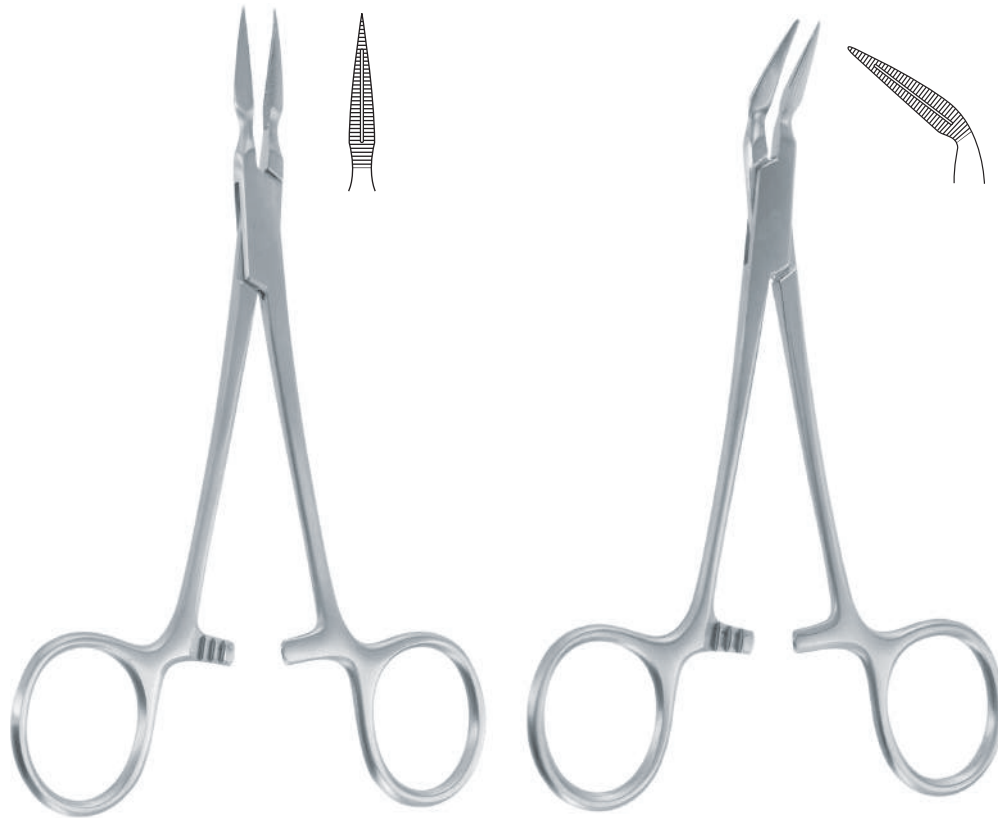

B508310
13,5 cm - 5 ¹/₄"

B508311
13,5 cm - 5 ¹/₄"

Ciseaux chirurgicaux - Surgical scissors - Tijeras quirúrgicas

Mousse-Mousse
Blunt-Blunt
Roma-Roma

Pointu-Pointu
Sharp-Sharp
Aguda-Aguda

DAUPHIN



P 9



P 10



P 11

Ciseaux délicats - Delicate scissors - Tijeras delicadas

Strabisme
Strabismus
Estrabismo

DAUPHIN

Cataracte
Cataract
Catarata

Enucléation
Enucleation
Enucleación

GRAZIL

ALLAIRE

KILNER
(RAGNELL)

Ciseaux fins - Fine scissors - Tijeras finas

WAGNER

DEAVER

MIXTER



P 12



P 12



P 12



P 13



P 13



P 13



P 15



P 15



P 15



P 14



P 14



P 14

Ciseaux à dissection - Dissecting scissors - Tijeras para disección

MAYO

MAYO-STILLE

MAYO-ALSACE

MAYO-LEGER

MAYO-LYON

MAYO-NOBLE

MAYO-SANTY

MAYO-HARRINGTON

DUBOST



P 16



P 17



P 18



P 18



P 18



P 19



P 19



P 19



P 20

BABY-LEXER LEXER LEXER-FINO

METZENBAUM

METZENBAUM-FINO

ALLAINE

ALLAINE (BOYD)



P 21



P 21



P 21



P 22



P 23



P 23



P 24



P 24



P 24



P 25



P 25



P 26

Ciseaux divers - Miscellaneous scissors - Tijeras diversas

NANCY DOYEN



P 27



P 27

Ciseaux à incision - Incision scissors - Tijeras para incisión

RICHTER

HI-LEVEL
KNOWLES

KNOWLES

FERGUSON



P 28



P 28



P 28



P 28

Ciseaux à pansements - Bandage scissors - Tijeras para vendajes

LISTER LISTER-EXCENTRIC ESMARCH BERGMANN

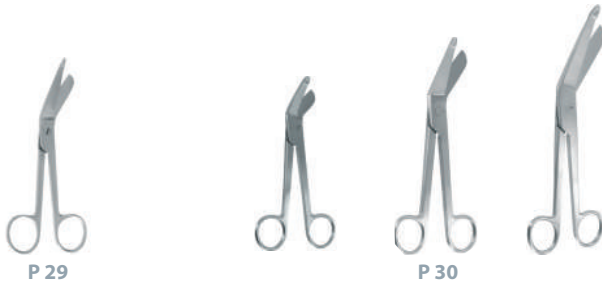

Ciseaux pour couper les fils - Wire cutting scissors - Tijeras para cortar hilos

HARVEY UNIVERSEL BEEBE EISELSBERG SCHOEMAKER-LOTH



Ciseaux pour chirurgie vasculaire - Scissors for vascular surgery - Tijeras para cirugía vascular

POTTS-SMITH DEBAKEY HEGEMANN (DIETRICH) POTTS DE MARTEL MILLS VINCENT (SCHMIEDEN) POTTS-SMITH DEBAKEY FAVALORO

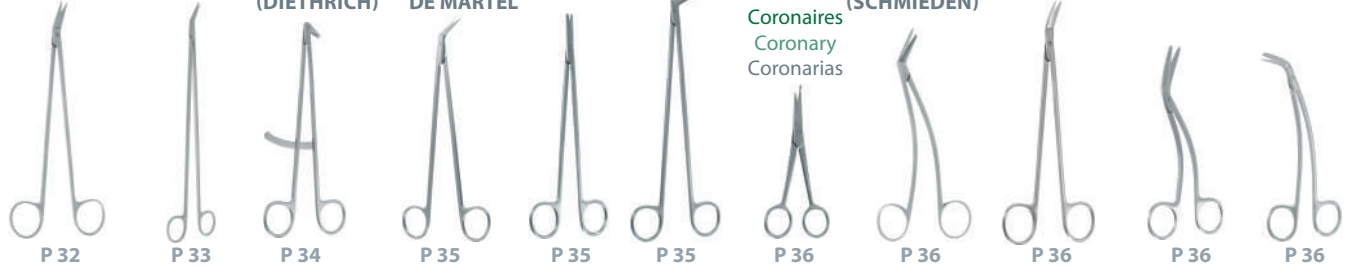

Ciseaux divers - Various scissors - Tijeras diversas

BOETTCHER PRINCE GOOD MARTIN-CARTILAGE MCINDOE POTTS-SMITH

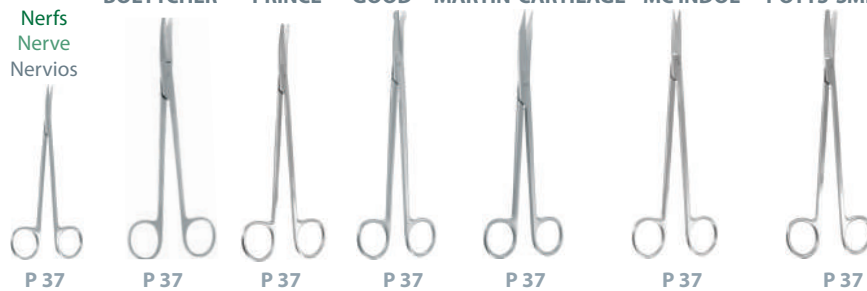

Ciseaux fins - Fine scissors - Tijeras finas

LA GRANGE KNAPP MICRO



Ciseaux fins - Fine scissors - Tijeras finas

GRAEFE WILMER Strabisme Strabismus Estrabismo CHADWICK BONN WALTON



Ciseaux coupe ligatures - Ligature cutting scissors - Tijeras para cortar ligaduras

SPENCER LITTLER LITTAUER SPENCER-FINO

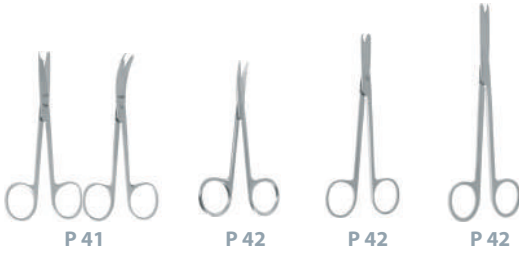

Ciseaux fins - Fine scissors - Tijeras finas

STEVENS RIBBON TYPE GOLDMANN-FOX LOCKLIN

Gencives
Gingiva
Encía

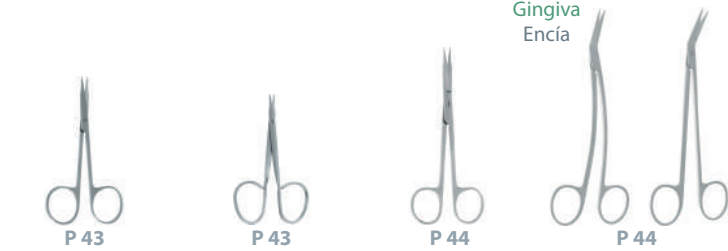

Ciseaux divers - Miscellaneous scissors - Tijeras diversas

DEAN QUINBY LANDOLT

Enucléation
Enucleation
Enucleación

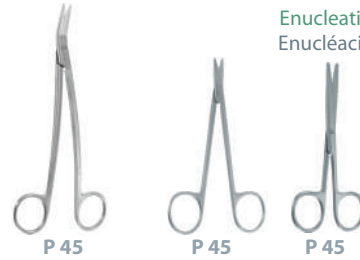

Ciseaux longs et fins - Long and fine scissors - Tijeras largas y finas

JAMESON REYNOLDS TOENNIS TOENNIS-ADSON TOENNIS-ADSON -FINO KELLY STRULLY SANVENERO BROPHY (SULLIVAN)

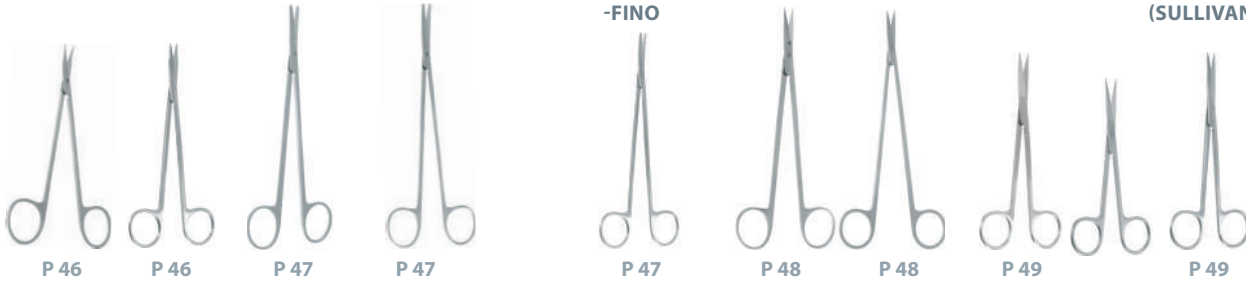

Ciseaux divers - Miscellaneous scissors - Tijeras diversas

KLIKENBERG SATINSKY SIEBOLD



Ciseaux pour intervention en profondeur -

Scissors for deep operations - Tijeras para intervención a fondo

CRAFOORD DUBOIS SIMS WERTHEIM



Ciseaux divers - Miscellaneous scissors - Tijeras diversas

Coiffeur
Hairdresser
Peluquero

Colleuse
Gluer
Encolador

Lingère
Lingere
Lencera

Couturière
Dressmaker
Modista

ROUENNAIS

JESCO



Ciseaux en tungstène - Tungsten scissors - Tijeras de tungsteno

KILNER KELLY (RAGNELL) MAYO MAYO-LEXER LEXER-FINO MAYO-STILLE MAYO-LEXER LEXER-FINO MAYO-STILLE



METZENBAUM METZENBAUM-FINO TOENNIS-ADSON GOLDMANN FOX UNIVERSEL LISTER DUBOST KLIKENBERG SIMS POTTS-SMITH DEBAKEY



Ciseaux Prestige - Prestige scissors - Tijeras Prestige

MAYO MAYO-STILLE MAYO-LEXER BABY-METZENBAUM METZENBAUM METZENBAUM -FINO WAGNER STEVENS REYNOLDS JAMESON



POTTS-SMITH MERVEILLEUX SIMS JOSEPH KAYE GORNEY FOMON COTTLE HEYMANN



Ciseaux pour le cordon ombilical - Scissors for umbilical cord - Tijeras para el cordón umbilical

BUSCH USA SCHUMACHER



Ciseaux à épisiotomie - Episiotomy scissors - Tijeras para episiotomía

DELESTRE BRAUN-STADLER WALDMANN



Ciseaux ORL - ENT scissors - Tijeras ORL

JOSEPH FOMON HALLE FOMON COTTLE HEYMANN

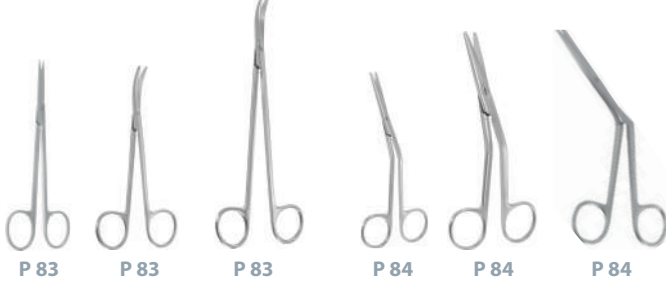

Instruments pour plâtres - Plaster instruments - Instrumentos para escayolas

BRUNS LANGE



Ciseaux pour chirurgie osseuse - Bone surgery scissors - Tijeras para cirugía ósea

Ciseaux à décapsuler
Scissors to uncap
Tijeras para decapsular



Ciseaux à ménisque
Meniscus scissors
Tijeras para menisco



Ciseaux divers - Miscellaneous scissors - Tijeras diversas

SMITH

Ciseaux enterotome
Enterotome scissors
Tijeras enterotomo

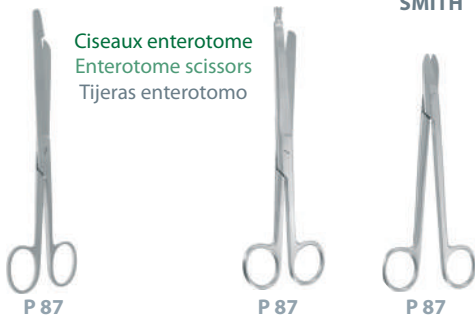

Ciseaux à ongles - Nails scissors - Tijeras para uñas

Ciseaux à fendre les ongles
Nail splitting scissors
Tijeras para hender las uñas



Instruments pour prostate - Instruments for prostate - Instrumentos para prostate

VIII - Voies basses
VIII - Gyne/Uro/Procto
VIII - Gyne/Uro/Procto

METZENBAUM



P 95

Microchirurgie ciseaux - Microsurgery scissors - Microcirugía tijeras

X - Microchirurgie
X - Microsurgery
X - Microcirugía

WESTCOTT



P 3

VANNAS



P 4

VANNAS modifié TÜBINGEN



P 4

CASTROVIEJO



P 5

CASTROVIEJO



P 5

TROUTMAN-BARRAQUER



P 5

NOYES



P 6

WECKER



P 6

TROUTMAN



P 7

KATZIN BARRAQUER



P 7

KATZIN



P 7

WESTCOTT



P 7

CASTROVIEJO

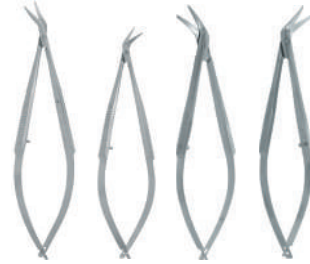

P 8

VANNAS MILLESI



P 9

VANNAS



P 10

YASARGIL



P 11

Instrumentation de service - Instrumentation for services - Instrumentación de servicio

XV - Divers
XV - Miscellaneous
XV - Diversos

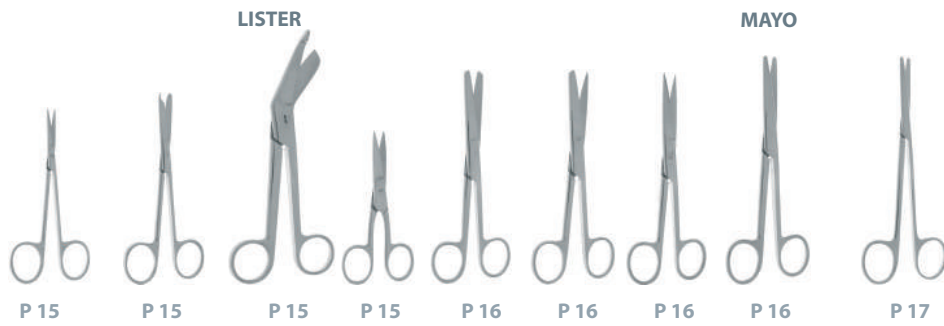

Ciseaux pour plâtre - Plaster scissors - Tijeras para escayolas

XV - Divers
XV - Miscellaneous
XV - Diversos



Matériels divers - Miscellaneous materials - Materiales varios

XV - Divers
XV - Miscellaneous
XV - Diversos

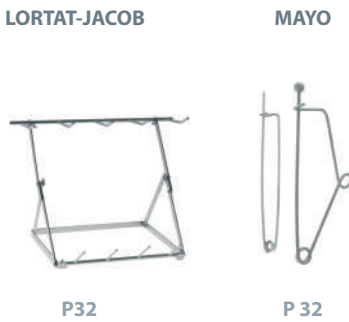

III - Ciseaux
III - Scissors
III - Tijeras

LANDANGER

Ciseaux chirurgicaux - Surgical scissors - Tijeras quirúrgicas

	Droit Straight Recta		Courbe Curved Curva
	B25255	11 cm - 4 1/4"	B25260
	B25261	13 cm - 5"	B25262 
	B25275	14 cm - 5 1/2"	B25280
	B25285	16 cm - 6 1/4"	B25290
	B25295	18 cm - 7"	B25300
	B25302	20 cm - 8"	B25303

Mousse / Mousse
Blunt / Blunt
Roma / Roma



B25261
13 cm - 5"



B25262
13 cm - 5"

III - Ciseaux
III - Scissors
III - Tijeras

Ciseaux chirurgicaux - Surgical scissors - Tijeras quirúrgicas

	Droit Straight Recta			Courbe Curved Curva
	B25305	11 cm - 4 1/4"		B25310
	B25311	13 cm - 5"		B25312 
	B25325	14 cm - 5 1/2"		B25330
	B25335	16 cm - 6 1/4"		B25340
	B25345	18 cm - 7"		B25350
	B253470	20 cm - 8"		B253520

Pointu / Pointu
Sharp / Sharp
Aguda / Aguda



B25311
13 cm - 5"



B25312
13 cm - 5"

DAUPHIN

Droit Straight Recta		Courbe Curved Curva
	B25355 11 cm - 4 1/4"	B25360
	B25365 13 cm - 5"	B25370 
	B25375 14 cm - 5 1/2"	B25380
	B25385 16 cm - 6 1/4"	B25390
	B25395 18 cm - 7"	B25400
	B253970 20 cm - 8"	B254010

Pointu / Mousse
Sharp / Blunt
Aguda / Roma



B25365
13 cm - 5"



B25370
13 cm - 5"

Ciseaux délicats - Delicate scissors - Tijeras delicadas

STRABISME
STRABISMUS
ESTRABISMO

Droit	Courbe
Straight	Curved
Recta	Curva

12 cm - 4^{3/4}"  **B25265** **B25270**

CATARACTE
CATARACT
CATARATA

Droit	Courbe
Straight	Curved
Recta	Curva

 **B25315** **B25320**

Droit	Courbe
Straight	Curved
Recta	Curva

 **B253680** **B253730**

DAUPHIN

Mousse / Mousse
Blunt / Blunt
Roma / Roma

Pointu / Mousse
Sharp / Blunt
Aguda / Roma

Pointu / Pointu
Sharp / Sharp
Aguda / Aguda



B25270

B25265

12 cm - 4^{3/4}"



B253730

B253680

12 cm - 4^{3/4}"



B25320



B25315

12 cm - 4^{3/4}"



ÉNUCLÉATION ENUCLEATION ENUCLEACIÓN

GRAZIL

	Droit Straight Recta	Courbe Curved Curva		Droit Straight Recta	Courbe Curved Curva		Droit Straight Recta	Courbe Curved Curva
13 cm - 5" 	B25402	B25403		B254021	B254031		B254022	B254032
14,5 cm - 5 ^{3/4} "	B25405	B25410		B254051	B254101		B254052	B254102

Mousse / Mousse
Blunt / Blunt
Roma / Roma

Pointu / Mousse
Sharp / Blunt
Aguda / Roma

Pointu / Pointu
Sharp / Sharp
Aguda / Aguda



B25403



B254031



B254032

B25402
13 cm - 5"

B254021
13 cm - 5"

B254022
13 cm - 5"



WAGNER



DEAVER



MIXTER



Ciseaux délicats - Delicate scissors - Tijeras delicadas

ALLAIRE

Droit
Straight
Recta

Courbe
Curved
Curva

13 cm - 5"

B25415



B25418

KILNER (RAGNELL)

Courbe
Curved
Curva

12 cm - 4 3/4"

B25421



13 cm - 5"

B254220

15 cm - 6"

B25426

Spatulé
Spatula
Espatula







B25418

B25415
13 cm - 5"



B25421
12 cm - 4 3/4"

MAYO

		Droit Straight Recta		Courbe Curved Curva				
 Gaucher Left-handed Zurdo	L	B25483L	B25483 	15 cm - 6"		B25485	B25485L L	 Gaucher Left-handed Zurdo
	L	B25486L	B25486	17 cm - 6 ³ / ₄ "		B25489	B25489L L	
			B254891	19 cm - 7 ¹ / ₂ "		B254892		
			B254893	23 cm - 9"		B254894		
			B255100	28 cm - 11"		B255101		

Lames plates
Flat blades
Hojas planas







B25483
15 cm - 6"



B25485
15 cm - 6"

MAYO-STILLE

		Droit Straight Recta			Courbe Curved Curva		
 Gaucher Left-handed Zurdo	L	B25490L	B25490	15 cm - 6"	B25495	B25495L	L
	L	B25497L	B25497 	17 cm - 6 3/4"	 B25498	B25498L	L
			B254981	19 cm - 7 1/2"	B254982		
			-	21 cm - 8 1/4"	B254983		
							 Gaucher Left-handed Zurdo



B25497
17 cm - 6 3/4"

B25498
17 cm - 6 3/4"

Ciseaux à dissection - Dissecting scissors - Tijeras para disección

MAYO-ALSACE

Droit
Straight
Recta

Courbe
Curved
Curva

16 cm - 6¹/₄"

B25460

B25465



Lames évidées
Hollowed blades
Hojas vaciadas

MAYO-LEGER

Droit
Straight
Recta

Courbe
Curved
Curva

17 cm - 6³/₄"

B25470

B25475



MAYO-LYON

Coudé
Angled
Angulada

14 cm - 5¹/₂"

B25480



B25460
16 cm - 6¹/₄"

B25465



B25470
17 cm - 6³/₄"

B25475



B25480
14 cm - 5¹/₂"

MAYO-NOBLE

Droit
Straight
Recta

Courbe
Curved
Curva

17 cm - 6³/₄"

B255800

B255801



MAYO-SANTY

Droit
Straight
Recta

Courbe
Curved
Curva

24 cm - 9¹/₂"

B25600

B25605



Lames rondes
Round blades
Hojas redondas

MAYO-HARRINGTON

Droit
Straight
Recta

Courbe
Curved
Curva

20 cm - 8"

B25572

B25574

23 cm - 9"

B25576

B25578



B255801

B255800
17 cm - 6³/₄"



B25605

B25600
24 cm - 9¹/₂"



B25578

B25576
23 cm - 9"



DUBOST

	Droit Straight Recta		Courbe Curved Curva	
	B25686	23 cm - 9"	B25688	
	B25692	26 cm - 10 ¹ / ₄ "	B25694	
	B25696	30 cm - 11 ³ / ₄ "	B25700	



B25686
23 cm - 9"



B25688
23 cm - 9"

LANDANGER

Ciseaux à dissection - Dissecting scissors - Tijeras para disección

BABY-LEXER

Droit
Straight
Recta

Courbe
Curved
Curva

10 cm - 4"

B256070

B256071



LEXER

Droit
Straight
Recta

Courbe
Curved
Curva

16 cm - 6¹/₄"

B256080

B256081



LEXER-FINO

Droit
Straight
Recta

Courbe
Curved
Curva

16 cm - 6¹/₄"

B256090

B256091



B256071

B256070
10 cm - 4"



B256081

B256080
16 cm - 6¹/₄"











B256091

B256090
16 cm - 6¹/₄"



III - Ciseaux
III - Scissors
III - Tijeras

METZENBAUM

	Droit Straight Recta			Courbe Curved Curva		
 Gaucher Left-handed Zurdo	 B25610L	B25610			B25615	B25615L 
	 B25620L	B25620 	15 cm - 6"		B25625	B25625L 
	 B25630L	B25630	18 cm - 7"		B25635	B25635L 
		B25640	20 cm - 8"		B25645	
		B25650	23 cm - 9"		B25655	
		B25660	25 cm - 10"		B25665	
		B25670	28 cm - 11"		B25675	
		B25680	30 cm - 11 ³ / ₄ "		B25685	





B25620
15 cm - 6"

Mousse / Mousse
Blunt / Blunt
Roma / Roma



B25625
15 cm - 6"

METZENBAUM

	Droit Straight Recta	Courbe Curved Curva		Droit Straight Recta	Courbe Curved Curva	
	B256201	B256251	15 cm - 6"		B256202	B256252
	B256301	B256351	18 cm - 7"		B256302	B256352
	B256401	B256451	20 cm - 8"		B256402	B256452
	B256501	B256551	23 cm - 9"		B256502	B256552
	B256601	B256651	26 cm - 10 ^{1/4} "		B256602	B256652
	B256701	B256751	28 cm - 11"		B256702	B256752
	B256801	B256851	30 cm - 11 ^{3/4} "		B256802	B256852

Pointu / Mousse
Sharp / Blunt
Aguda / Roma





B256201
15 cm - 6"

Pointu / Pointu
Sharp / Sharp
Aguda / Aguda



B256202
15 cm - 6"

METZENBAUM-FINO

	Droit Straight Recta	Courbe Curved Curva		Droit Straight Recta	Courbe Curved Curva
15 cm - 6" 	B256205	B256255		15 cm - 6" 	B256215 B256265
18 cm - 7"	B256305	B256355			
20 cm - 8"	B256405	B256455			
23 cm - 9"	B256505	B256555			
25 cm - 10"	B256605	B256655			
28 cm - 11"	-	B256760			
28 cm - 11"	-	B256770	WELLER (Lames courtes - Short blades - Lamas cortas)		

Mousse / Mousse
Blunt / Blunt
Roma / Roma



B256205
15 cm - 6"

Pointu / Pointu
Sharp / Sharp
Aguda / Aguda



B256215
15 cm - 6"

B256255
15 cm - 6"

B256265

ALLAINE

	Droit Straight Recta			Courbe Curved Curva	
	B25705	18 cm - 7"		B25706	
	B25715	20 cm - 8"		B25716	
	B25725	23 cm - 9"		B25726	



B25705
18 cm - 7"

B25706
18 cm - 7"

ALLAINE (BOYD)

18 cm - 7"

B25707



20 cm - 8"

B25717



23 cm - 9"

B25727

Double courbure
Double curvature
Doble curvatura

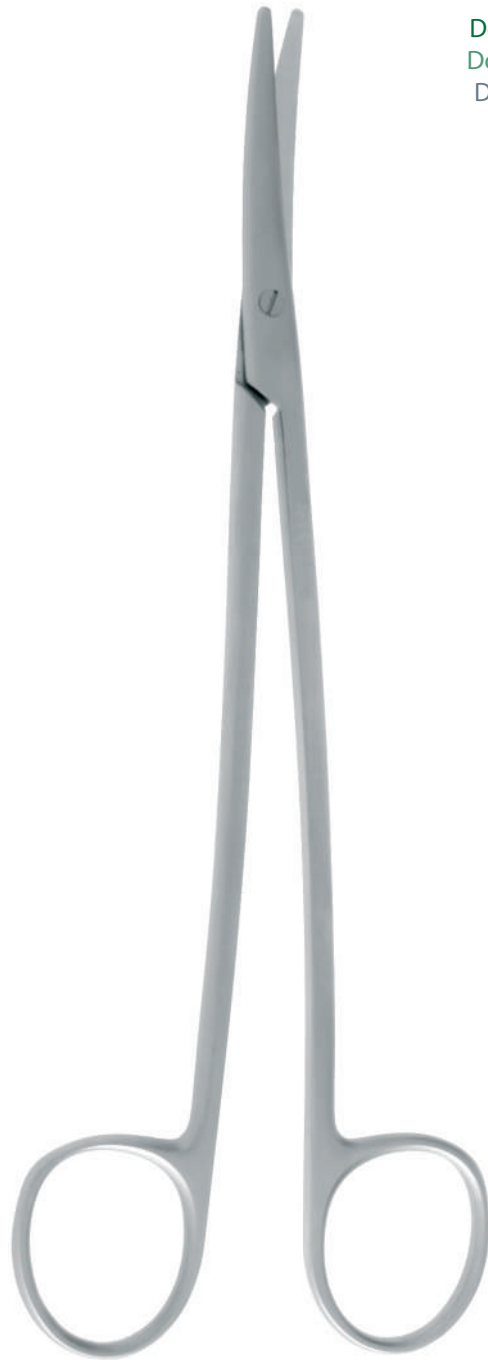

B25707
18 cm - 7"



B25717
20 cm - 8"

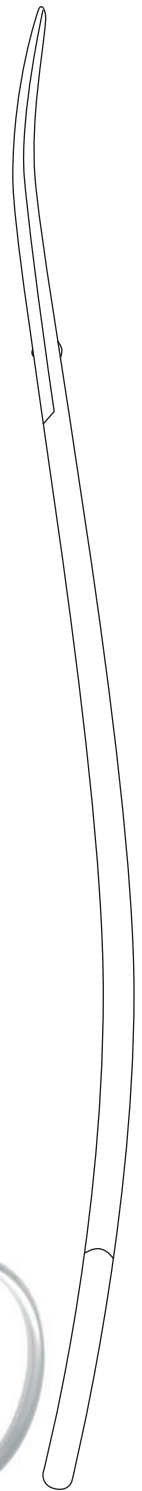

LANDANGER

Ciseaux divers - Various scissors - Tijeras diversas

NANCY

DOYEN

Droit
Straight
Recta

Droit
Straight
Recta

Courbe
Curved
Curva

16 cm - 6 1/4"

B257609

B257614

18 cm - 7" 

B257610

B257615

Courbe
Curved
Curva



B25775
18,5 cm - 7 1/4"



B257605
16 cm - 6 1/4"



B257610
18 cm - 7"



B257615

III - Ciseaux
III - Scissors
III - Tijeras

Ciseaux à incision - Incision scissors - Tijeras para incisión

RICHTER

B257640

13 cm - 5"

B257641 

14,5 cm - 5 3/4"

B257642

16,5 cm - 6 1/2"



B257641

14,5 cm - 5 3/4"

B257645

16,5 cm - 6 1/2"

B257650

14 cm - 5 1/2"

B257651

14,5 cm - 5 3/4"

HI-LEVEL KNOWLES

KNOWLES

FERGUSSON

NEW SUTURE

Coudé
Angular
Angulada



B25770

14 cm - 5 1/2"

B257695

14 cm - 5 1/2"

B257661

18 cm - 7"

B257660

14,5 cm - 5 3/4"

LISTER

- 11,5 cm - 4 1/2" B257350
- 14 cm - 5 1/2" B25745 
- 15,5 cm - 6" B257360
- 18 cm - 7" B25737
- 20 cm - 8" B25740

Croix rouge
Red cross
Cruz roja



B25745
14 cm - 5 1/2"

LORENZ

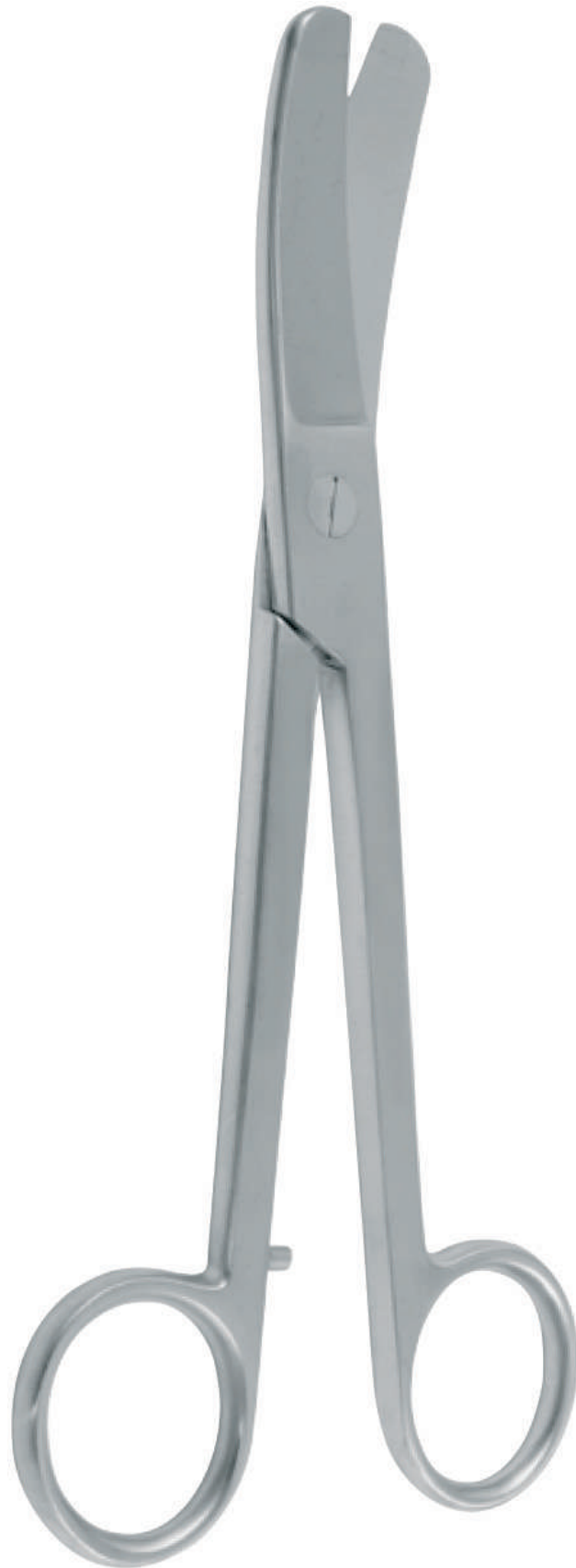

B257300
23 cm - 9"

ESMARCH

20 cm - 8"

B257460



22 cm - 8²/₃"

B257462

LISTER-EXCENTRIC

BERGMANN

Dentelées
Serrated
Serradas



B257340

16 cm - 6 ¹/₄"



B257460

20 cm - 8"



B257465

23,5 cm - 9 ¹/₄"

Ciseaux pour couper les fils - Wire cutting scissors - Tijeras para cortar hilos

HARVEY



B25780
12 cm - 4 3/4"

UNIVERSEL



B25786
12 cm - 4 3/4"

Lames dentelées
Serrated blades
Hojas serradas

BEEBE

	Droit Straight Recta	Courbe Curved Curva
	Pointu - Sharp - Aguda	
10 cm - 4"	B258445	B25845
	Mousse - Blunt - Roma	
10 cm - 4"	-	B258451

Lames dentelées
Serrated blades
Hojas serradas



B25845
10 cm - 4"

EISELSBERG



B258460
11 cm - 4 1/2"

SCHOEMAKER-LOTH



B258465
12,5 cm - 5"

POTTS-SMITH

	25°	45°	60°	125°
19 cm - 7 1/2"	B25802	B25804	B25806	B25812

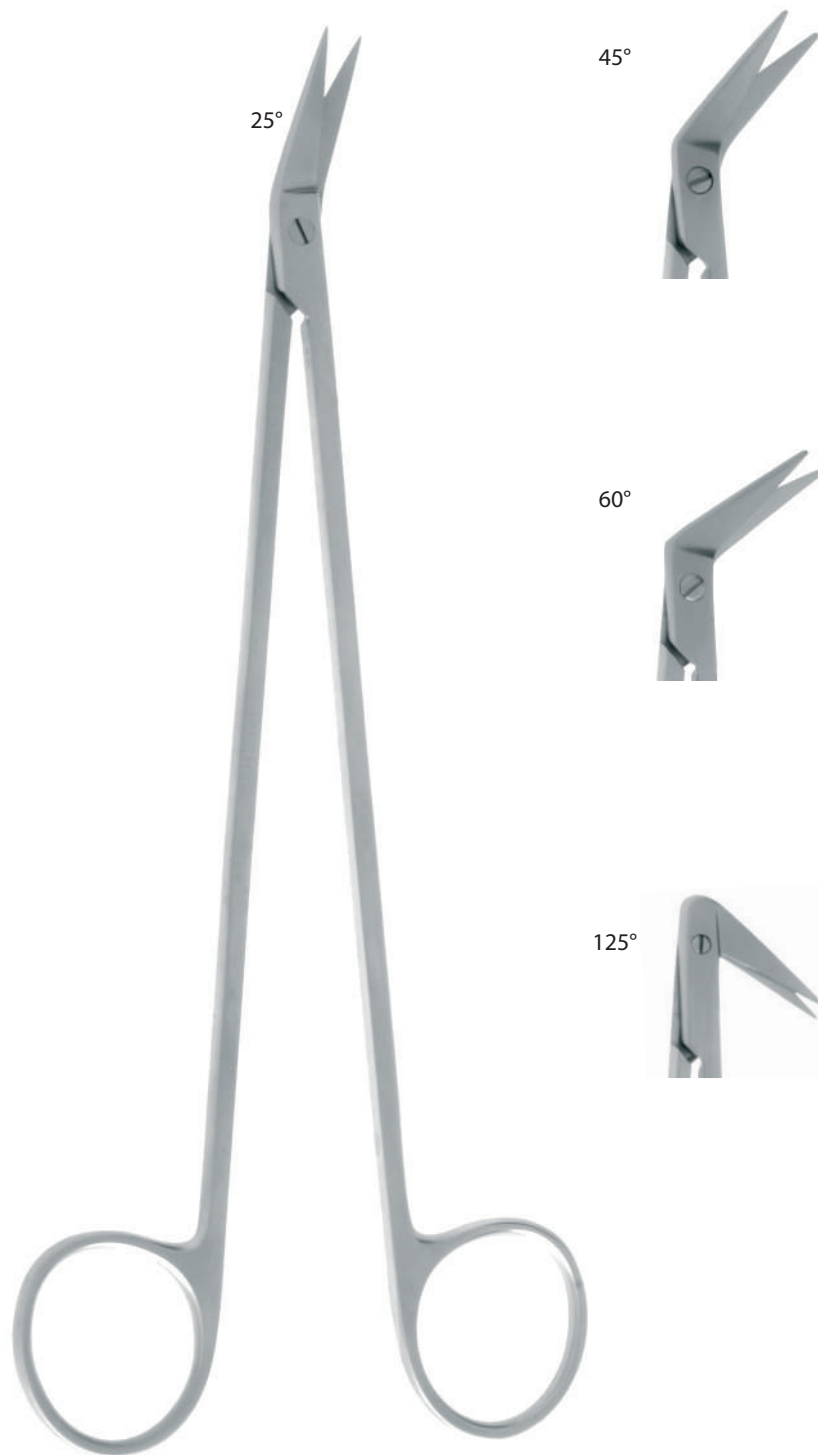

B25802
19 cm - 7 1/2"

III - Ciseaux
III - Scissors
III - Tijeras

DEBAKEY

	25°	45°	60°
16 cm - 7 1/2"	B258023	B258043	B258063
23 cm - 9"	B258024	B258044	B258064
28 cm - 11"	B258025	B258045	B258065

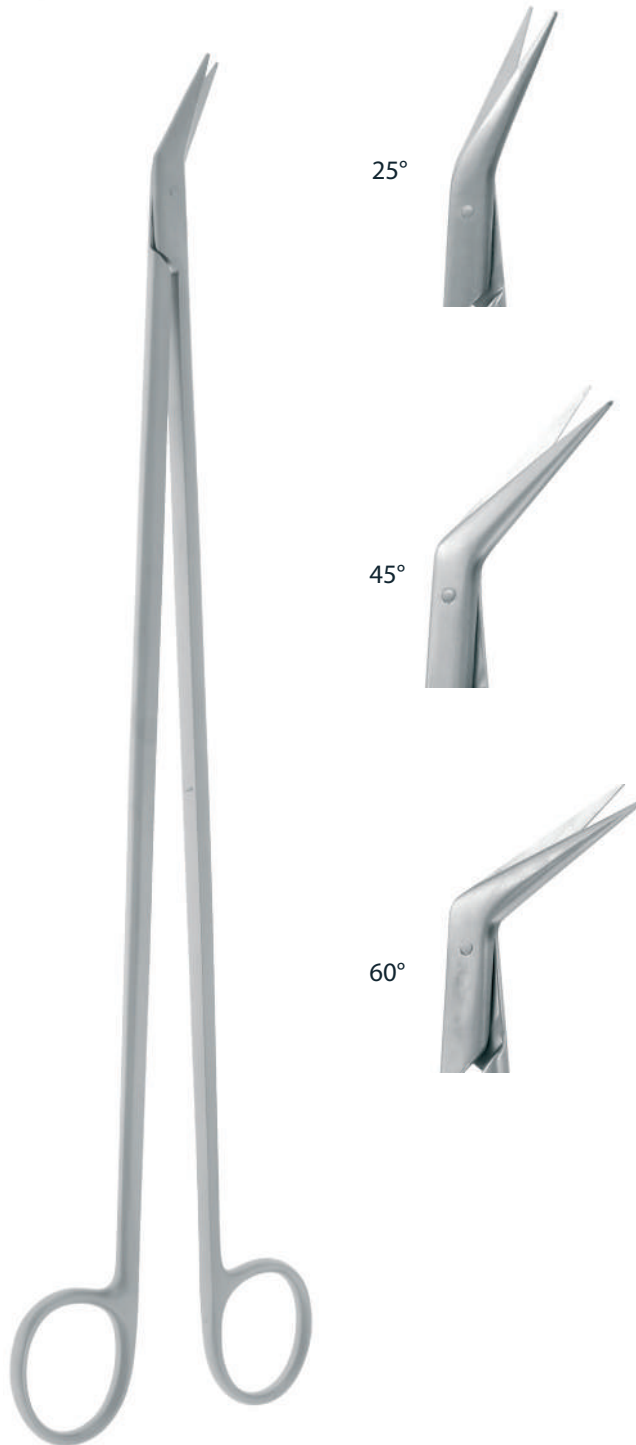

B258025
28 cm - 11"

HEGEMANN (DIETRICH)

	25°	45°	60°	90°	125°	125°
13,5 cm - 5 1/4"	B258027	B258047	B258067	B258107	-	-
16 cm - 6 1/4"	B258028	B258048	B258068	B258108	B258128	-
19 cm - 7 1/2"	B258029	B258049	B258069	B258109	B258129	B258125

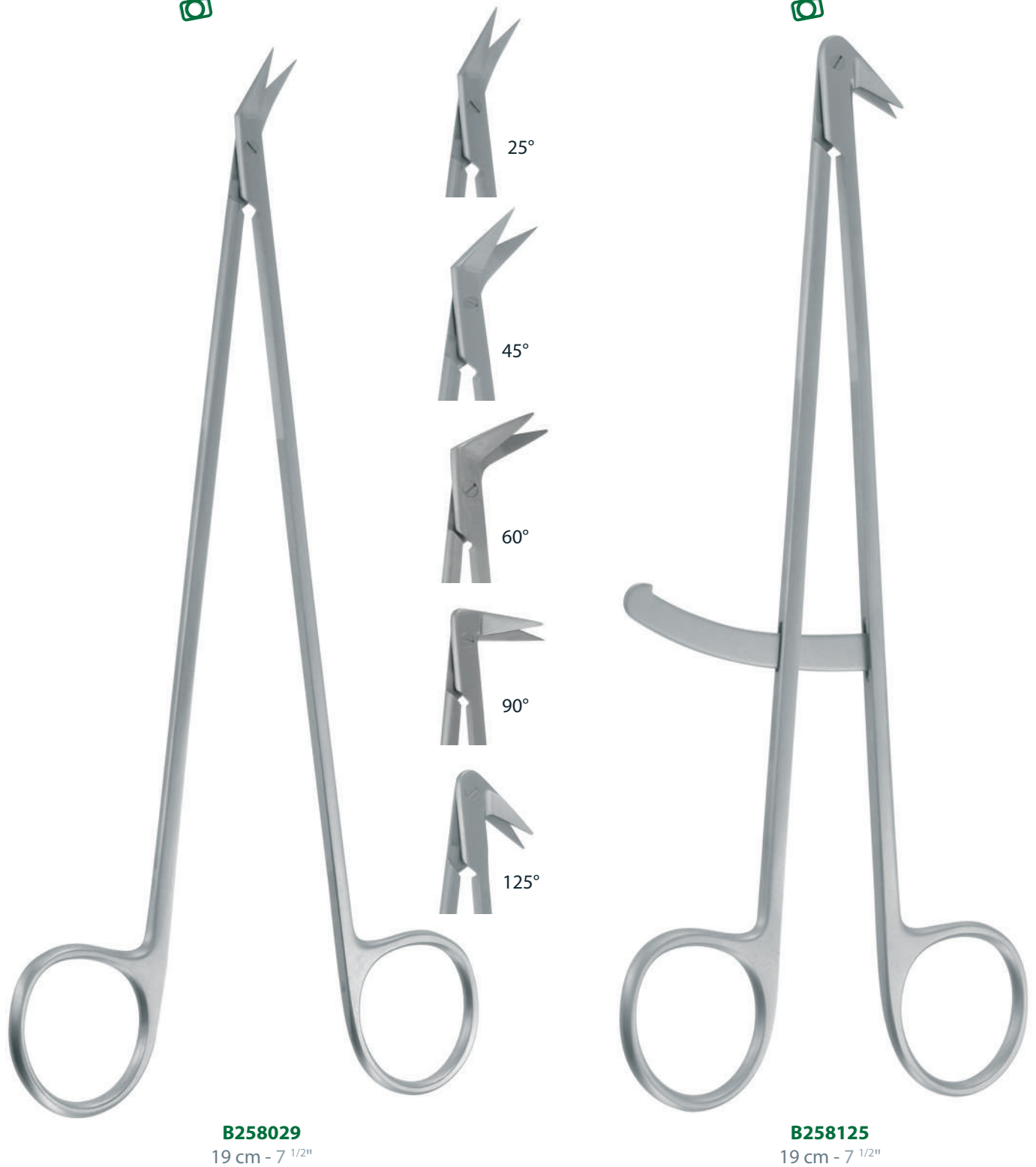

B258029
19 cm - 7 1/2"

B258125
19 cm - 7 1/2"

DE MARTEL

Droit	Courbe
Straight	Curved
Recta	Curva

18 cm - 7"

B25813

B25814



POTTS DE MARTEL

MILLS



60°

B258121
21 cm - 8 1/4"



B25814

B25813
18 cm - 7"

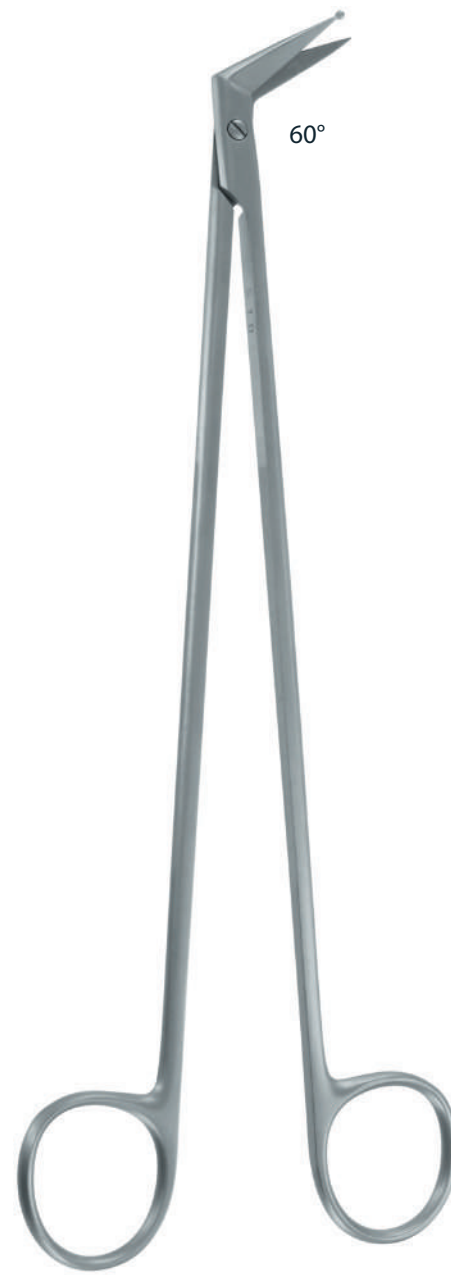

60°

B258123
21 cm - 8 1/4"

III - Ciseaux
III - Scissors
III - Tijeras

CISEAUX CORONAIRES
CORONARY SCISSORS
TIJERAS CORONARIAS



B258155
14,5 cm - 5 3/4"



B258150
11,5 cm - 4 1/2"



B25820
17 cm - 6 3/4"

POTTS-SMITH



B258010
19,5 cm - 7 3/4"

DEBAKEY



B258014
15,5 cm - 6"

FAVALORO



B258015
15,5 cm - 6"



B258016
15 cm - 6"

Ciseaux divers - Various scissors - Tijeras diversas

POUR LES AMYGDALES
TONSIL SCISSORS
PARA AMÍGDALAS

GOOD

CISEAUX POUR LES NERFS
NERVE DISSECTING SCISSORS
TIJERAS PARA NERVIOS

BOETTCHER

PRINCE



B258481
15 cm - 6"



B258491
18 cm - 7"



B258489
17,5 cm - 7"

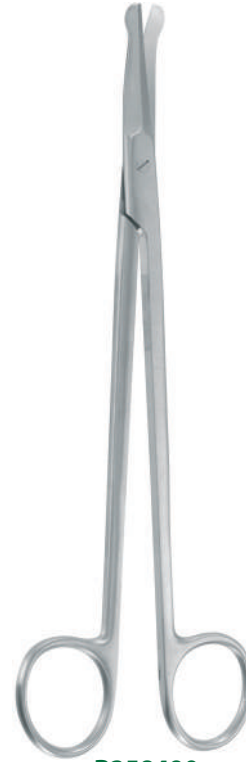

B258490
20 cm - 8"

MARTIN-CARTILAGE

MC-INDOE

POTTS-SMITH

CISEAUX POUR CARTILAGE
CARTILAGE SCISSORS
TIJERAS PARA CARTILAGO

Dentelées
Saw edge
Dentadas



B258483
20 cm - 8"



B258485
20 cm - 8"

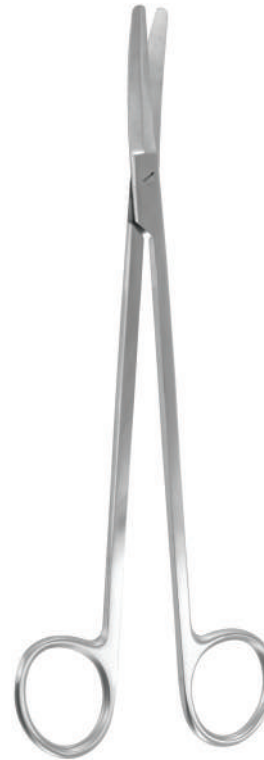

B258487
20 cm - 8"

III - Ciseaux
III - Scissors
III - Tijeras

LA GRANGE

Lames standards
Standard blades
Hojas normales



B258175
11,5 cm - 4 1/2"

Lames dentelées
Serrated blades
Hojas serradas



B258176
11,5 cm - 4 1/2"

KNAPP

Droit	Courbe
Straight	Curved
Recta	Curva

Mousse-Mousse / Blunt-Blunt / Roma-Roma
10,5 cm - 4" **B258180** **B258181**

Pointu-Mousse / Sharp-Blunt / Aguda-Roma
10,5 cm - 4"  **B258182** **B258183**

Pointu-Pointu / Sharp-Sharp / Aguda-Aguda
10,5 cm - 4" **B258184** **B258185**



B258182
10,5 cm - 4"

MICRO

Droit	Courbe
Straight	Curved
Recta	Curva

9 cm - 3 1/2"  **B25816** **B25817**

10,5 cm - 4" **B258161** **B258171**

11,5 cm - 4 1/2" **B258162** **B258172**



B25817



B25816
9 cm - 3 1/2"

GRAEFE

WILMER

CHADWICK

CISEAUX À STRABISME
STRABISMUS SCISSORS
TIJERAS PARA ESTRABISMO



B259800
10,5 cm - 4 1/4"



B259801
10,5 cm - 4 1/4"



B259810
11,5 cm - 4 1/2"



B259820
11 cm - 4 1/3"

B259811

BONN



B259830
11,5 cm - 4 1/2"

Coudé latéral
Lateral angled
Angulada lateral



B259831
11,5 cm - 4 1/2"

Courbé latéral
Lateral curved
Curva lateral



B259841

B259840
9 cm - 3 1/2"



B259850
11 cm - 4 1/3"

B259851



B259910
11,5 cm - 4 1/2"

	Droit Straight Recta	Courbe Curved Curva	Coudé Angled Angulada
10,5 cm - 4 1/4"	B259900	B259901	-
11,5 cm - 4 1/2" 	B259910	B259911	B259915



B259910



B259911



B259915



B259860
10,5 cm - 4 1/4"

Extra plats
Extra flat
Extremadamente planas



B259865
9 cm - 3 1/2"



B259870
10,5 cm - 4 1/4"

WALTON

Courbe
Curved
Curva

SPENCER

Droit
Straight
Recta

Courbe
Curved
Curva

B25825

9 cm - 3 1/2"

B25830



B25835

12 cm - 4 3/4"

B25840



B25835
12 cm - 4 3/4"



B25840
12 cm - 4 3/4"

LITTLER



B258405
11,5 cm - 4 1/2"

LITTAUER

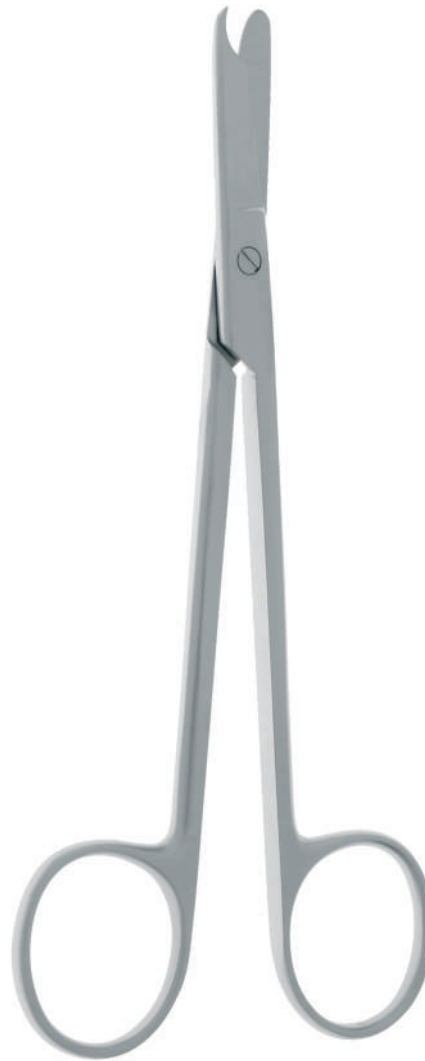

B258410
14 cm - 5 1/2"

SPENCER-FINO



B258415
16 cm - 6 1/4"

STEVENS

Droit
Straight
Recta

Courbe
Curved
Curva



Mousse
Blunt
Roma



B25856

B25857



Pointu
Sharp
Aguda

B25858

B25859



B25856
11 cm - 4 1/4"

STEVENS (RIBBON TYPE)

Droit
Straight
Recta

Courbe
Curved
Curva



B258561

B258571



B258562

B258572



B258561
9,5 cm - 3 1/4"

GOLDMANN-FOX

LOCKLIN

CISEAUX À GENCIVES
GINGIVA SCISSORS
TIJERAS PARA ENCÍA

Droit	Courbe
Straight	Curved
Recta	Curva

13 cm - 5"

B258590

B258591



Lames dentelées
Serrated blades
Hojas serradas

Coudé dentelé
Angled serrated
Angulada serrada



B258591

B258590
13 cm - 5"

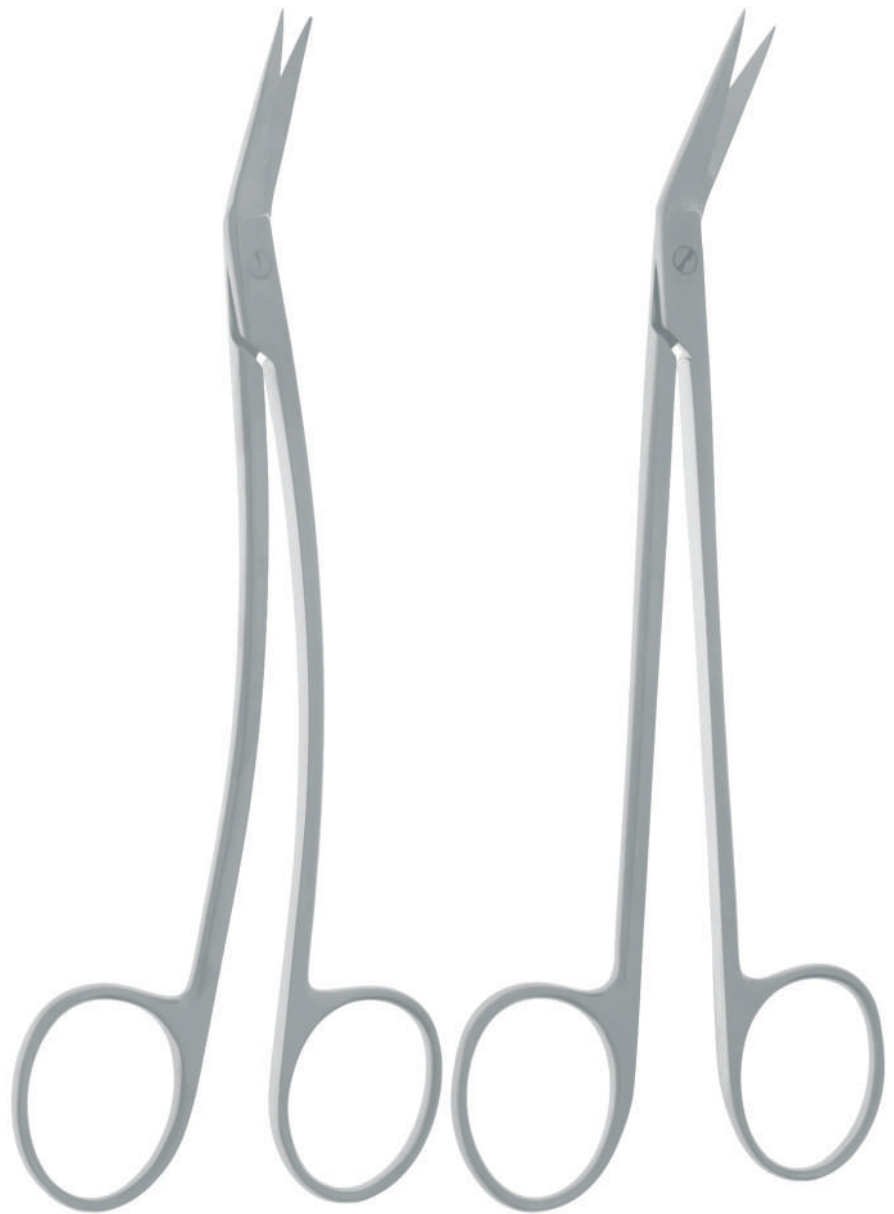

B258595
16 cm - 6 1/4"

B258596
16 cm - 6 1/4"

Ciseaux divers - Miscellaneous scissors - Tijeras diversas

DEAN



Dentelées
Saw edge
Dentadas

B258597
17 cm - 6 ³/₄"

QUINBY



Droit
Straight
Recta

Courbe
Curved
Curva

13 cm - 5"

B258598

B258599

B258599

B258598
13 cm - 5"

LANDOLT

CISEAUX À ÉNUCLÉATION - ENUCLEATION SCISSORS - TIJERAS PARA ENUCLÉACIÓN



Droit
Straight
Recta

B254012
12,5 cm - 5"



Demi-courbe
Half curved
Media curva

B254013
12,5 cm - 5"



Courbe
Curved
Curva

B254014
12,5 cm - 5"



Très courbe
Very curved
Muy curva

B254015
12,5 cm - 5"



JAMESON

REYNOLDS

	Droit Straight Recta	Courbe Curved Curva
15 cm - 6" 	B258499	B25850
18 cm - 7"	B258509	B25851

Courbe
Curved
Curva



B258495
15 cm - 6"



B258499
15 cm - 6"

B25850

TOENNIS

Droit
Straight
Recta

Courbe
Curved
Curva

18 cm - 7" 

B25852

B25853

Lames plates
Flat blades
Hojas planas

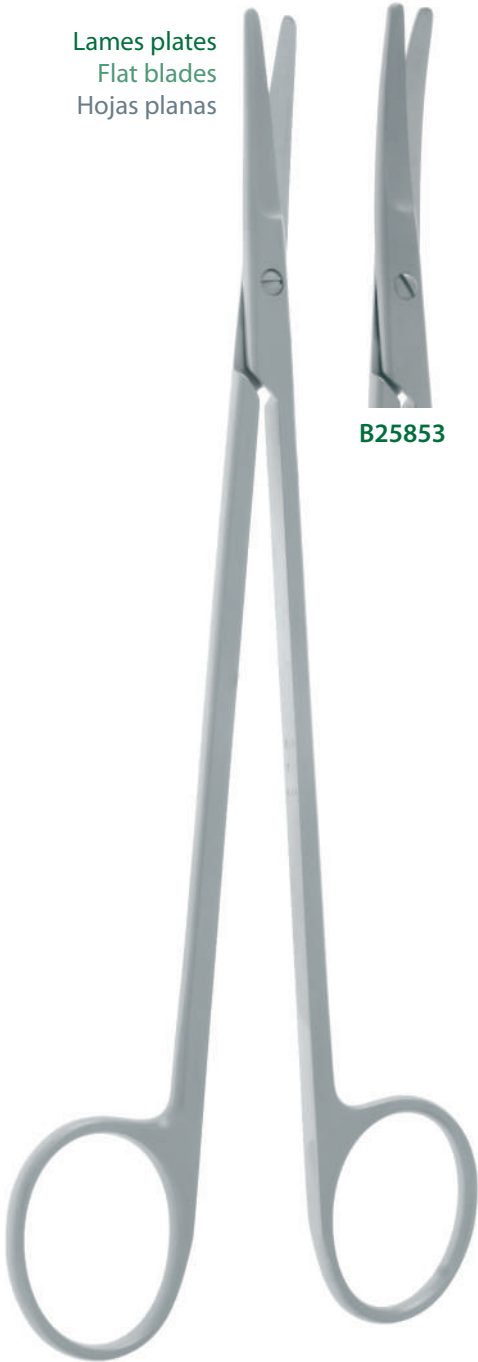

B25852
18 cm - 7"

B25853

TOENNIS-ADSON

TOENNIS-ADSON-FINO (DEBAKEY)

Lames rondes
Round blades
Hojas redondas



B258531
17,5 cm - 7"

B258532
17,5 cm - 7"



KELLY

Droit
Straight
Recta

Courbe
Curved
Curva

16 cm - 6 1/4" **B258468** **B258478**

18 cm - 7"  **B25847** **B25848**

Dentelées - Serrated - Serradas

16 cm - 6 1/4" **B258469** **B258479**

STRULLY

Courbe
Curved
Curva

Pour fistule
For fistula
Para fistula



B25848

B25847
18 cm - 7"



B258538
22,5 cm - 9"

B258537
22,5 cm - 9"

Ciseaux longs et fins - Long and fine scissors - Tijeras largas y finas

SANVENERO

Droit
Straight
Recta

Courbe
Curved
Curva

14,5 cm - 5³/₄"

B259730

B259731



BROPHY (SULLIVAN)

Droit
Straight
Recta

Courbe
Curved
Curva

13 cm - 5"

B259740

B259741



Droit
Straight
Recta

Courbe
Curved
Curva

14,5 cm - 5³/₄"

B259750

B259751



B259731



B259741



B259751

B259730
14,5 cm - 5³/₄"

B259740
13 cm - 5"

B259750
14,5 cm - 5³/₄"



KLINKENBERG

SATINSKY

SIEBOLD

Double courbure - Double curvature - Doble curvatura



B25920
23 cm - 9"

B25925
25 cm - 10"

B25930
24 cm - 9 1/2"

CRAFOORD

DUBOIS

Courbe
Curved
Curva

Droit
Straight
Recta

Courbe
Curved
Curva

23 cm - 9"

B259330

25 cm - 10"

B259340

30 cm - 11 ³/₄"

B25935



27 cm - 10 ¹/₂"

B25854

B25855



POUR LOBECTOMIE
FOR LOBECTOMY
PARA LOBECTOMÍA



B25935
30 cm - 11 ³/₄"

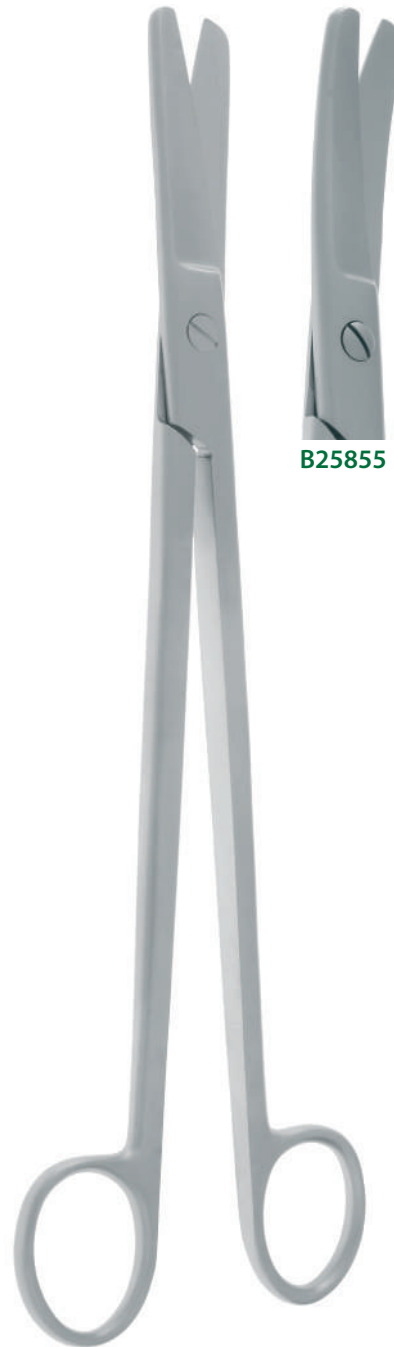

B25855

B25854
27 cm - 10 ¹/₂"

SIMS

WERTHEIM

	Droit Straight Recta	Courbe Curved Curva
20 cm - 8"	F05100	F05110
23 cm - 9" 	F05160	F05120

	Droit Straight Recta	Courbe Curved Curva
20 cm - 8"	F051001	F051101
23 cm - 9"	F051601	F051201

	Courbe Curved Curva
14,5 cm - 5 3/4"	F053014
20,5 cm - 8" 	F053019
23 cm - 9"	F053022

Mousse / Mousse
Blunt / Blunt
Roma / Roma



F05160
23 cm - 9"

Pointu / Mousse
Sharp / Blunt
Aguda / Roma



F051001 **F051101**

Droit
Straight
Recta

Courbe
Curved
Curva

20 cm - 8"	F051002	F051102
23 cm - 9"	F051602	F051202

Pointu / Pointu
Sharp / Sharp
Aguda / Aguda



F051002 **F051102**



F053019
20,5 cm - 8"

 Acier chromé
Chrome steel
Acero cromado

PRÉPARATION COLLEUR
GLUER PREPARATION
PREPARACIÓN ENCOLADOR

COIFFEUR
HAIRDRESSER
PELUQUERO



B25860
15 cm - 6"



B25865
25 cm - 10"





Acier chromé
Chrome steel
Acero cromado

COUTURIÈRE
DRESSMAKER
MODISTA

COUTURIÈRE BANCAL
WOBBLY DRESSMAKER
MODISTA COJO

LINGÈRE
LINGERE
LENCERA



B25870
13 cm - 5"



B25875
17 cm - 6 3/4"



B25880
20 cm - 8"

ROUENNAIS

Droit
Straight
Recta

12 cm - 4 ³/₄"

B25890

17 cm - 6 ³/₄"

B25900



B25900

17 cm - 6 ³/₄"

JESCO

	Noir Black Negra	Vert Green Verde	Bleu Blue Azúl	Rouge Red Roja	Jaune Yellow Amarillo
14,5 cm - 5 3/4"	B259040	B259041	B259042	B259043	B259044
18 cm - 7"	B25905	B259051	B259052	B259053	B259054



B259041
14,5 cm - 5 3/4"



B259051
18 cm - 7"





TC Insert

CATARACTE - CATARACT - CATARATA

KILNER (RAGNELL)

Courbe
Curved
Curva



B353015
12 cm - 4 3/4"

KELLY

CISEAUX POUR FISTULES
FISTULA SCISSORS
TIJERAS PARA FISTULAS

Droit
Straight
Recta



B353000
16 cm - 6 1/4"

Courbe
Curved
Curva



B353005

Fin - Pointu
Fine - Sharp
Fina - Aguda



B35001
11,5 cm - 4 1/2"

B35002



Microcut

B35001M



Microcut

B35002M



SupercutBlack

B35002SB

Standard
Standard
Estándar



B35001

Standard
Standard
Estándar

B35002

Ciseaux tungstène - Tungsten scissors - Tijeras de tungsteno



TC Insert

Droit
Straight
Recta

Courbe
Curved
Curva

Mousse / Mousse
Blunt / Blunt
Roma / Roma

Pointu / Mousse
Sharp / Blunt
Aguda / Roma

Pointu / Pointu
Sharp / Sharp
Aguda / Aguda

Mousse / Mousse
Blunt / Blunt
Roma / Roma

Pointu / Mousse
Sharp / Blunt
Aguda / Roma

Pointu / Pointu
Sharp / Sharp
Aguda / Aguda



B35003

B350031

B35005



B35004

B350041

B35006



B35003
14,5 cm - 5 ³/₄"



B350031



B35005



B35004
14,5 cm - 5 ³/₄"



B350041



B35006

LANDANGER

Ciseaux tungstène - Tungsten scissors - Tijeras de tungsteno



TC Insert

MAYO

Droit
Straight
Recta

Courbe
Curved
Curva

Standard
Standard
Estándar



Microcut

Standard
Standard
Estándar



Microcut



SupercutBlack

14 cm - 5 1/2" 

B35042

14 cm - 5 1/2" 

B35043

17 cm - 6 3/4"

B35044

B35044M

17 cm - 6 3/4"

B35045

B35045M

B35045SB

23 cm - 9"

B35046

23 cm - 9"

B35047

B35047SB



B35042
14 cm - 5 1/2"

Lames plates
Flat blades
Hojas planas



B35043
14 cm - 5 1/2"



* **Microcut** : 1 lame TC standard + 1 lame TC microdentée - 1 TC standard blade + 1 TC serrated blade - 1 hoja TC estándar + 1 hoja TC micro-serrada

* **SupercutBlack** : 1 lame TC microdentée + 1 lame TC rasoir + Nitrure de titane noir - 1 TC serrated blade + 1 TC razor blade + Black coating - 1 hoja TC micro-serrada + 1 hoja TC navaja + recubrimiento negro

LANDANGER

Ciseaux tungstène - Tungsten scissors - Tijeras de tungsteno



TC Insert

MAYO-LEXER

Standard
Standard
Estándar



B35007

LEXER-FINO

Droit - Straight - Recta

Standard
Standard
Estándar



B350090

MAYO-STILLE

Standard
Standard
Estándar



Microcut

15 cm - 6" 

B35010

17 cm - 6^{3/4}"

B35030

B35030M



Lames rondes
Round blades
Hojas redondas

B35007

16 cm - 6^{1/4}"

B350090

16 cm - 6^{1/4}"

B35010

15 cm - 6"

III - 60

* **Microcut** : 1 lame TC standard + 1 lame TC microdentée - 1 TC standard blade + 1 TC serrated blade - 1 hoja TC estándar + 1 hoja TC micro-serrada

* **SupercutBlack** : 1 lame TC microdentée + 1 lame TC rasoir + Nitrure de titane noir - 1 TC serrated blade + 1 TC razor blade + Black coating - 1 hoja TC micro-serrada + 1 hoja TC navaja + recubrimiento negro



1/1

LANDANGER

Ciseaux tungstène - Tungsten scissors - Tijeras de tungsteno



TC Insert

MAYO-LEXER

LEXER-FINO

MAYO-STILLE

Courbe - Curved - Curva

Standard
Standard
Estándar



Microcut



SupercutBlack

Standard
Standard
Estándar



SupercutBlack

Standard
Standard
Estándar



Microcut



B35008

B35008M

B35008SB



B350095

B350095SB

15 cm - 6" 

B35020

17 cm - 6^{3/4}"

B35040

B35040M



Lames rondes
Round blades
Hojas redondas

B35008

16 cm - 6^{1/4}"

B350095

16 cm - 6^{1/4}"

B35020

15 cm - 6"



* **Microcut** : 1 lame TC standard + 1 lame TC microdentée - 1 TC standard blade + 1 TC serrated blade - 1 hoja TC estandar + 1 hoja TC micro-serrada

* **SupercutBlack** : 1 lame TC microdentée + 1 lame TC rasoir + Nitrure de titane noir - 1 TC serrated blade + 1 TC rasor blade + Black coating - 1 hoja TC micro-serrada + 1 hoja TC navaja + recubrimiento negro



TC Insert

METZENBAUM

Droit - Straight - Recta

Courbe - Curved - Curva

Standard
Standard
Estándar



Microcut

Standard
Standard
Estándar



Microcut



SupercutBlack

Baby	B35104	B35104M	11,5 cm - 4 1/2"	B35106	B35106M	B35106SB	
	B35110		15 cm - 6"		B35120	B35120M	B35120SB
	B35130		18 cm - 7"	B35140	B35140M	B35140SB	
	B35150		20 cm - 8"	B35160	B35160M	B35160SB	
	B35172		23 cm - 9"	B35174	B35174M	B35174SB	
	B351750		25 cm - 10"	B351751			
	B351780		28 cm - 11"	B351781			
	B35250		30 cm - 11 3/4"	B35240			



B35110
15 cm - 6"



B35120
15 cm - 6"

III - 62

* **Microcut** : 1 lame TC standard + 1 lame TC microdentée - 1 TC standard blade + 1 TC serrated blade - 1 hoja TC estándar + 1 hoja TC micro-serrada



* **SupercutBlack** : 1 lame TC microdentée + 1 lame TC rasoir + Nitruro de titane noir - 1 TC serrated blade + 1 TC rasor blade + Black coating - 1 hoja TC micro-serrada + 1 hoja TC navaja + recubrimiento negro



TC Insert

METZENBAUM-FINO

Droit - Straight - Recta

Mousse / Mousse Blunt / Blunt Roma / Roma		Pointu / Pointu Sharp / Sharp Aguda / Aguda	
 B35048	15 cm - 6"	B350482 	
B35050	18 cm - 7"	B350502	
B35070	20 cm - 8"	B350702	
B35090	23 cm - 9"	B350902	
B351010	25 cm - 10"	-	
B351020	28 cm - 11"	-	



B35048
15 cm - 6"



B350482
15 cm - 6"



TC Insert

METZENBAUM-FINO

Courbe - Curved - Curva

Mousse / Mousse
Blunt / Blunt
Roma / Roma





Microcut



SupercutBlack

Pointu / Pointu
Sharp / Sharp
Aguda / Aguda

	B35049		B35049SB	15 cm - 6"	B350492 
	B35060	B35060M	B35060SB	18 cm - 7"	B350602
	B35080		B35080SB	20 cm - 8"	B350802
	B35100		B35100SB	23 cm - 9"	B351002
	B351011		B351011SB	25 cm - 10"	-
	B351021		B351021SB	28 cm - 11"	-



B35049
15 cm - 6"



B350492
15 cm - 6"

Ciseaux tungstène - Tungsten scissors - Tijeras de tungsteno



TC Insert

METZENBAUM-FINO

Double courbure
Double curvature
Doble curvatura

15 cm - 6"

B35228

18 cm - 7"

B35230



20 cm - 8"

B35232

23 cm - 9"

B35234

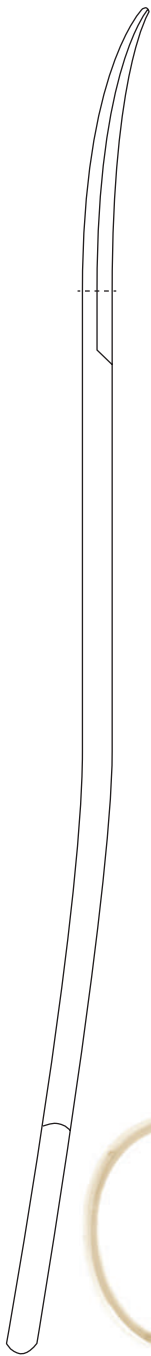

B35230
18 cm - 7"

TOENNIS-ADSON

Standard
Standard
Estándar



SupercutBlack

18 cm - 7"

B35260

B35260SB



Courbe
Curved
Curva

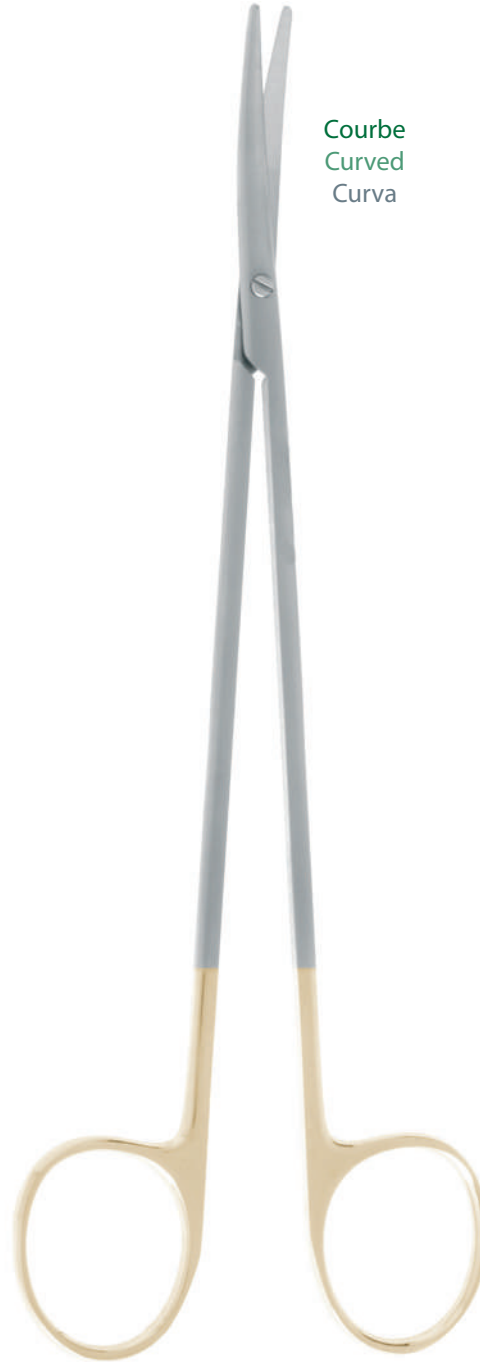

B35260
18 cm - 7"



* **Microcut** : 1 lame TC standard + 1 lame TC microdentée - 1 TC standard blade + 1 TC serrated blade - 1 hoja TC estándar + 1 hoja TC micro-serrada

* **SupercutBlack** : 1 lame TC microdentée + 1 lame TC rasoir + Nitrure de titane noir - 1 TC serrated blade + 1 TC rasor blade + Black coating - 1 hoja TC micro-serrada + 1 hoja TC navaja + recubrimiento negro



TC Insert

GOLDMANN-FOX

UNIVERSEL

LISTER

Droit
Straight
Recta

Courbe
Curved
Curva

CROIX ROUGE
RED CROSS
CRUZ ROJA

13 cm - 5"



B352580

B352581

Lames dentelées
Serrated blades
Hojas serradas

Lames dentelées
Serrated blades
Hojas serradas



B352580
13 cm - 5"

B352581



B35270
12 cm - 4^{3/4}"



B35280
18 cm - 7"

Ciseaux tungstène - Tungsten scissors - Tijeras de tungsteno



TC Insert

DUBOST

Droit
Straight
Recta

Courbe
Curved
Curva

23 cm - 9" 	B35180	B35190
26 cm - 10"	B35200	B35210

KLINKENBERG

Double courbure
Double curvature
Doble curvatura



B35180
23 cm - 9"

B35190

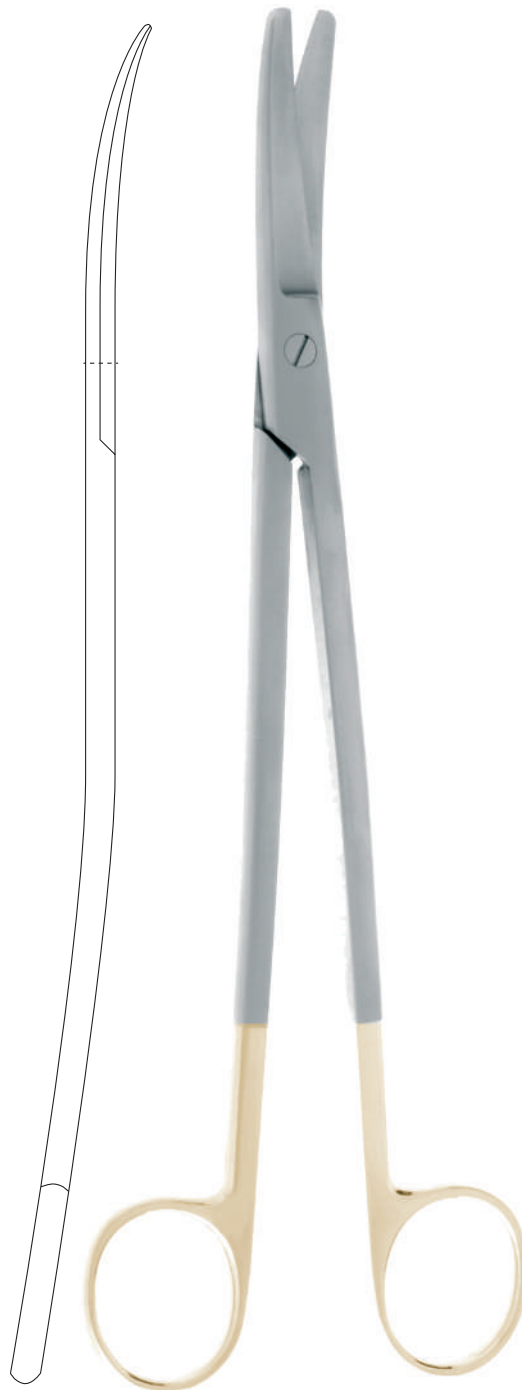

B35220
23 cm - 9"

III - Ciseaux
III - Scissors
III - Tijeras

Ciseaux tungstène - Tungsten scissors - Tijeras de tungsteno



TC Insert

SIMS

Droit Straight Recta	Courbe Curved Curva
----------------------------	---------------------------

20 cm - 8"	-	F051650
23 cm - 9"	F05170	F05175



CISEAUX À PARAMÈTRES PARAMETRIUM SCISSORS TIJERAS DE PARAMETRIO

Courbe Curved Curva	Très courbe Very curved Muy curva
---------------------------	-----------------------------------------



F05170
23 cm - 9"

F05175



F052000
23 cm - 9"

F052010



TC Insert

POTTS-SMITH

DEBAKEY

19 cm - 7 1/2" **B354025** **B354045** **B354060**

16 cm - 6 1/4" **B354125** **B354145** **B354160**



B354025

19 cm - 7 1/2"

B354125

16 cm - 6 1/4"



Ciseaux Prestige - Prestige scissors - Tijeras Prestige



Supercut



MAYO

MAYO-STILLE

MAYO-LEXER

	Droit Straight Recta	Courbe Curved Curva		Droit Straight Recta	Courbe Curved Curva
	B86215	B86230	15 cm - 6"		B86245
	B86220	B86235	17 cm - 6 3/4"	B86250	B86260
	B86225	B86240	23 cm - 9"		

Lames plates
Flat blades
Hojas planas

Lames rondes
Round blades
Hojas redondas

Droit
Straight
Recta

Courbe
Curved
Curva



B86230

B86215
15 cm - 6"



B86255

B86245
15 cm - 6"



B86210

B86205
16 cm - 6 1/4"

LANDANGER

Ciseaux Prestige - Prestige scissors - Tijeras Prestige



Supercut



BABY METZENBAUM

METZENBAUM

METZENBAUM-FINO

Droit
Straight
Recta

Courbe
Curved
Curva

Droit
Straight
Recta

Courbe
Curved
Curva

Droit
Straight
Recta

Courbe
Curved
Curva

11,5 cm - 4 1/2"

B86265

B86270



B86275

B86285

14,5 cm - 5 3/4"



B86305

B86310

B86280

B86290

18 cm - 7"

-

B86315

-

B86295

20 cm - 8"

-

-

-

B86300

23 cm - 9"

-

B86320



B86270

B86265

11,5 cm - 4 1/2"



B86285

B86275

14,5 cm - 5 3/4"



B86310

B86305

14,5 cm - 5 3/4"

III - Ciseaux
III - Scissors
III - Tijeras



Supercut



WAGNER

	Droit Straight Recta	Courbe Curved Curva		Droit Straight Recta	Courbe Curved Curva		Courbe Curved Curva
11,5 cm - 4 1/2"	B86325 	B86330	12 cm - 4 3/4"	B86335 	B86340	11 cm - 4 1/4"	B86345
						14 cm - 5 1/2"	B86350

CATARACTE
CATARACT
CATARATA

Pointu
Sharp
Aguda



B86325
11,5 cm - 4 1/2"

B86330

Pointu
Sharp
Aguda



B86335
12 cm - 4 3/4"

B86340

Mousse
Blunt
Roma



B86345
11 cm - 4 1/4"

LANDANGER

Ciseaux Prestige - Prestige scissors - Tijeras Prestige



Supercut



STEVENS

Droit
Straight
Recta

Courbe
Curved
Curva

11,5 cm - 4 1/2"

B86355



B86360

REYNOLDS

Droit
Straight
Recta

Courbe
Curved
Curva

13 cm - 5"

-

B86365

15 cm - 6"

B86370



B86375

JAMESON

Courbe
Curved
Curva

15 cm - 6"

B86380



18 cm - 7"

B86385

Lames mousses étroites - Narrow blunt blades - Hojas romas estrechas



B86360

B86355
11,5 cm - 4 1/2"

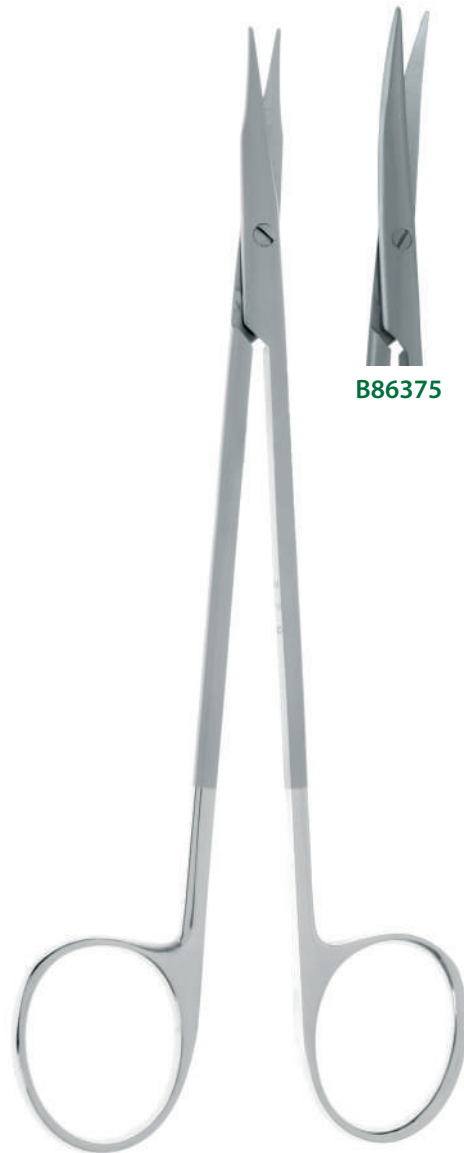

B86375

B86370
15 cm - 6"



B86380
15 cm - 6"

III - Ciseaux
III - Scissors
III - Tijeras



Supercut

Prestige

POTTS-SMITH

	25°	45°	60°
19 cm - 7 1/2"	B86390	B86395	B86400



Pointu
Sharp
Aguda

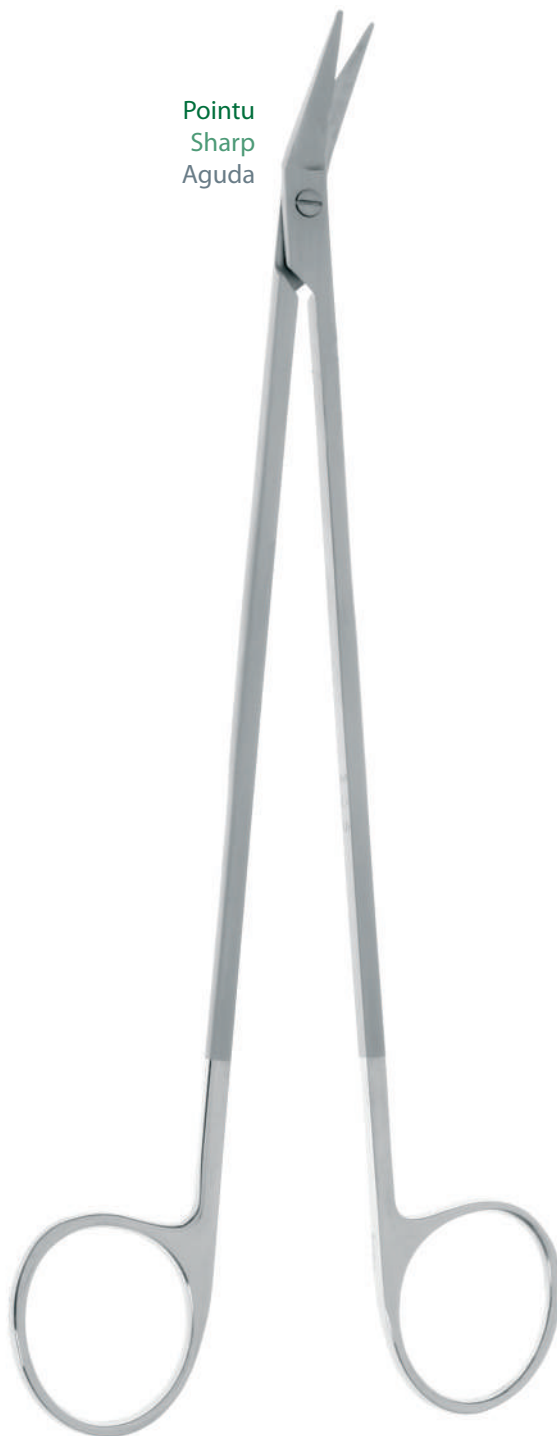

B86390
19 cm - 7 1/2"



25°



45°



60°



MERVEILLEUX

2 lames standards - Courbe
2 standard blades - Curved
2 hojas estándares - Curva

Mousse
Blunt
Roma

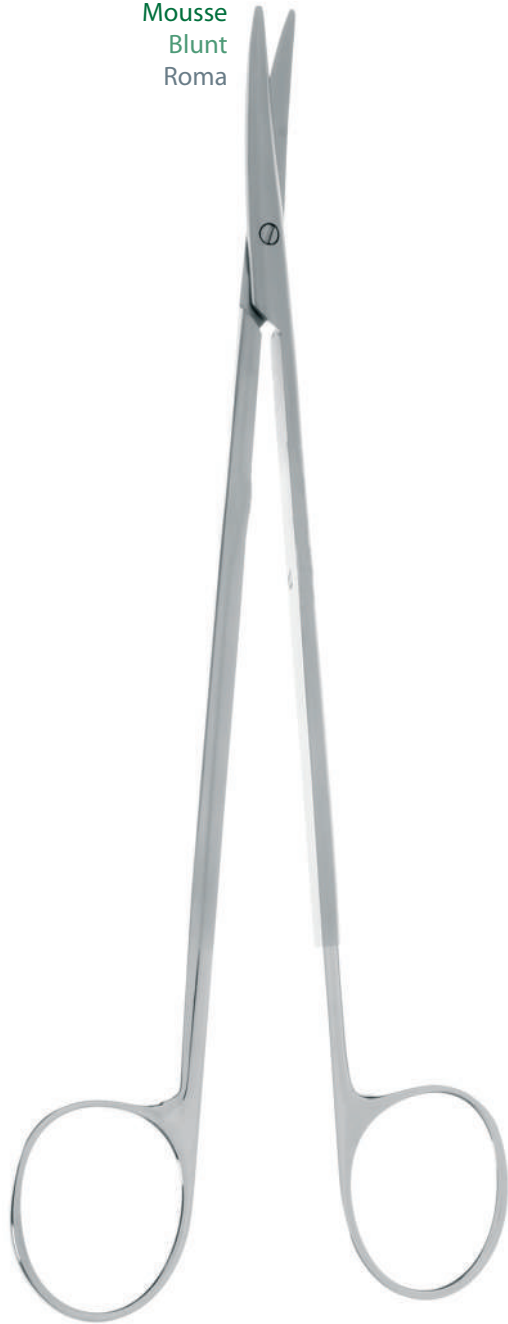

B864020
17,5 cm - 6 ³/₄"

Pointu
Sharp
Aguda

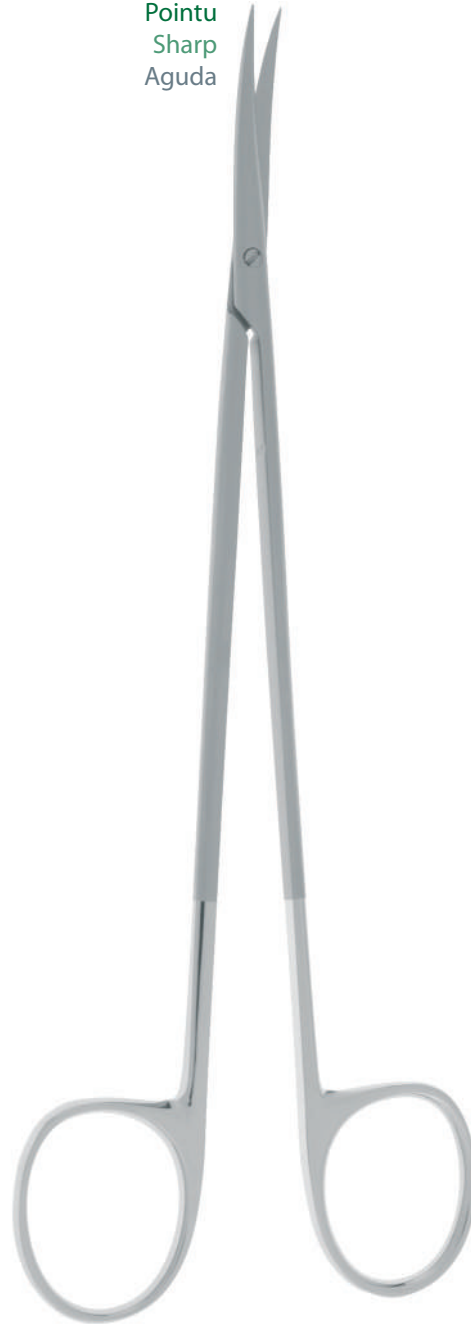

B864025
17,5 cm - 6 ³/₄"

Ciseaux Prestige - Prestige scissors - Tijeras Prestige



Supercut



SIMS

JOSEPH

Droit
Straight
Recta

Courbe
Curved
Curva

20 cm - 8" 	B86410	B86415
23 cm - 9"	-	B86420



B86415



B86410
20 cm - 8"



B86425
15 cm - 5 3/4"



Ciseaux Prestige - Prestige scissors - Tijeras Prestige



Supercut

Prestige

KAYE

GORNEY

Droit
Straight
Recta

Courbe
Curved
Curva

20,5 cm - 8"



B864400

B864405

Courbe
Curved
Curva

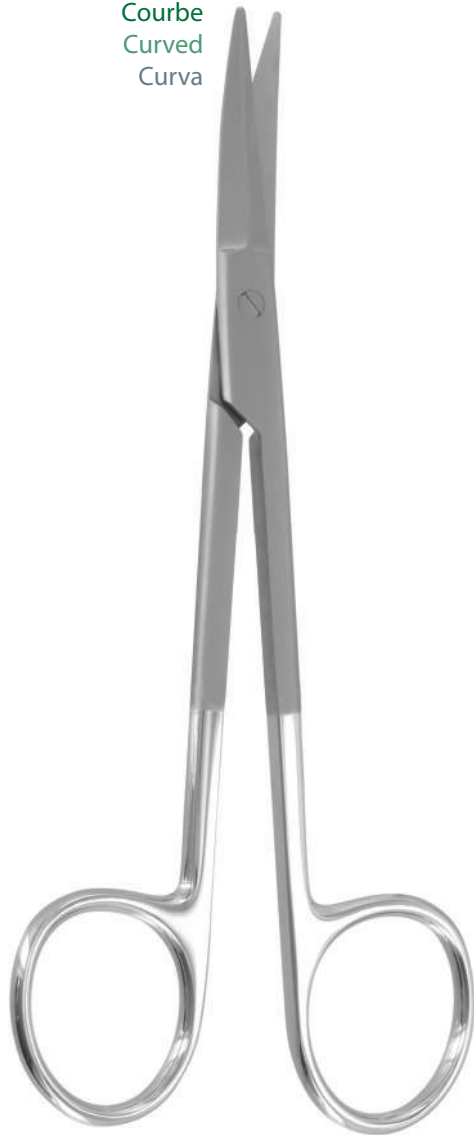

B864300
15 cm - 6 1/2"



B864405



B864400
20,5 cm - 8"





Supercut

Prestige

FOMON

CISEAUX NASAUX
NASAL SCISSORS
TIJERAS NAsALES



B864500
13,5 cm - 5"



B864505
13,5 cm - 5"

Ciseaux Prestige - Prestige scissors - Tijeras Prestige



Supercut

Prestige

COTTLE

HEYMANN

CISEAUX NASAUX
NASAL SCISSORS
TIJERAS NASALES



B864510
16,5 cm - 6 1/4"



B864515
18 cm - 7"

III - Ciseaux
III - Scissors
III - Tijeras

Ciseaux pour le cordon ombilical - Scissors for umbilical cord - Tijeras para el cordón umbilical

BUSCH (VEZIEN)

- 13 cm - 5" B257470
- 16 cm - 6 1/4" B257471
- 18 cm - 7" B257500 

USA

SCHUMACHER



B257500
18 cm - 7"



F05130
10,5 cm - 4"



F051310
16 cm - 6 1/4"

III - Ciseaux
III - Scissors
III - Tijeras

DELESTRE

14 cm - 5 1/2" **B257540** 

18 cm - 7" **B257550**

BRAUN-STADLER

14 cm - 5 1/2" **B25760** 

22 cm - 8 3/4" **B257602**



B257540
14 cm - 5 1/2"



B25760
14 cm - 5 1/2"

Ciseaux à épisiotomie - Episiotomy scissors - Tijeras episiotomía

WALDMANN



TC Insert

Inox
Stainless steel
Acero inoxidable

19 cm - 7 1/2"

F05180

F051850



Prestige

III - Ciseaux
III - Scissors
III - Tijeras

Lame dentelée
Serrated blade
Hoja serrada



F05180
19 cm - 7 1/2"



Supercut



B86405
18 cm - 7"

JOSEPH

Droit
Straight
Recta

Courbe
Curved
Curva

FOMON

HALLE

14 cm - 5 1/2"



I19010

I19020

CISEAUX NASAUX
NASAL SCISSORS
TIJERAS NASALES



I19020

I19010
14 cm - 5 1/2"



I190070
13,5 cm - 5 1/4"

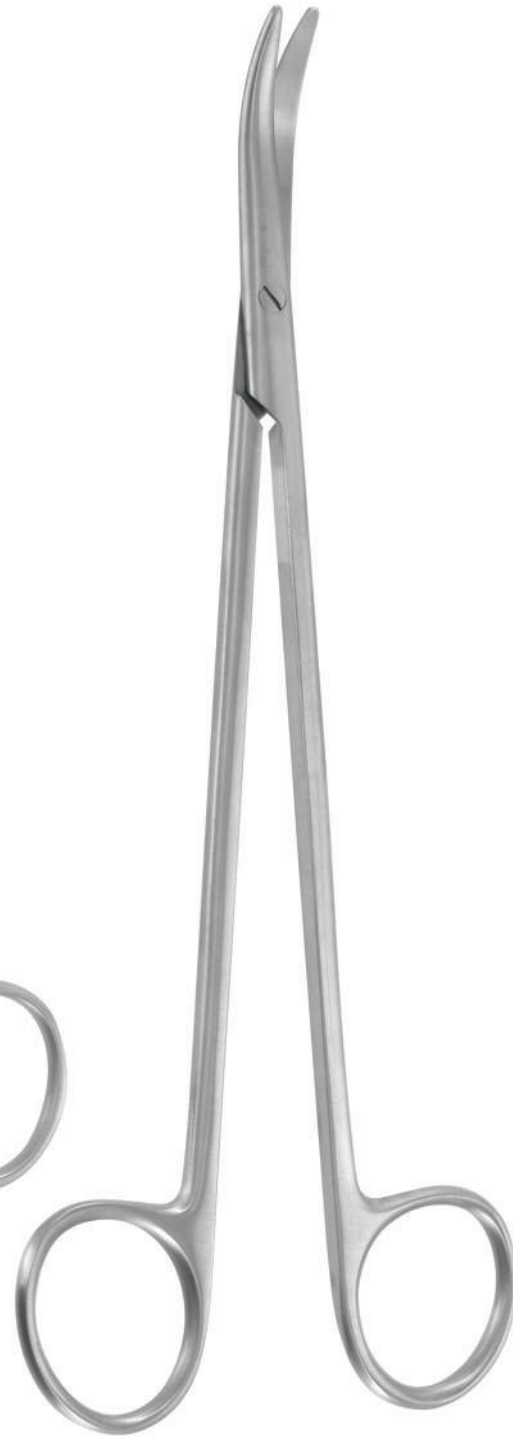

I190075
19 cm - 7 1/2"

III - Ciseaux
III - Scissors
III - Tijeras

FOMON

Standard
Standard
Estándar

 **I190080**



B355000

Lame ronde
Round blade
Lamas redondas



I190080
13 cm - 5"

Lame plate
Flat blade
Lamas planas



I190085
13,5 cm - 5 1/4"

COTTLE

Standard
Standard
Estándar

 **I190090**



B355010

Lame ronde
Round blade
Lamas redondas



I190090
16 cm - 6 1/4"

HEYMANN

Lame ronde
Round blade
Lamas redondas



I190050
18 cm - 7"

CISEAUX NASAUX
NASAL SCISSORS
TIJERAS NASALES

Lame plate
Flat blade
Lamas planas



I190060
18 cm - 7"

BRUNS

CISEAUX BRUNS À PANSEMENTS ET BANDAGES PLÂTRÉS
BRUNS CLOTHING SCISSORS, PLASTER SCISSORS
BRUNS TIJERAS PARA CURAS Y VENDAJES ESCAYOLADOS

Lame dentelée
Serrated blade
Hoja serrada

Lame lisse
Smooth blade
Hoja lisa

23,5 cm - 9 1/4"

J76140

J761410

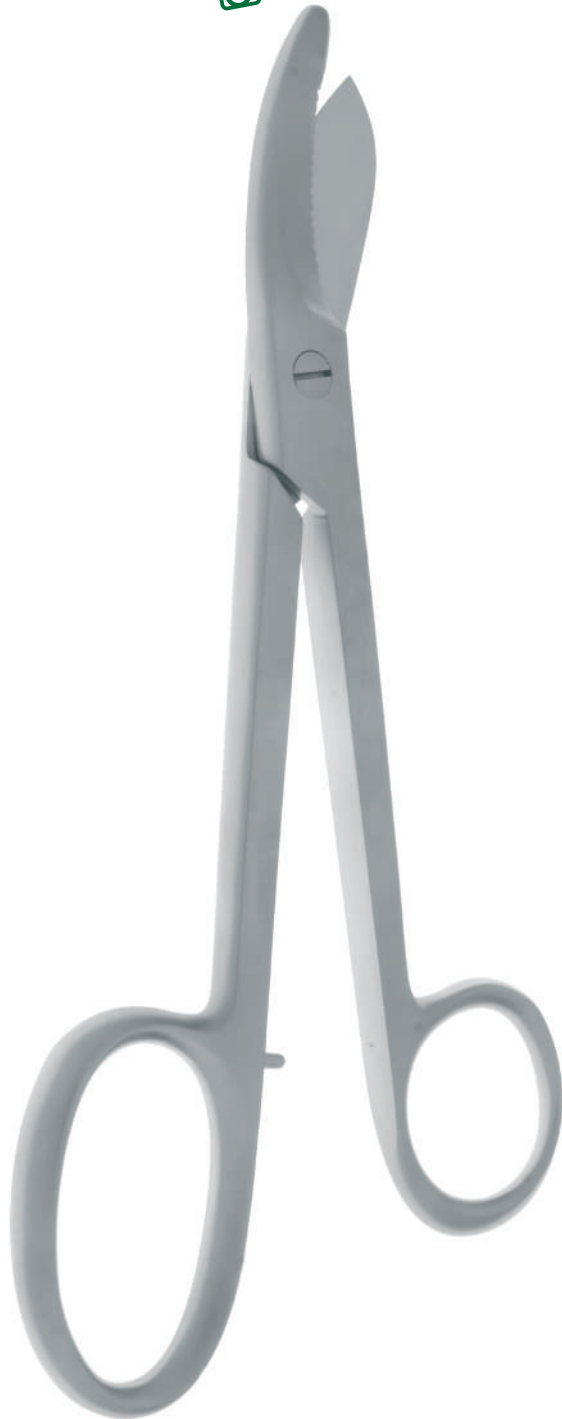

J76140
23,5 cm - 9 1/4"

LANGE



B257618
18 cm - 7"

CISEAUX À DÉCAPSULER
SCISSORS TO UNCAP
TIJERAS PARA DECAPSULAR

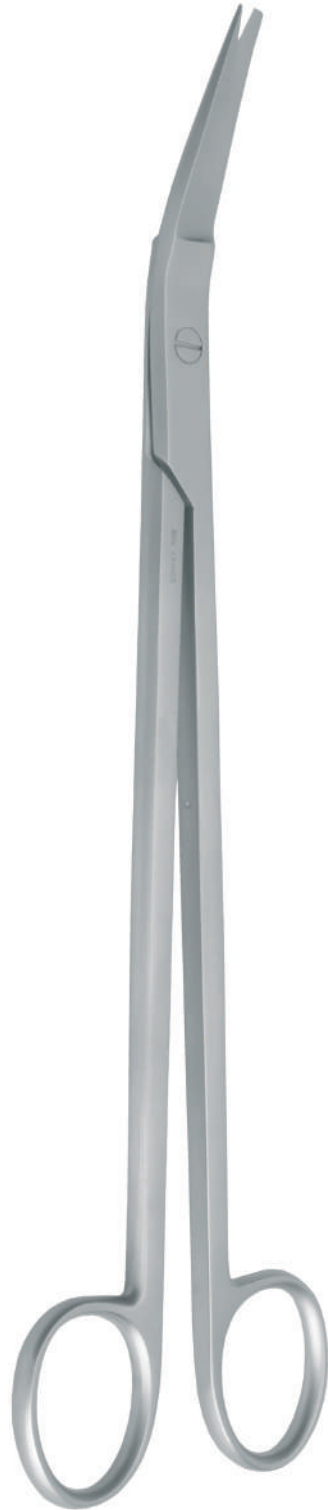

J72700
25 cm - 10"

CISEAUX À MÉNISQUE
MENISCUS SCISSORS
TIJERAS PARA MENISCO

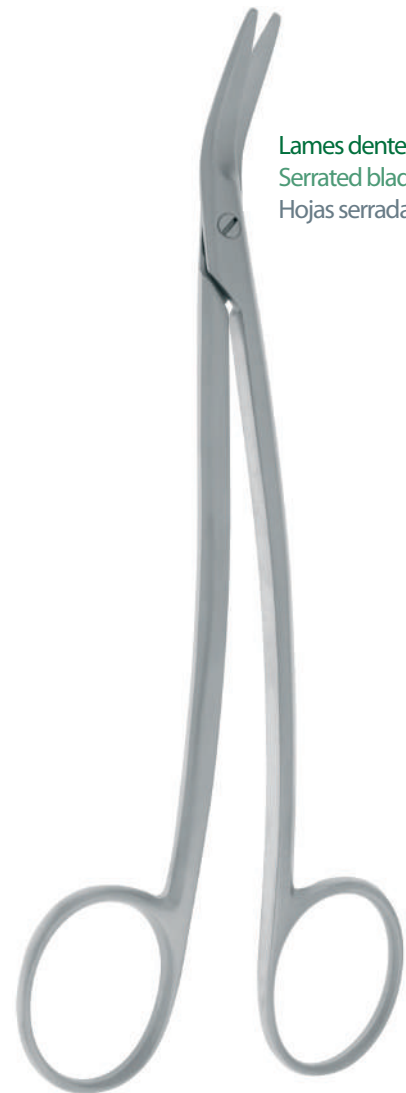

Lames dentelées
Serrated blades
Hojas serradas

J80170
18 cm - 7"

SMITH

CISEAUX ENTEROTOME
ENTEROTOME SCISSORS
TIJERAS ENTEROTOMO



J14145
21 cm - 8 1/4"



J14146
21 cm - 8 1/4"



B259100
17,5 cm - 7"

III - Ciseaux
III - Scissors
III - Tijeras

Ciseaux à ongles - Nails scissors - Tijeras para uñas

Droit
Straight
Recta

 **A85090** 11 cm - 4 1/4"



Courbe
Curved
Curva

A85100



CISEAUX À FENDRE LES ONGLES
NAIL SPLITTING SCISSORS
TIJERAS PARA HENDER LAS UÑAS

13 cm - 5" **A851113** 

15 cm - 6" **A851115**



A851113
13 cm - 5"

Droit
Straight
Recta

 **A851010** 10,5 cm - 4 1/4"



Courbe
Curved
Curva

A851015



Pinces hémostatiques - Haemostatic forceps - Pinzas hemostáticas

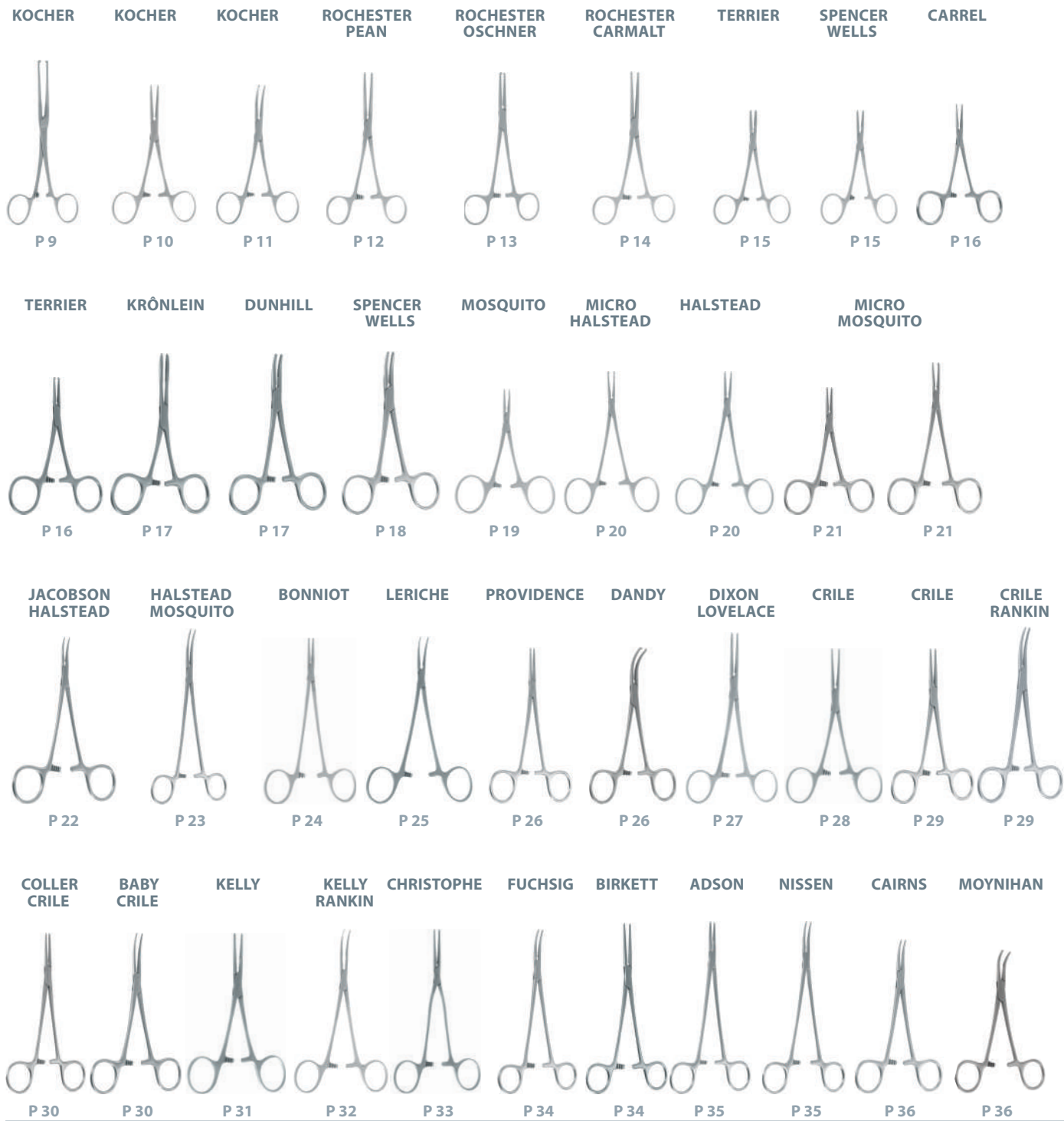

Pinces hémostatiques longues - Long haemostatic forceps - Pinzas hemostáticas largas

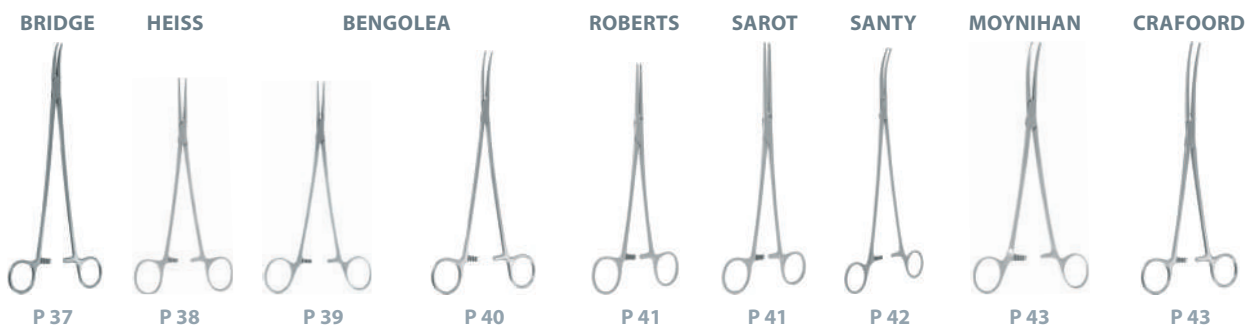

Pinces hémostatiques spéciales - Special haemostatic forceps - Pinzas hemostáticas especiales

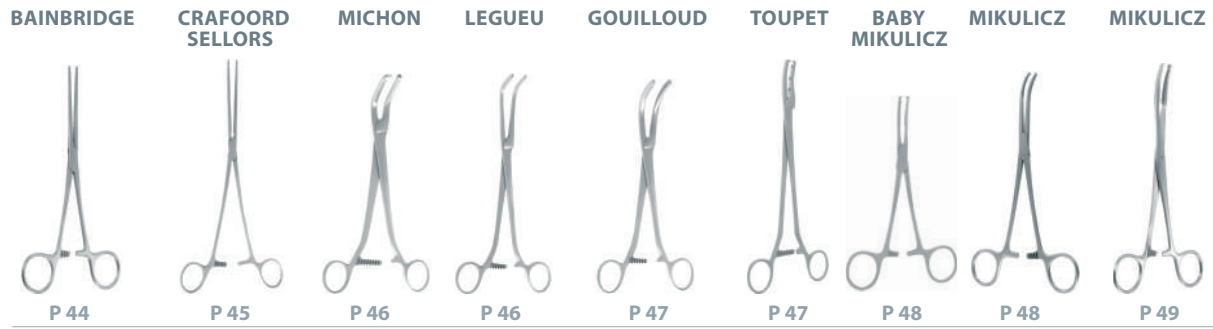

Pinces passe-fils, dissecteurs - Ligature forceps, dissectors - Discadores

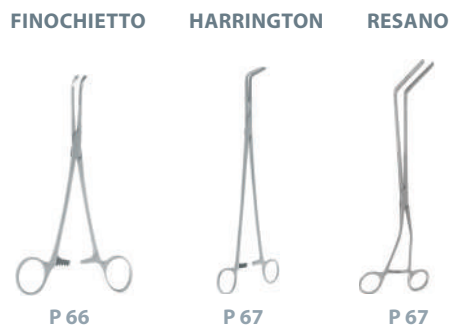
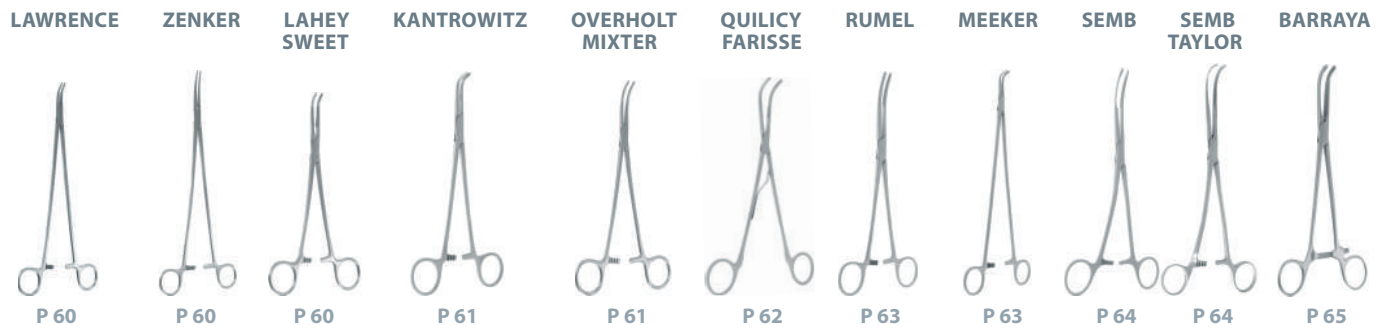
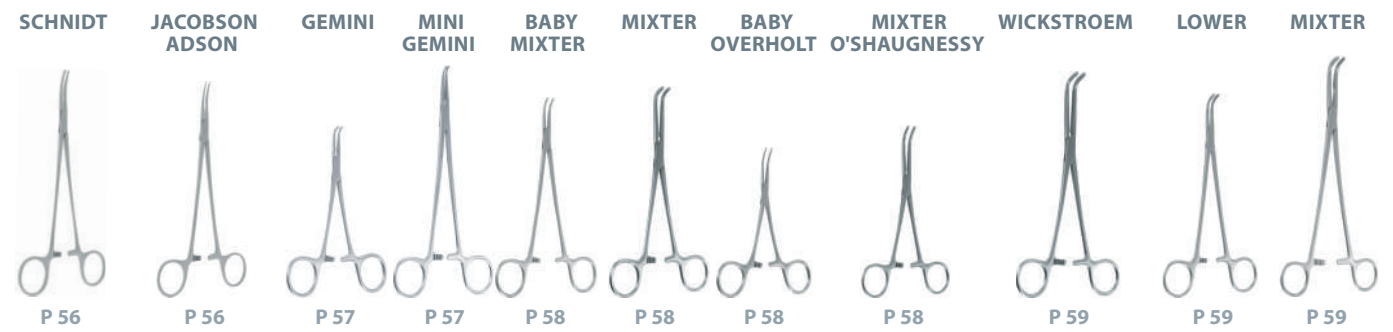
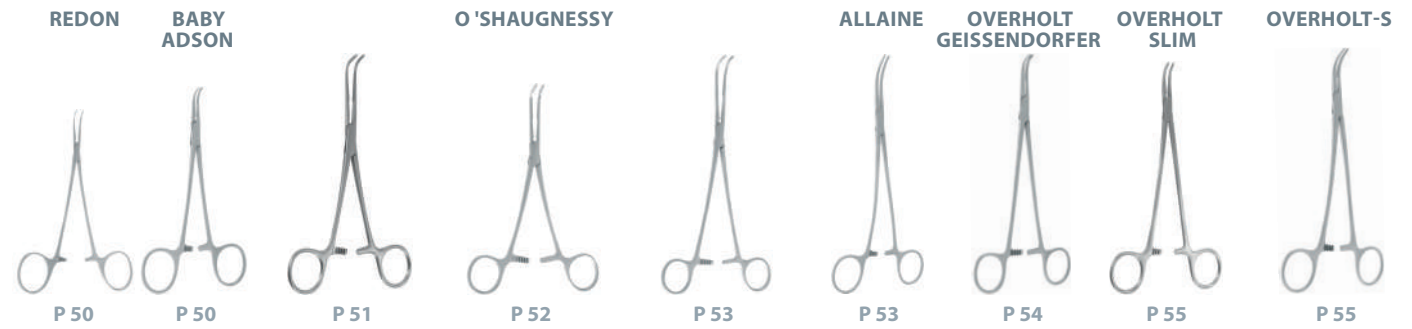

Pinces clamps intestinales et stomacales - Intestinal and stomach clamp forceps - Pinzas clamps intestinales y estomacales

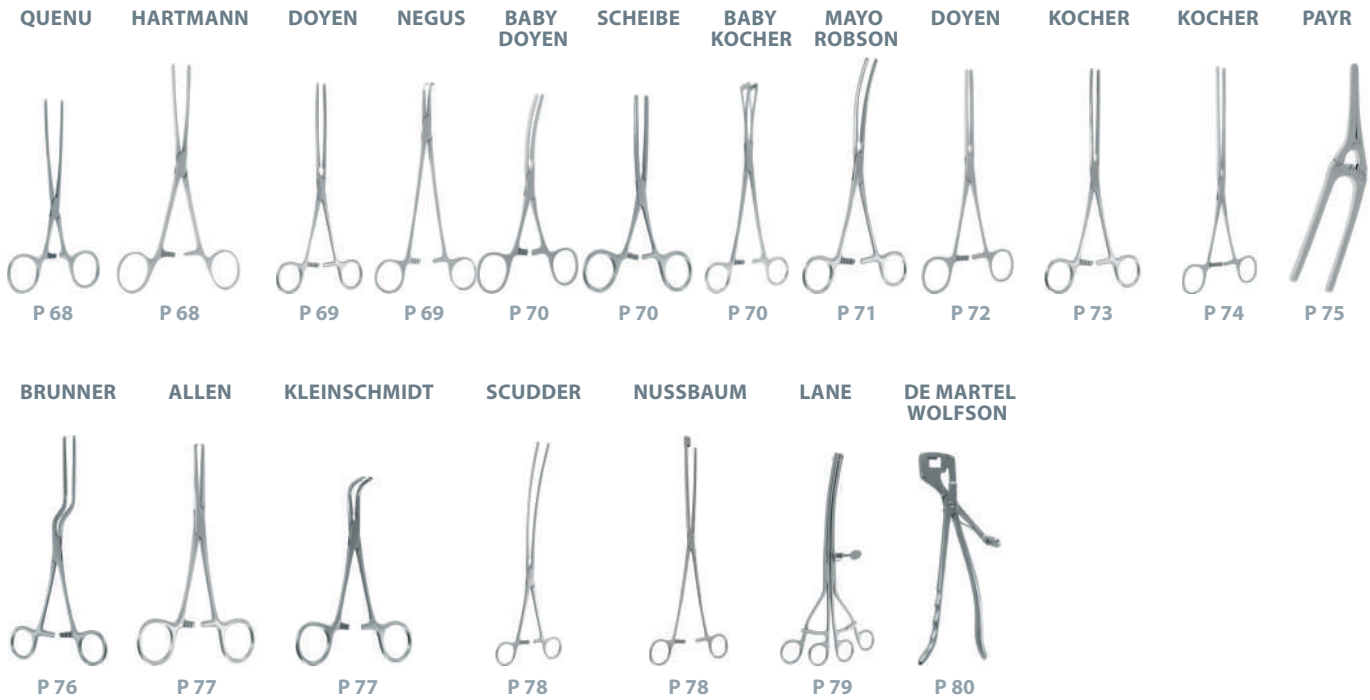

Pinces à préhension - Grasping forceps - Pinzas a prensión

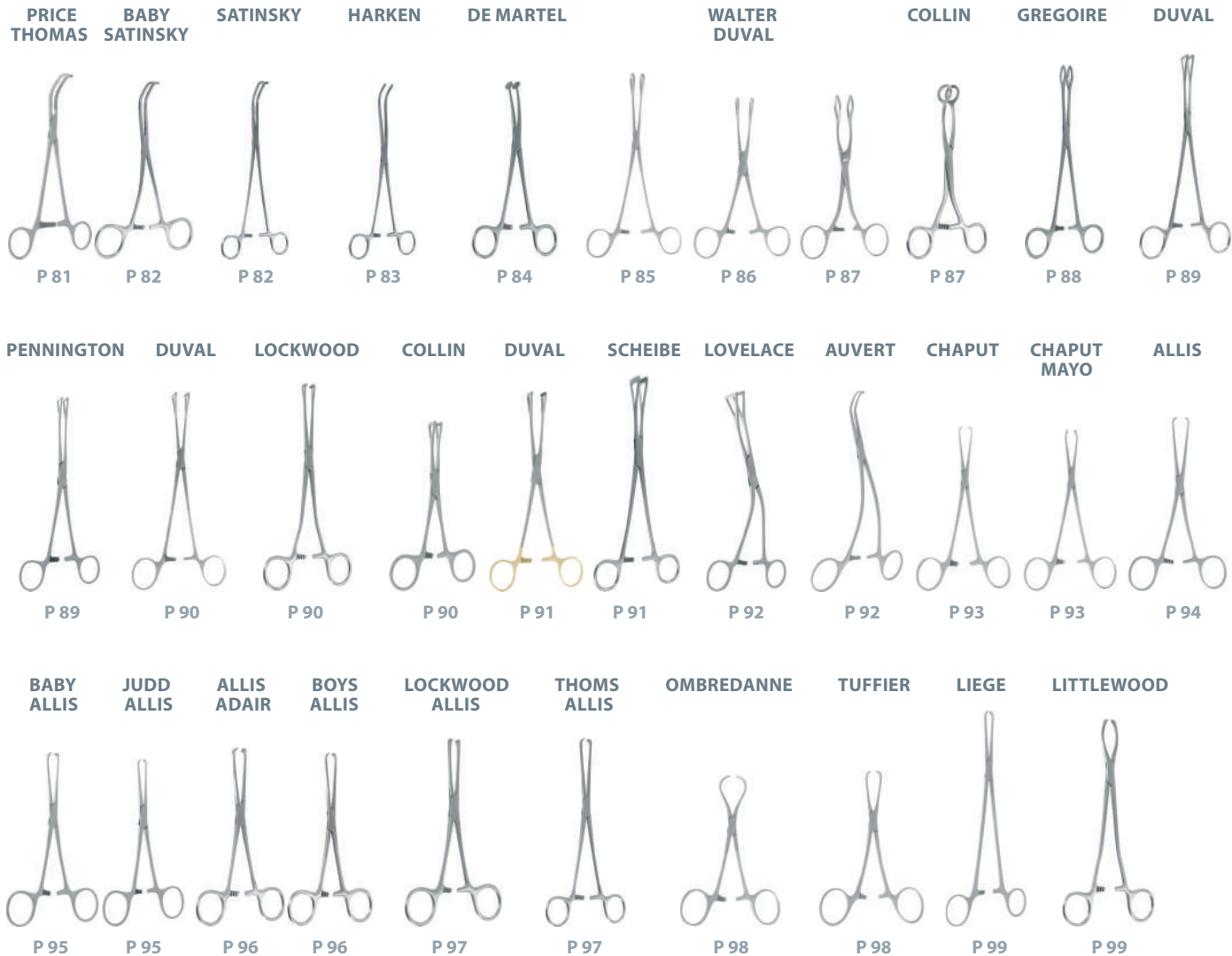

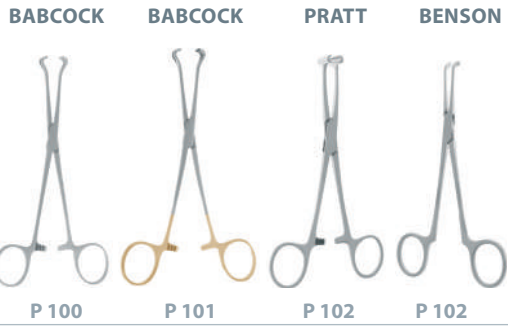

Pinces à champs - Towel forceps - Pinzas de compo

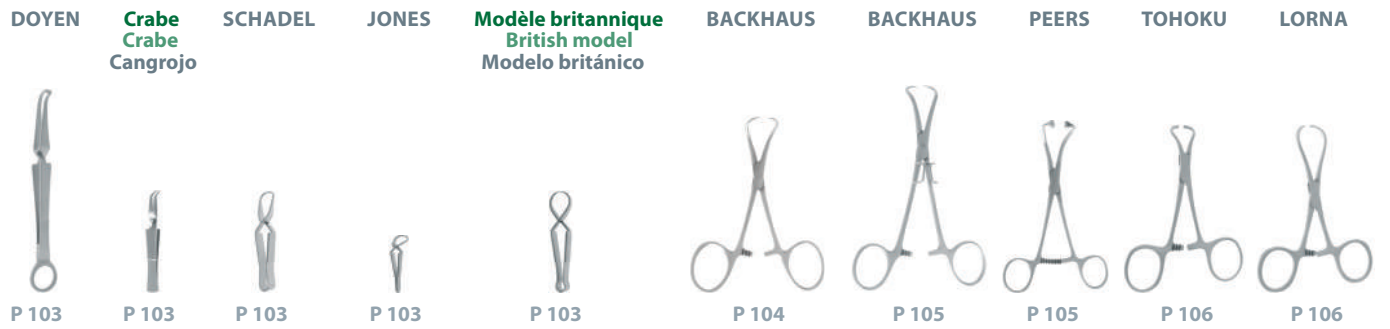

ROEDER



Pinces diverses - Miscellaneous forceps - Pinzas diversas

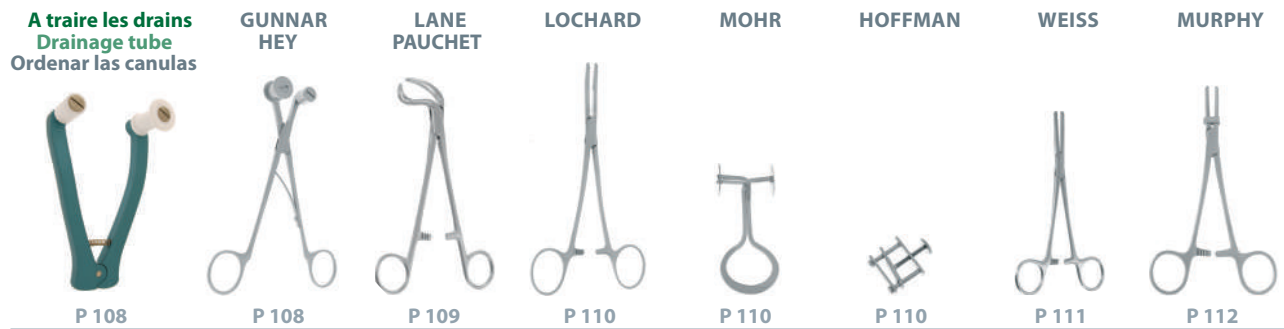

Pinces hémostatiques Prestige - Prestige Haemostatic forceps - Pinzas hemostáticas Prestige

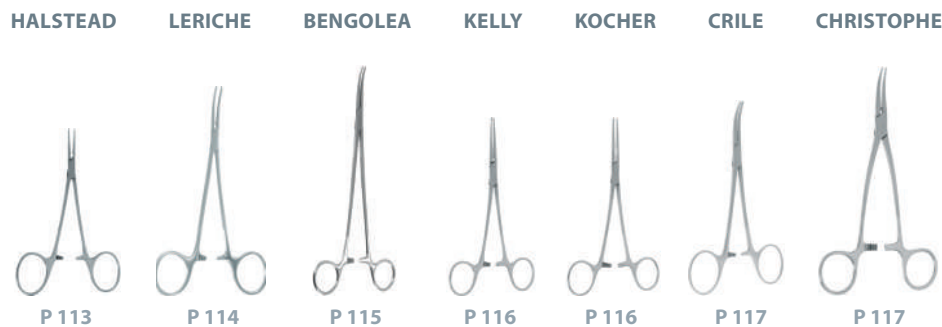

Pinces à pansements - Bandage forceps - Pinzas para vendajes

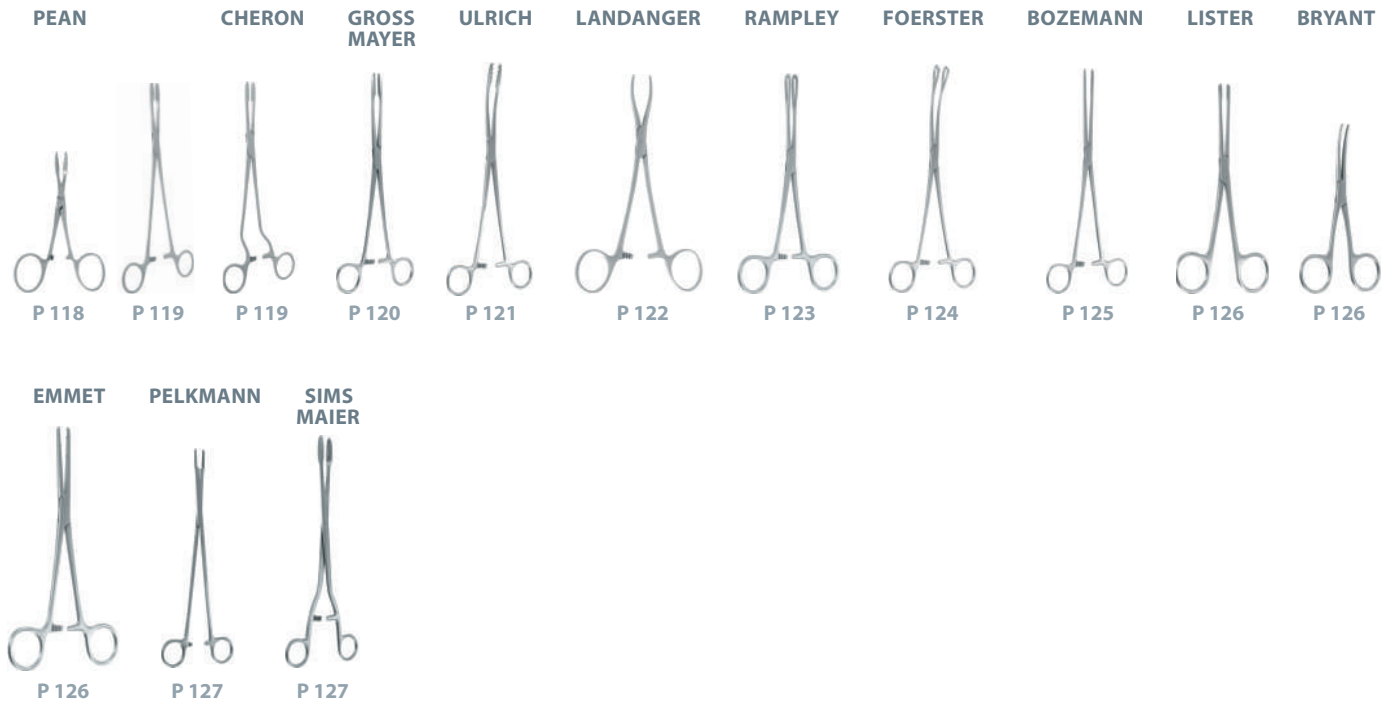

Pinces à échardes - Splinters forceps - Pinzas para astillas

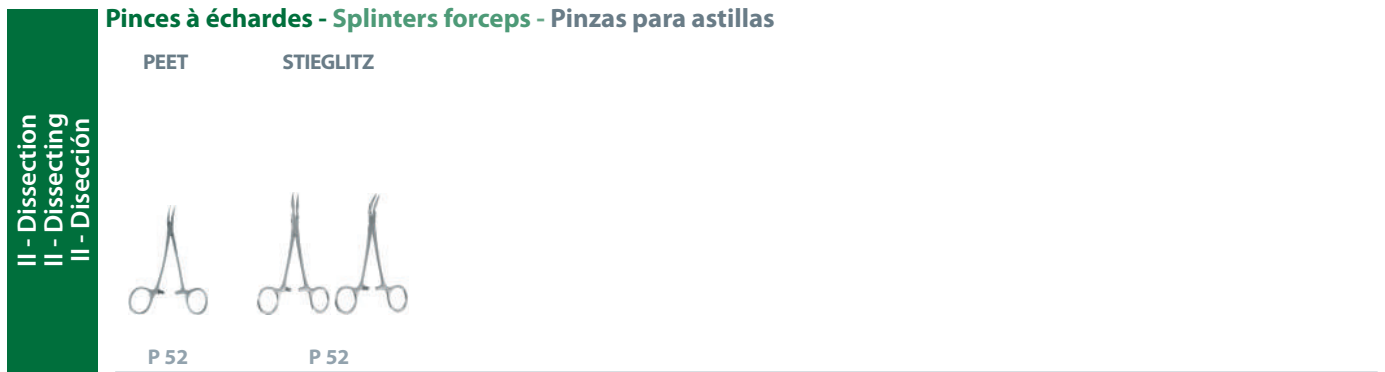

Pinces utérines - Uterines forceps - Pinzas uterinas

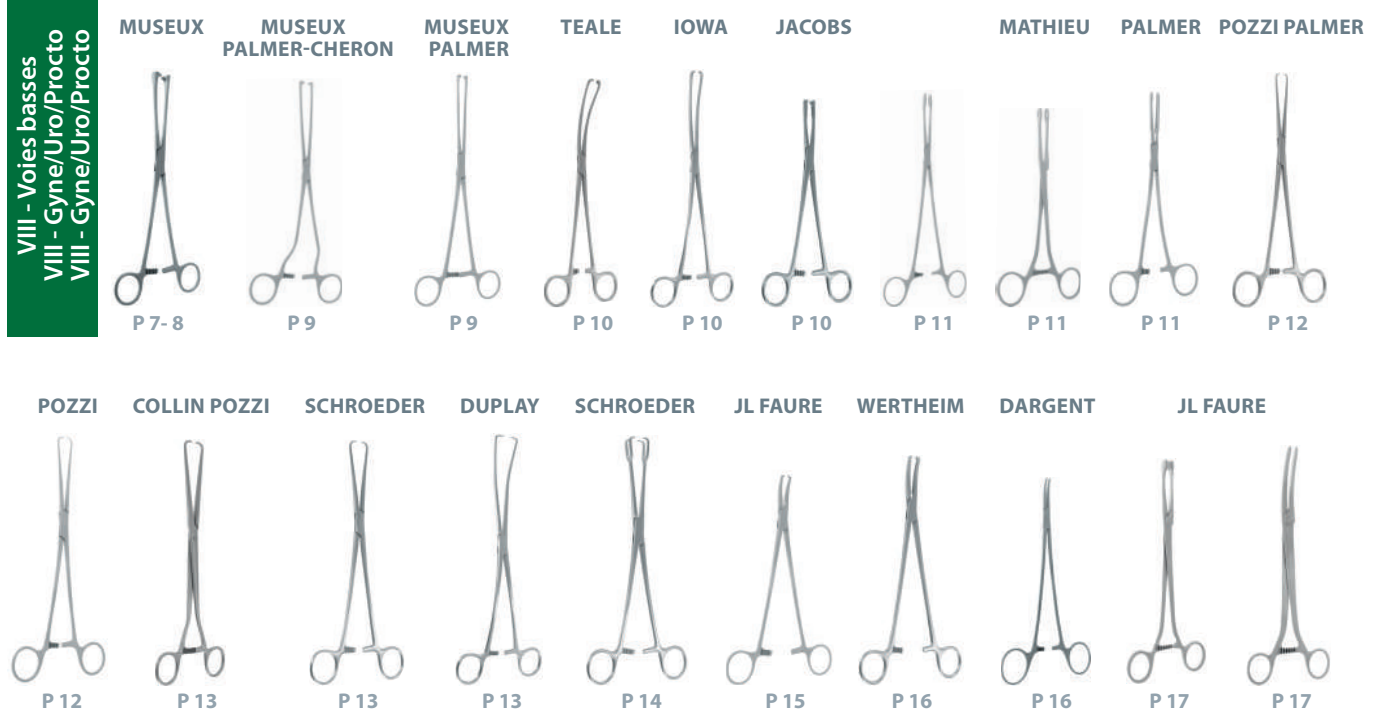

IV - Pinces
IV - Forceps
IV - Pinzas

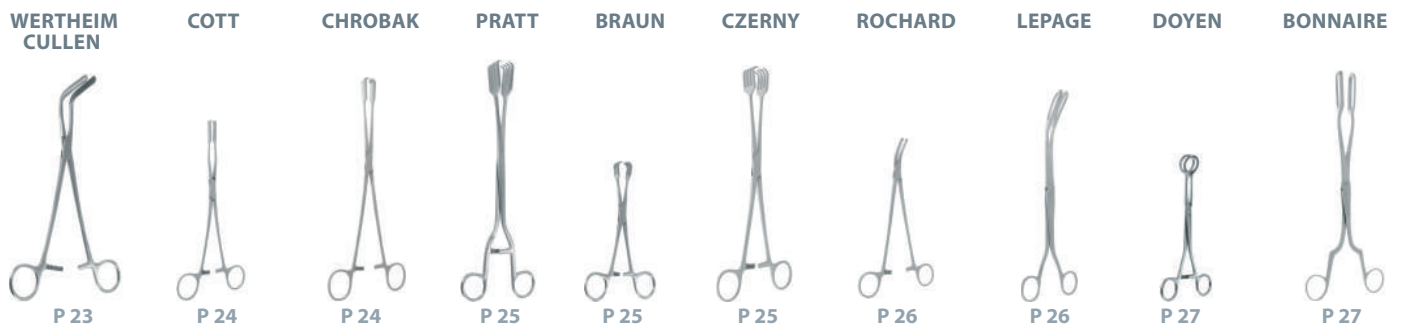
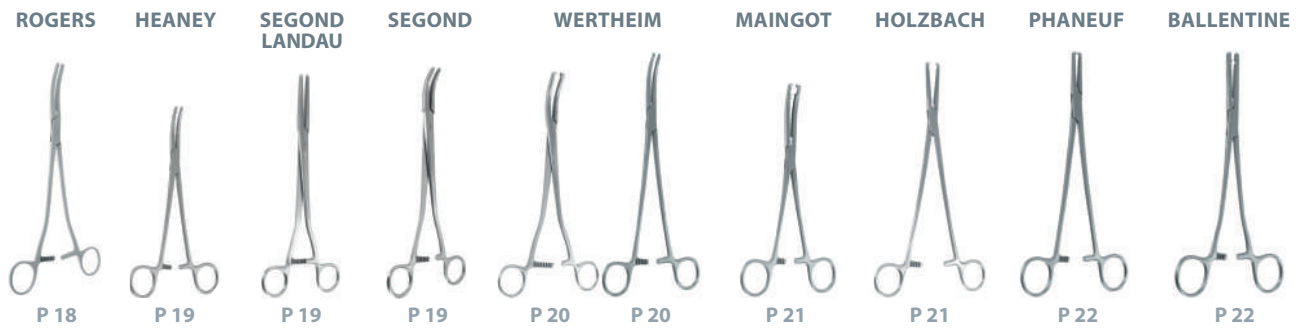

Pince hystérolable - Uterine elevating forceps - Pinzas para coger el útero

VIII - Voies basses
VIII - Gyne/Uro/Procto
VIII - Gyne/Uro/Procto

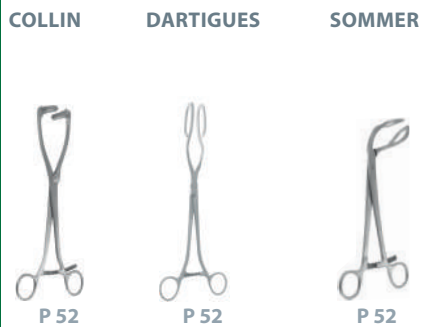

Instruments pour prostate - Instruments for prostate - Instrumentos para prostate

VIII - Voies basses
VIII - Gyne/Uro/Procto
VIII - Gyne/Uro/Procto

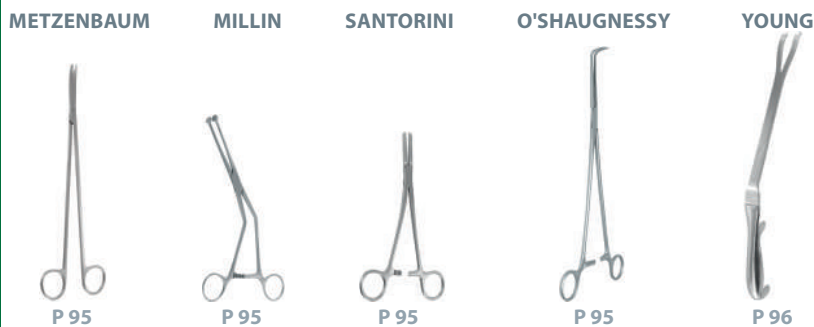

Pinces pour calculs rénaux - Forceps for kidney stones - Pinzas para cálculos renales

IX - Voies biliaires
IX- Bile ducts
IX - Vías biliares



Pinces pour calculs biliaires - Forceps gales stones - Pinzas para cálculos biliaires

IX - Voies biliaires
IX- Bile ducts
IX - Vías biliares

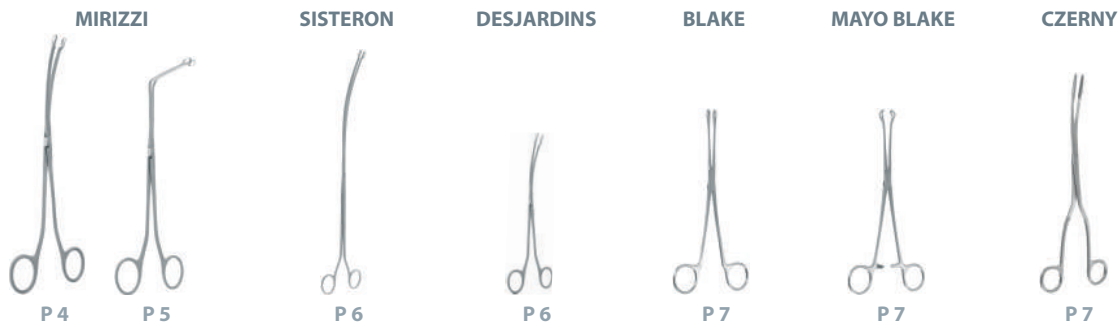

Instruments pour pédicules rénaux - Instruments for kidney pedicle - Pinzas para pedunculos renales

IX - Voies biliaires
IX- Bile ducts
IX - Vías biliares



Instruments pour voies biliaires - Instruments for bile ducts - Instrumentos para vías biliares

IX - Voies biliaires
IX- Bile ducts
IX - Vías biliares



O.R.L. pinces à préhension - E.N.T. grasping forceps - O.R.L. pinzas a prensión

XII - O.R.L.
XII - E.N.T.
XII - O.R.L.

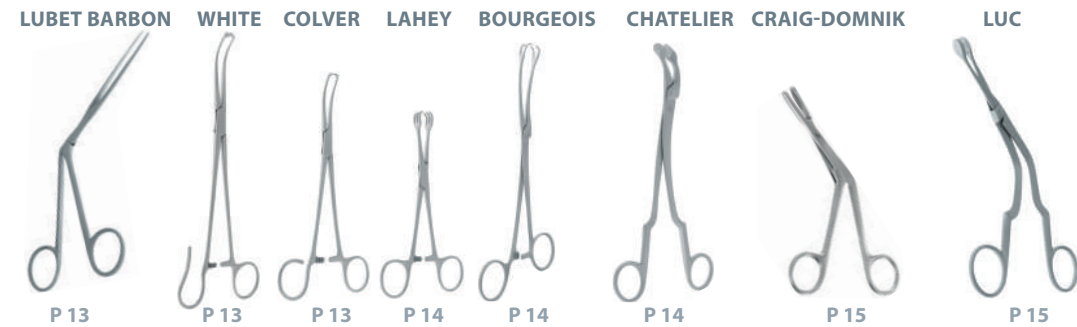

IV - Pinces
IV - Forceps
IV - Pinzas

Chirurgie des tendons - Surgery for tendons - Cirugía para tendones

XIII - Osseux
XIII - Bone surgery
Cirugía osea

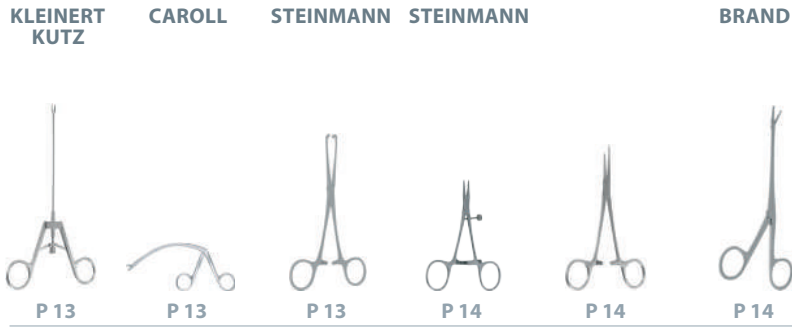

Daviers - Bone holding forceps - Pinzas para huesos

XIII - Osseux
XIII - Bone surgery
Cirugía osea



Pour épaule - For shoulder - Para hombro



Pour ménisque - For meniscus - Para menisco



Instrumentation de service - Instrumentation for services - Instrumentación de servicio

XV - Divers
XV - Miscellaneous
XV - Diversos

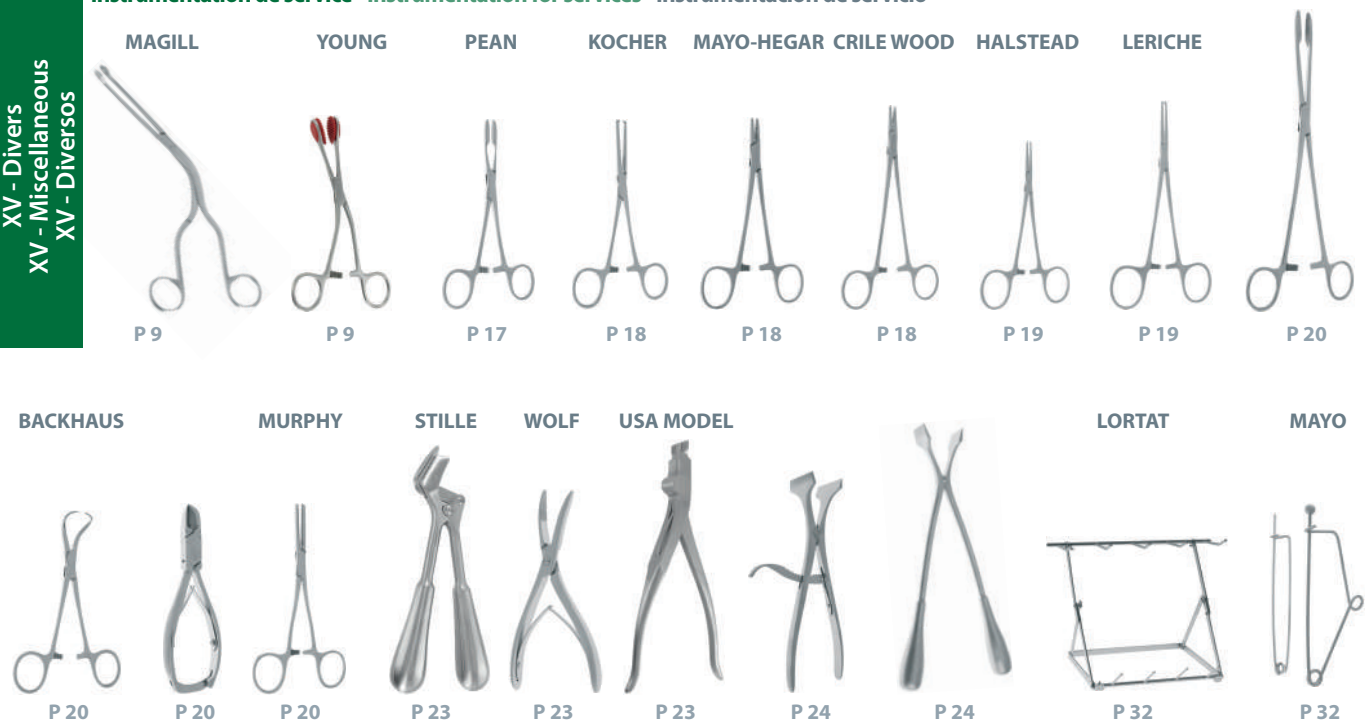

KOCHER

A griffes
With teeth
Con dientes

13 cm - 5"

B50070

15 cm - 6"

B50075



18 cm - 7"

B50085



A doigt
Collin's lock
Desmontable

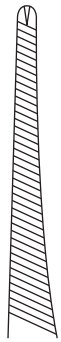

B50070
13 cm - 5"

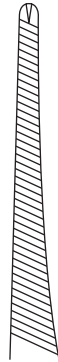

B50075
15 cm - 6"

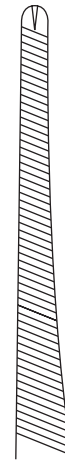

B50085
18 cm - 7"



KOCHER

Droite
Straight
Recta

Sans griffes
Without teeth
Sin dientes

A griffes
With teeth
Con dientes

 B50202	14 cm - 5 1/2"	B50200
B50207	15 cm - 6"	B50205
B50212	16 cm - 6 1/4"	B50210
B50217	18 cm - 7"	B50215
B50225	21 cm - 8 1/4"	B50220
B50231	24 cm - 9 1/2"	B50230

Mors courts - Short jaws - Boca corta

B50274	15 cm - 6"	B50272
---------------	------------	---------------



B50202
14 cm - 5 1/2"



B50274
15 cm - 6"

Mors courts - Short jaws - Boca corta



B50207
15 cm - 6"



B50212
16 cm - 6 1/4"



B50217
18 cm - 7"



B50225
21 cm - 8 1/4"



B50231
24 cm - 9 1/2"

KOCHER

Courbe
Curved
Curva

Sans griffes
Without teeth
Sin dientes

A griffes
With teeth
Con dientes

 B50236	14 cm - 5 1/2"	B50235
B50242	15 cm - 6"	B50240
B50247	16 cm - 6 1/4"	B50245
B50252	18 cm - 7"	B50250
B50257	21 cm - 8 1/4"	B50255
B50267	24 cm - 9 1/2"	B50265

Mors courts - Short jaws - Boca corta

B50278	15 cm - 6"	B50276
---------------	------------	---------------

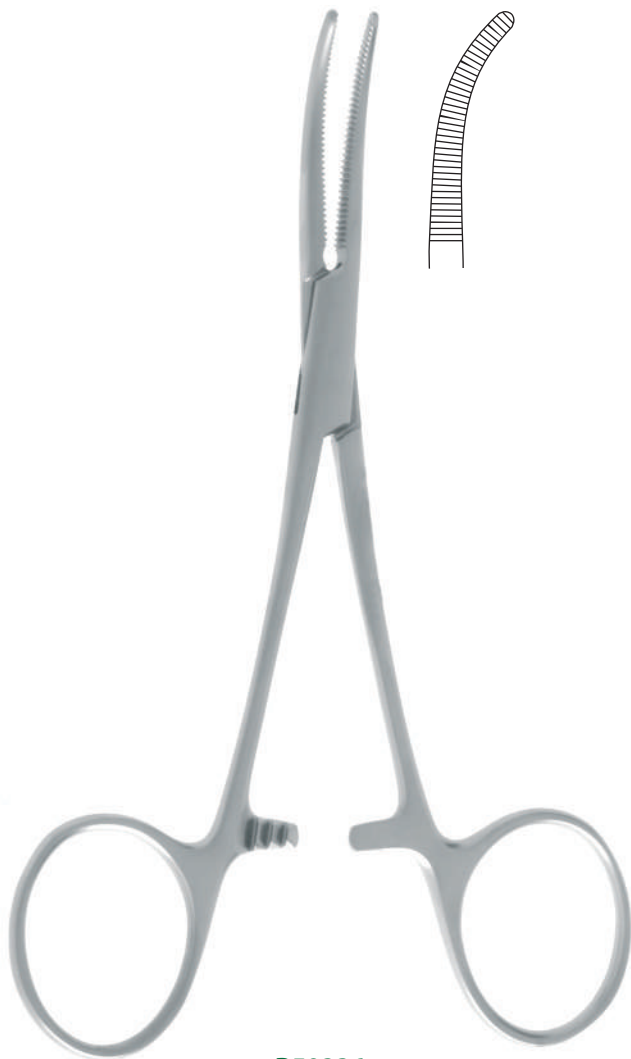

B50236
14 cm - 5 1/2"

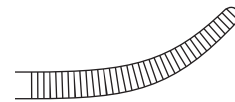

B50278
15 cm - 6"

Mors courts - Short jaws - Boca corta

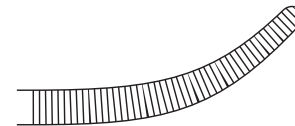

B50242
15 cm - 6"



B50247
16 cm - 6 1/4"

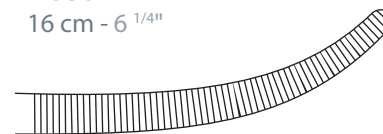

B50252
18 cm - 7"

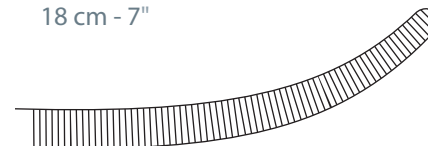

B50257
21 cm - 8 1/4"

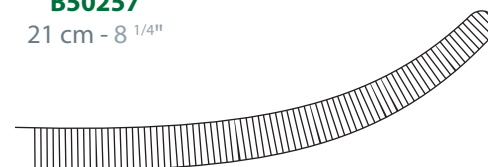

B50267
24 cm - 9 1/2"

ROCHESTER-PEAN

Droite Straight Recta	Sans griffes Without teeth Sin dientes	Courbe Curved Curva
B506990	14 cm - 5 1/2"	B507090
 B50700	16 cm - 6 1/4"	B50710
B50705	18 cm - 7"	B50715
B50706	20 cm - 8"	B50720
B507065	22 cm - 8 3/4"	B507210
B50707	24 cm - 9 1/2"	B50725
B507080	26 cm - 10 1/4"	B507261
B507081	30 cm - 11 3/4"	B507262

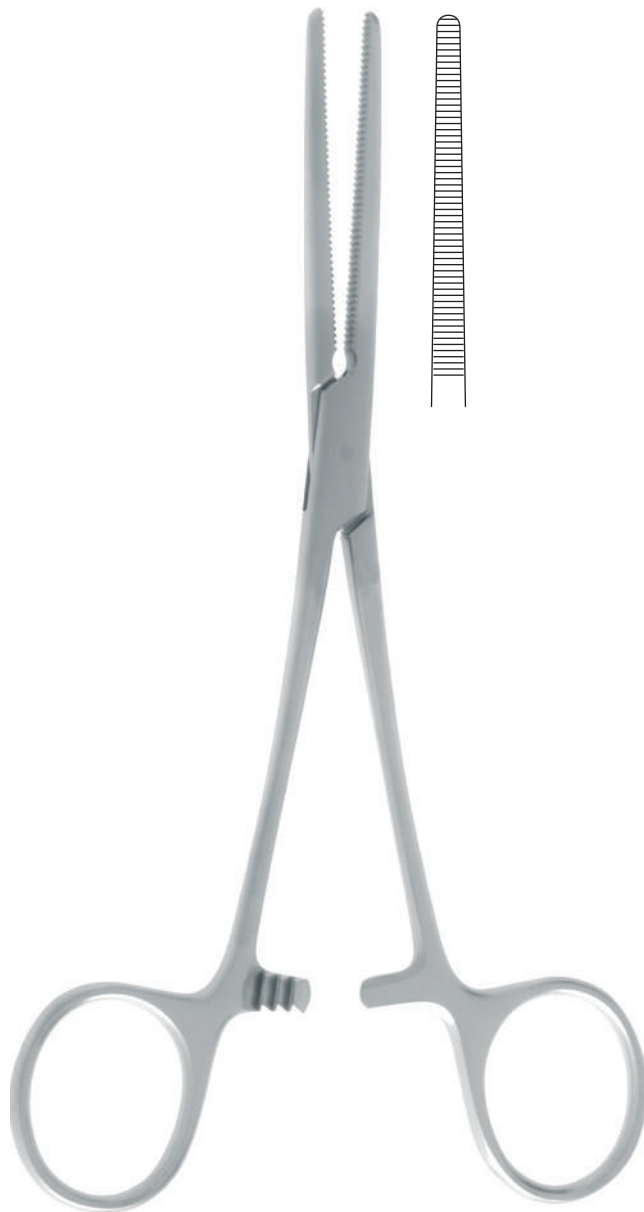

B50700
16 cm - 6 1/4"



B50705
18 cm - 7"



B50706
20 cm - 8"



B50707
24 cm - 9 1/2"

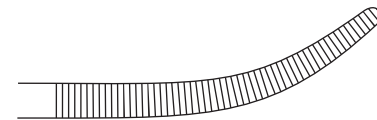

B50710
16 cm - 6 1/4"



B50715
18 cm - 7"

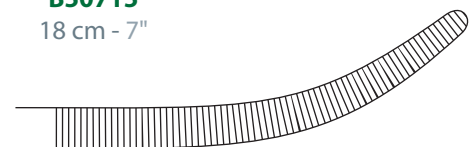

B50720
20 cm - 8"

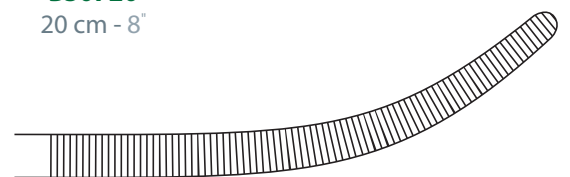

B50725
24 cm - 9 1/2"

ROCHESTER-OSCHNER

	A griffes With teeth Con dientes		Courbe Curved Curva
Droite Straight Recta			
B507295	14 cm - 5 1/2"		B507395
 B50730	16 cm - 6 1/4"		B50740
B50735	18 cm - 7"		B50745
B507351	20 cm - 8"		B507451
B507352	22 cm - 8 3/4"		B507452
B507353	24 cm - 9 1/2"		B507453
B507354	26 cm - 10 1/4"		B507454
B507355	30 cm - 11 3/4"		B507455



B50730
16 cm - 6 1/4"



B50730
16 cm - 6 1/4"



B50735
18 cm - 7"



B507351
20cm - 8"



B507353
24cm - 9 1/2"

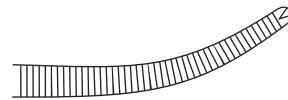

B50740
16 cm - 6 1/4"



B50745
18 cm - 7"

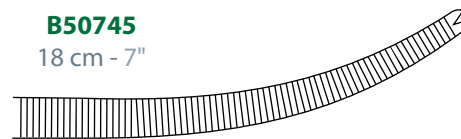

B507451
20 cm - 8"

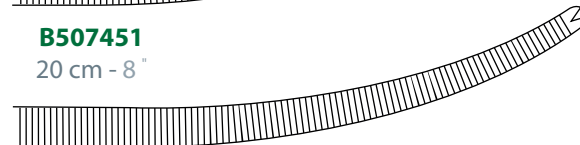

B507453
24 cm - 9 1/2"



ROCHESTER-CARMALT

Droite
Straight
Recta

Courbe
Curved
Curva



B50746

16 cm - 6 1/4"

B50747



B50748

20 cm - 8"

B50749



B50748
20 cm - 8"

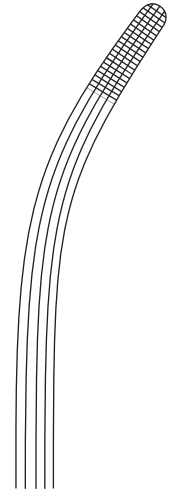
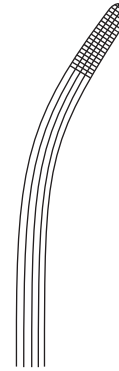

B50749
20 cm - 8"

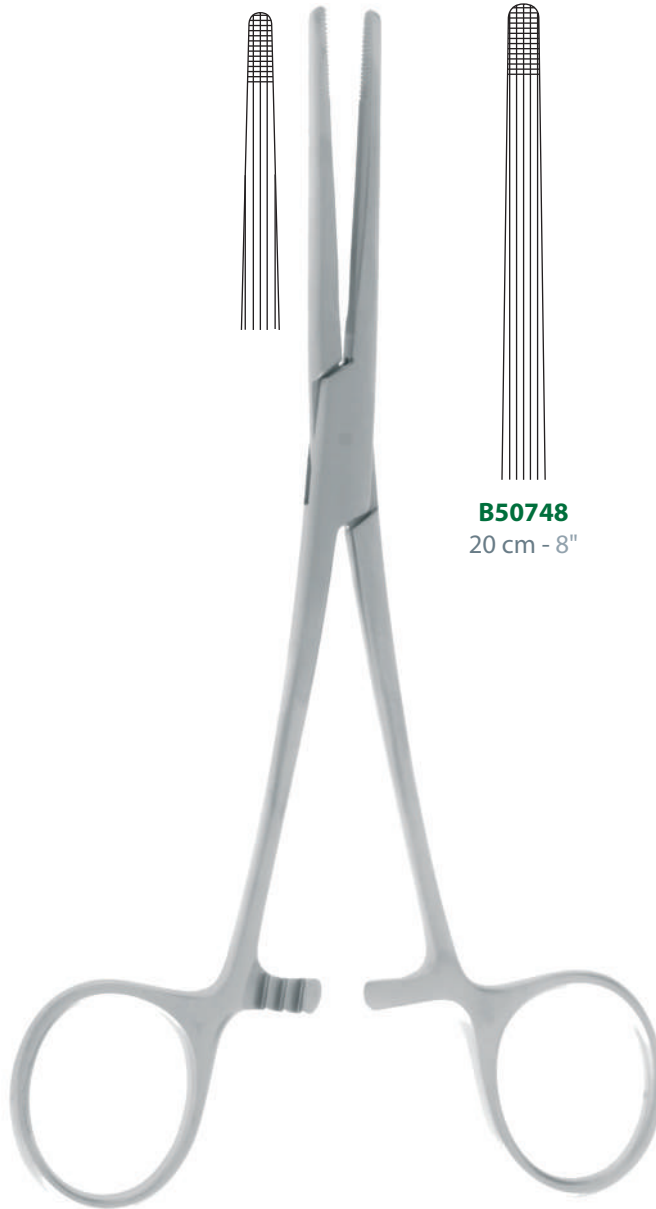

B50746
16 cm - 6 1/4 "

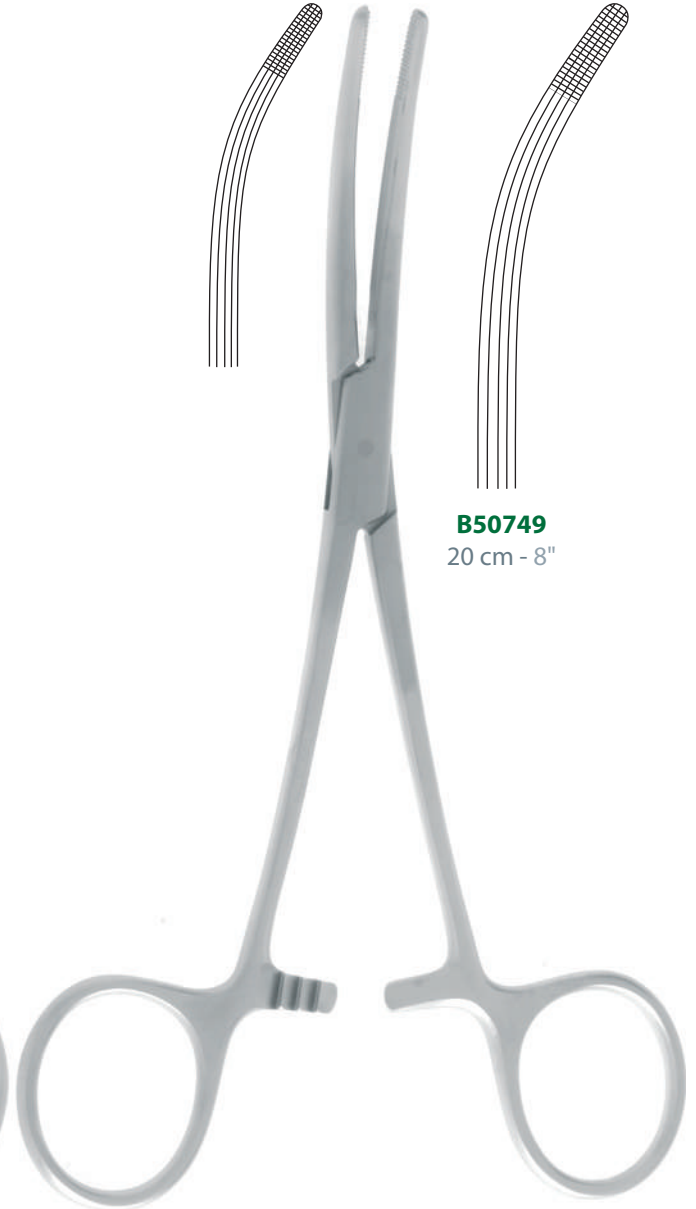

B50747
16 cm - 6 1/4 "

TERRIER

SPENCER WELLS



B50455
12 cm - 4 ³/₄"



B50465
12 cm - 4 ³/₄"

CARREL

TERRIER

Sans griffes
Without teeth
Sin dientes

A griffes
With teeth
Con dientes



B504500
11 cm - 4 1/4"



B504510
10 cm - 4"

KRÔNLEIN

DUNHILL



B504520
13 cm - 5"

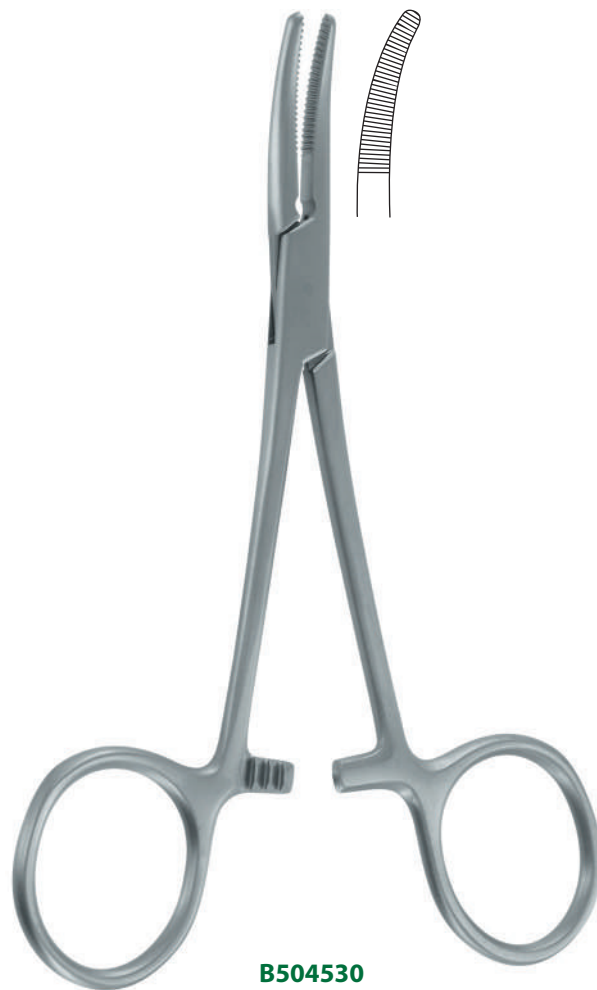

B504530
13 cm - 5"

SPENCER WELLS

Sans griffes
Without teeth
Sin dientes

Droite Straight Recta		Courbe Curved Curva
 B504651	13 cm - 5"	B504661 
B504652	15 cm - 6"	B504662
B504653	18 cm - 7"	B504663
B504654	20 cm - 8"	B504664

Modèle allemand
German model
Modelo alemán

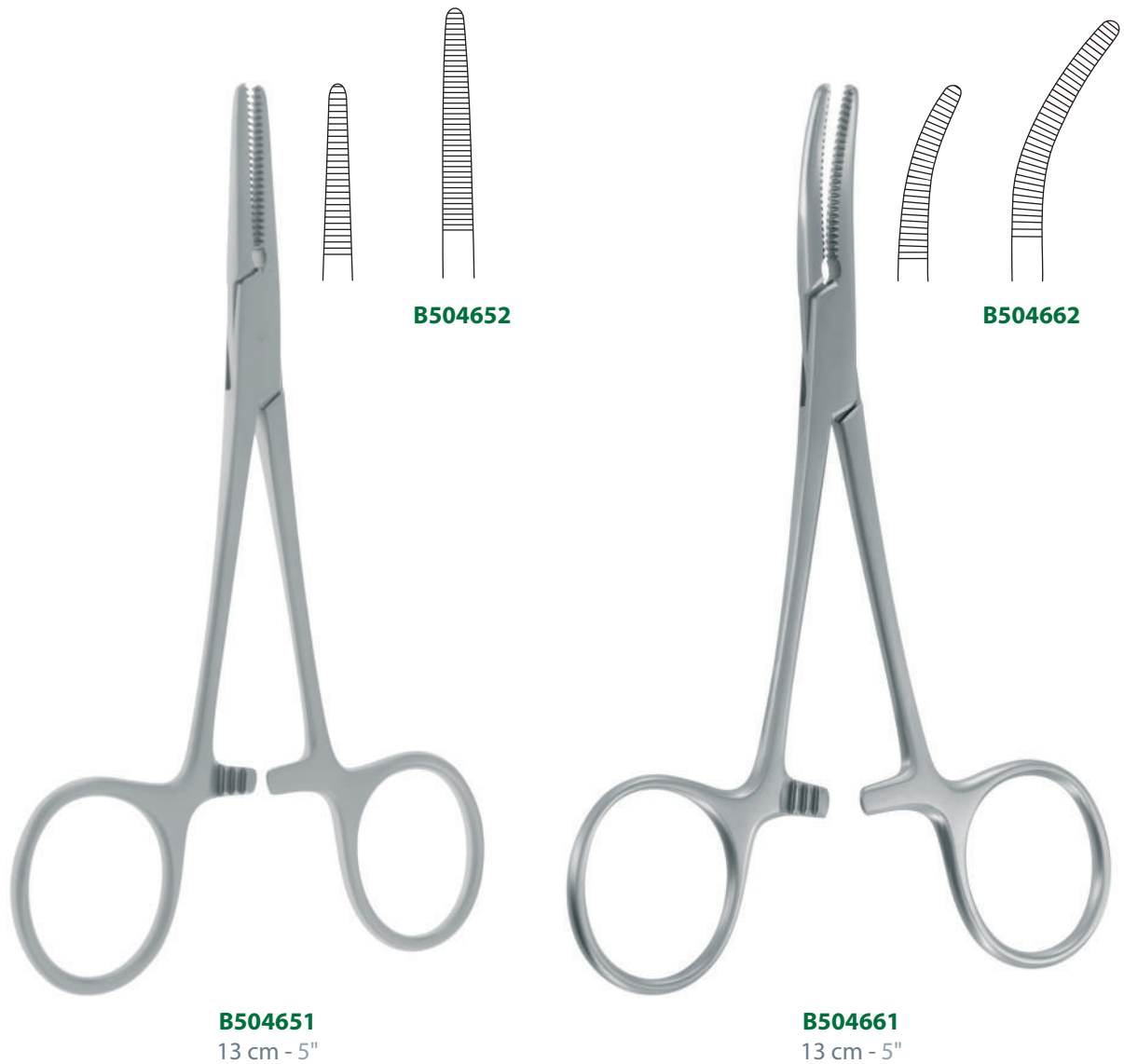

Pinces hémostatiques - Haemostatic forceps - Pinzas hemostáticas

Droite
Straight
Recta

MOSQUITO

Courbe
Curved
Curva

Sans griffes - Without teeth - Sin dientes



B50435
10 cm - 4"



B50445
10 cm - 4"

A griffes - With teeth - Con dientes



B50430
10 cm - 4"



B50440
10 cm - 4"

IV - Pinces
IV - Forceps
IV - Pinzas

MICRO-HALSTEAD

Sans griffes - Without teeth - Sin dientes

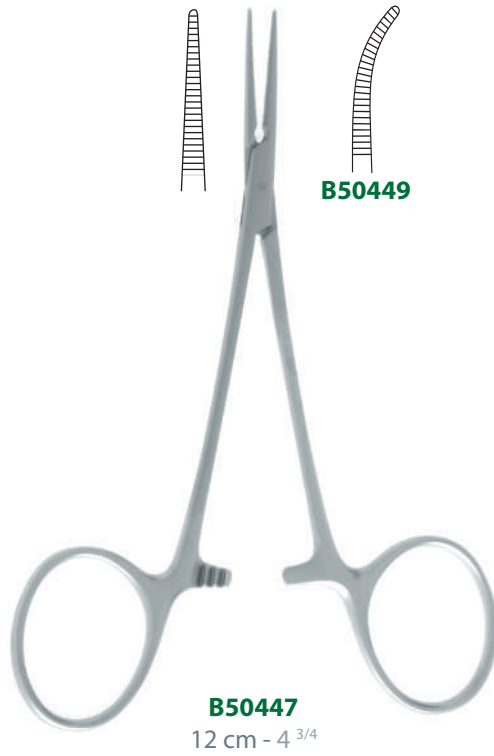

B50449

A griffes - With teeth - Con dientes

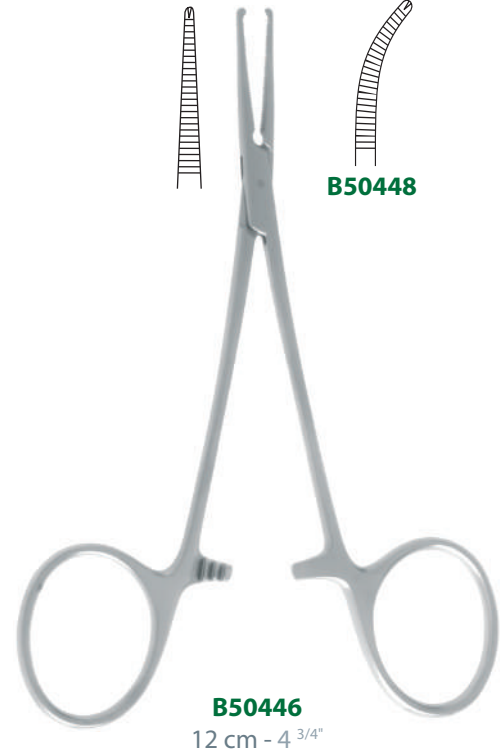

B50448

HALSTEAD

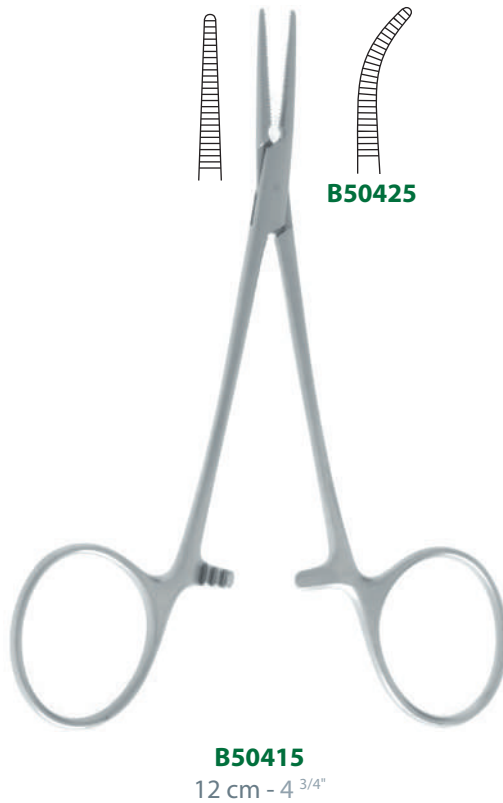

B50425



B50420

MICRO-MOSQUITO

Sans griffes - Without teeth - Sin dientes

A griffes - With teeth - Con dientes

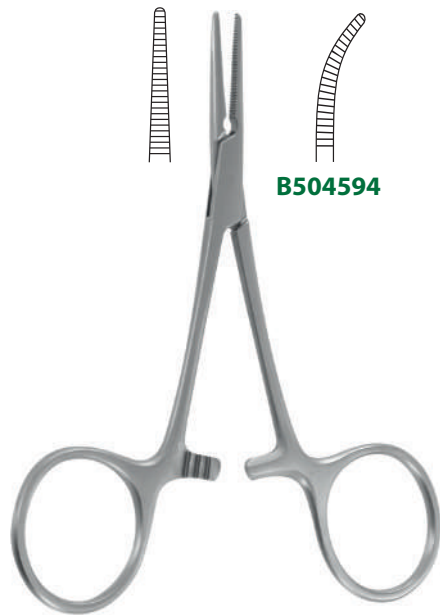

B504594



B504596

B504590
10 cm - 4"

Modèles allemands
German models
Modelos alemanes

B504592
10 cm - 4"



B504595



B504597

B504591
12 cm - 4 ³/₄"

B504593
12 cm - 4 ³/₄"

JACOBSON HALSTEAD

Modèles allemands
 German models
 Modelos alemanés

Sans griffes - Très fine
 Without teeth - Very fine
 Sin dientes - Muy fino





B504598
 13 cm - 5"



B504599
 13 cm - 5"

Pinces hémostatiques - Haemostatic forceps - Pinzas hemostáticas

		HALSTEAD-MOSQUITO					
		Droite Straight Recta		Courbe Curved Curva			
		Sans griffes Without teeth Sin dientes	A griffes With teeth Con dientes	Sans griffes Without teeth Sin dientes	A griffes With teeth Con dientes		
		B504580	B504582	12 cm - 4 ³ / ₄ "	B504584	B504586	
		B504581	B504583	14 cm - 5 ¹ / ₂ "	B504585	B504587	
		B504560	B504564	18 cm - 7"	B504562	B504566	
		B504561	B504565	21 cm - 8 ¹ / ₄ "	B504563	B504567	

Modèles allemands
German models
Modelos alemanes

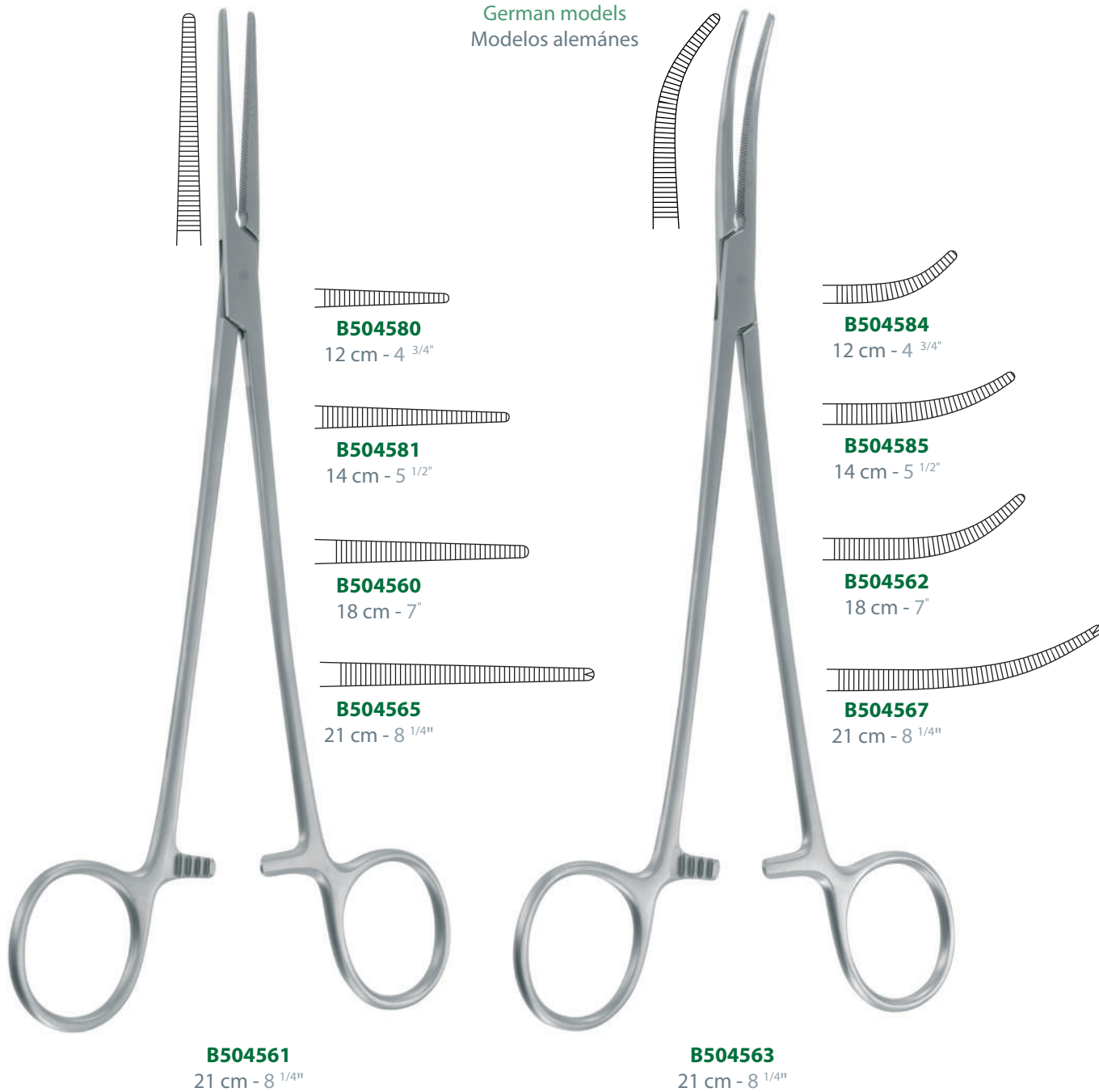

IV - Pinces
IV - Forceps
IV - Pinzas

BONNIOT

Droite
Straight
Recta

Courbe
Curved
Curva

Sans griffes
Without teeth
Sin dientes

A griffes
With teeth
Con dientes

Sans griffes
Without teeth
Sin dientes

A griffes
With teeth
Con dientes



B503000

B503001

15 cm - 6"



B503010

B503011



B503000
15 cm - 6"



B503010
15 cm - 6"

LERICHE

Droite
Straight
Recta

Courbe
Curved
Curva

Sans griffes Without teeth Sin dientes		A griffes With teeth Con dientes			Sans griffes Without teeth Sin dientes		A griffes With teeth Con dientes	
	B50345	B50330		15 cm - 6"		B50375	B50360	
	B50350	B50335		18 cm - 7"		B50380	B50365	

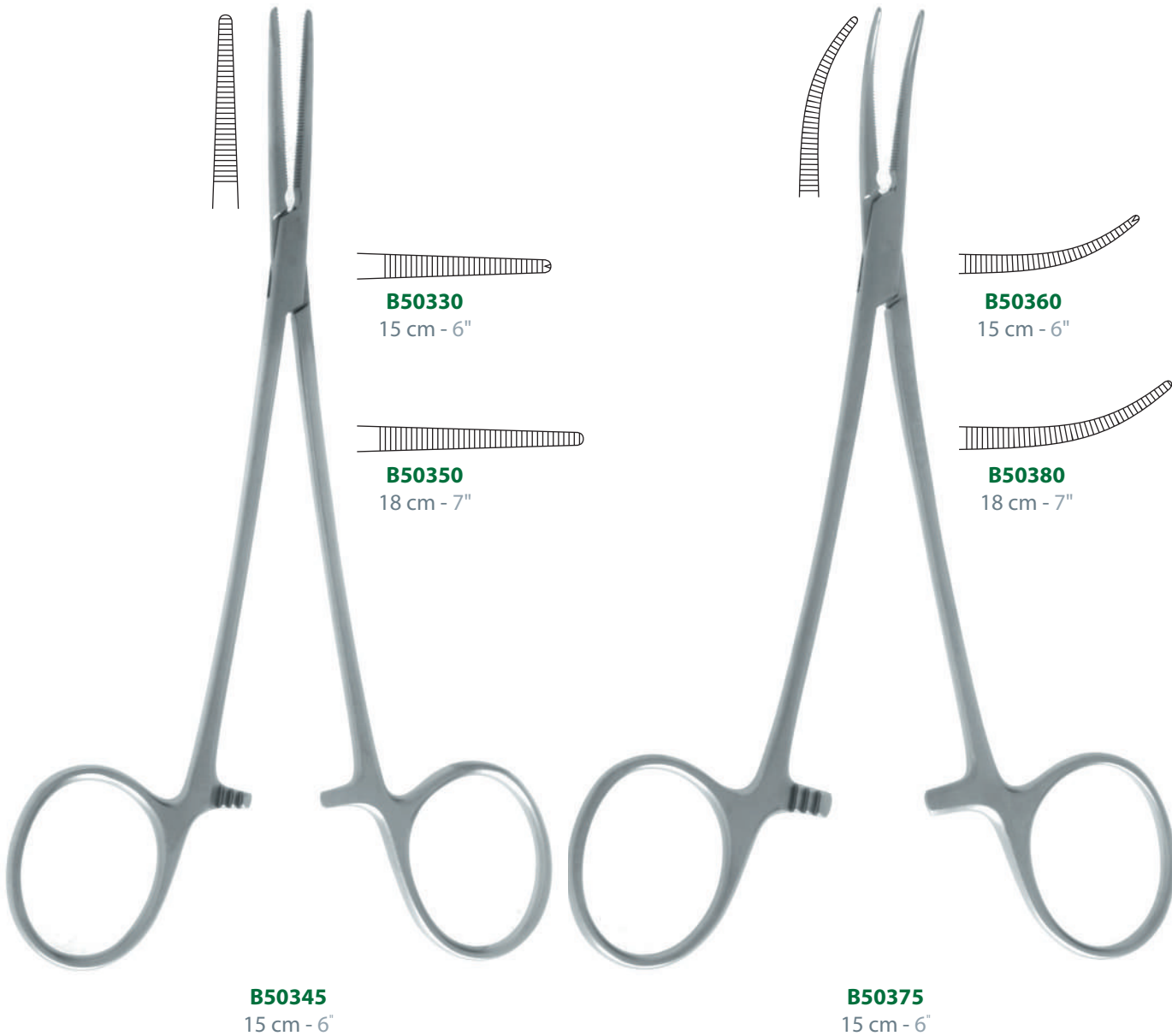

IV - Pinces
IV - Forceps
IV - Pinzas

Pinces hémostatiques - Haemostatic forceps - Pinzas hemostáticas

PROVIDENCE

Droite	Courbe
Straight	Curved
Recta	Curva

14 cm - 5 1/2"

B508400

B508401



DANDY

Sans griffes	A griffes
Without teeth	With teeth
Sin dientes	Con dientes

14 cm - 5 1/2"

B508450

B508451



MOSQUITO-DANDY

12 cm - 4 3/4"

B508455

-

Courbe latérale
Lateral curved
Curva lateral

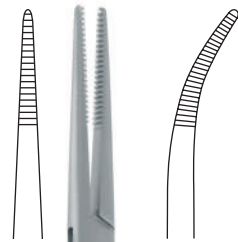

B508401



B508400
14 cm - 5 1/2"

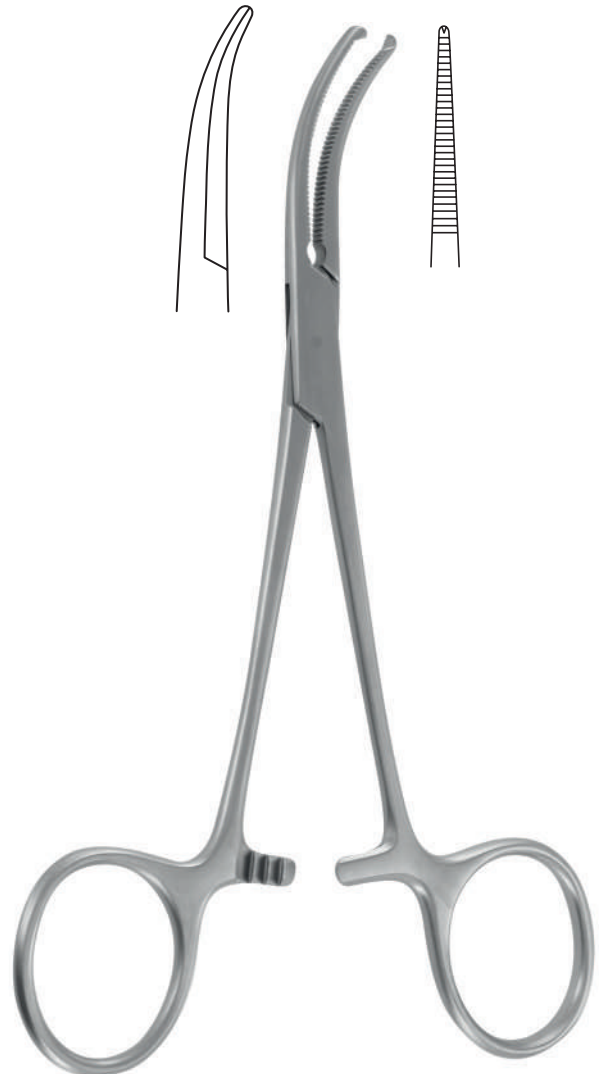
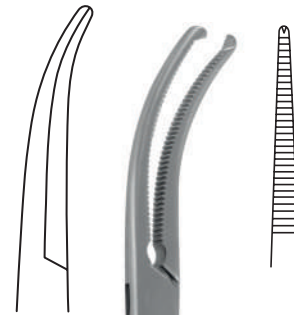

B508451
14 cm - 5 1/2"

DIXON-LOVELACE

Droite
Straight
Recta

Courbe
Curved
Curva

Sans griffes
Without teeth
Sin dientes

A griffes
With teeth
Con dientes

Sans griffes
Without teeth
Sin dientes

A griffes
With teeth
Con dientes



B50284

B50282

16 cm - 6 1/4"



B50288

B50286



B50282





B50286

B50284
16 cm - 6 1/4"

B50288
16 cm - 6 1/4"



CRILE

Droite Straight Recta		Courbe Curved Curva	
Sans griffes Without teeth Sin dientes	A griffes With teeth Con dientes	Sans griffes Without teeth Sin dientes	A griffes With teeth Con dientes
 B50680	B50660	 B50690	B50670
B50685	B50665	B50695	B50675
		14 cm - 5 1/2"	
		16 cm - 6 1/4"	

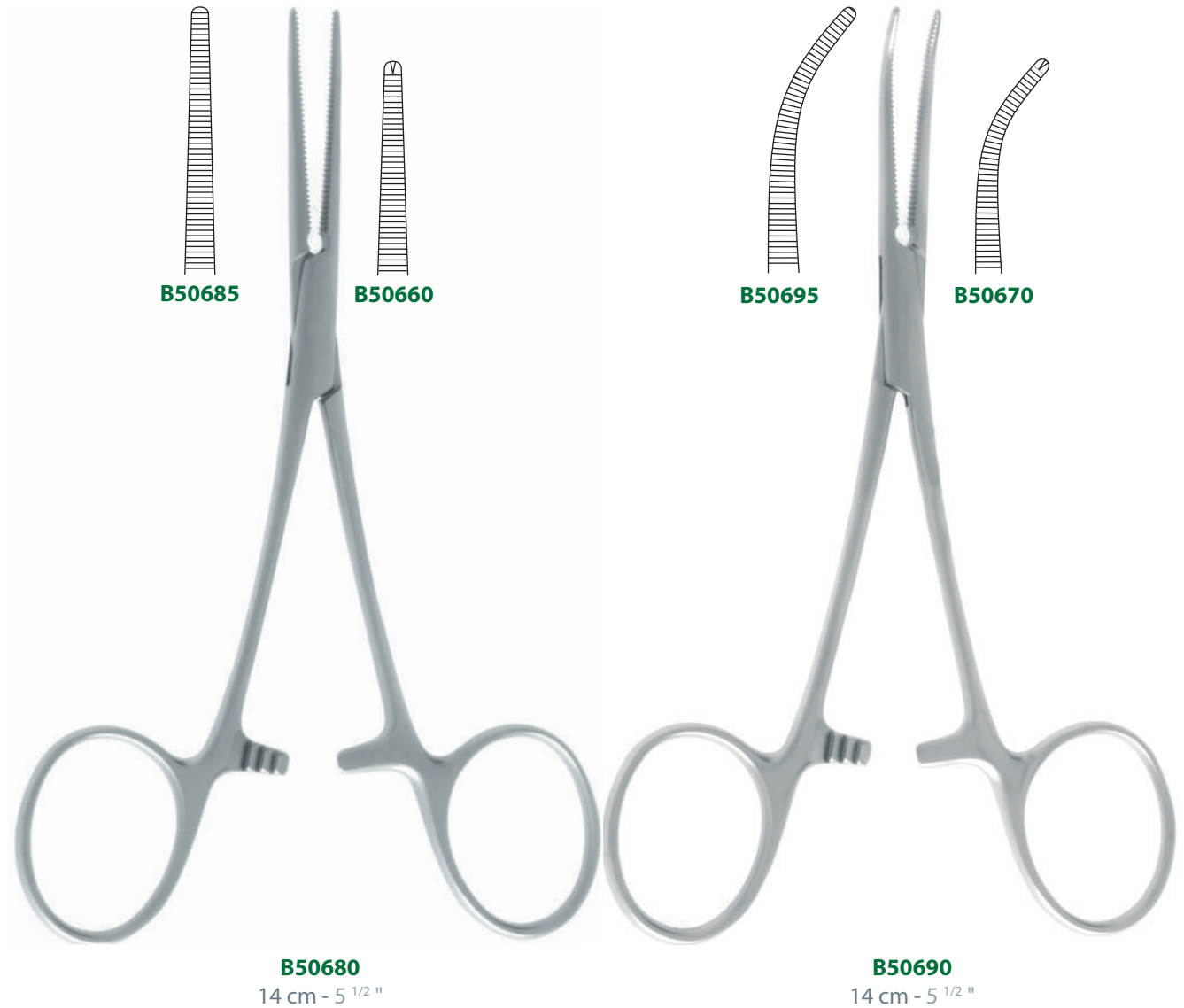

Pinces hémostatiques - Haemostatic forceps - Pinzas hemostáticas

CRILE

Droite
Straight
Recta

B506953

Courbe
Curved
Curva

B506954

A griffes
With teeth
Con dientes

Sans griffes
Without teeth
Sin dientes



B506951

B506952

14 cm - 5 1/2"

CRILE-RANKIN

Droite
Straight
Recta

B506957

Courbe
Curved
Curva

B506958

B506955

B506956



16 cm - 6 1/4"

Modèle allemand
German model
Modelo alemán

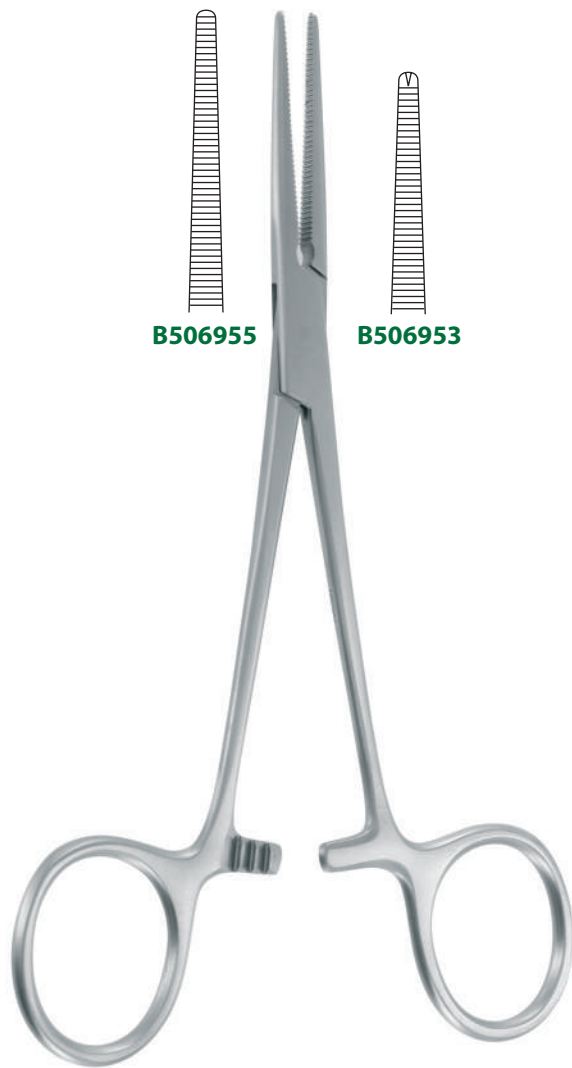
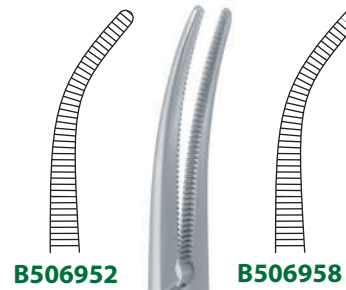
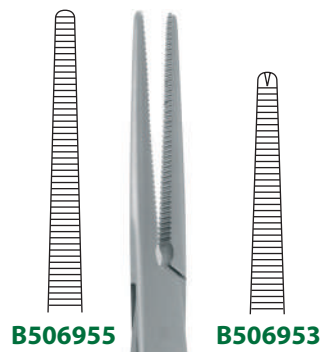

B506951
14 cm - 5 1/2"



B506956
16 cm - 6 1/4"

IV - Pinces
IV - Forceps
IV - Pinzas

Pinces hémostatiques - Haemostatic forceps - Pinzas hemostáticas

COLLER-CRILE

Droite Straight Recta	Sans griffes Without teeth Sin dientes	Courbe Curved Curva
B506966	14 cm - 5 1/2"	 B506968
B506967	16 cm - 6 1/4"	B506969

BABY-CRILE

Droite Straight Recta	Sans griffes Without teeth Sin dientes	Courbe Curved Curva
 B506960	B506961	B506961
B506962	A griffes With teeth Con dientes	B506963

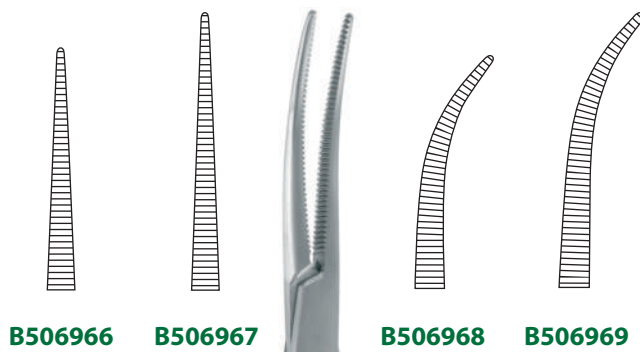

B506966

B506967

B506968

B506969



B506968

14 cm - 5 1/2"

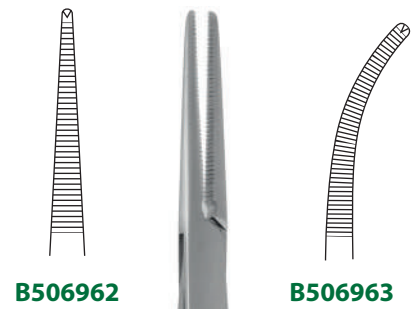

B506962



B506963



B506960

14 cm - 5 1/2"

KELLY

Droite Straight Recta		Courbe Curved Curva	
A griffes With teeth Con dientes	Sans griffes Without teeth Sin dientes	A griffes With teeth Con dientes	Sans griffes Without teeth Sin dientes
B50555	B50575 	B50595	B50615 
B50560	B50580	B50600	B50620
B50565	B50585	B50605	B50625
B50570	B50590	B50610	B50630

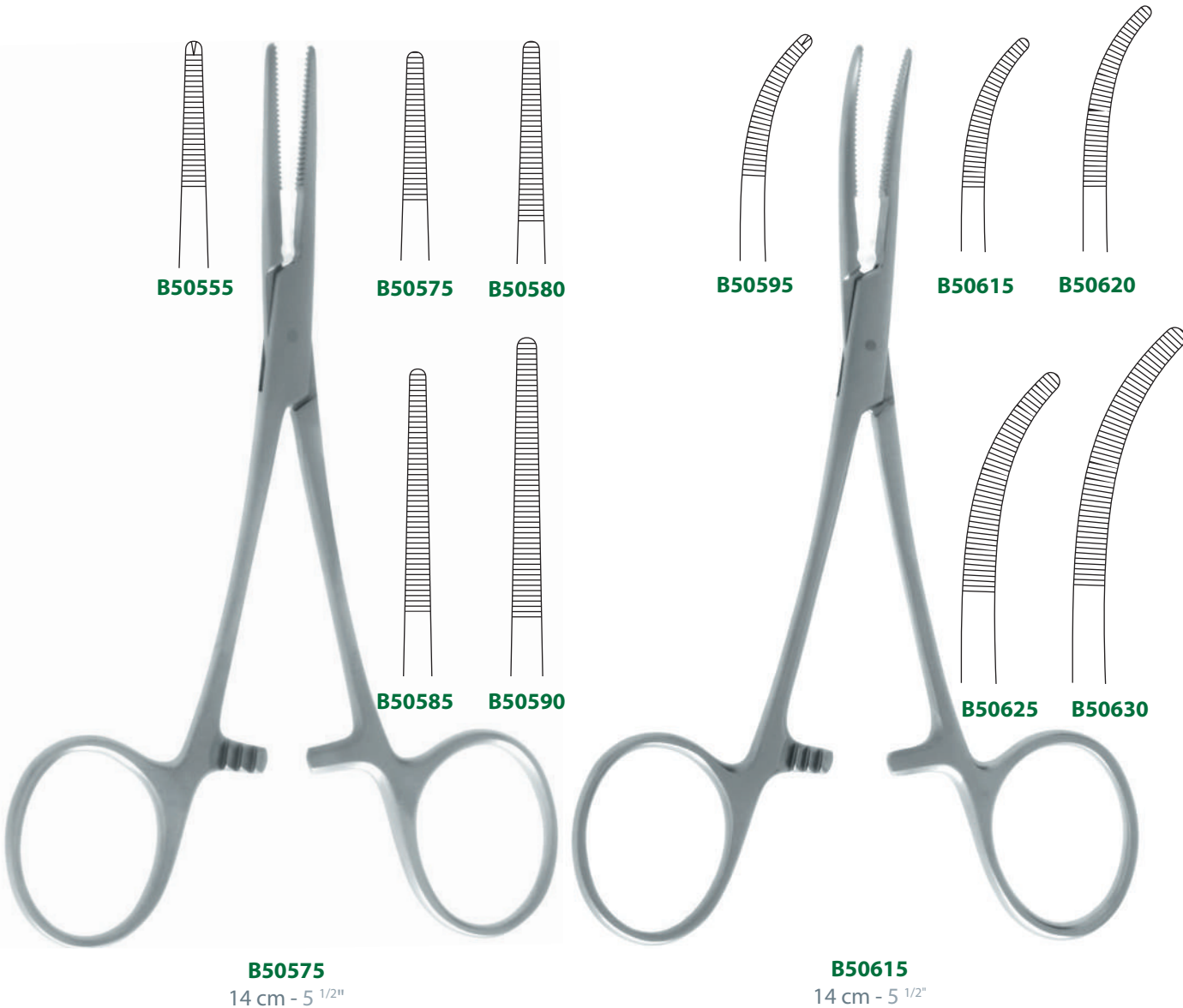

B50575
14 cm - 5 1/2"

B50615
14 cm - 5 1/2"



KELLY-RANKIN



B50632
16 cm - 6 1/4"

B50634
16 cm - 6 1/4"

IV - Pinces
IV - Forceps
IV - Pinzas

CHRISTOPHE

Droite
Straight
Recta

Sans griffes
Without teeth
Sin dientes



B50755

A griffes
With teeth
Con dientes

B50750

16 cm - 6 1/4"

Courbe
Curved
Curva

Sans griffes
Without teeth
Sin dientes



B50765

A griffes
With teeth
Con dientes

B50760



B50750

B50760

B50755
16 cm - 6 1/4"

B50765
16 cm - 6 1/4"

Pinces hémostatiques - Haemostatic forceps - Pinzas hemostáticas

FUCHSIG

Sans griffes
Without teeth
Sin dientes



B609095
19 cm - 7 1/2"

BIRKETT

Droite
Straight
Recta



B609096

19 cm - 7 1/2"

Courbe
Curved
Curva

B609097



B609096

B609097

B609096
19 cm - 7 1/2"

Pinces hémostatiques - Haemostatic forceps - Pinzas hemostáticas

ADSON

Droite
Straight
Recta

Courbe
Curved
Curva

À griffes - With teeth - Con dientes

B609100 18,5 cm - 7 1/4" **B609101**

Sans griffes - Without teeth - Sin dientes

 **B609102** 18,5 cm - 7 1/4" **B609103**

NISSEN

Sans griffes
Without teeth
Sin dientes

18,5 cm - 7 1/4" **B609112** 

22,5 cm - 9" **B609113**



B609102

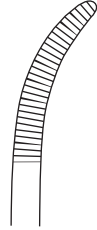

B609103

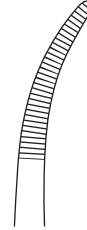

B609112

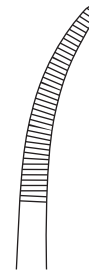

B609113



B609102
18,5 cm - 7 1/4"



B609112
18,5 cm - 7 1/4"



MOYNIHAN

Courbe latérale
Lateral curved
Curva lateral



B50457
14 cm - 5^{1/2}"



B50458
15 cm - 6"

CAIRNS

Droite
Straight
Recta



B504540

Courbe
Curved
Curva



B504545 

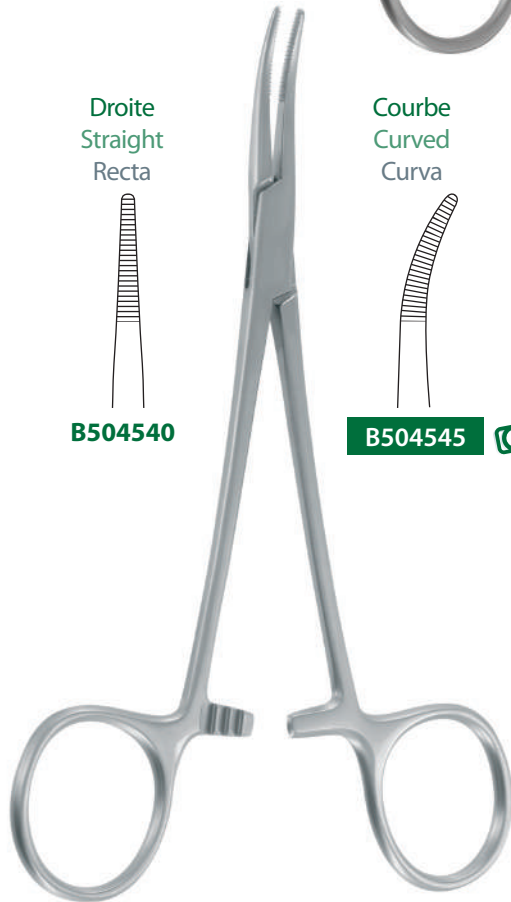

B504545
15 cm - 6"

BRIDGE





B609108
28 cm - 11"

B609109
28 cm - 11"





Pinces hémostatiques longues - Long haemostatic forceps - Pinzas hemostáticas largas

HEISS

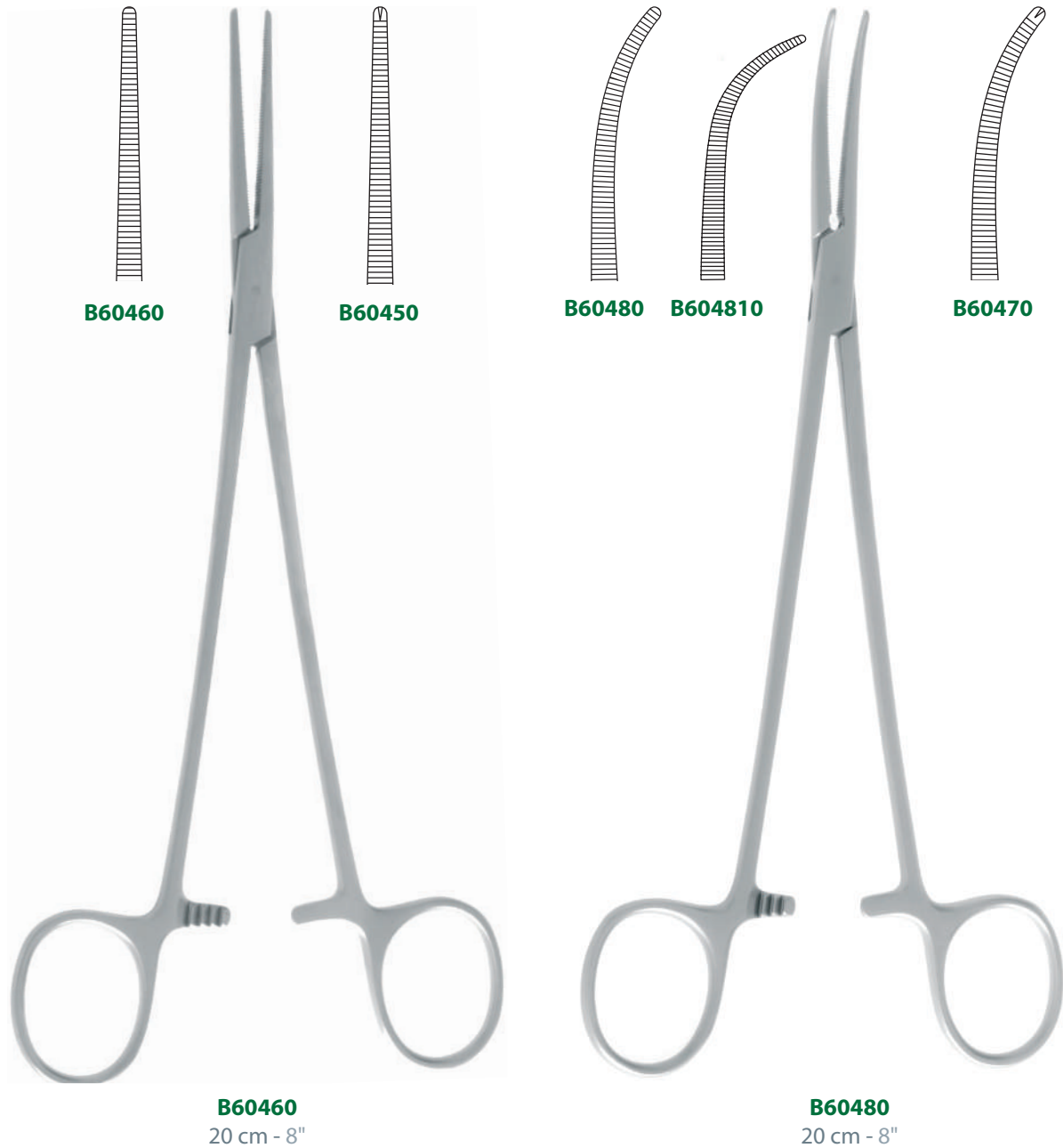
Droite Straight Recta		Courbe Curved Curva	
Sans griffes Without teeth Sin dientes	A griffes With teeth Con dientes	Sans griffes Without teeth Sin dientes	A griffes With teeth Con dientes
 B60460	B60450	 B60480	B60470
20 cm - 8"		B604810	



BENGOLEA

Droite Straight Recta		Courbe Curved Curva	
Sans griffes Without teeth Sin dientes	A griffes With teeth Con dientes	Sans griffes Without teeth Sin dientes	A griffes With teeth Con dientes
 B60180	B60140	 B60260	B60220
B60190	B60150	B60270	B60230
B60200	B60160	B60280	B60240
	21 cm - 8 1/4"		
	24 cm - 9 1/2"		
	30 cm - 11 3/4"		

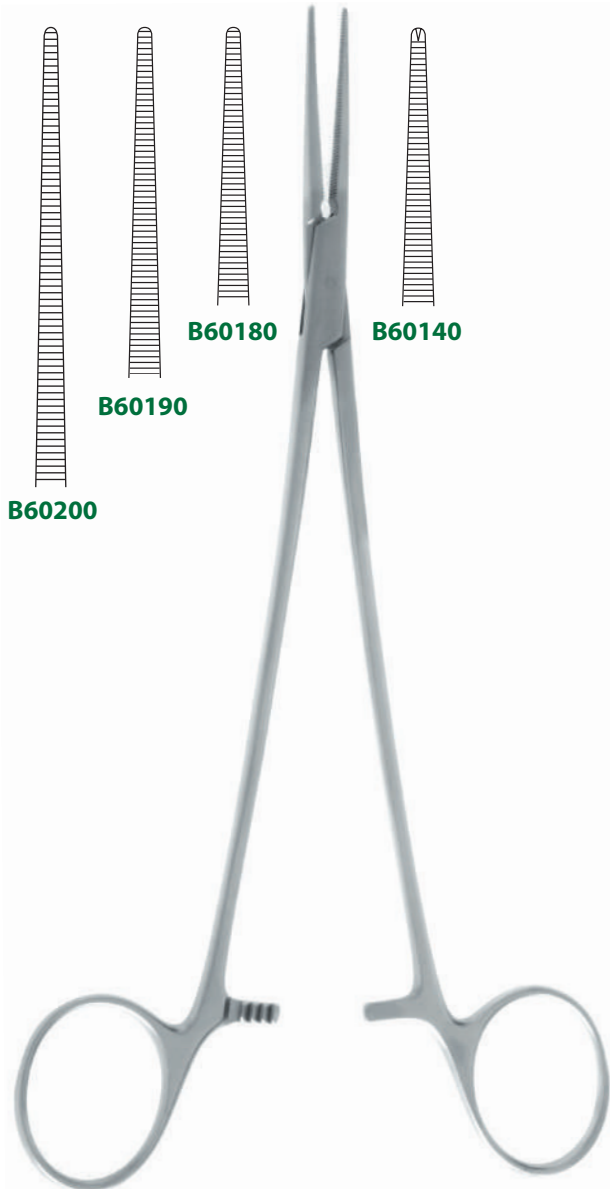

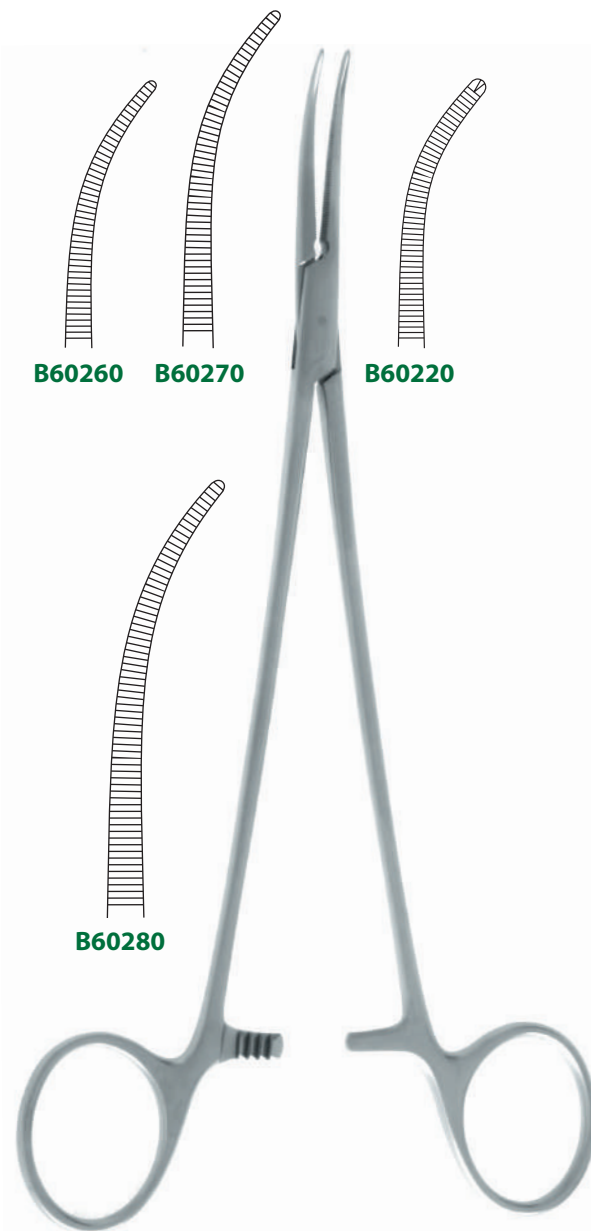

B60180
21 cm - 8 1/4"



B60260
21 cm - 8 1/4"

IV - Pinces
IV - Forceps
IV - Pinzas

BENGOLEA

Droite Straight Recta		Courbe Curved Curva	
Sans griffes Without teeth Sin dientes	A griffes With teeth Con dientes	Sans griffes Without teeth Sin dientes	A griffes With teeth Con dientes
B602900	B602908	B602904	B602912
 B602902	B602910	 B602906	B602914
		20 cm - 8"	
		24 cm - 9 1/2"	

Modèle allemand
German model
Modelo alemán

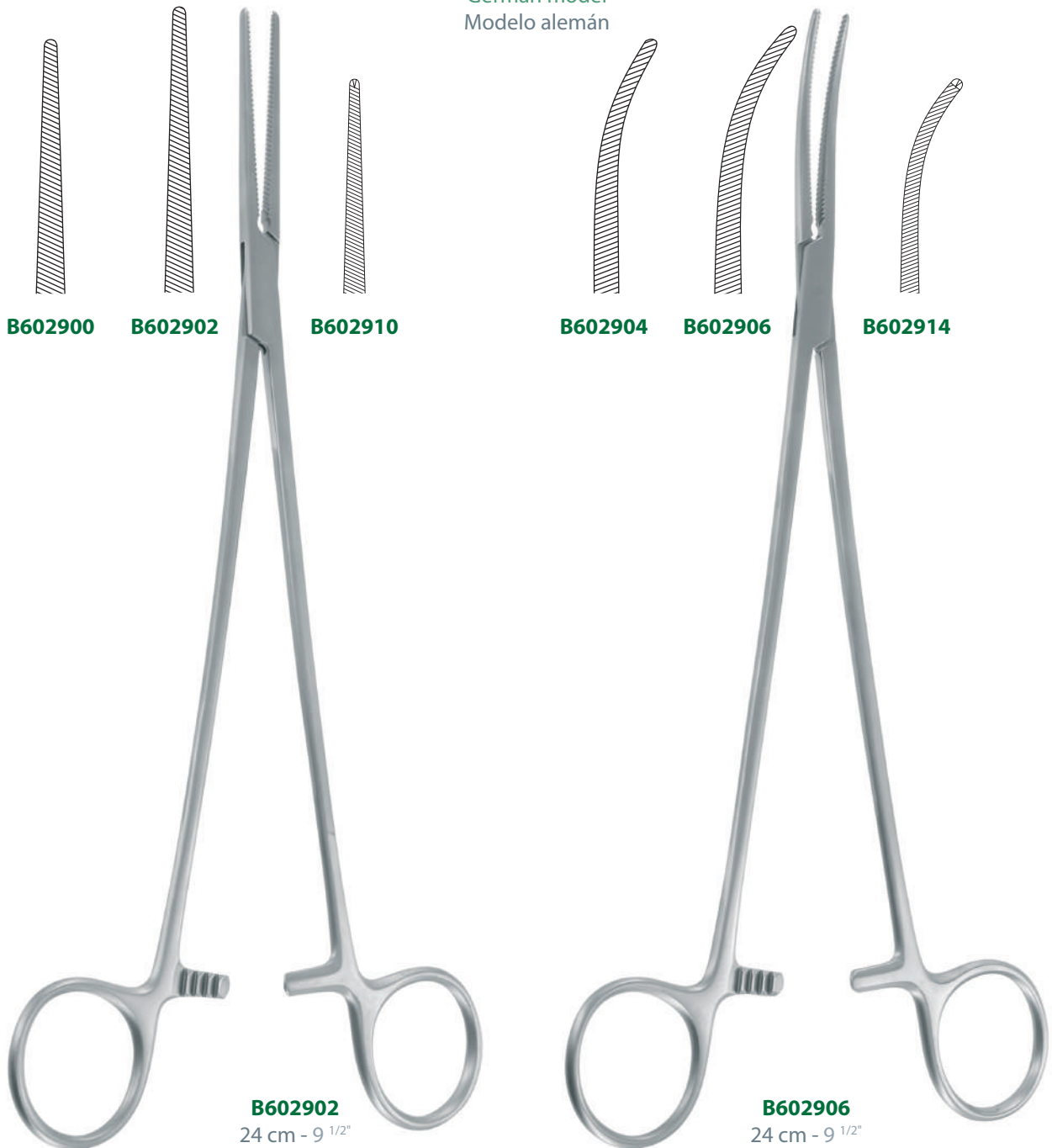

IV - Pinces
IV - Forceps
IV - Pinzas

Pinces hémostatiques longues - Long haemostatic forceps - Pinzas hemostáticas largas

ROBERTS

Droite
Straight
Recta

Courbe
Curved
Curva



B609110

22 cm - 8 ³/₄"

B609111

Sans griffes
Without teeth
Sin dientes

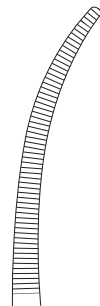

B609111



B609110
22 cm - 8 ³/₄"

SAROT

Droite
Straight
Recta

Courbe
Curved
Curva



B609115

24 cm - 9 ¹/₂"

B609116

Sans griffes
Without teeth
Sin dientes

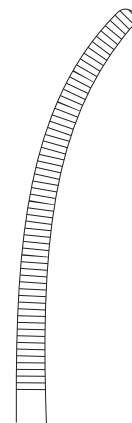

B609116



B609115
24 cm - 9 ¹/₂"

IV - Pinces
IV - Forceps
IV - Pinzas

SANTY

Sans griffes
Without teeth
Sin dientes

B60340

24 cm - 9 1/2"

A griffes
With teeth
Con dientes

B60330



B60360

30 cm - 11 3/4"



B60350

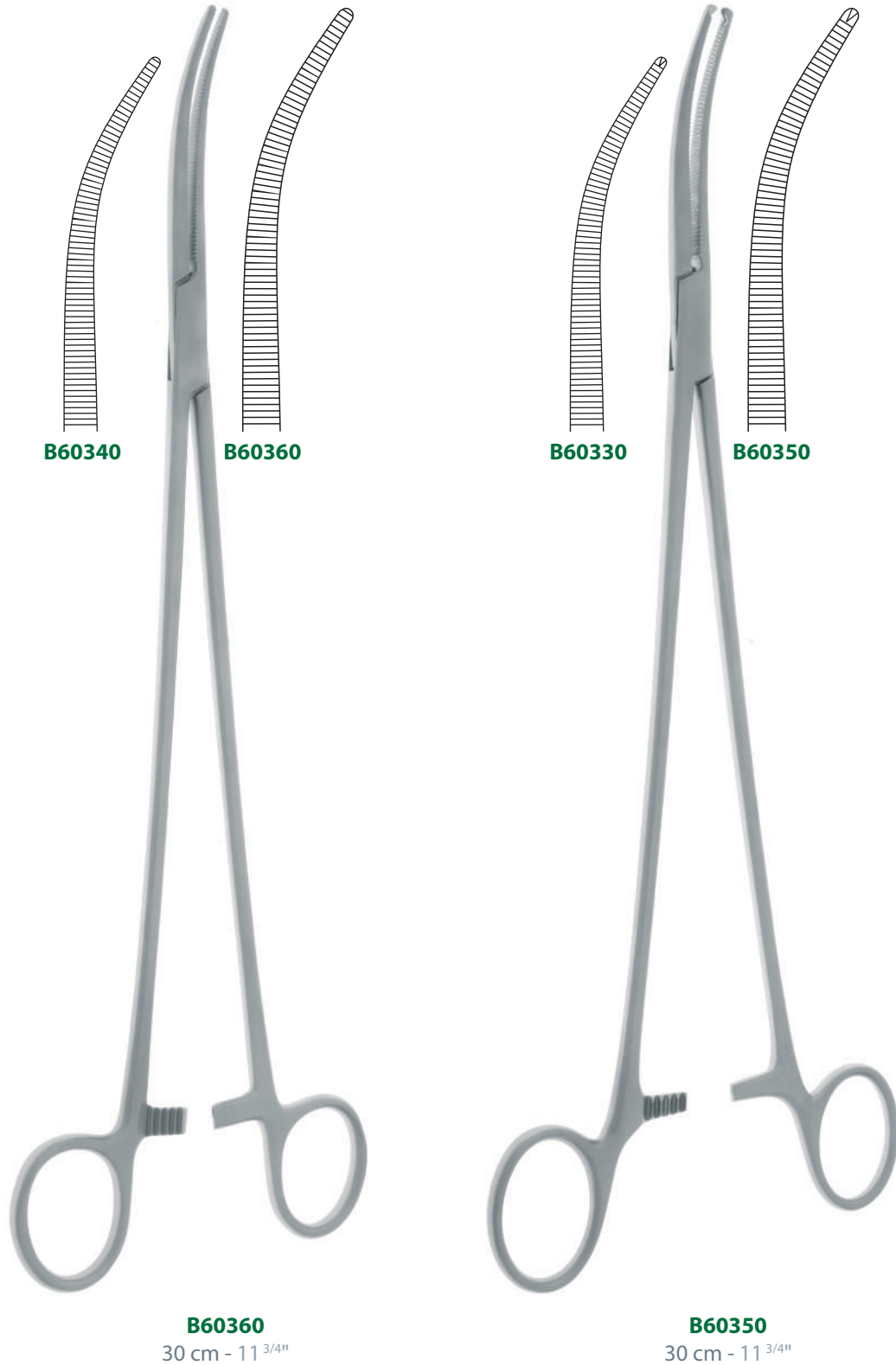

B60340

B60360

B60330

B60350

B60360

30 cm - 11 3/4"

B60350

30 cm - 11 3/4"

Pinces hémostatiques longues - Long haemostatic forceps - Pinzas hemostáticas largas

MOYNIHAN

23 cm - 9"

B604390

24 cm - 9 1/2"

B60440 

CRAFOORD

18 cm - 7"

B609122

24 cm - 9 1/2"

B609123 

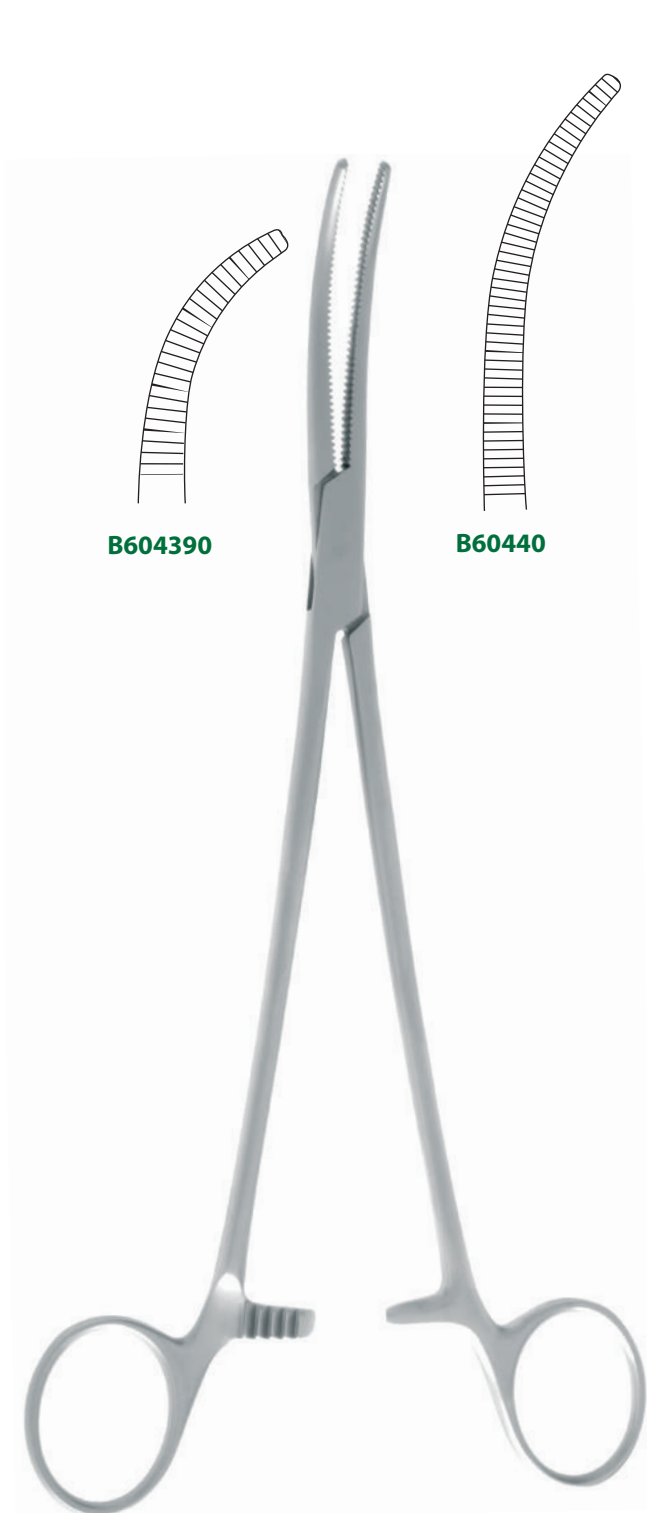

B60440
24 cm - 9 1/2"



B609123
24 cm - 9 1/2"

IV - Pinces
IV - Forceps
IV - Pinzas

BAINBRIDGE

Droite
Straight
Recta

Courbe
Curved
Curva

B508000

15 cm - 6"

B508002



B508001

18 cm - 7"

B508003



B508000

B508001

B508002

B508003

B508001
18 cm - 7"

B508003
18 cm - 7"

CRAFOORD (SELLORS)

Droite
Straight
Recta

1/2 Courbe
1/2 Curved
1/2 Curva

Courbe
Curved
Curva

Très courbe
Very curved
Muy curva



B60770

24 cm - 9 1/2"

B60790

24 cm - 9 1/2"

B607901

23 cm - 9"

B607902

22 cm - 8 3/4"



B60770

24 cm - 9 1/2"



B60770

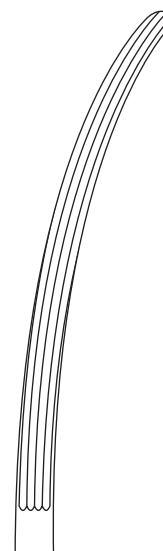

B60790

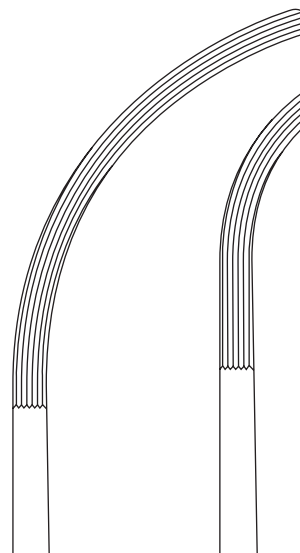

B607901

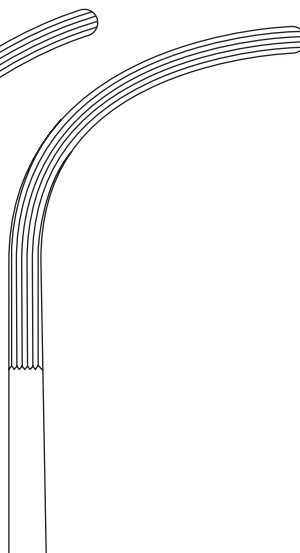

B607902



MICHON

LEGUEU

A doigt
Collin's lock
Desmontable



B55260
24 cm - 9 1/2"



B55280
22 cm - 8 2/3"

GOUILLOUD

TOUPET

A doigt
Collin's lock
Desmontable

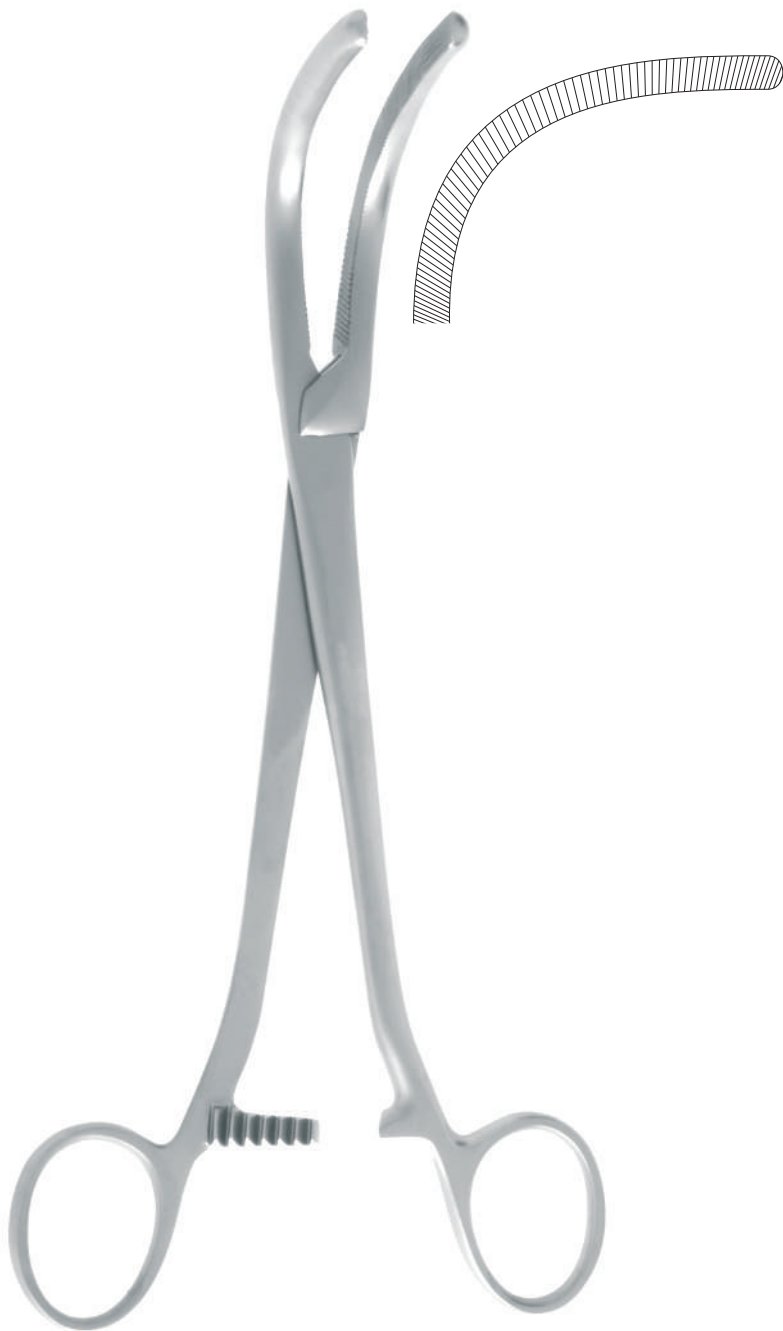

B55300
22 cm - 8 3/4"



B55310
24 cm - 9 1/2"

IV - Pinces
IV - Forceps
IV - Pinzas

MIKULICZ

Pinces pour le péritoine
Peritoneal forceps
Pinzas para peritoneo

Courbe latérale
Lateral curved
Curva lateral

18 cm - 7"

B507661

20 cm - 8"

B50767

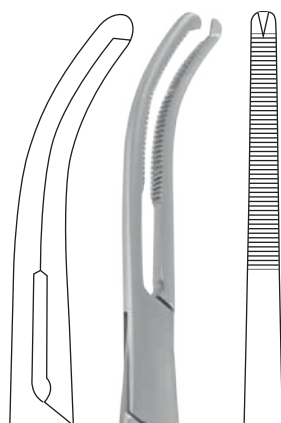

Courbe
Curved
Curva



BABY-MIKULICZ

Courbe
Curved
Curva

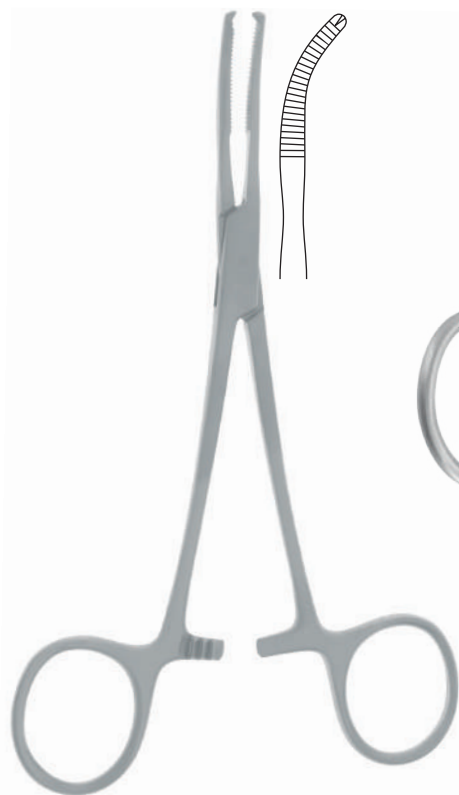

B507660
14 cm - 5 1/2"

B507662
18 cm - 7"

B50767
20 cm - 8"

MIKULICZ

Pinces pour le péritoine
Peritoneal forceps
Pinzas para peritoneo

A griffes
With teeth
Con dientes

Courbe
Curved
Curva

Très courbe
Very curved
Muy curva



B507680

B507680
18 cm - 7"



B507690

B507695

B507690
20 cm - 8"

IV - Pinces
IV - Forceps
IV - Pinzas

BABY-ADSON

14 cm - 5 1/2"

B605300 

18 cm - 7"

B605301

REDON

Courbe
Curved
Curva

Très courbe
Very curved
Muy curva



B60535
14 cm - 5 1/2"



B605300
14 cm - 5 1/2"

O 'SHAUGNESSY

	45° Fin 45° Fine 45° Fino	90° Fin 90° Fine 90° Fino
14 cm - 5 1/2"	B60540	B60601
16 cm - 6 1/4"	B60545	B60602 
18 cm - 7"	B60550	B60603
20 cm - 8"	B60560	B60604
22 cm - 8 3/4"	B60570	B60605
24 cm - 9 1/2"	B60580	B60606
28 cm - 11"	B60590	B60607
30 cm - 11 3/4"	B60600	B60608



B60545
16 cm - 6 1/4"



B60602
16 cm - 6 1/4"

O'SHAUGNESSY

	45° Fort 45° Strong 45° Fuerte	90° Fort 90° Strong 90° Fuerte
14 cm - 5 1/2"	B60610	B60710
16 cm - 6 1/4"	B60615	B60715 
18 cm - 7"	B60620	B60720
20 cm - 8"	B60630	B60730
22 cm - 8 3/4"	B60640	B60740
24 cm - 9 1/2"	B60650	B60750
28 cm - 11"	B60660	B60752
30 cm - 11 3/4"	B60670	B60753



B60615
16 cm - 6 1/4"

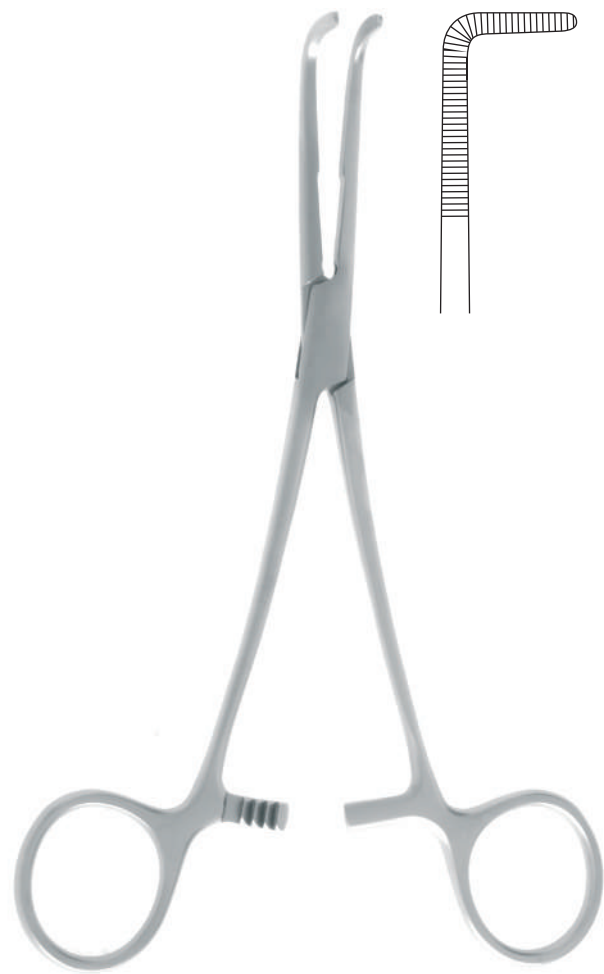

B60715
16 cm - 6 1/4"

O'SHAUGNESSY

ALLAINE

21,5 cm - 8 1/2"

B60894



26,5 cm - 10 1/2"

B60895

Double courbure
Double bend
Dobla curvatura

Très courbe
Very curved
Muy curva

Double courbure
Double bend
Dobla curvatura



B60700
24 cm - 9 1/2"

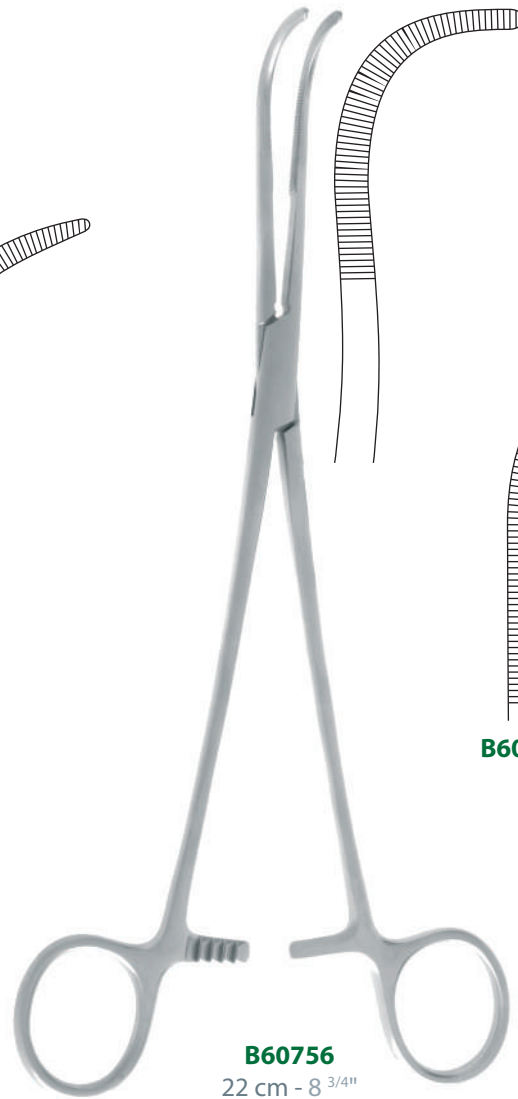

B60756
22 cm - 8 3/4"

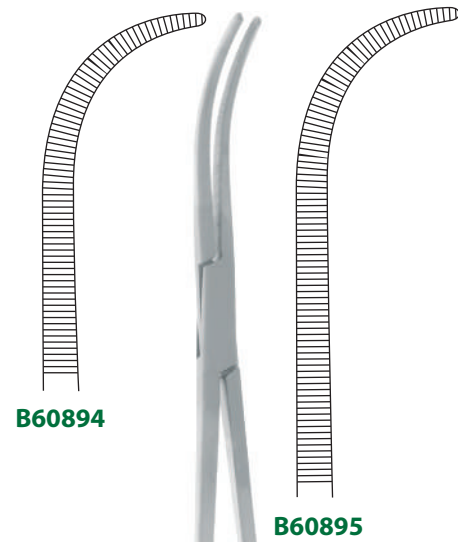

B60894

B60895

B60894
21,5 cm - 8 1/2"

OVERHOLT-GEISSENDORFER

21 cm - 8 1/4"	B612100	B612110	B612120	B612130	B612140	B612150	B612160
27 cm - 10 1/2"	B612700	B612710	B612720	B612730	B612740	B612750	B612760



B612100
21 cm - 8 1/4"

OVERHOLT-SLIM

B605000	18,5 cm - 7 1/4"
B605001	20,5 cm - 8"
B605002	21 cm - 8 1/4"
B605003	21,5 cm - 8 1/2"
-	24 cm - 9 1/2"

Double courbure
Double bend
Doble curvatura

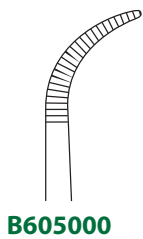

B605000

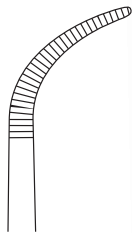

B605001

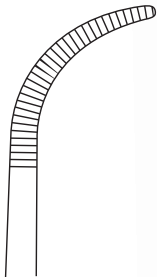

B605002

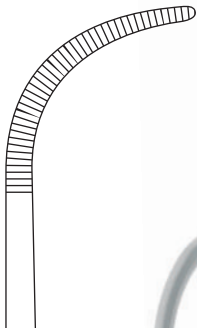

B605003

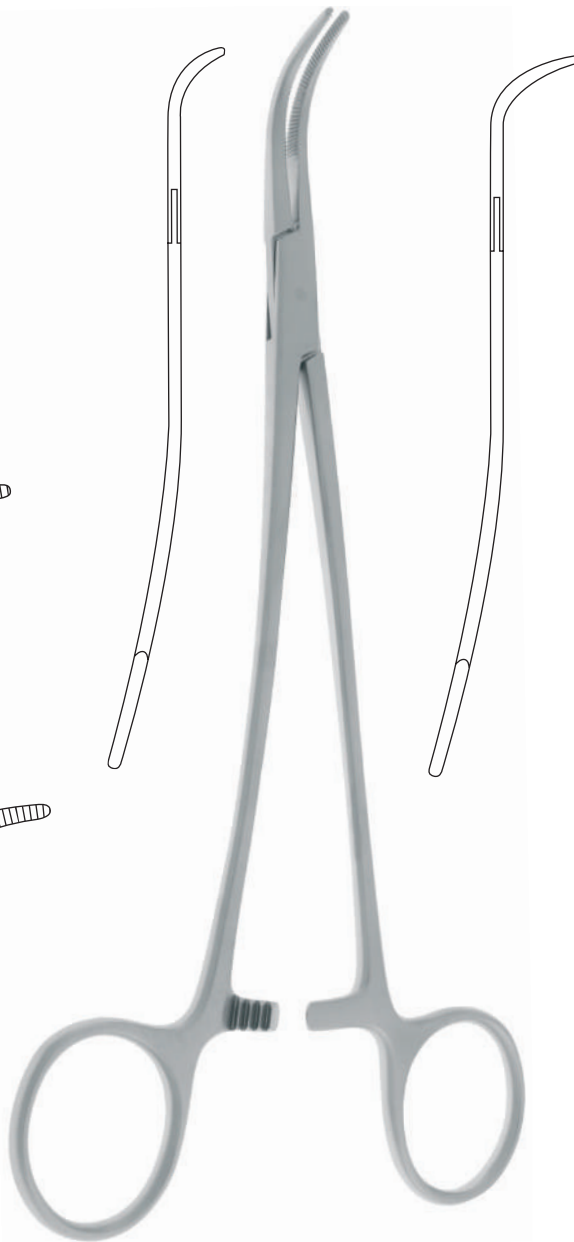

B605005
20,5 cm - 8"

OVERHOLT-S

B605004
B605005 
B605006
B605007
B605008

Courbe "S"
"S" curved
Curva "S"

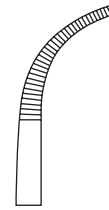

B605004

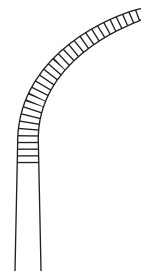

B605005

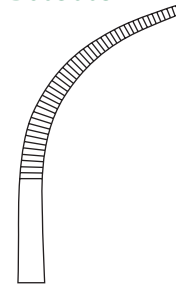

B605006

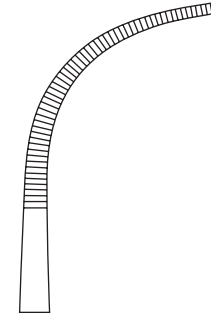

B605007

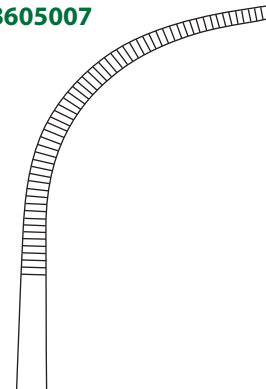

B605008

SCHNIDT

JACOBSON-ADSON

19 cm - 7 1/2"

B609000

B609001

18 cm - 7"

B609104

B609105

B609106

Très fine
Very fine
Muy finas

Courbe
Curved
Curva

Très courbe
Very curved
Muy curva

Droite
Straight
Recta

1/2 Courbe
1/2 Curved
1/2 Curva

Courbe
Curved
Curva



B609000

B609001



B609104

B609105

B609106

B609000
19 cm - 7 1/2"

B609105
18 cm - 7"

LANDANGER

Pinces passe-fils, dissecteurs - Ligature forceps, dissectors - Disecadores

GEMINI

Très courbe
Very curved
Muy curva

13 cm - 5"	B605250 
18 cm - 7"	B605251
20 cm - 8"	B605252
23 cm - 9"	B605253
25 cm - 10"	B605254
28 cm - 11"	B605255

MINI GEMINI

Très courbe
Very curved
Muy curva

18 cm - 7"	B605256 
22 cm - 8 3/4"	B605257
25 cm - 10"	B605258
28 cm - 11"	B605259

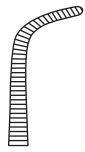

B605250

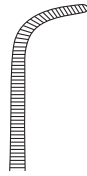

B605251

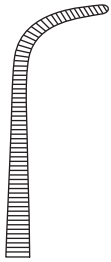

B605252

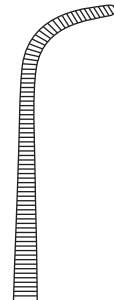

B605253



B605254

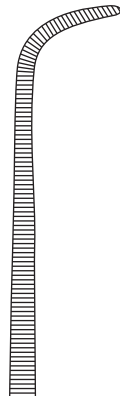

B605255

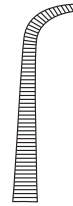

B605256

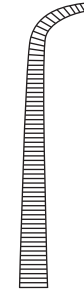

B605257

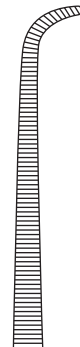

B605258

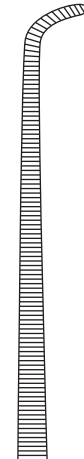

B605259

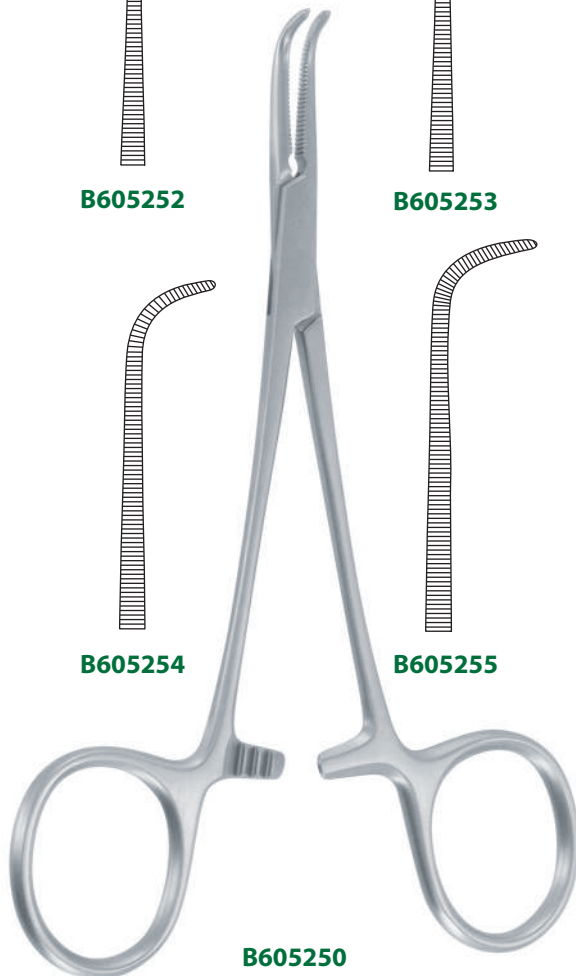

B605250
13 cm - 5"

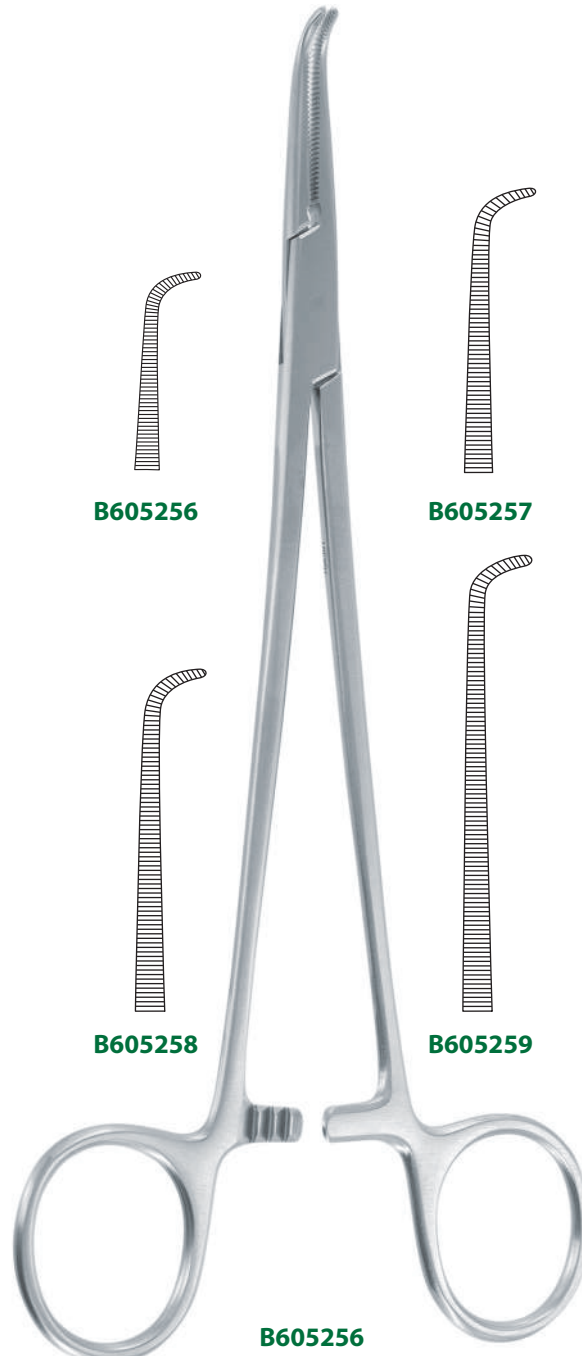

B605256
18 cm - 7"

IV - Pinces
IV - Forceps
IV - Pinzas

BABY-MIXTER

Courbe Très courbe
Curved Very curved
Curva Muy curva

14 cm - 5 1/2"

B609125

B609126

18 cm - 7"

B609127

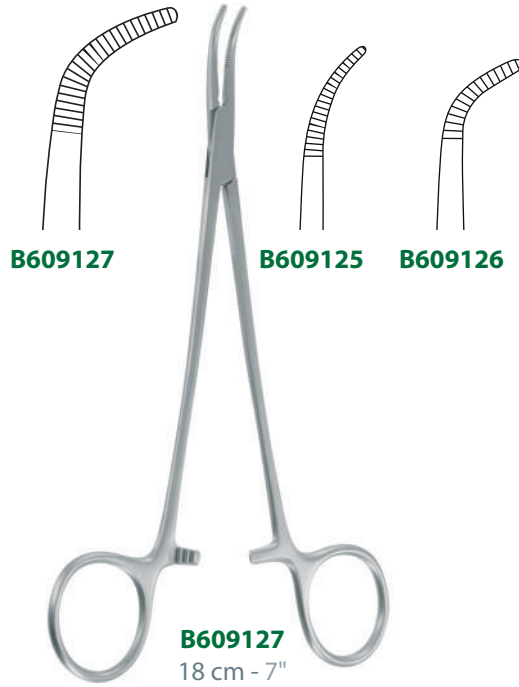

MIXTER

15 cm - 6"

B609129

19 cm - 7 1/2"

B609130

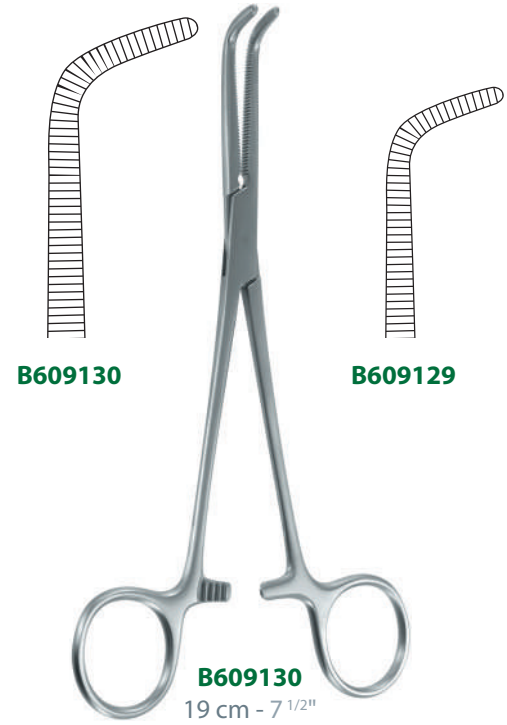

BABY-OVERHOLT

Très courbe
Very curved
Muy curva



MIXTER-O'SHAUGNESSY

15,5 cm - 6 1/2"

B609135

19 cm - 7 1/2"

B609140

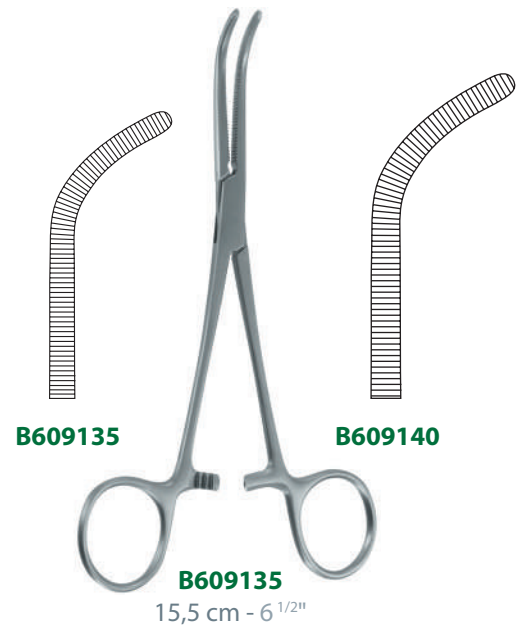

WICKSTROEM



LOWER



MIXTER

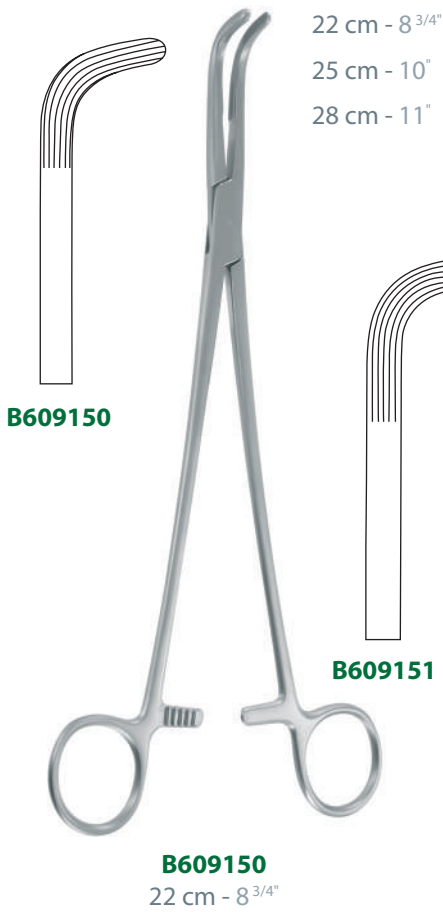

- B609150**
- B609151**
- B609152**

22 cm - 8 3/4"
25 cm - 10"
28 cm - 11"

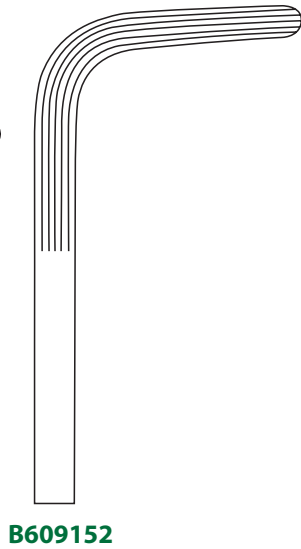
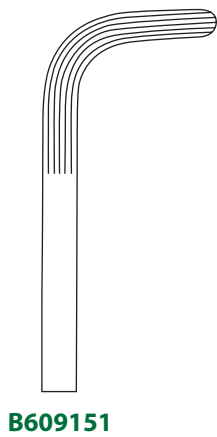

IV - Pincas
IV - Forceps
IV - Pinzas

LAWRENCE



ZENKER



LAHEY (SWEET)

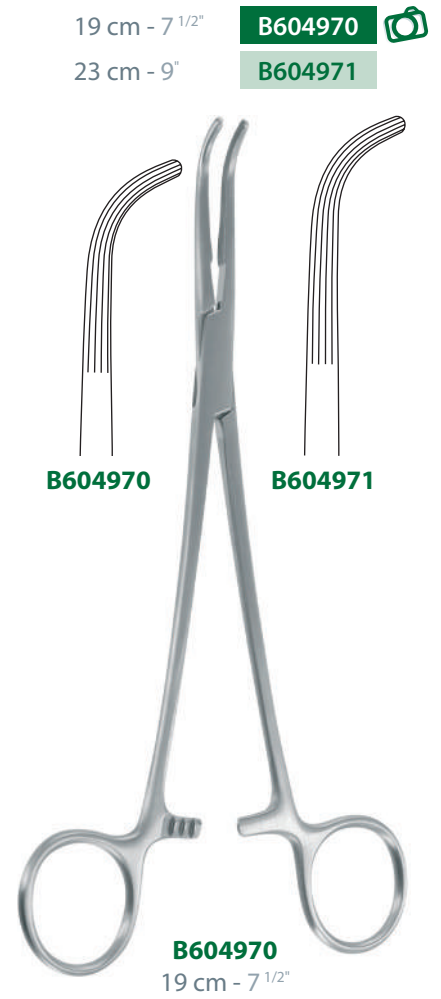

KANTROWITZ

19 cm - 7 1/2"

B607570 

24 cm - 9 1/2"

B607571

26,5 cm - 10 1/2"

B607569

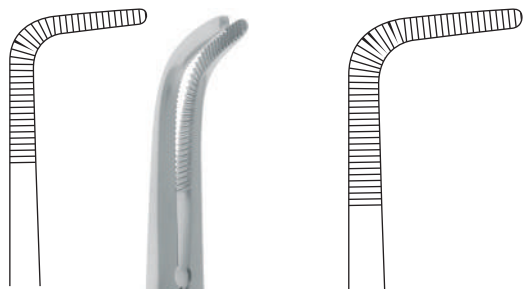

B607571

24 cm - 9 1/2"

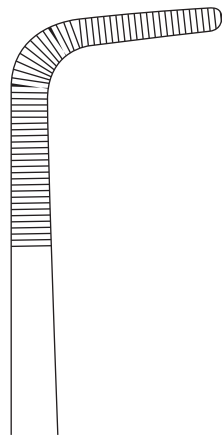

B607569

26.5 cm - 10 1/2"

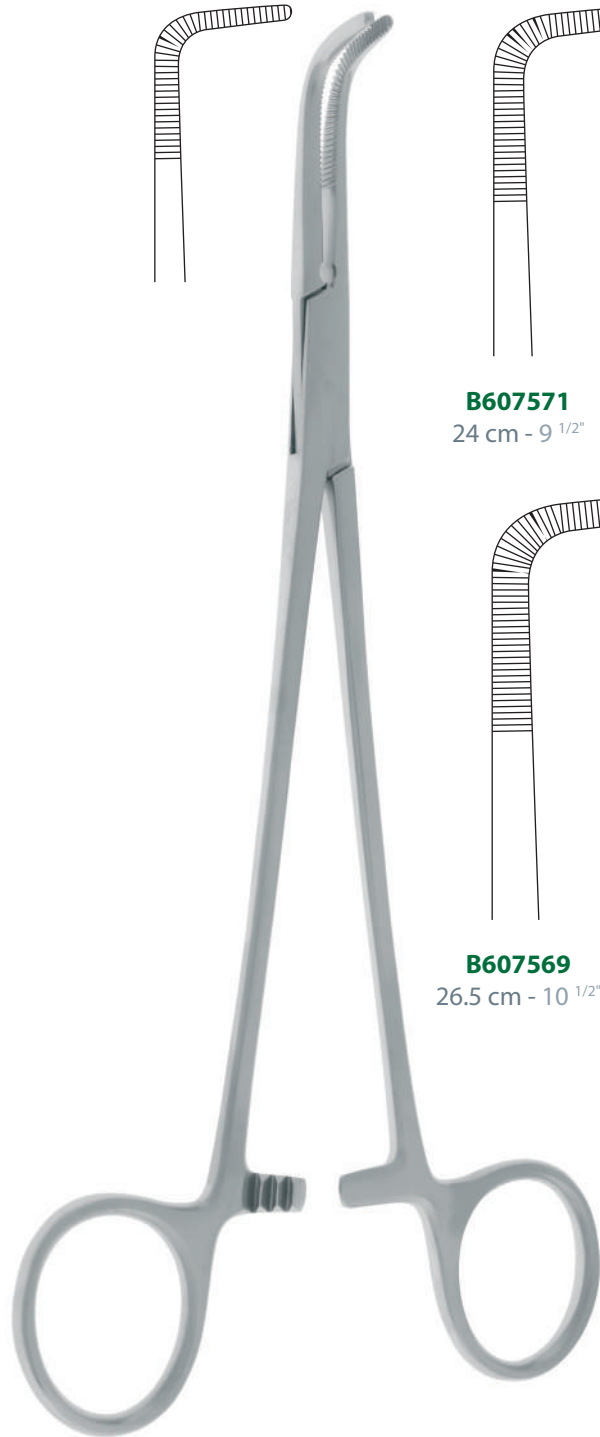

B607570
19 cm - 7 1/2"

OVERHOLT-MIXTER



B605009
22 cm - 8 3/4"

IV - Pinces
IV - Forceps
IV - Pinzas

QUILICY FARISSE

Sans crémaillère - Without ratchet - Sin cramallera

20 cm - 8"	B613000 
22 cm - 8 1/2"	B613020
24 cm - 9 1/2"	B613040
28 cm - 11"	B613080
30 cm - 11 3/4"	B613100

Avec crémaillère - With ratchet - Con cramallera

24 cm - 9 1/2"	B613041
----------------	----------------

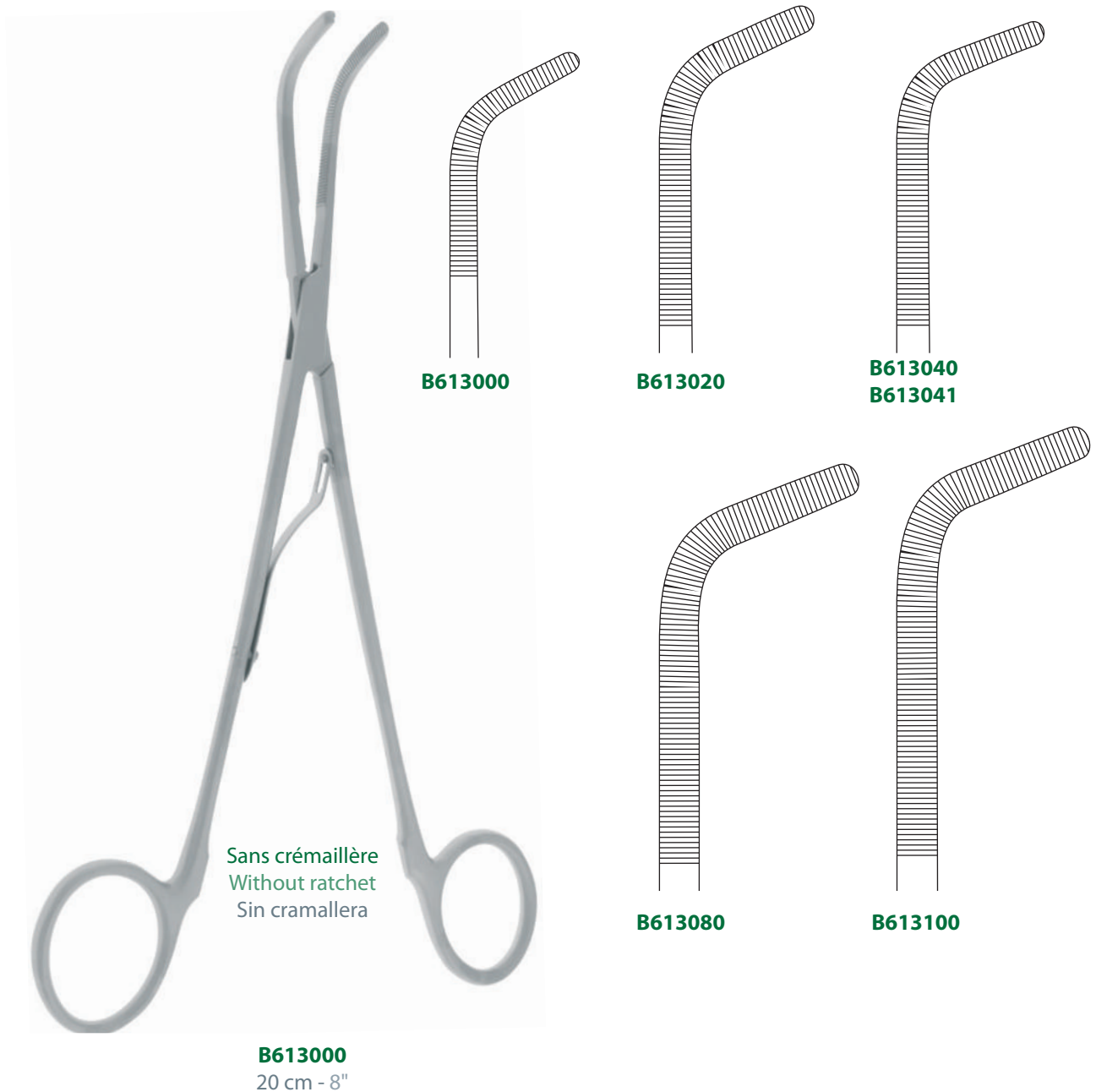

LANDANGER

Pinces passe-fils, dissecteurs - Ligature forceps, dissectors - Disecadores

RUMEL

MEEKER

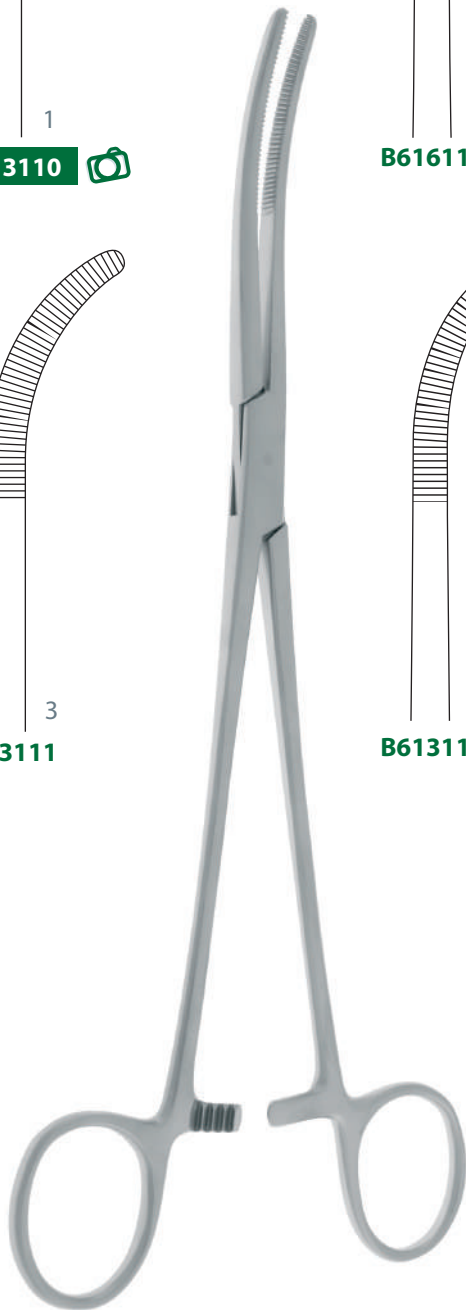
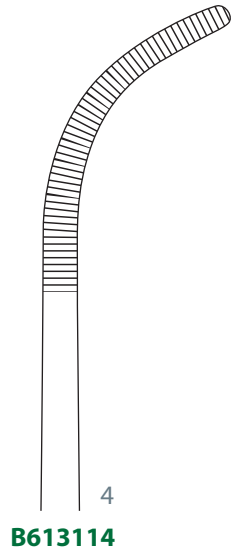
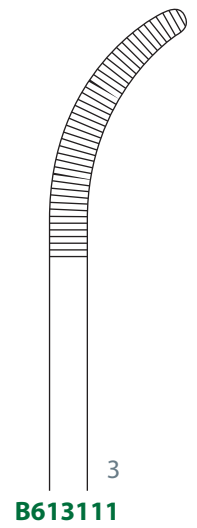
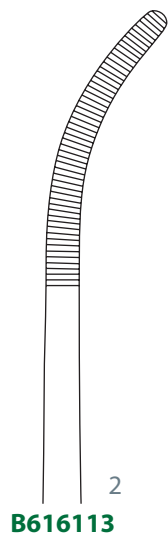
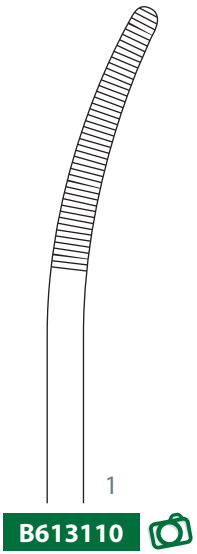

B613110
23 cm - 9"

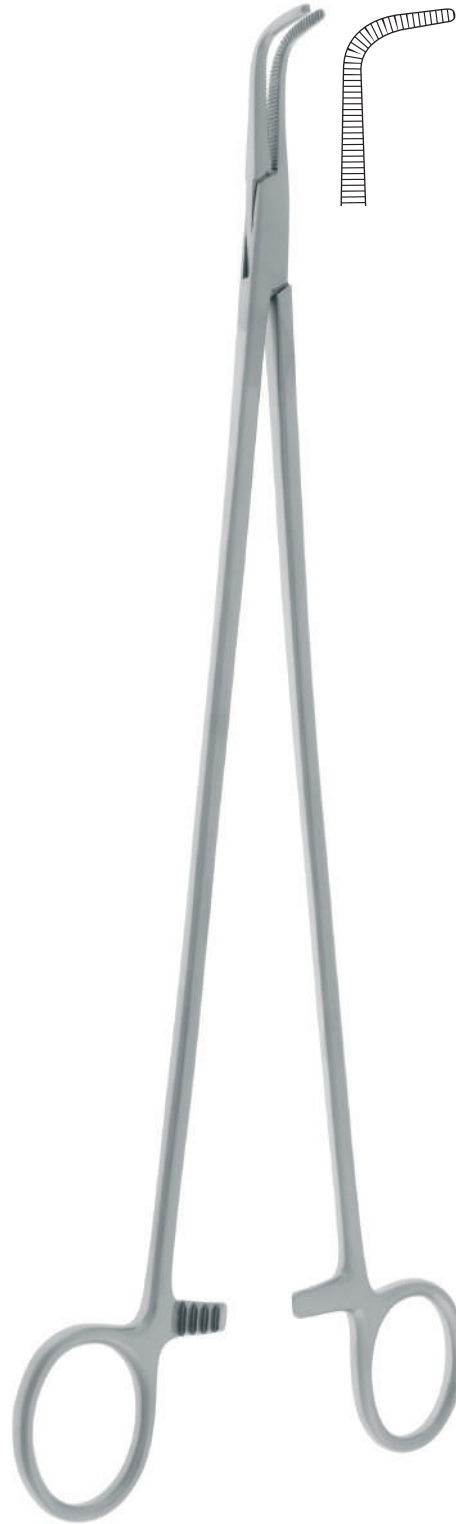
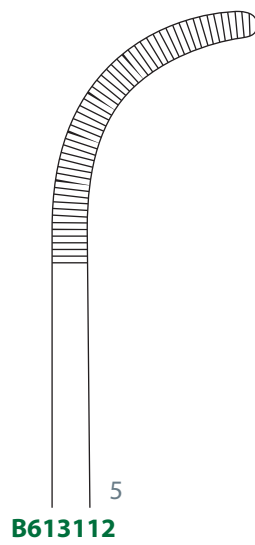

B613120
27 cm - 10^{1/2}"

IV - Pinces
IV - Forceps
IV - Pinzas

SEMB

SEMB-SAYLOR



B60810

22 cm - 8 ³/₄"

B60820

25 cm - 10"

BARRAYA



B60860
21 cm - 8 1/4"



B60870
21 cm - 8 1/4"



FINOCHIETTO

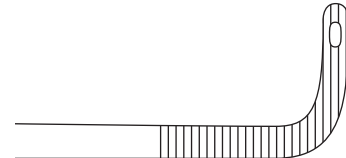
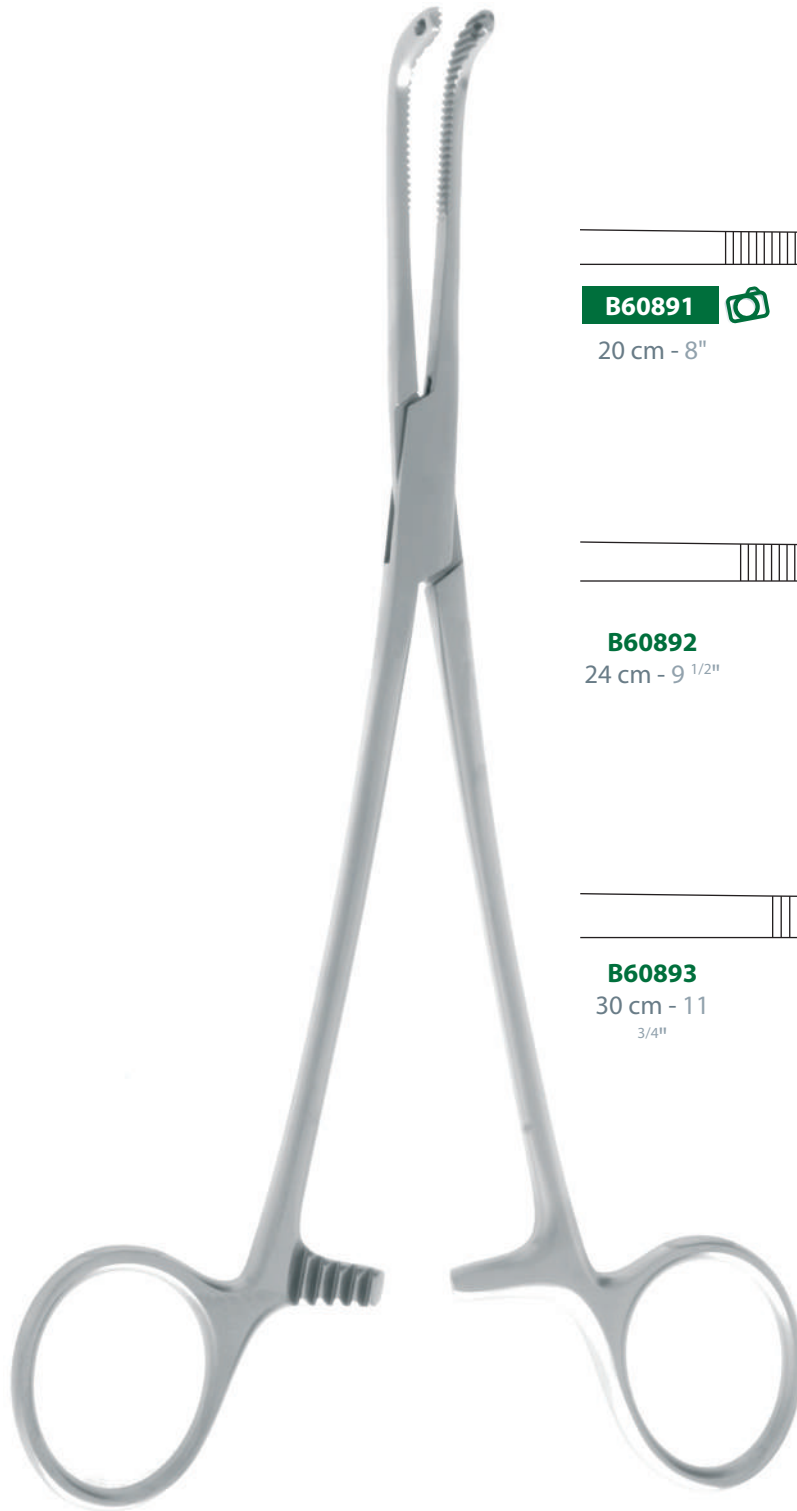

B60891 

20 cm - 8"

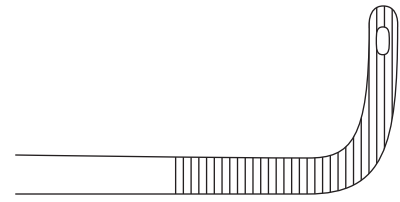

B60892

24 cm - 9 1/2"

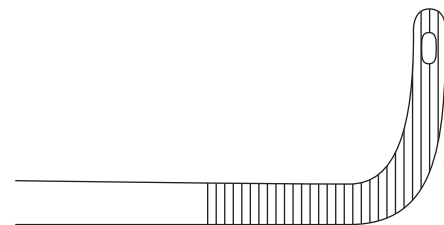

B60893

30 cm - 11 3/4"

B60891
20 cm - 8"

IV - Pinces
IV - Forceps
IV - Pinzas

HARRINGTON

31 cm - 12 1/4"

B607572

30,5 cm - 12"

B607574



B607572

Coudée, mors courts forts
Angular, short heavy jaws
Angulada, corto fuerte bocas

B607574

Coudée, mors long
Angular, long jaws
Angulada, bocas largas

B607574
30,5 cm - 12"

RESANO

Coudée
Angular
Angulada



Double courbure
Double bend
Doble curvatura

B640000
30 cm - 11 3/4"

QUENU

HARTMANN



 B650900

B651000

 B65070

B65080

B650900
15 cm - 6"

B65070
19 cm - 7 1/2"

DOYEN

NEGUS

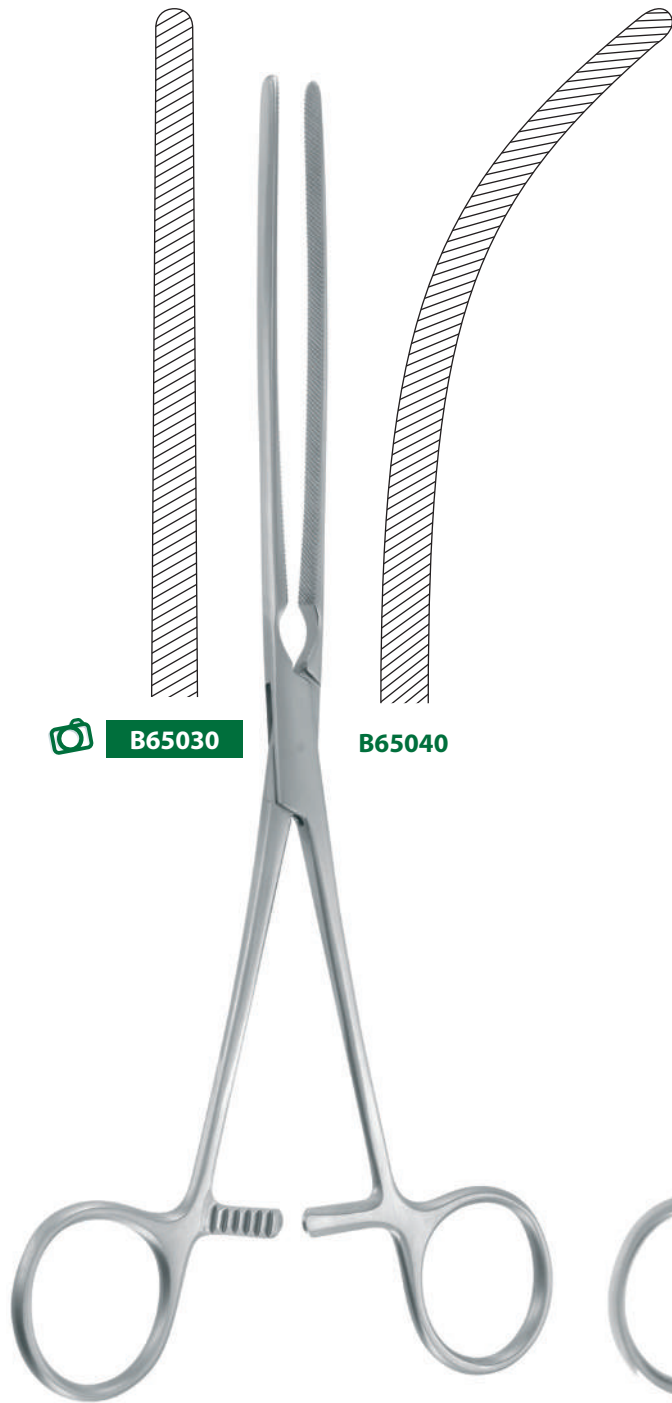

 **B65030**

B65040

B60897 
21 cm - 8 1/4"

B60896
19 cm - 7 1/2"

B65030
23 cm - 9"

B60897
21 cm - 8 1/4"

BABY-DOYEN

Droite
Straight
Recta

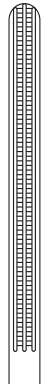

C10855
13 cm - 5"

Courbe
Curved
Curva

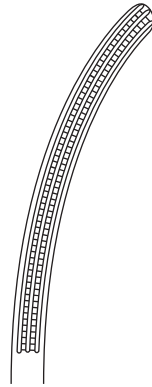

C10860

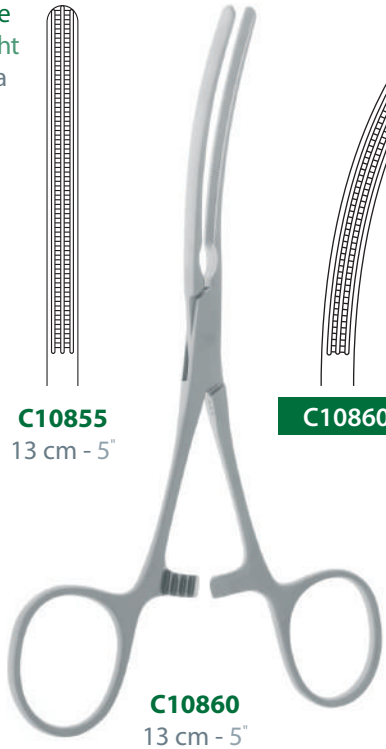

C10860
13 cm - 5"

Mors non traumatisants
Non-traumatic jaws
Boca no traumática

SCHEIBE

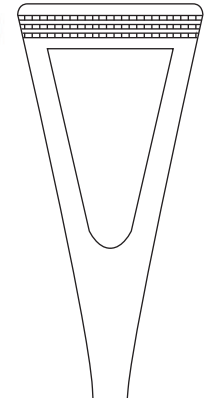

24 mm



C10850
23 cm - 9"

BABY KOCHER

Droite
Straight
Recta



C108540

Courbe
Curved
Curva

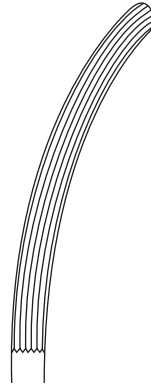

C108545
13 cm - 5"

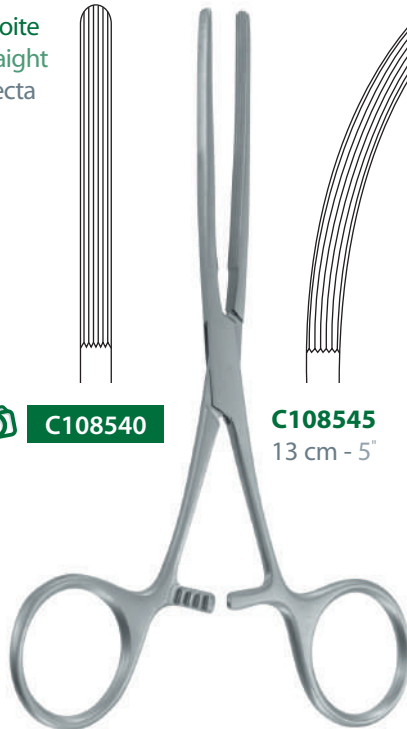

C108540
13 cm - 5"

MAYO ROBSON

	Droite Straight Recta		Courbe Curved Curva
	C108990	21 cm - 8 1/4"	C108995
	C108991	23 cm - 9"	C108996
	C108992	25 cm - 10"	C108997
Mors non traumatisants - Non-traumatic jaws - Boca no traumática			
	C10900	25 cm - 10"	C10905

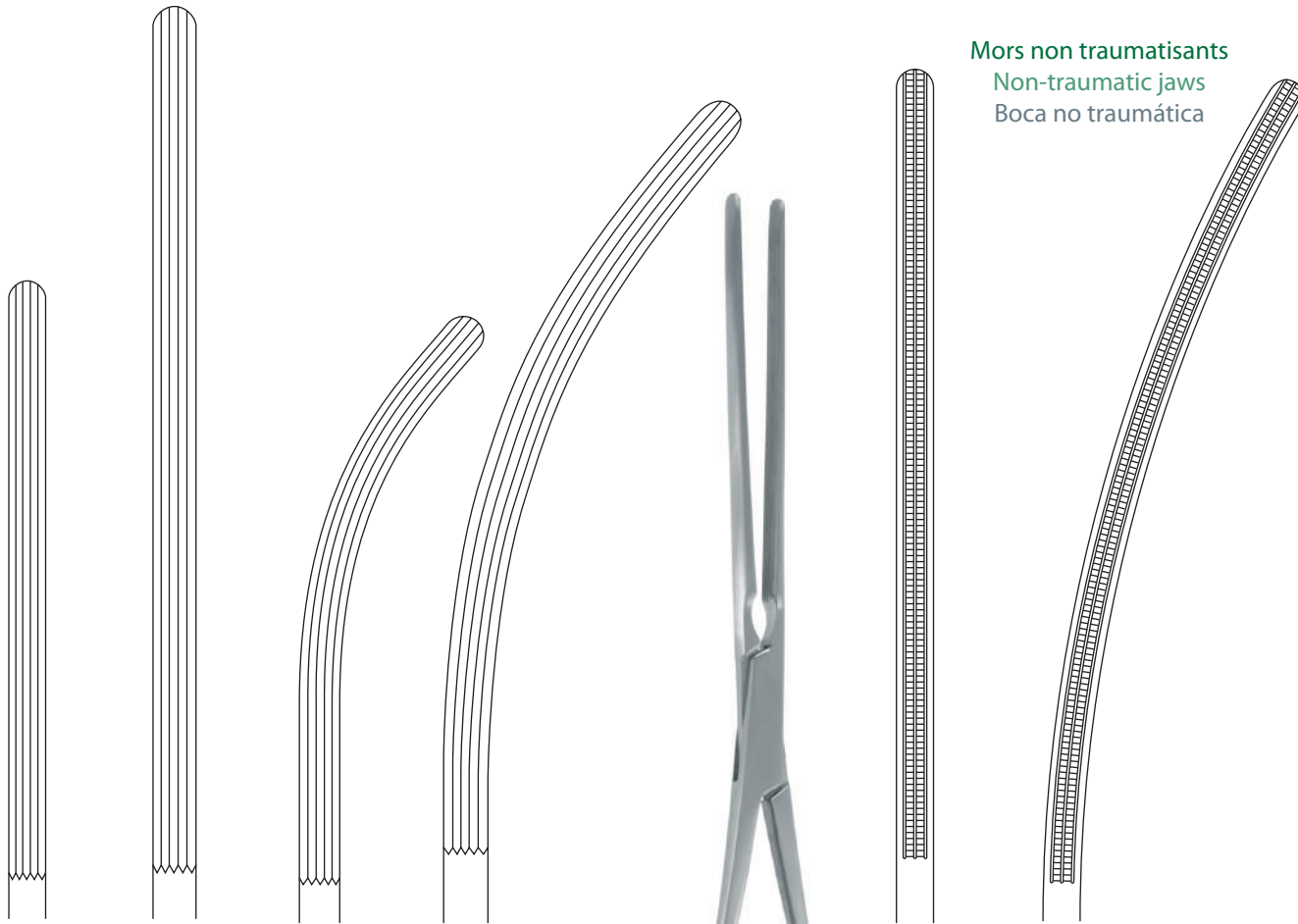

Mors non traumatisants
Non-traumatic jaws
Boca no traumática

C108990
21 cm - 8 1/4"

C108992
25 cm - 10"

C108995
21 cm - 8 1/4"

C108997
25 cm - 10"

C10900
25 cm - 10"

C10905
25 cm - 10"

C108991
23 cm - 9"

C108996
23 cm - 9"

C108990
21 cm - 8 1/4"

IV - Pinces
IV - Forceps
IV - Pinzas

DOYEN

Droite
Straight
Recta



Mors non traumatisants
Non-traumatic jaws
Boca no traumática

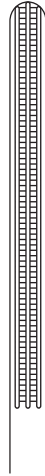

C10865
18 cm - 7"

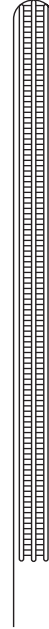

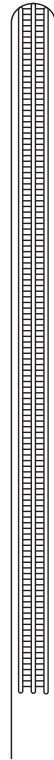

 **C10870**
21 cm - 8 1/4"

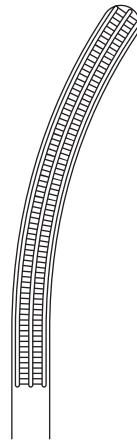

C10875
23 cm - 9"

Courbe
Curved
Curva



 **C10880**
18 cm - 7"

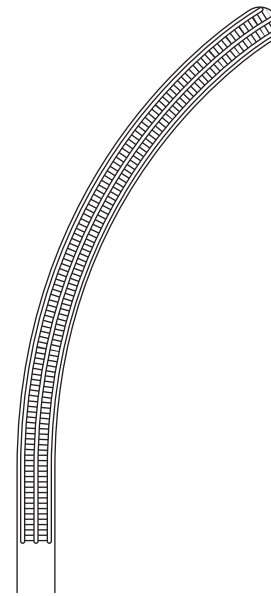

C10890
21 cm - 8 1/4"

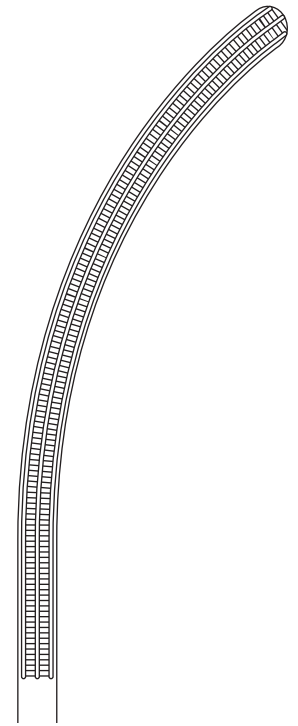

C10895
23 cm - 9"

KOCHER

Droite
Straight
Recta

Courbe
Curved
Curva



C109090

22 cm - 8 ³/₄"



C109095

C109091

25 cm - 10"

C109096

C109092

28 cm - 11"

C109097



C109092



C109091



C109090

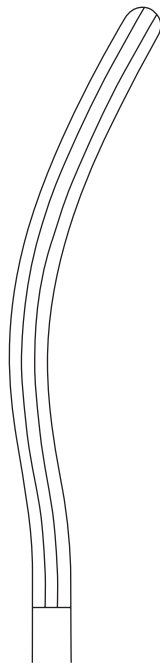

C109095

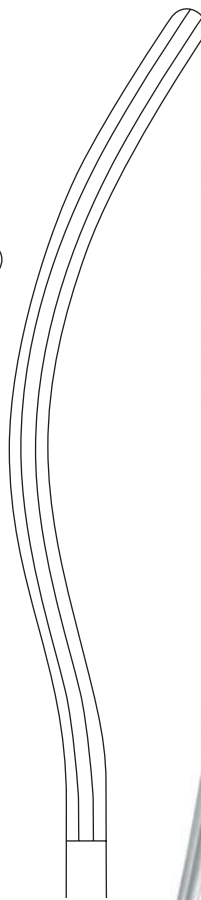

C109096

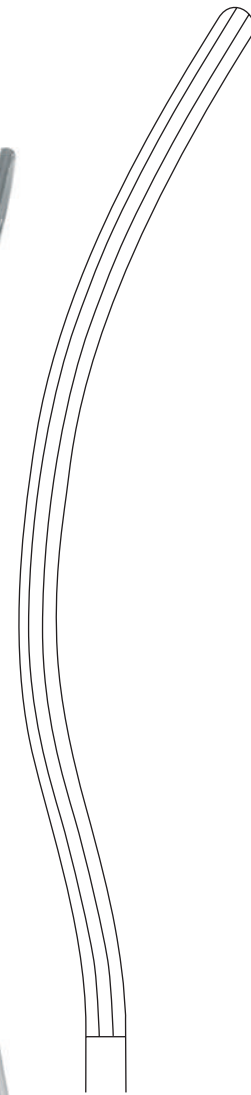

C109097

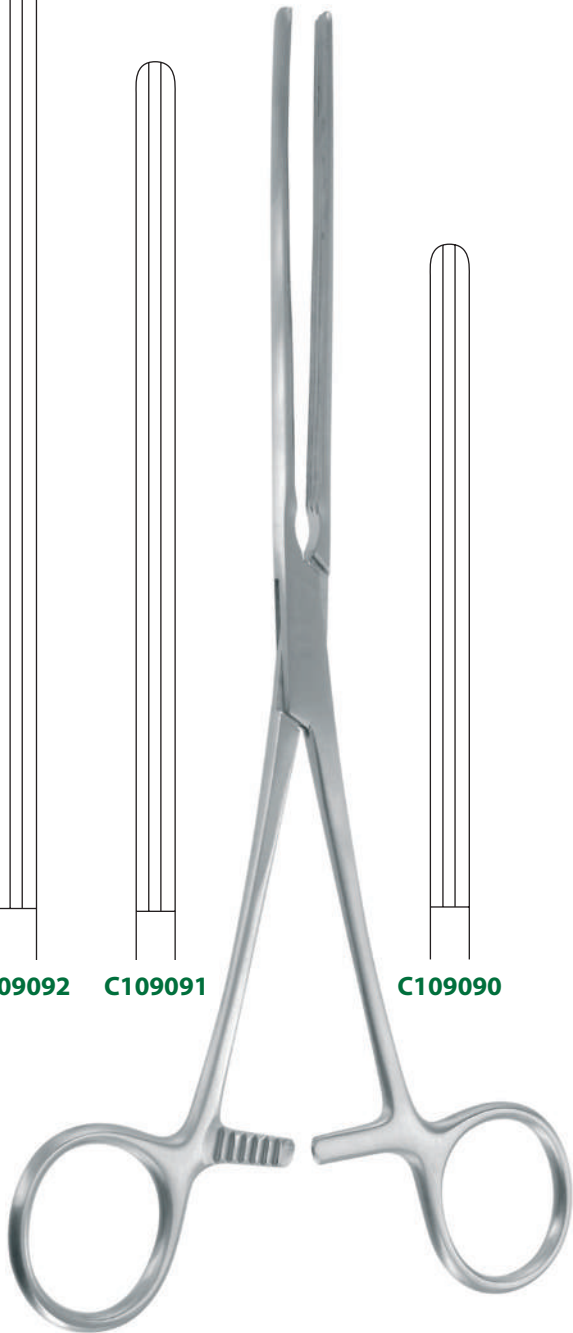

C109090
22 cm - 8 ³/₄"

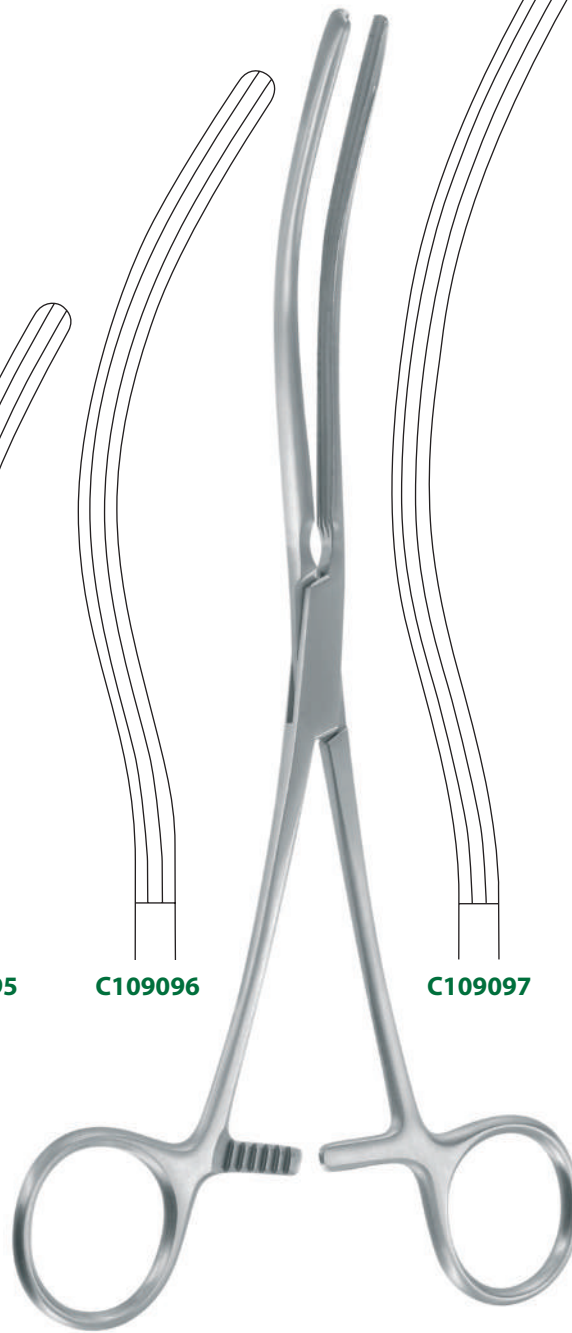

C109095
22 cm - 8 ³/₄"

KOCHER

Mors non traumatisants - Non-traumatic jaws - Boca no traumática

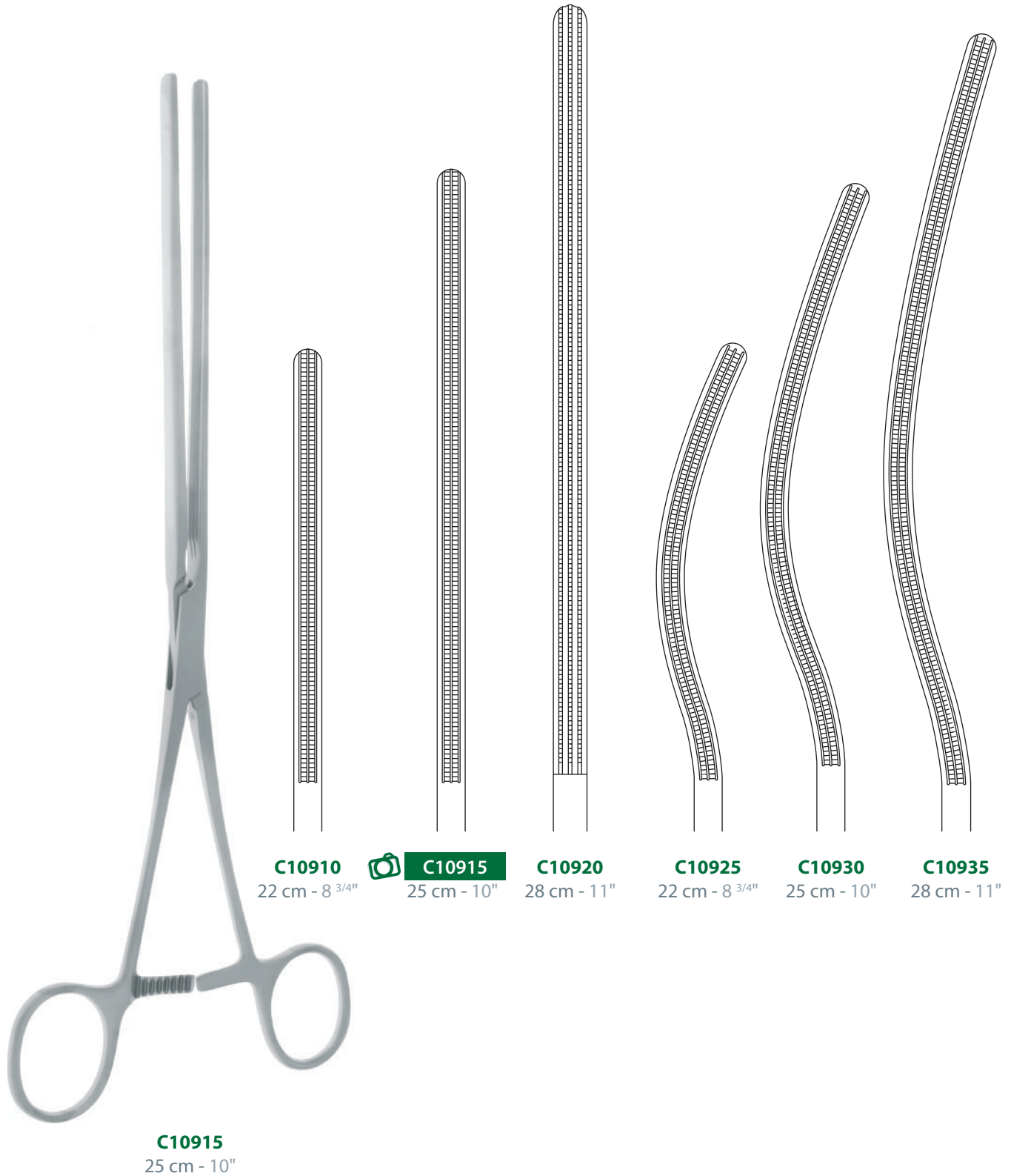

IV - Pinces
IV - Forceps
IV - Pinzas

C10910
22 cm - 8 3/4"

 **C10915**
25 cm - 10"

C10920
28 cm - 11"

C10925
22 cm - 8 3/4"

C10930
25 cm - 10"

C10935
28 cm - 11"

C10915
25 cm - 10"

PAYR

Pour enfant
For children
Para niños



BABY

C109500

15 cm - 5 3/4"



C109501

21 cm - 8 1/4"



C109502

29 cm - 11 1/2"



C109503

35 cm - 13 3/4"

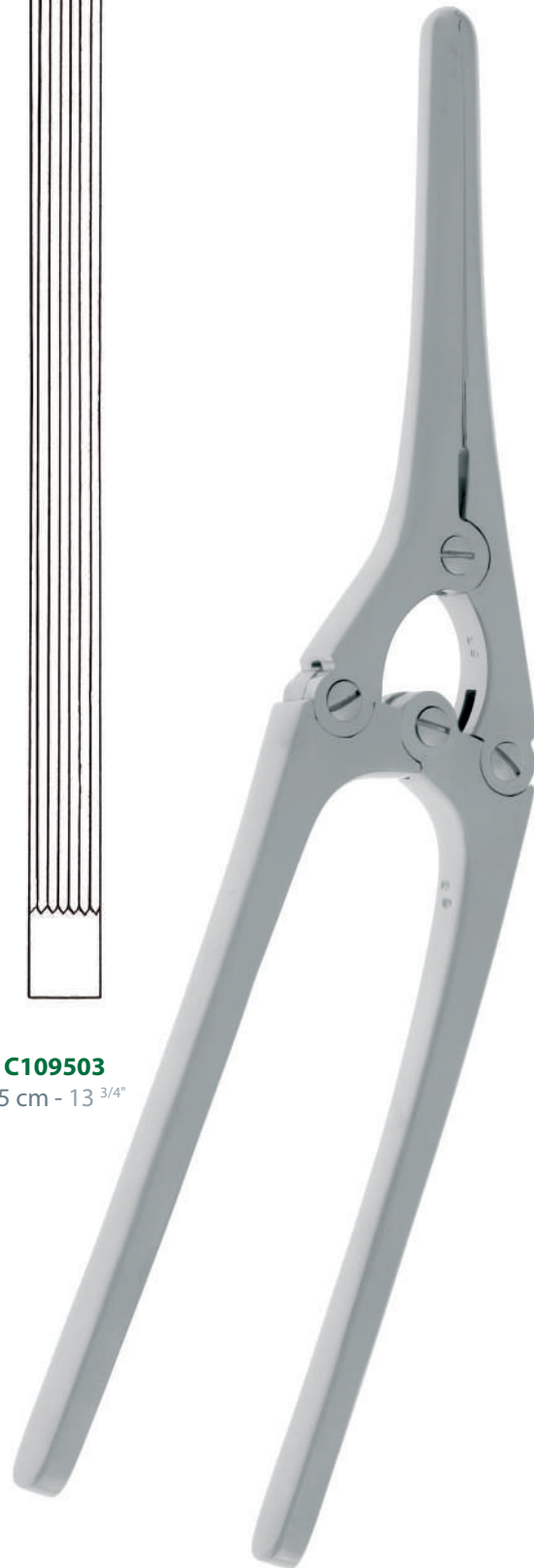

C109501

21 cm - 8 1/4"

IV - Pinces
IV - Forceps
IV - Pinzas

BRUNNER

23 cm - 9 1/4"

C109461



24 cm - 9 1/2"

C109460

Mors non traumatisants
Non-traumatic jaws
Boca no traumática

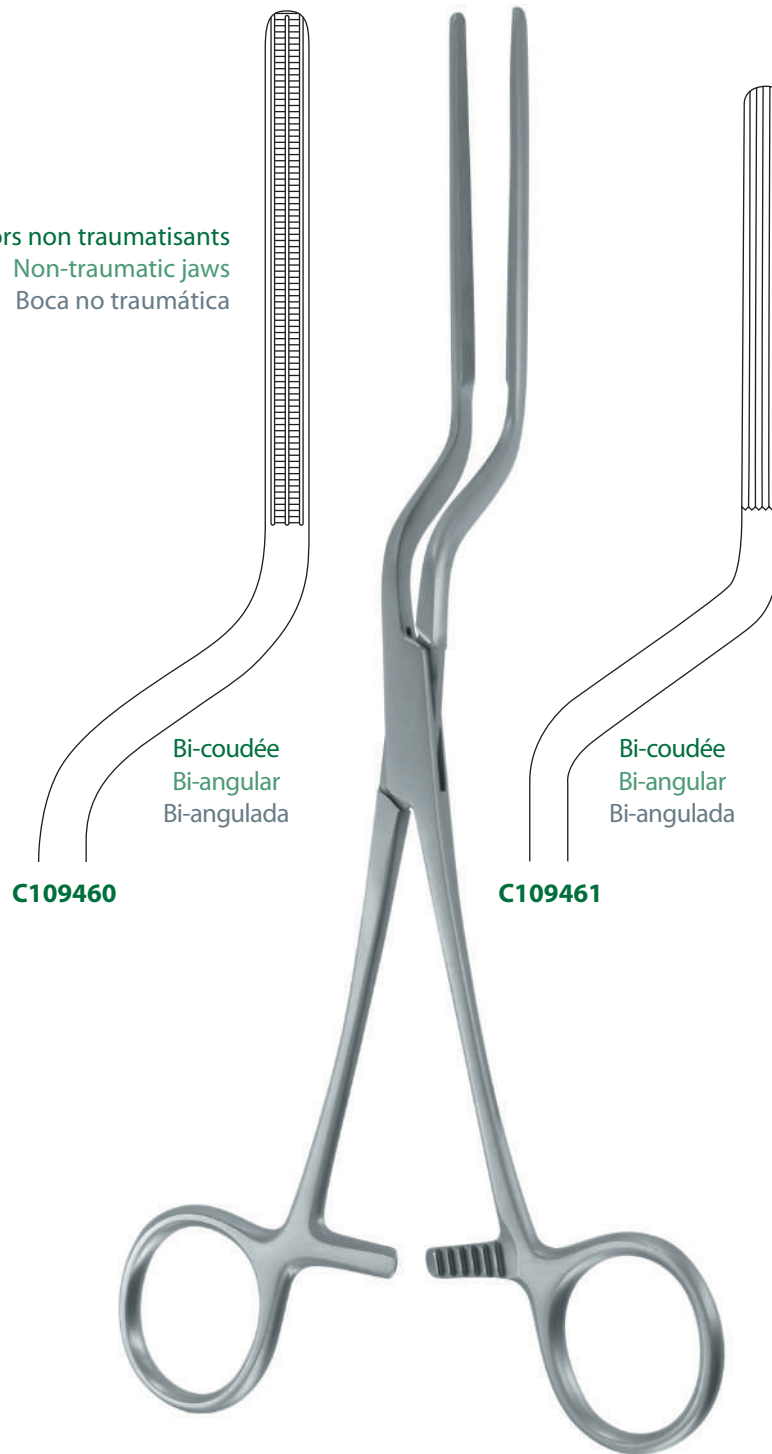

C109460

C109461

C109461

23 cm - 9 1/4"

ALLEN

15,5 cm - 6"

C108530



20,5 cm - 8"

C108531

A griffes
With teeth
Con dientes

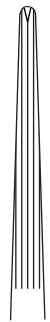

C108530

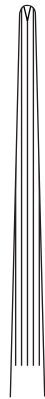

C108531



C108530
15,5 cm - 6"

KLEINSCHMIDT

Pince pour l'appendice
Blind gut forceps
Pinza para apendice

Coudée à griffes
Angular with teeth
Angulada con dientes

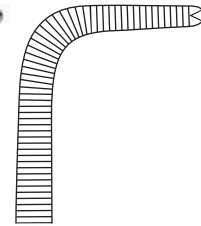

B641000
12 cm - 4^{3/4}"

SCUDDER

NUSSBAUM

Mors non traumatisants - Non-traumatic jaws - Boca no traumática

Droite
Straight
Recta

Courbe
Curved
Curva

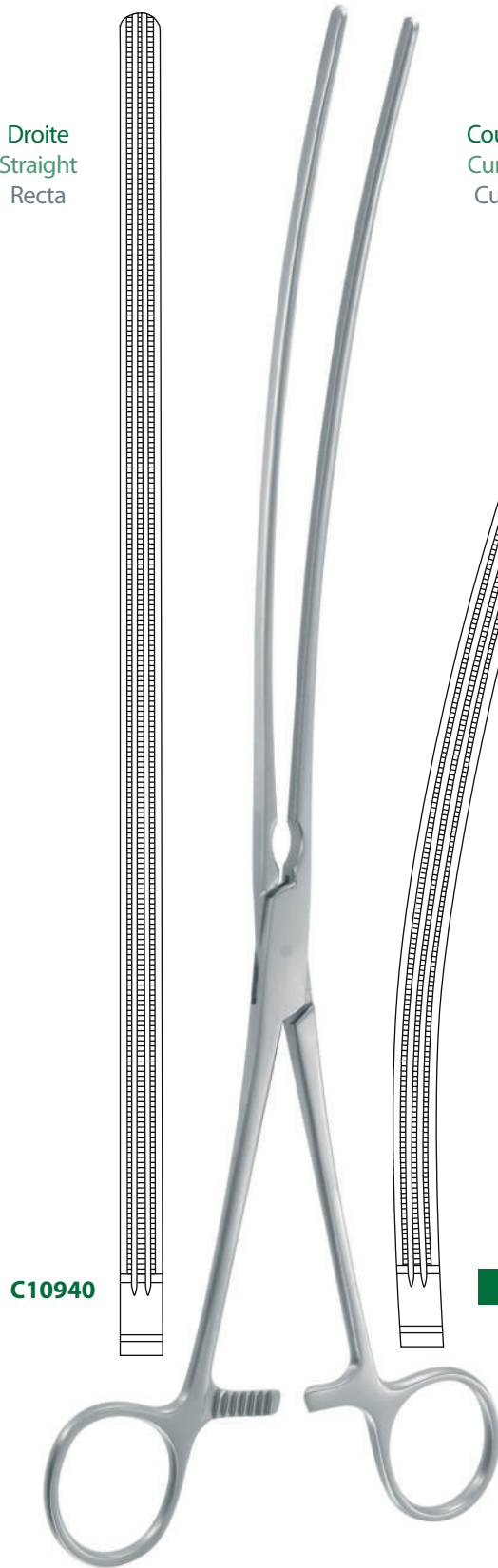

C10940

C10945

C10945
33 cm - 13"

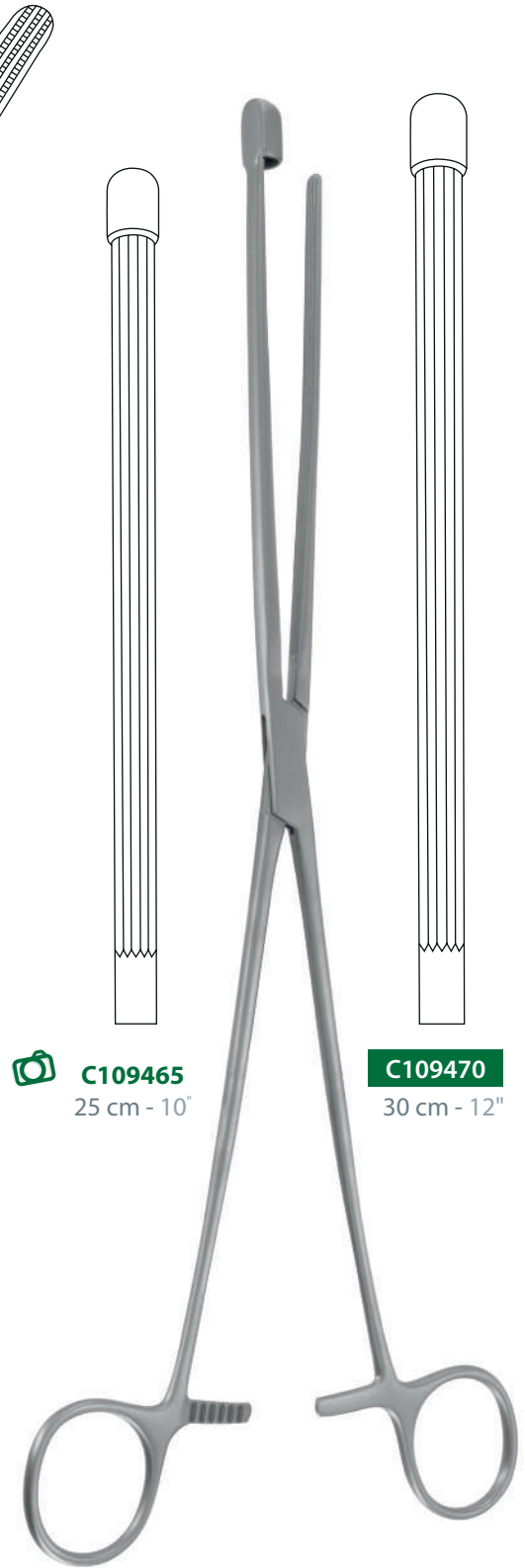

C10946
25 cm - 10"

C10947

30 cm - 12"

C10947
30 cm - 12"



LANE

Pinces clamps jumelées - Twin clamp forceps - Pinzas clamps gemelas

Droite
Straight
Recta

Courbe
Curved
Curva

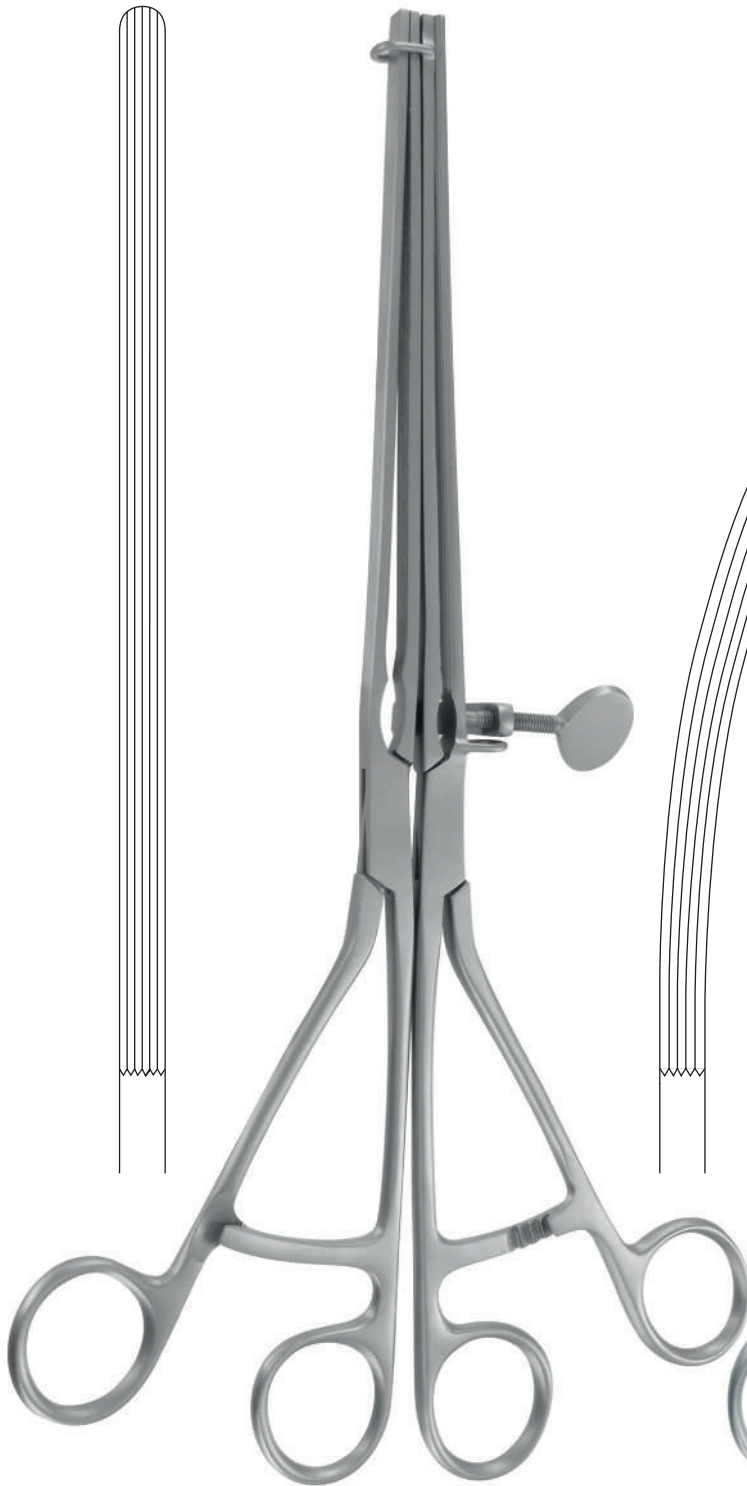

C109480
30 cm - 12"

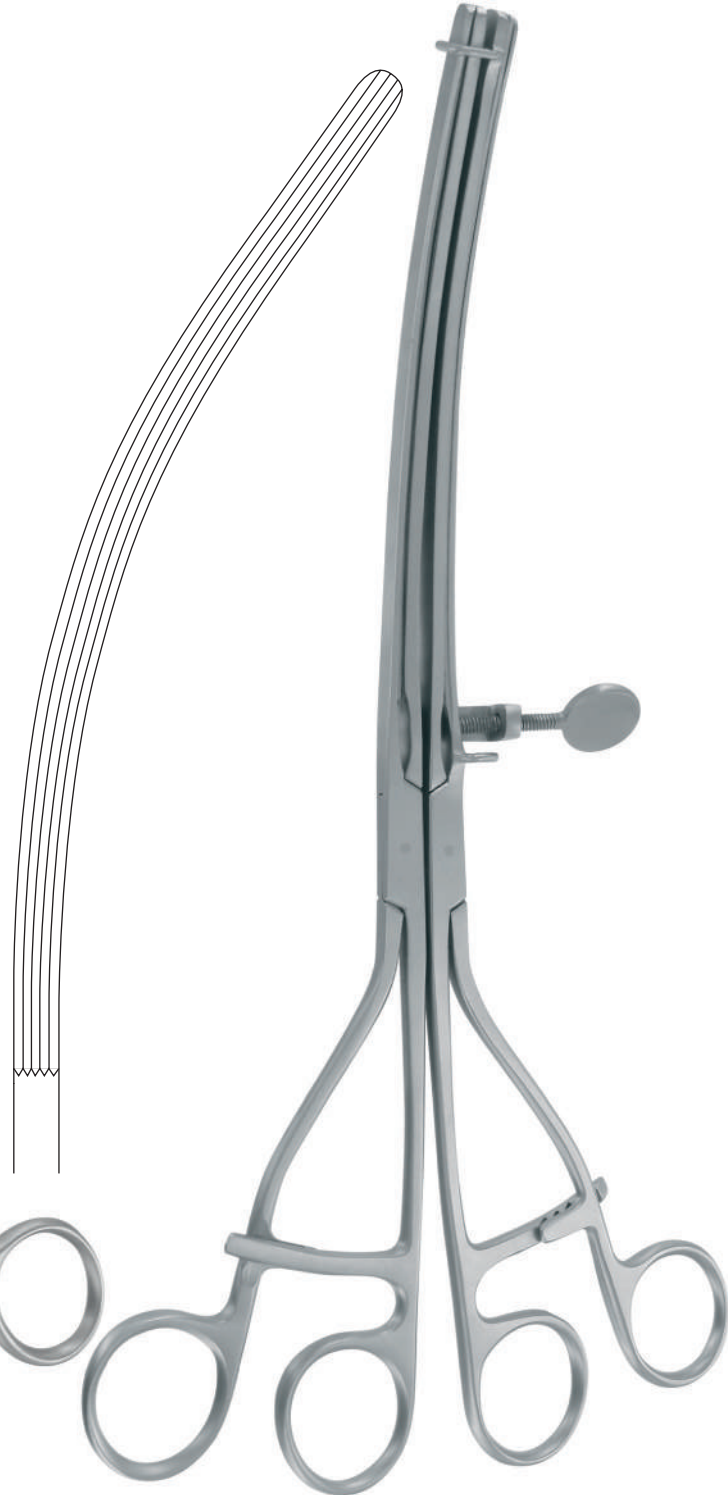

C109485
30 cm - 12"

DE MARTEL - WOLFSON

Pince pour fermer les clamps
Clamp closing forceps
Pinzas para cerrar clamps

Porte clamps
Clamp holder
Porta clamps



B641115
23 cm - 9"



B641110
8,5 cm - 3 1/2"

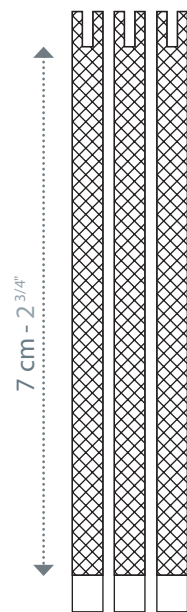

7 cm - 2 3/4"

B641100

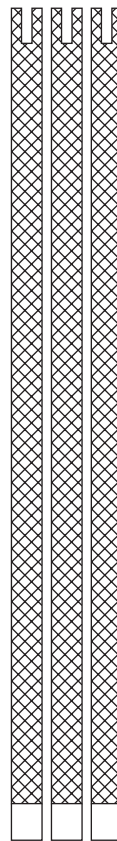

B641105

Jeu de 3 clamps
Set of 3 clamps
Juego de 3 clamps

7 cm - 2 3/4"

B641100 

10 cm - 4"

B641105



B641120
26,5 cm - 10 1/2"

PRICE THOMAS

Pinces clamps à bronches
Bronchus clamps
Pinzas clamps para bronquios



B60885
22 cm - 8 ³/₄"



Sans griffes
Without teeth
Sin dientes

B60880



Griffes à droite
Teeth on the right
Dientes a la derecha

B60885



Griffes à gauche
Teeth on the left
Dientes a la izquierda

B60890

BABY SATINSKY



B640020
15 cm - 6"

SATINSKY

Branches droites
Straight branches
Ramas rectas

- N° 1  **B640009**
- N° 2 **B640010**

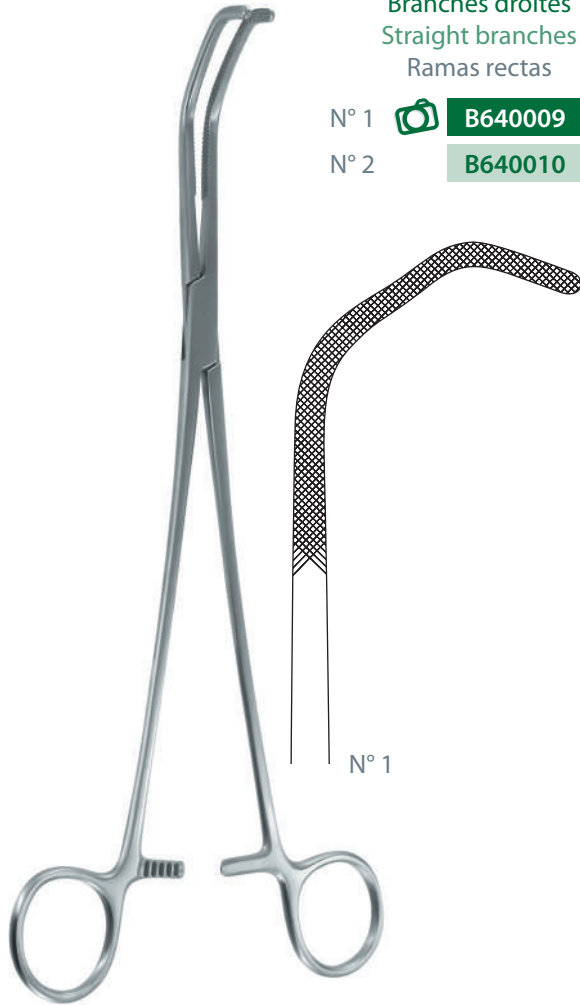

B640009
26,5 cm - 10 1/2"

Branches courbes
Curved branches
Ramas curvas

- N° 1 **B640015**
- N° 2 **B640016** 

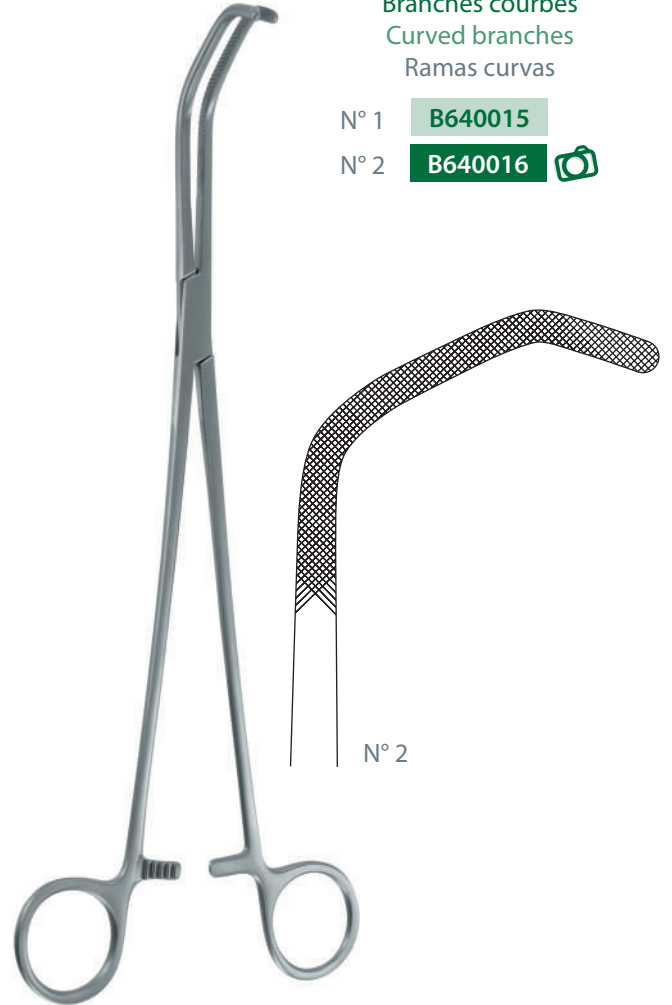

B640016
26,5 cm - 10 1/2"

HARKEN



B640032
24 cm - 9 1/2"

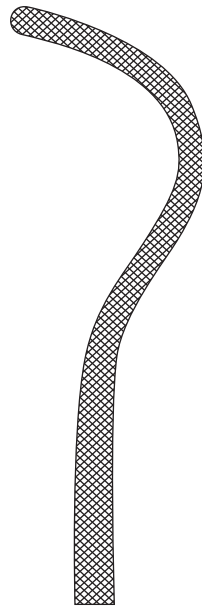

B640031

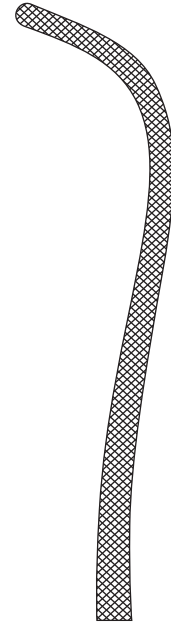

 **B640032**

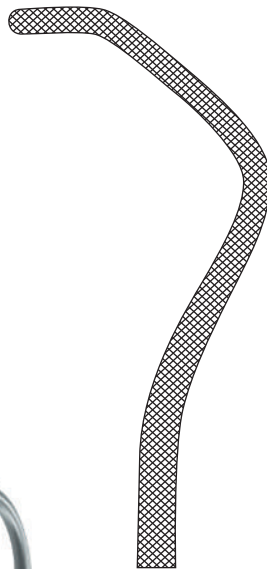

B640033

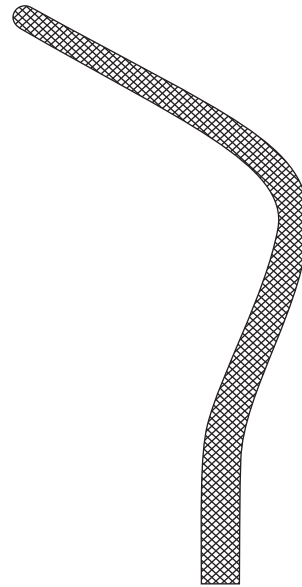

B640034

DE MARTEL (PITANGUY)

Pince pour le cuir chevelu - Scalp flap forceps - Pinza para pericraneo

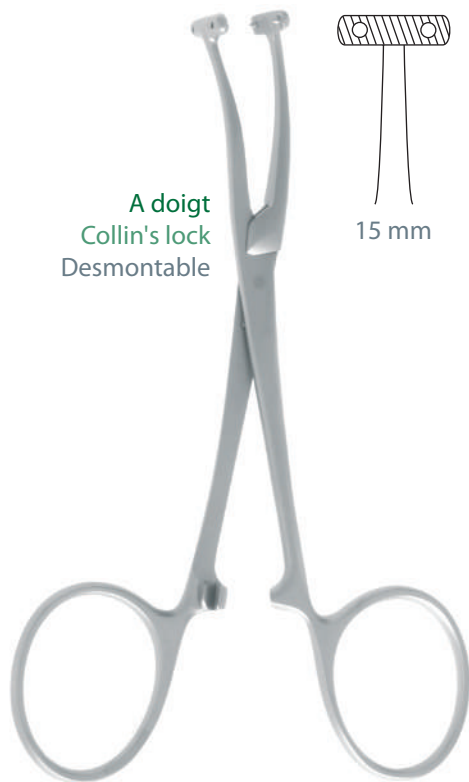

A doigt
Collin's lock
Desmontable

15 mm

B65135
13 cm - 5"

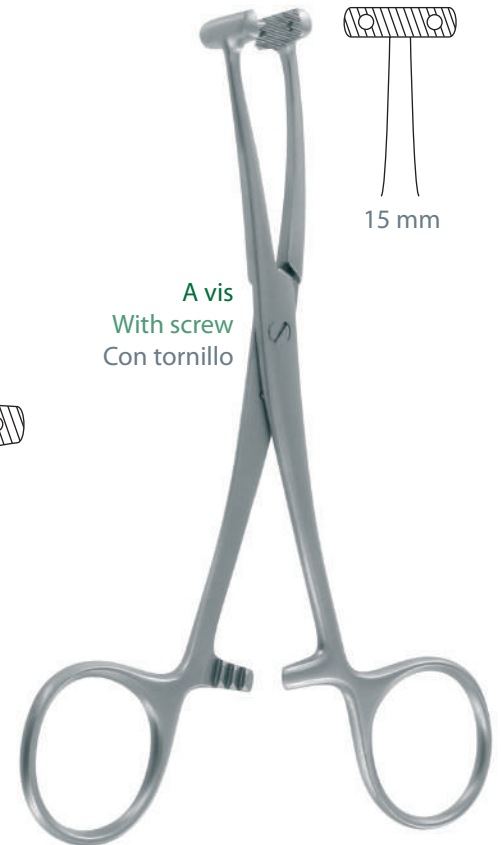

A vis
With screw
Con tornillo

15 mm

B651350
14 cm - 5 1/2"



18 mm

B651360
19 cm - 7 1/2"

En coeur - Heart-shaped - Figura de corazon



B65119
16 cm - 6 1/4"

A doigt
Collin's lock
Desmontable
B65113
16 cm - 6 1/4"

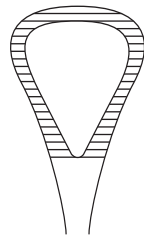

18 mm

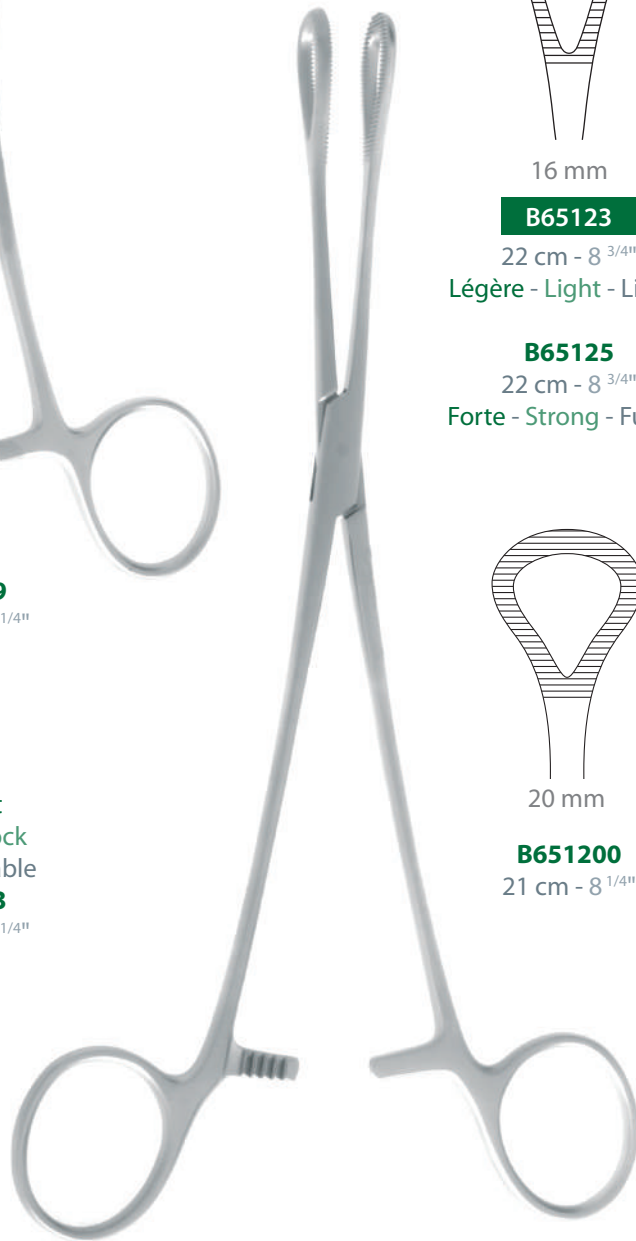

B65123
22 cm - 8 3/4"

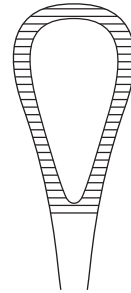

16 mm

B65123

22 cm - 8 3/4"

Légère - Light - Ligera

B65125

22 cm - 8 3/4"

Forte - Strong - Fuerte

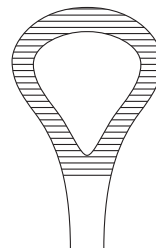

20 mm

B651200

21 cm - 8 1/4"

Atraumatique
Non-traumatic
No traumática

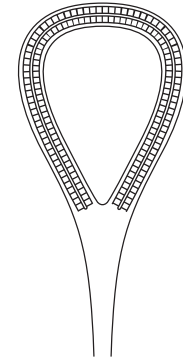

22 mm

B65126

25 cm - 10"

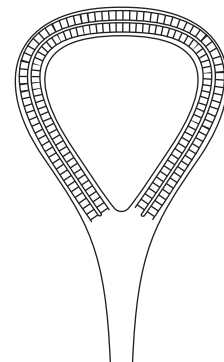

28 mm

B651265

27 cm - 10 3/5"

WALTER-DUVAL

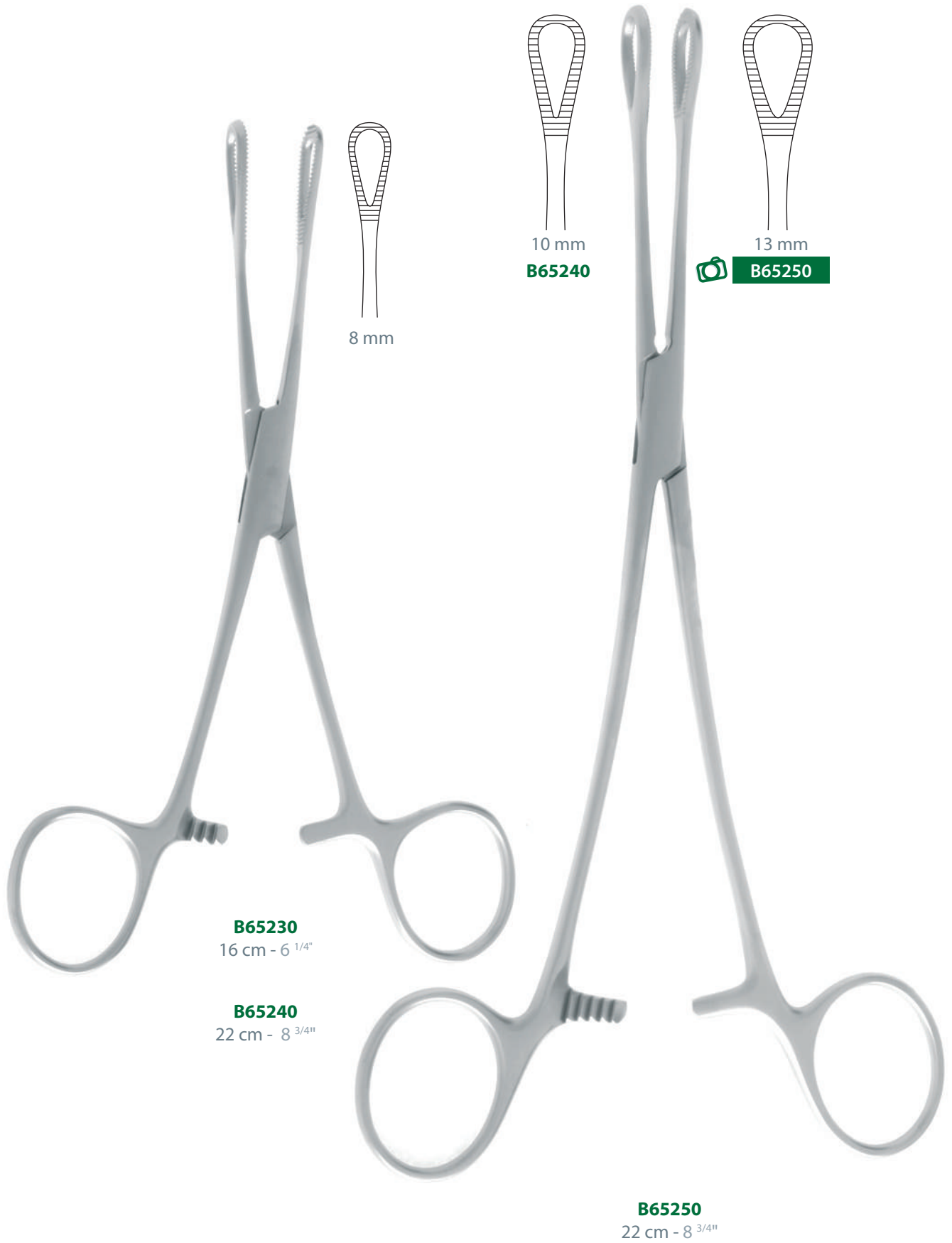

B65230
16 cm - 6 1/4"

B65240
22 cm - 8 3/4"

B65250
22 cm - 8 3/4"

IV - Pinces
IV - Forceps
IV - Pinzas

COLLIN

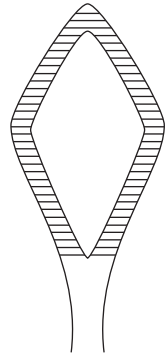

Losange
Diamond
Rombo



B65127

16 cm - 6 1/4"

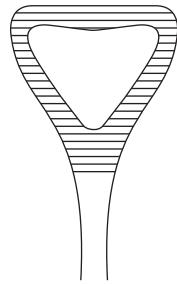

Triangle
Triangular
Triángulo

B65129

16 cm - 6 1/4"

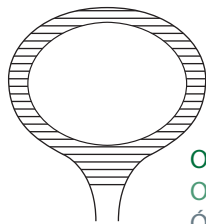

Ovale
Oval
Óvalo

B65131

16 cm - 6 1/4"

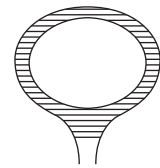

B651315

16 cm - 6 1/4"

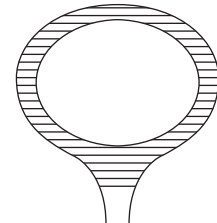

B651320

16,5 cm - 6 1/2"

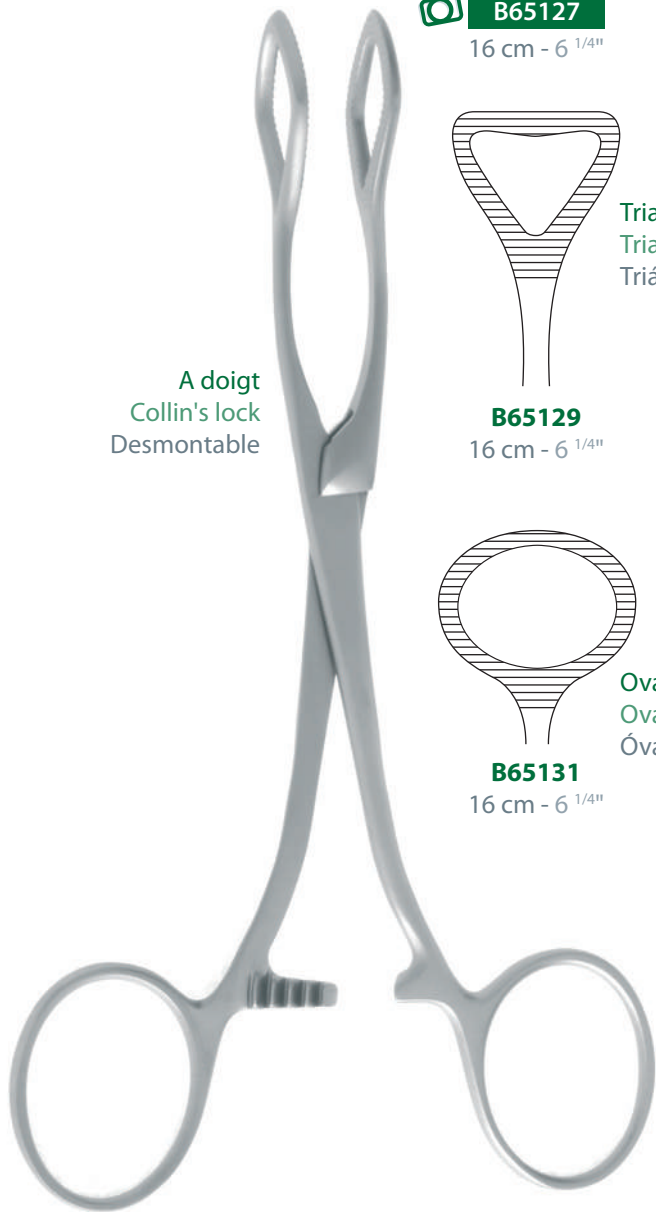

A doigt
Collin's lock
Desmontable

B65127

16 cm - 6 1/4"



B651315

16 cm - 6 1/4"



GREGOIRE



IV - Pinces
IV - Forceps
IV - Pinzas

Pinces à préhension - Grasping forceps - Pinzas a prensión

DUVAL

Striures horizontales
Horizontal streaking
Estrizados horizontales

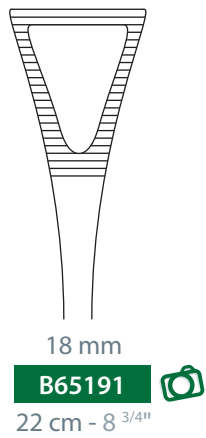
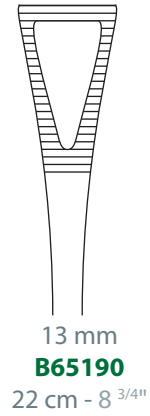

B65191
22 cm - 8 3/4"

PENNINGTON

15 cm - 6"
20 cm - 8"

B651500

B651550 

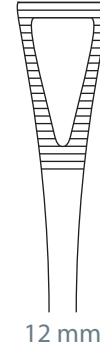

B651550
20 cm - 8"

IV - Pinces
IV - Forceps
IV - Pinzas

DUVAL

Dents pénétrantes - Penetrating teeth - Dientes penetrantes

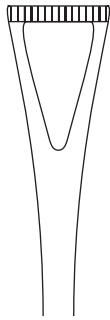

B65192
13 mm
22 cm - 8 ³/₄"

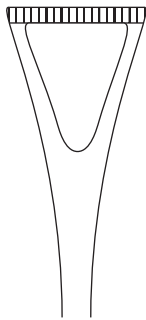

B65193 
18 mm
22 cm - 8 ³/₄"

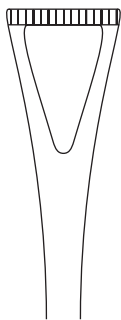

B651565
14 mm
18 cm - 7"

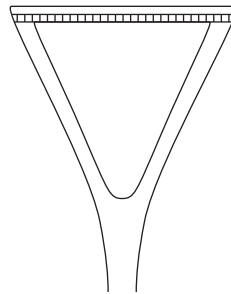

A doigt
Collin's lock
Desmontable

B65170
30 mm
20 cm - 8"

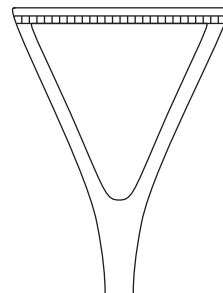

B651580
28 mm
21 cm - 8 ¹/₃"

LOCKWOOD



B651555
8 mm
20 cm - 8"

COLLIN

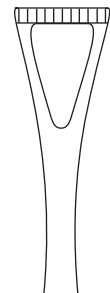

B651560
13 mm
14 cm - 5 ¹/₂"

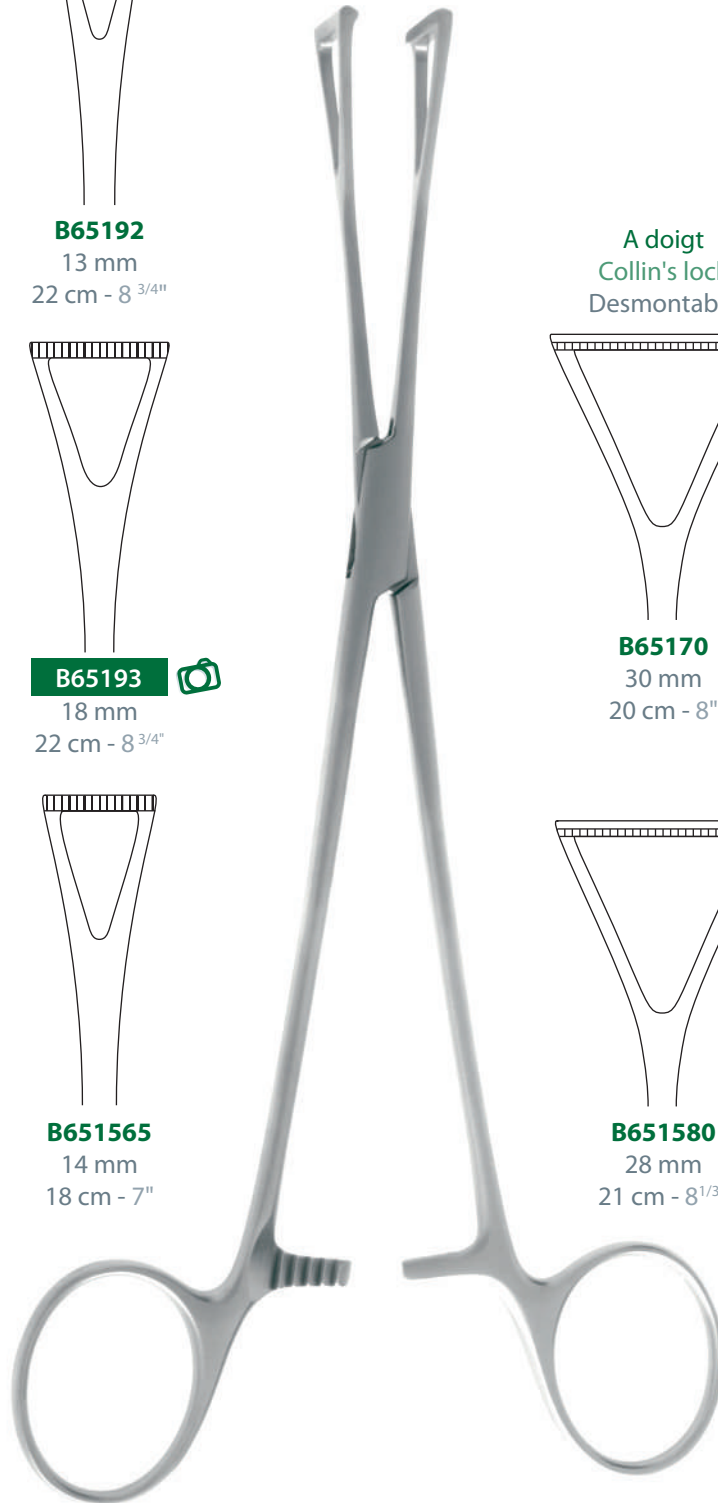

B65193
22 cm - 8 ³/₄"

DUVAL



Mors non traumatisants
Non-traumatic jaws
Bocas no traumáticas



B65210
20 cm - 8"

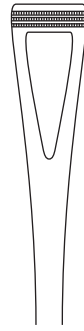
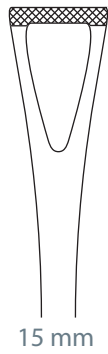

B652110
18 cm - 7"

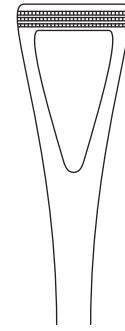

B65215 
20 cm - 8"

SCHEIBE

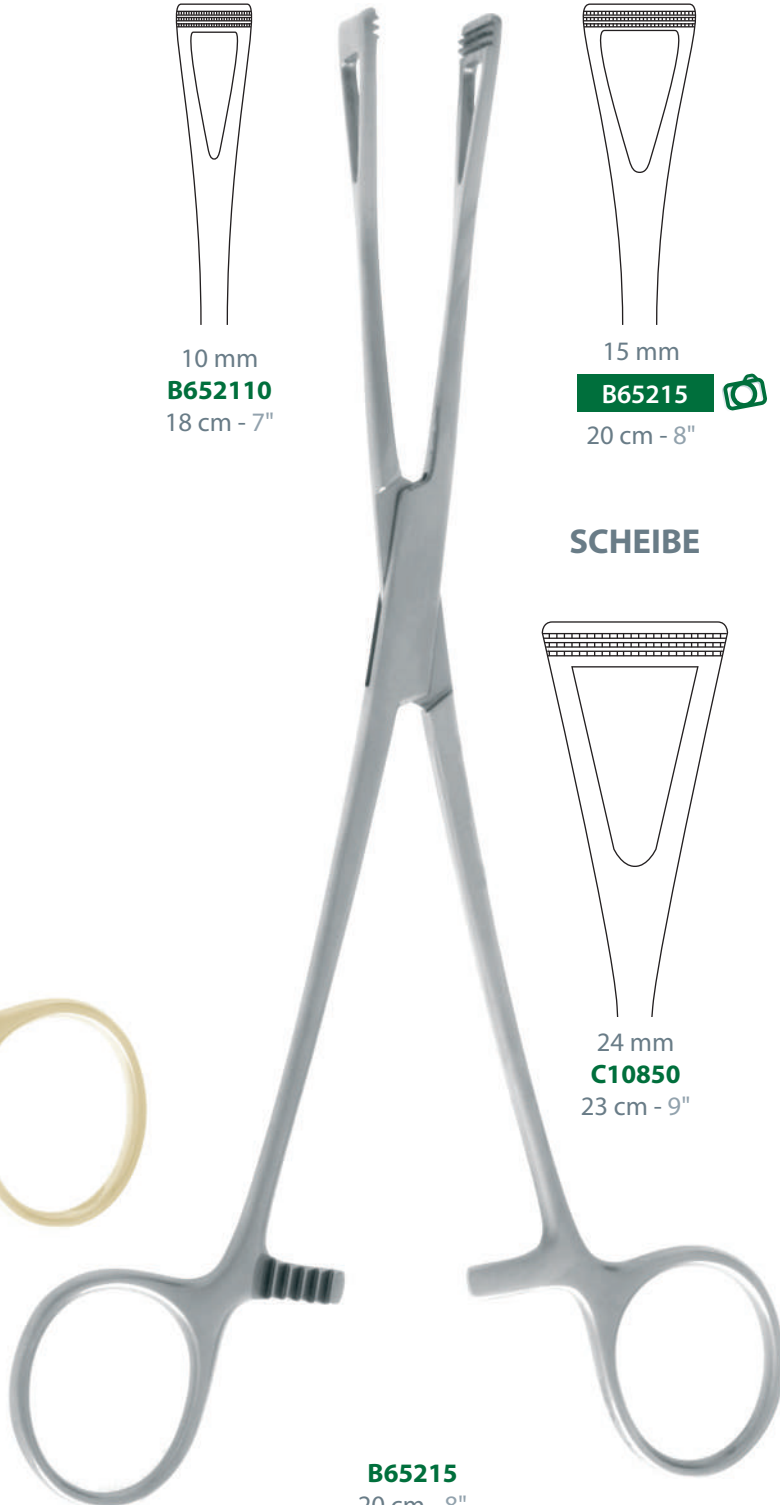

B65215
20 cm - 8"

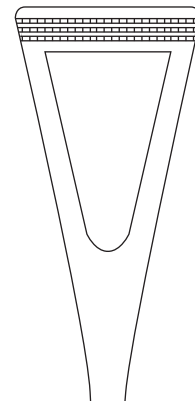

C10850
23 cm - 9"

IV - Pinces
IV - Forceps
IV - Pinzas

LOVELACE

Pince à poumons
Lung forceps
Pinza pulmonar

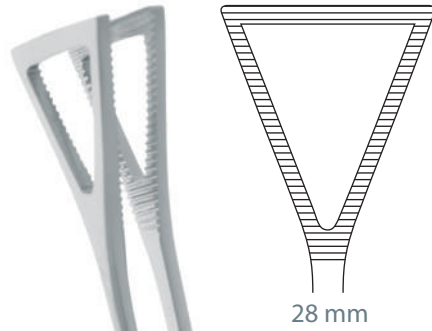

Branches droites
Straight branches
Ramas rectas

B655365

Branches courbes
Curved branches
Ramas curvas

B655370 

AUVERT



B655370
20 cm - 8"



B656025
20 cm - 8"

CHAPUT

2 x 3 griffes
2 x 3 teeth
2 x 3 dientes

13 cm - 5 1/8"

B65330

16 cm - 6 1/4"

B65335



20 cm - 8"

B65370

CHAPUT-MAYO

5 x 6 griffes
5 x 6 teeth
5 x 6 dientes

16 cm - 6 1/4"

B65420



20 cm - 8"

B65430

22 cm - 8 3/4"

B65440



B65335

16 cm - 6 1/4"



B65420

16 cm - 6 1/4"

ALLIS

Atraumatique
Non-traumatic
No traumática

4 x 5 griffes
4 x 5 teeth
4 x 5 dientes

5 x 6 griffes
5 x 6 teeth
5 x 6 dientes

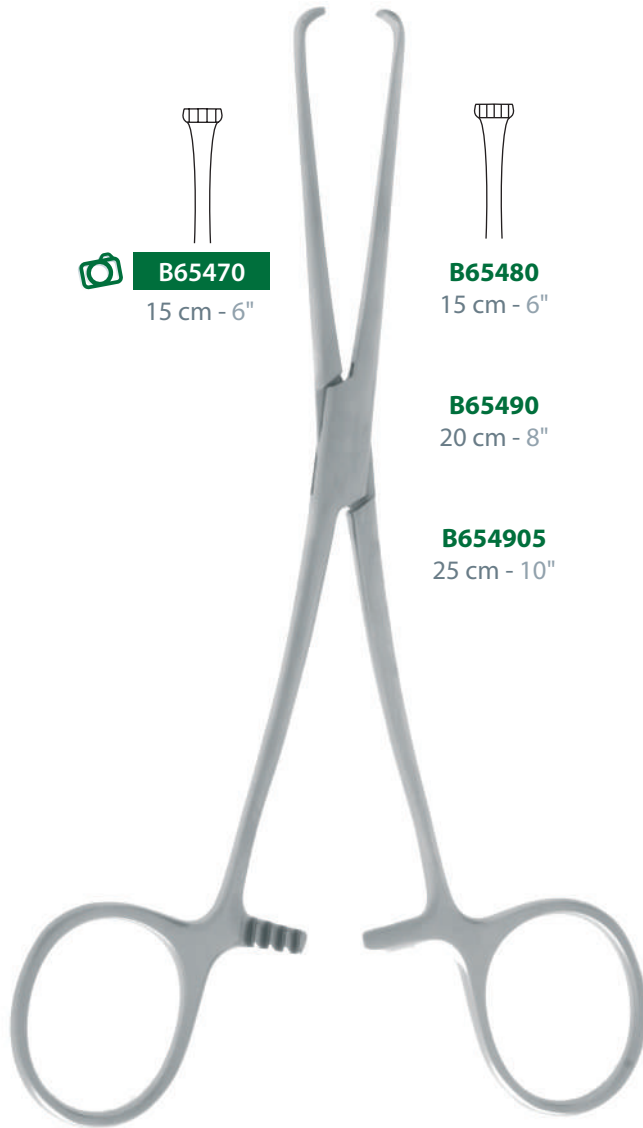
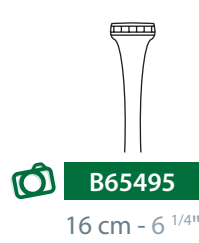
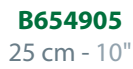
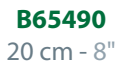
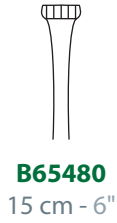

B65470
15 cm - 6"

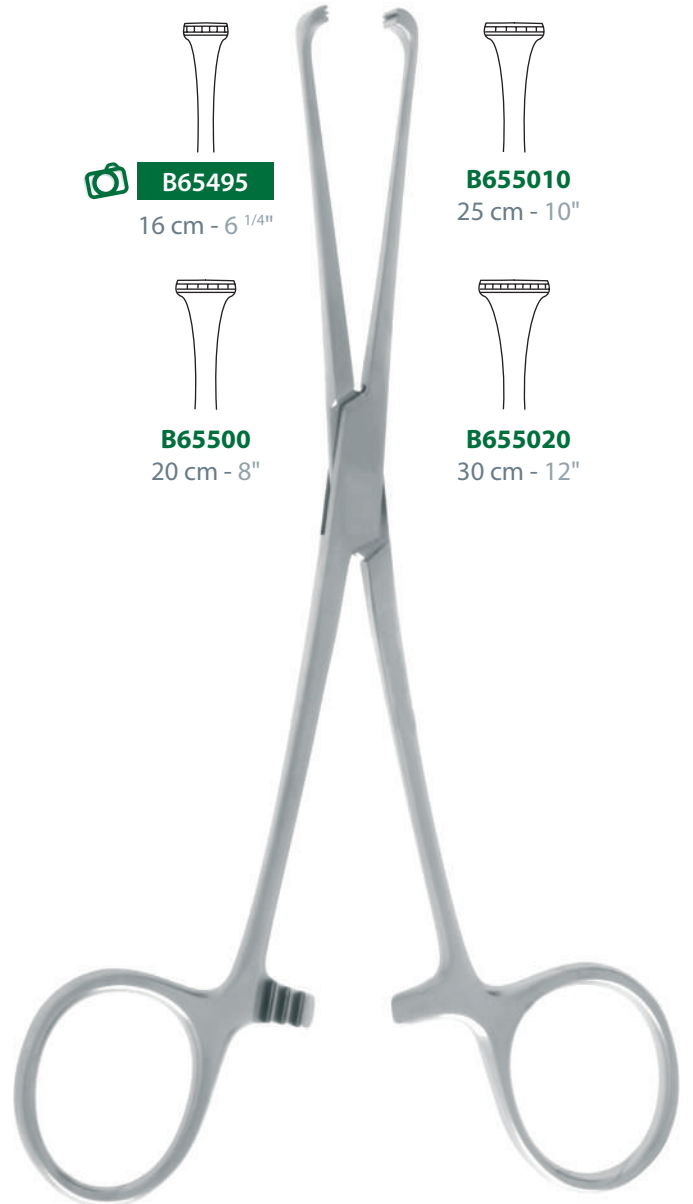

B65495
16 cm - 6 1/4"

BABY-ALLIS

4 x 5 griffes
4 x 5 teeth
4 x 5 dientes

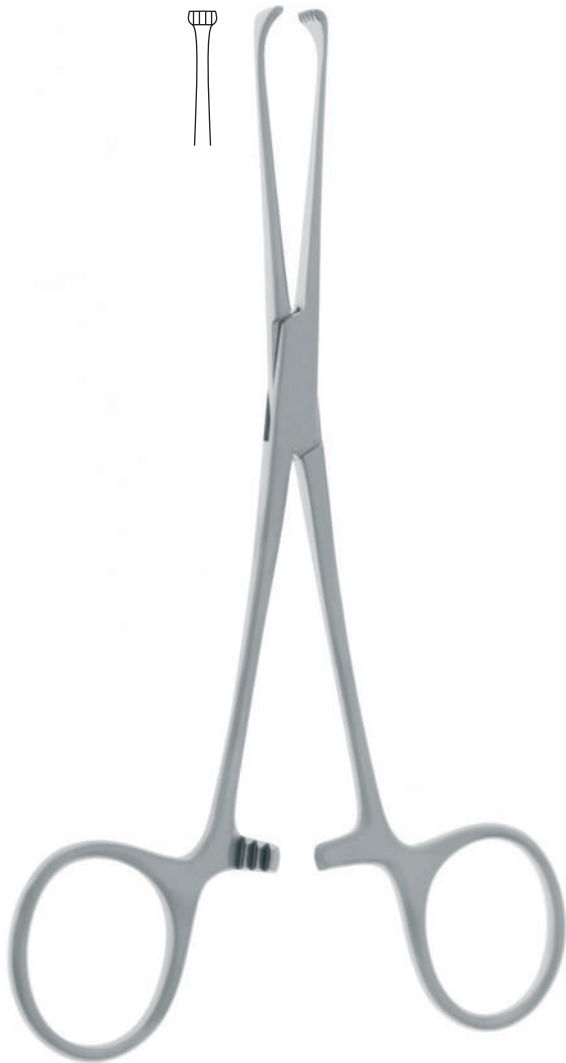

B654600
14 cm - 5 1/2"

JUDD-ALLIS

3 x 4 griffes
3 x 4 teeth
3 x 4 dientes



B654610



B654620
19 cm - 7 1/2"



B654610
15 cm - 6"



ALLIS-ADAIR

9 x 10 griffes
9 x 10 teeth
9 x 10 dientes



B654630
16 cm - 6 1/4"

BOYS-ALLIS

5 x 6 griffes
5 x 6 teeth
5 x 6 dientes



B654640
15 cm - 6"

LOCKWOOD-ALLIS

4 x 5 griffes
4 x 5 teeth
4 x 5 dientes

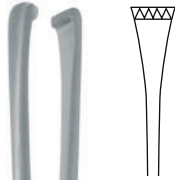

B654650
15 cm - 6"

THOMS-ALLIS

6 x 7 griffes
6 x 7 teeth
6 x 7 dientes



B654660
20 cm - 8"

IV - Pinces
IV - Forceps
IV - Pinzas

OMBREDANNE

TUFFIER

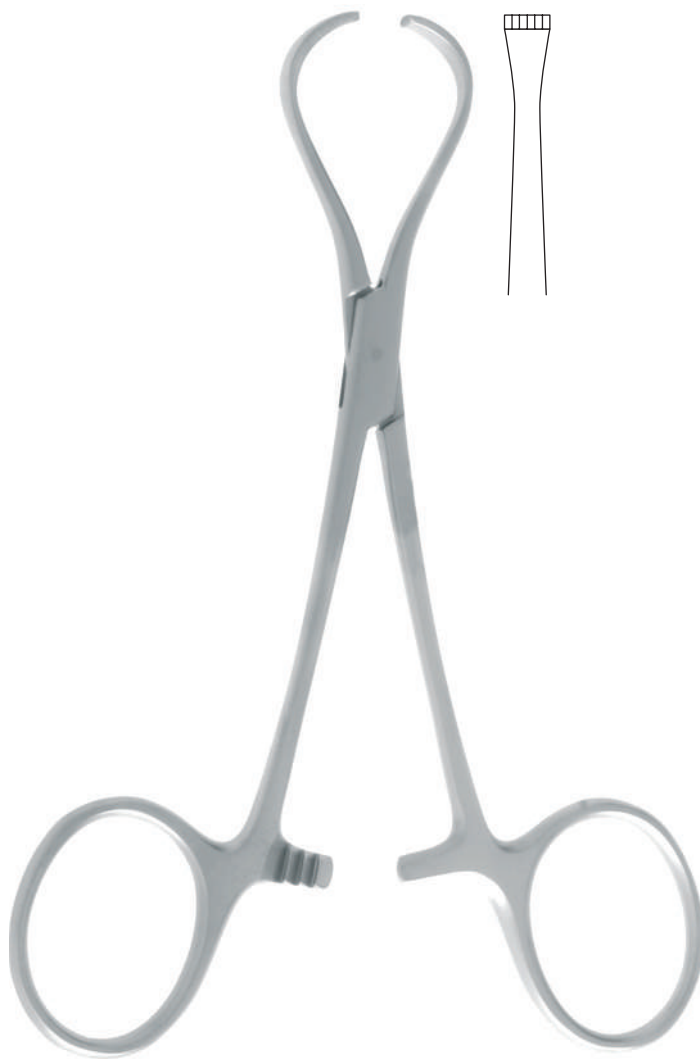

B50805
14 cm - 5 1/2"



B65515
13 cm - 5"

IV - Pinces
IV - Forceps
IV - Pinzas

LIEGE

3 x 4 griffes
3 x 4 teeth
3 x 4 dientes



B65530
26 cm - 10^{1/4}"

LITTLEWOOD

2 x 3 griffes
2 x 3 teeth
2 x 3 dientes



B655200
18,5 cm - 7^{1/4}"

BABCOCK

Mors non traumatisant
Non-traumatic jaws
Bocas no traumáticas



IV - Pinces
IV - Forceps
IV - Pinzas

BABCOCK



TC Inserts

16 cm - 6 1/4"

B60400



20 cm - 8"

B60420

Mors non traumatisant
Non-traumatic jaws
Bocas no traumáticas



9 mm

B60400

16 cm - 6 1/4"

10 mm

B60420

20 cm - 8"

B60400

16 cm - 6 1/4"

PRATT

Pince hémorroïdale
Haemorrhoidal clamps
Pinzas hemorroidales



B655340
15 cm - 6"

BENSON

Écarteur du pylore
Pylorus spreader
Separador para piloro



B655360
15,5 cm - 6 1/8"

Clamp pour suture bourse automatique
Automatique purse suture clamp
Clamp de sutura de becas automáticas



B655400
28 cm - 11"

DOYEN



B70070
18 cm - 7"

Crabe
Crabe
Cangrejo



B70100
9 cm - 3 1/2"

SCHADEL



B702300
9 cm - 3 1/2"

JONES



B702350
5 cm - 2"

Modèle britannique
British model
Modelo británico



B702355
9 cm - 3 1/2"



B702400
9 cm - 3 1/2"

IV - Pinces
IV - Forceps
IV - Pinzas

BACKHAUS

B70140
11 cm - 4 1/4"



B70130
9 cm - 3 1/2"



B70150
13 cm - 5"



B70160
14 cm - 5 1/2"

BACKHAUS

Porte-tube
Tube holder
Soporte para tubo

PEERS

Non perforante
Non-perforating
No perforante

BERNHARD



B70190
14 cm - 5 1/2"



B701700
16,5 cm - 6 1/2"



B70200
14,5 cm - 5 3/4"

TOHOKU

10 cm - 4"

B702450



13 cm - 5"

B702451

LORNA

10 cm - 4"

B702500



13 cm - 5"

B702505

Non perforante
Non-perforating
No perforante



B702450
10 cm - 4"



B702500
10 cm - 4"

ROEDER

13 cm - 5"

B70210

15 cm - 6"

B70220



Non perforante
No-perforating
No perforante



B70220
15 cm - 6"



B702250
14 cm - 5 1/2"

IV - Pinces
IV - Forceps
IV - Pinzas



GUNNAR-HEY

Pince à traire les drains - Drainage-tube drawing forceps - Pinza para ordenar las canulas

0 - 12 mm

B95100



0 - 20 mm

B951020



Aluminium
Aluminum
Aluminio



B951030

16 cm - 6 1/4"



B95100

17 cm - 6 3/4"

LANE (PAUCHET)

Droite
Straight
Recta

13 cm - 5"

B508090

15,5 cm - 6"

B508095

20 cm - 8"

B50810



Coudée
Angular
Angulada



B50810
20 cm - 8"



B50815
20 cm - 8"



LOCHARD

Pince ouvre capsule
Capsule-opening forceps
Pinza para abrir las capsulas



B95060
17 cm - 6 3/4"

MOHR

Presse-tube
Pinchoc clamps
Cierra tubos

- 5 cm - 2" **B950450** 
- 6 cm - 2 1/4" **B950460**
- 7 cm - 2 3/4" **B950470**
- 8 cm - 3 1/4" **B950480**



B950450

HOFFMAN

Presse-tube
Pinchoc clamps
Cierra tubos

- 17 mm - 0 2/3" **B95017** 
- 20 mm - 0 3/4" **B95020**
- 25 mm - 1" **B95025**
- 30 mm - 1 1/4" **B950300**
- 40 mm - 1 1/2" **B950400**



B95017

WEISS

Mors lisses
Smooth jaws
Bocas lisas

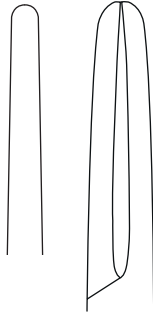

B952450

16,5 cm - 6 1/2"

B952460

18 cm - 7"



B952400

14,5 cm - 5 3/4"

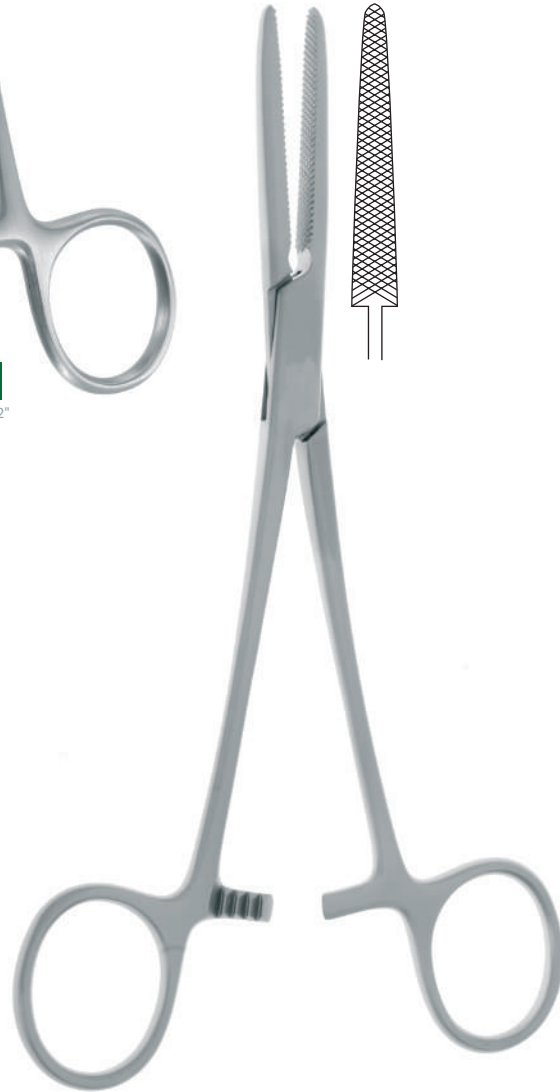

B95250

18 cm - 7"

IV - Pinces
IV - Forceps
IV - Pinzas

MURPHY

- 15 cm - 6" **B952014** 
- 18 cm - 7" **B952018**
- 20 cm - 8" **B952020**

Avec barre de protection
With safety rod
Con estribo de protección



B95150
16 cm - 6 1/4"

B952014
15 cm - 6"

B95150
16 cm - 6 1/4"

B95200
18 cm - 7"

Forte
Strong
Fuerte

B95205
19 cm - 7 1/2"

B95210
20 cm - 8"

Prestige

HALSTEAD

Droite
Straight
Recta

Courbe
Curved
Curva

Sans griffes
Without teeth
Sin dientes

A griffes
With teeth
Con dientes

Sans griffes
Without teeth
Sin dientes

A griffes
With teeth
Con dientes

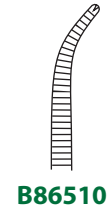
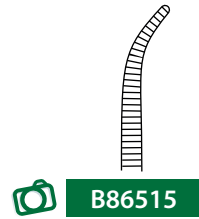
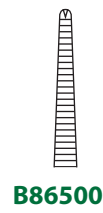
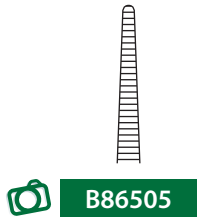

B86505
12 cm - 4 3/4"

B86515
12 cm - 4 3/4"

IV - Pinces
IV - Forceps
IV - Pinzas

Prestige



LERICHE

Droite
Straight
Recta

Courbe
Curved
Curva

Sans griffes A griffes
Without teeth With teeth
Sin dientes Con dientes

Sans griffes A griffes
Without teeth With teeth
Sin dientes Con dientes

	B86525	B86520	15 cm - 6"		B86535	B86530
	B86545	B86540	18 cm - 7"		B86555	B86550

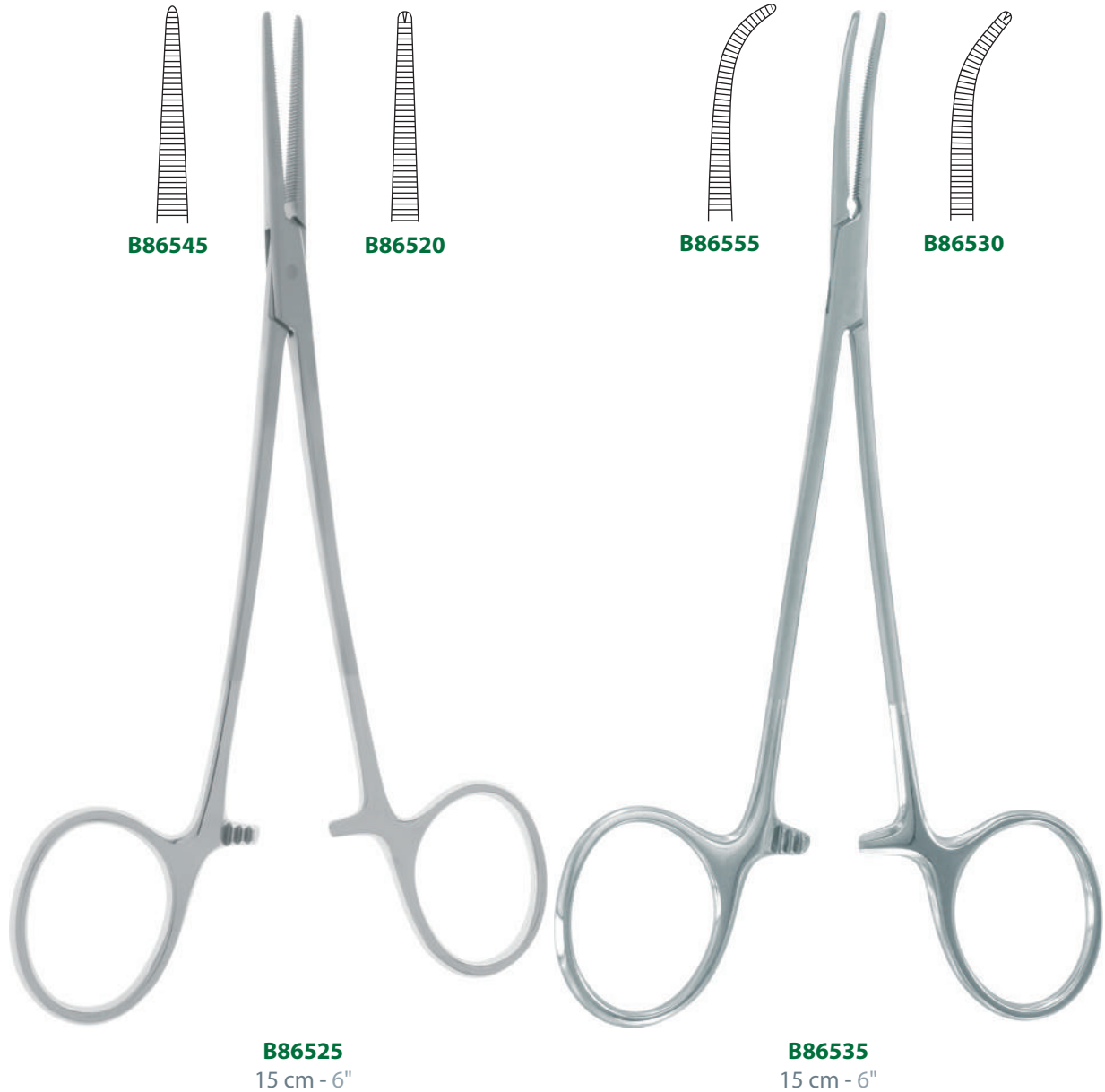

B86545

B86520

B86555

B86530

B86525
15 cm - 6"

B86535
15 cm - 6"

Prestige

BENGOLEA

Sans griffes
Without teeth
Sin dientes



B86560
21 cm - 8 1/4"

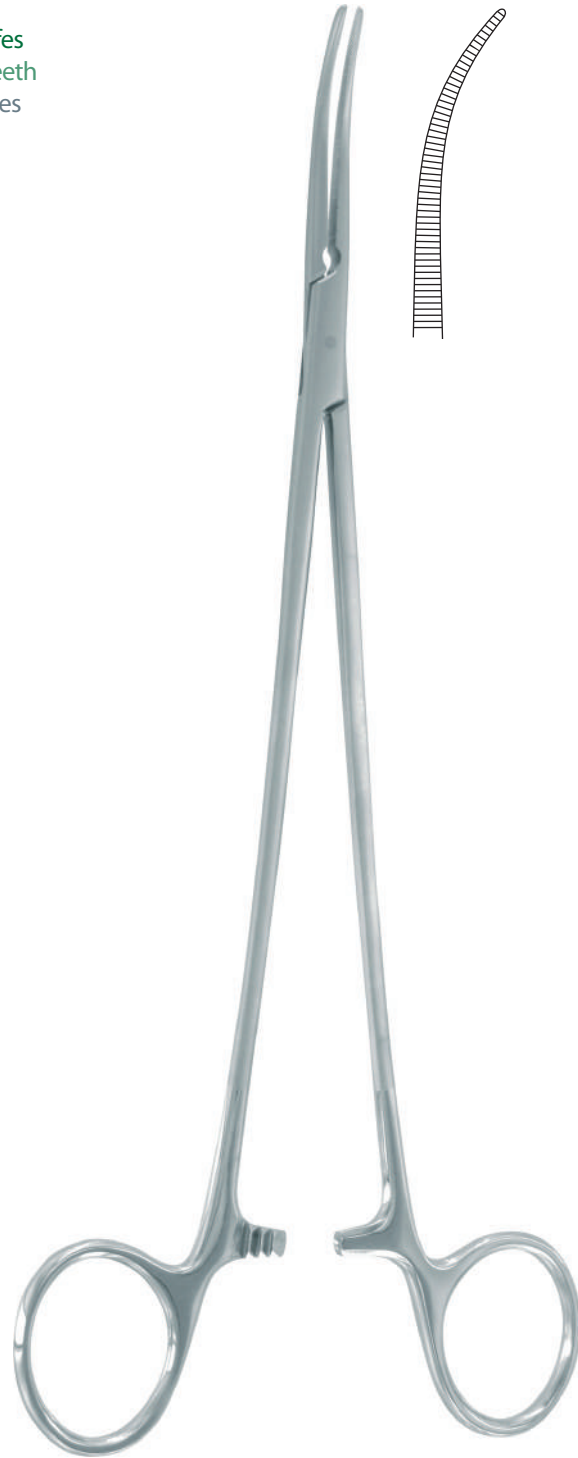

B86570
24 cm - 9 1/2"

IV - Pinces
IV - Forceps
IV - Pinzas

Prestige

KOCHER

A griffes
With teeth
Con dientes

KELLY

Sans griffes
Without teeth
Sin dientes

Droite
Straight
Recta

Courbe
Curved
Curva



B86580
16 cm - 6 1/4"



B86595
16 cm - 6 1/4"



B86595

B86590

Prestige

CRILE

CHRISTOPHE

Sans griffes
Without teeth
Sin dientes



B86600
14 cm - 5 1/2"



B86610
16 cm - 6 1/4"

IV - Pinces
IV - Forceps
IV - Pinzas

PEAN

12 cm - 4 ³/₄" **B50010** 

14 cm - 5 ¹/₂" **B50020**

16 cm - 6 ¹/₄" **B50025**

14 cm - 5 ¹/₂" **B50050** 

16 cm - 6 ¹/₄" **B50055**

A doigt
Collin's lock
Desmontable

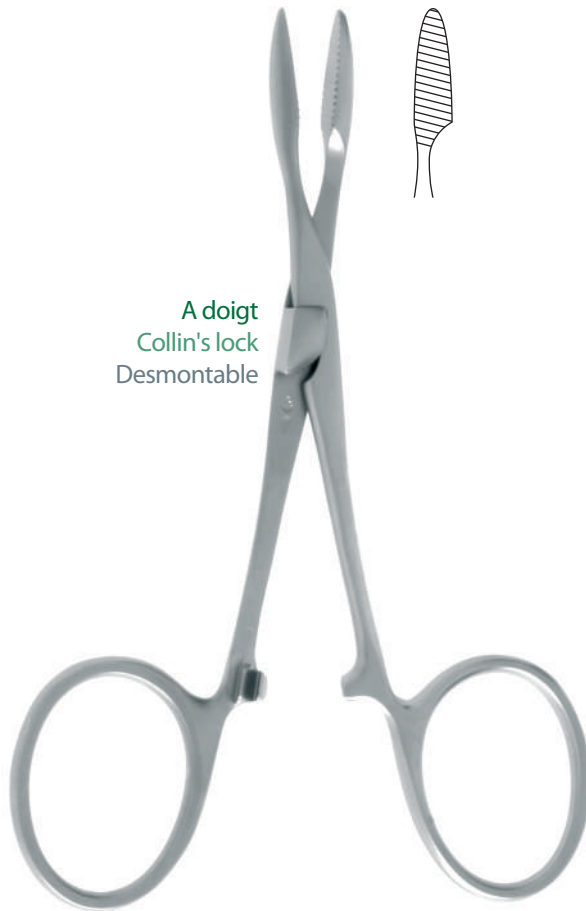

B50010
12 cm - 4 ³/₄"



B50050
14 cm - 5 ¹/₂"

Pince à pansements - Dressing forceps - Pinza para vendajes

Droite
Straight
Recta

Courbe
Curved
Curva



F10030 24 cm - 9 1/2"

F10040

F10050 30 cm - 11 3/4"

F10060

À doigt - Collin's lock - Desmontable

F10010 24 cm - 9 1/2"

F10020

CHERON

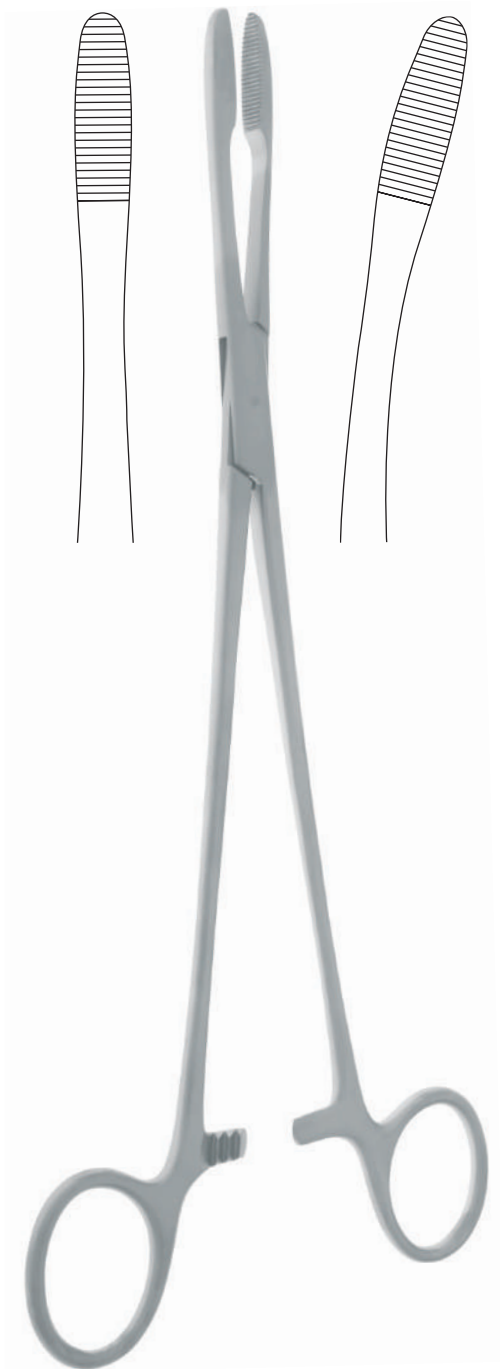

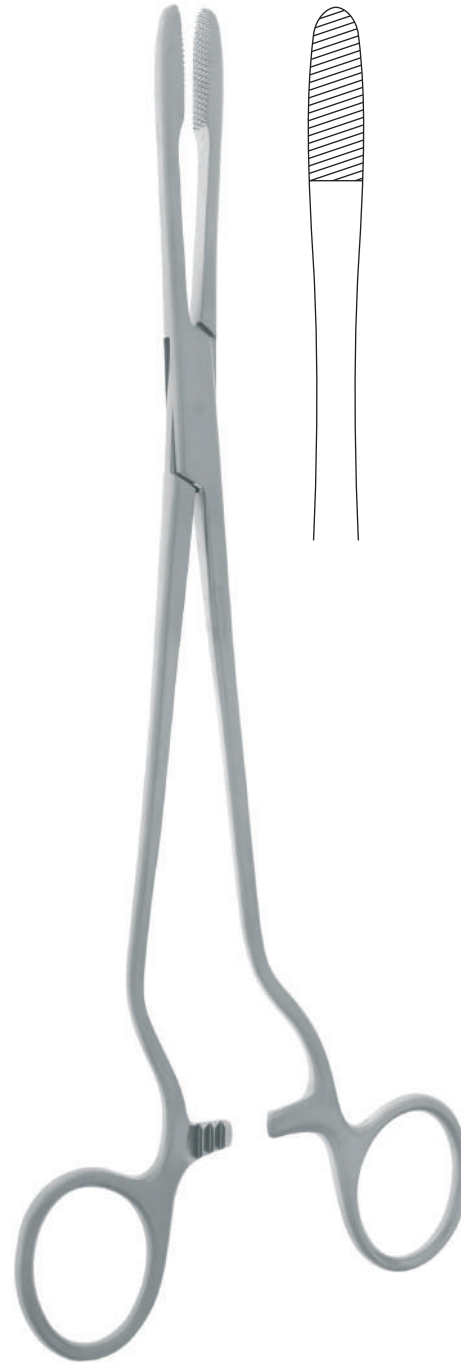

F10030
24 cm - 9 1/2"



F10100
24 cm - 9 1/2"

IV - Pinces
IV - Forceps
IV - Pinzas

GROSS MAYER

Droite Straight Recta		Courbe Curved Curva	
	B507701	20 cm - 8"	B507702
	B50780	25 cm - 10"	B50785 



B50780
25 cm - 10"



B50785
25 cm - 10"

ULRICH

Droite
Straight
Recta

Courbe
Curved
Curva

B507900

22 cm - 8^{3/4}"

B507901



B507910

27 cm - 10^{1/2}"

B507911



B507910
27 cm - 10^{1/2}"



B507911
27 cm - 10^{1/2}"

LANDANGER

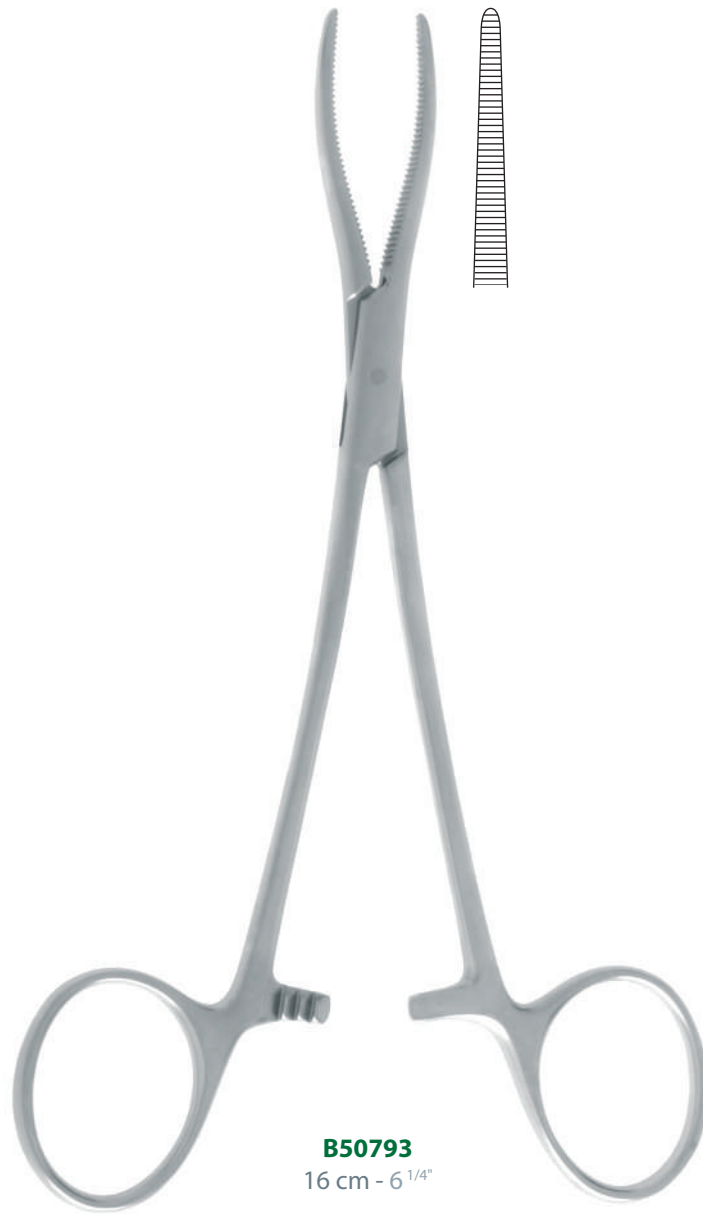

B50793
16 cm - 6 ¹/₄"



B50794
22 cm - 8 ³/₄"

RAMPLEY

18 cm - 7"

F101900





25 cm - 10"

F101910



F101900
18 cm - 7"

Pince à pansements - Dressing forceps - Pinza para vendajes

Droite Straight Recta		FOERSTER		Courbe Curved Curva	
Mors lisses Smooth jaws Boca liso	Mors striés Serrated jaws Boca estriada			Mors lisses Smooth jaws Boca liso	Mors striés Serrated jaws Boca estriada
F102000	F102080	18 cm - 7"		F102001	F102090
F102005	F10210	20 cm - 8"		F102006	F10220
 F102010	F10230	25 cm - 10"		 F102011	F10240

Mors lisses
Smooth jaws
Boca liso

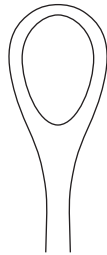

Mors striés
Serrated jaws
Boca estriada

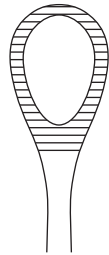

F102010
25 cm - 10"

Mors lisses
Smooth jaws
Boca liso



Mors striés
Serrated jaws
Boca estriada



F102011
25 cm - 10"

BOZEMANN

Droite
Straight
Recta



F102050

26 cm - 10 1/4"

Courbe
Curved
Curva

F102049

Double courbure
Double curvature
Doble curvatura



F102052

26 cm - 10 1/4"

F102051



F102050

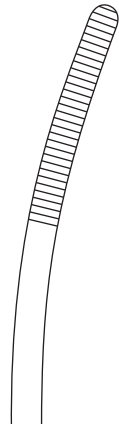

F102049

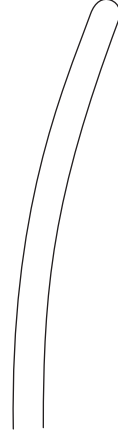

F102052

Mors lisses
Smooth jaws
Boca liso

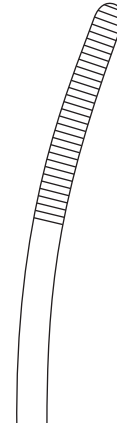

F102051

Mors striés
Serrated jaws
Boca estriada



F102050
26 cm - 10 1/4"



F102052
26 cm - 10 1/4"

IV - Pinces
IV - Forceps
IV - Pinzas

LISTER

12,5 cm - 5"

B507950

16 cm - 6 1/4"

B507955 

18 cm - 7"

B507960



B507955
16 cm - 6 1/4"

BRYANT

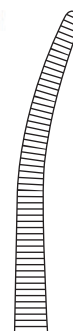

B507970
13 cm - 5"

EMMET



B507975
20 cm - 7 4/5"

PELKMANN

Droite
Straight
Recta

 **B507980** 26 cm - 10 1/4"

Courbe
Curved
Curva

B507981



B507980



B507981



B507980
26 cm - 10 1/4"

SIMS-MAIER

Droite
Straight
Recta

 **B507990** 28 cm - 11"

Courbe
Curved
Curva

B507991



B507990

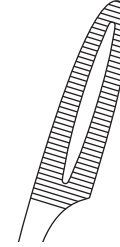

B507991



B507990
28 cm - 11"

Strippers - Strippers - Sondas para varices

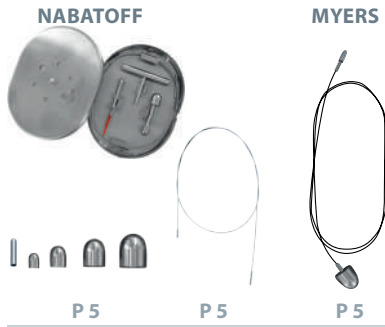

Sondes et spatules - Probes and Spatulas - Sondas y espátulas



Phlébectomie - Phlebotomy - Flebectomía

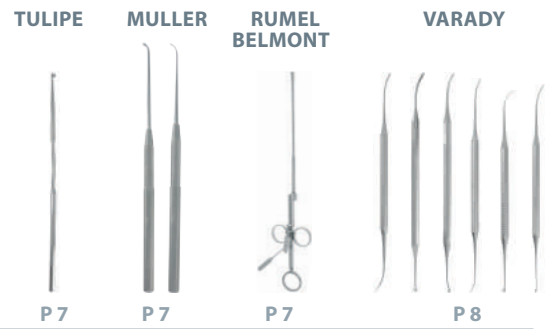

Clamps bulldog - Bulldog clamps - Clamp bulldog

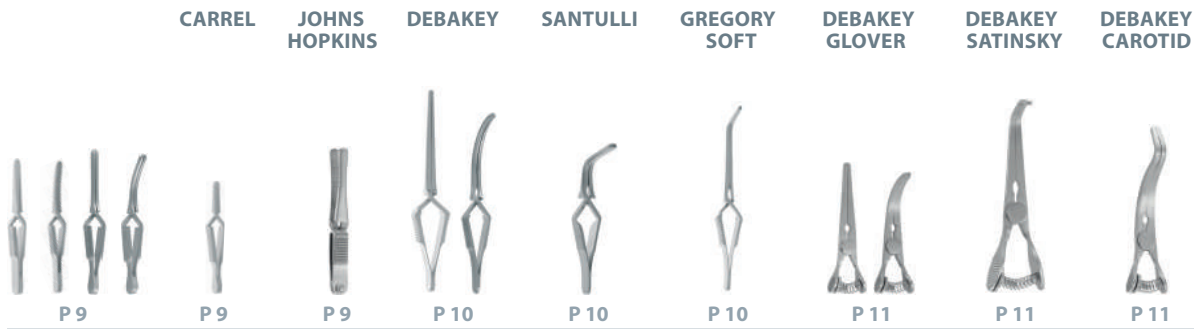

Pincers clamps vasculaires atrauma - Atrauma vascular forceps - Pinzas clamps vasculares atrauma

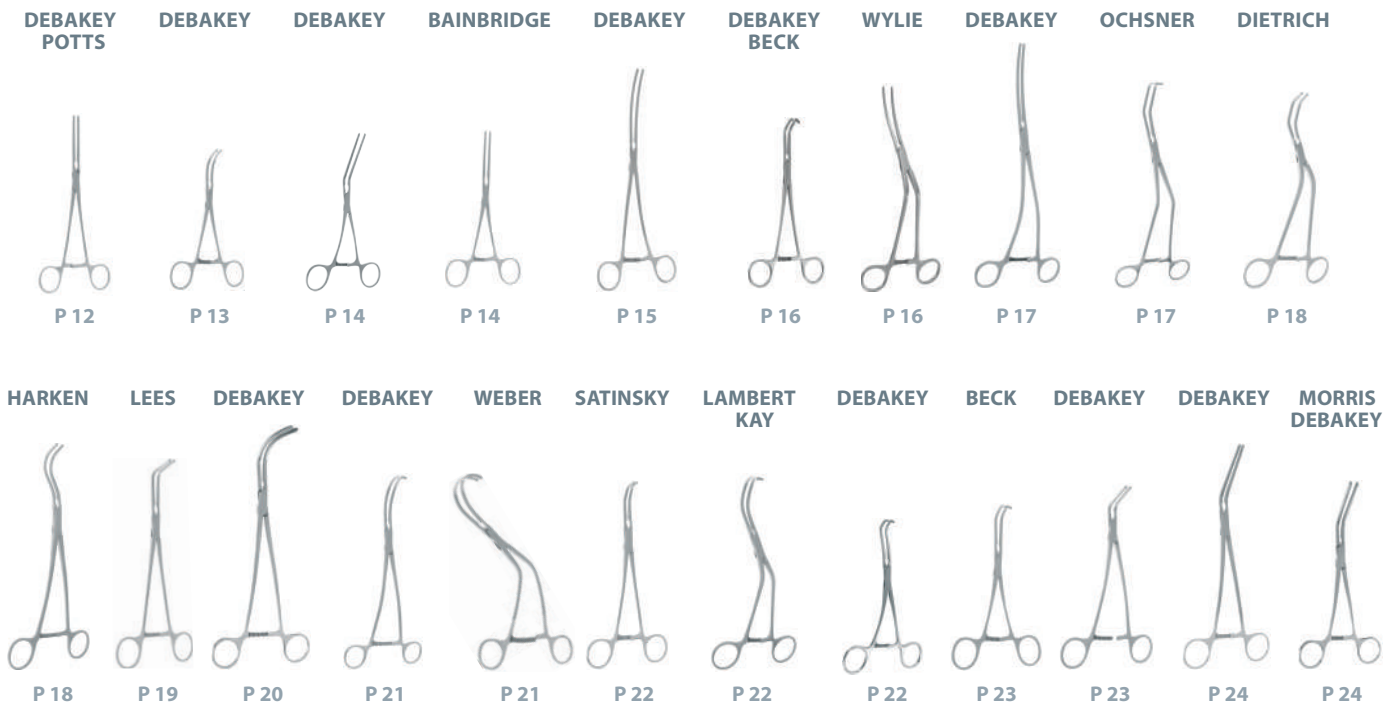

V - Clamps
V - Clamps
V - Clamps

DEBAKEY BAHNSON DEBAKEY PEAN DEBAKEY RANKIN DEBAKEY MOSQUITO DEBAKEY

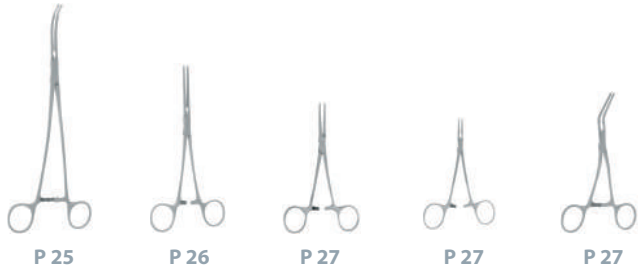

DEBAKEY GLOVER DERRA DALE GREGORY SUBRAMANIAN DEBAKEY JAVID COOLEY BECK

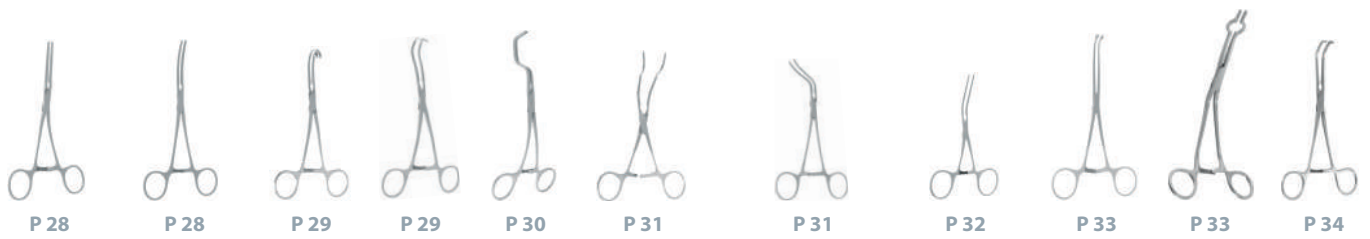

COOLEY DERRA COOLEY

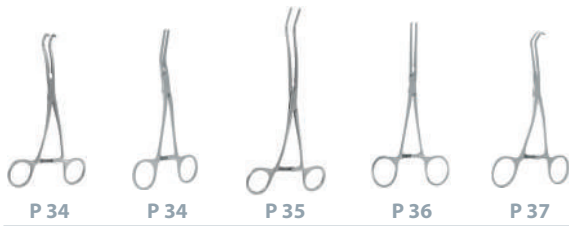

Pinces clamps nouveau né et pédiatrique - Neonatal and pediatric clamps - Pinzas clamps para recién nacidos y pediátrico

COOLEY CASTANEDA

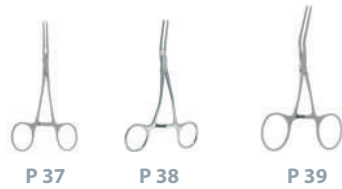

Dilatateurs vasculaires - Vascular dilators - Dilatadores vasculares

DEBAKEY COOLEY TUBBS

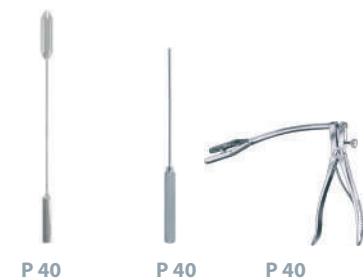

Pinces à dissection vasculaires - Vascular dissecting forceps - Pinzas para disección vasculares

II - Dissection
II - Dissecting
II - Disección

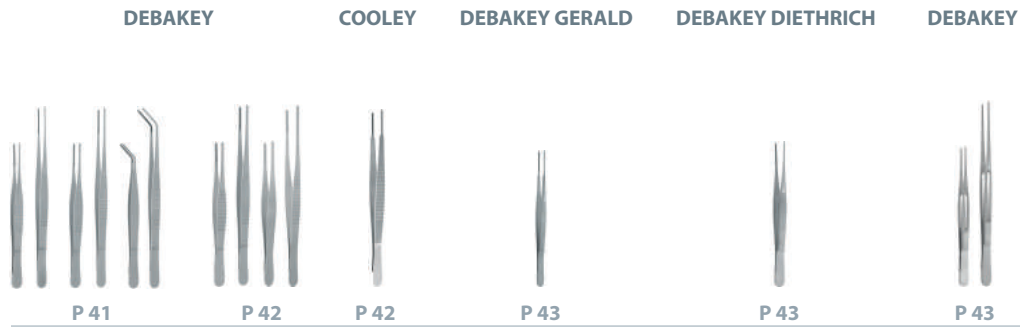

Ciseaux pour chirurgie vasculaire - Scissors for vascular surgery - Tijeras para cirugía vascular

III - Ciseaux
III - Scissors
III - Tijeras

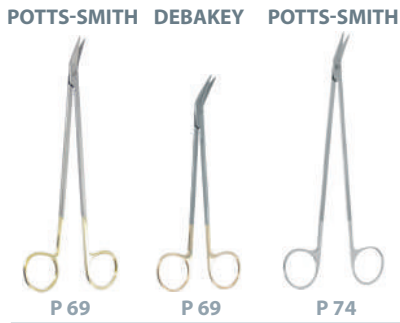
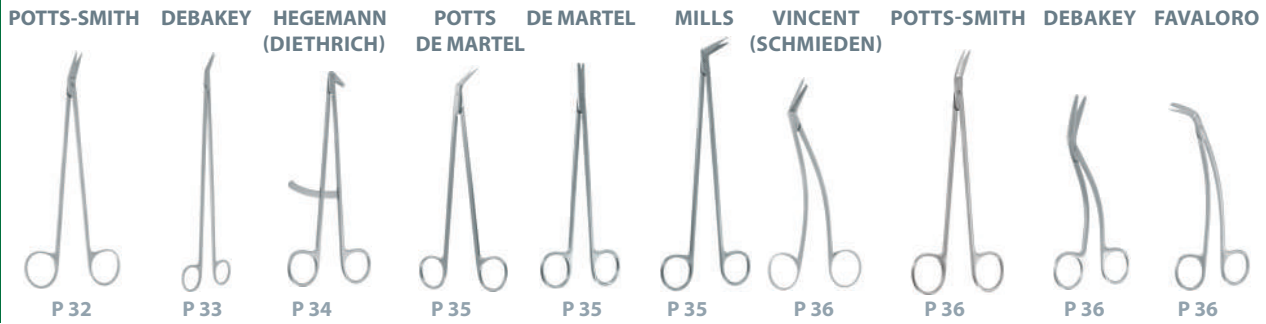

Canules - Cannulas - Cánulas

XV - Divers
XV - Miscellaneous
XV - Diversos



V - Clamps
V - Clamps
V - Clamps

V - Clamps
V - Clamps
V - Clamps

NABATOFF



Complet - Full set - Completo

C095000

135 x 100 x 25 mm



C095020

120 cm - 47 1/4"



C095010

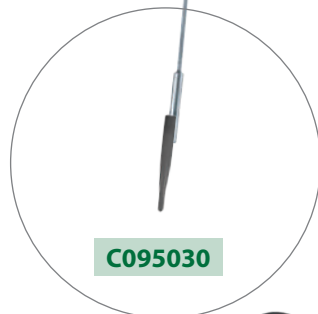

C095030



Ø 3 mm

C095033



Ø 6 mm

C095036



Ø 9 mm

C095039



Ø 12 mm

C095042



Ø 15 mm

C095045

MYERS

Ø 6 mm **C095106**

Ø 9 mm **C095109**

Ø 12 mm **C095112** 

Ø 15 mm **C095115**

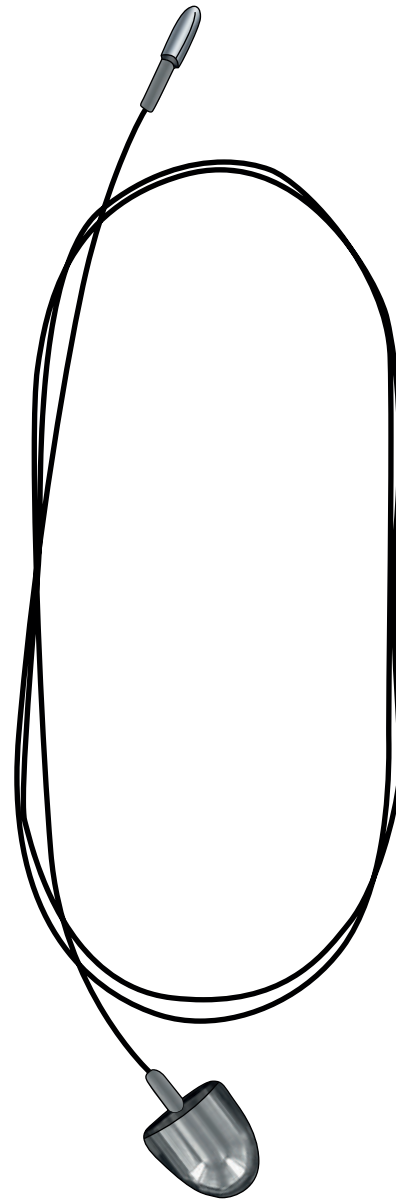

C095112



SCHMID

Ø extérieur - outside - exterior

18,5 cm - 7 1/4" **J082020** 

21,5 cm - 8 1/2" **J082030**

Ø 2 mm **C095302**

Ø 3 mm **C095303**

Ø 4 mm **C095304**

Ø 6 mm **C095306**

Ø 7 mm **C095307**

Ø 8,5 mm **C095308**

Ø 10 mm **C095310** 

Ø 12 mm **C095312**

Ø 14 mm **C095314**



Mousse
Blunt
Roma

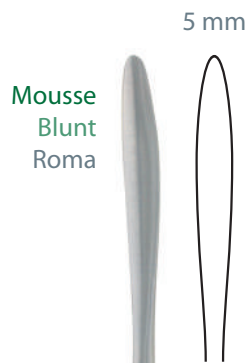

Mousse
Blunt
Roma

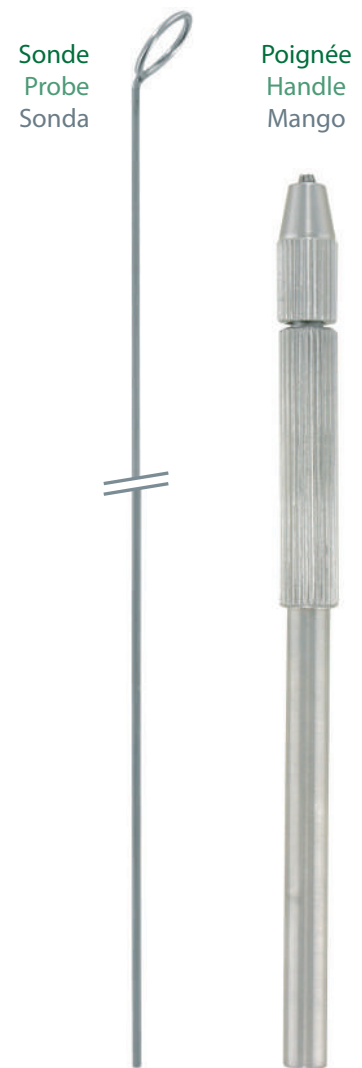

Sonde
Probe
Sonda

Poignée
Handle
Mango

J082020
18,5 cm - 7 1/4"

J082010
14 cm - 5 1/2"

C095310
55 cm - 21 1/2"

C095300
12 cm - 4 3/4"

TULIPE

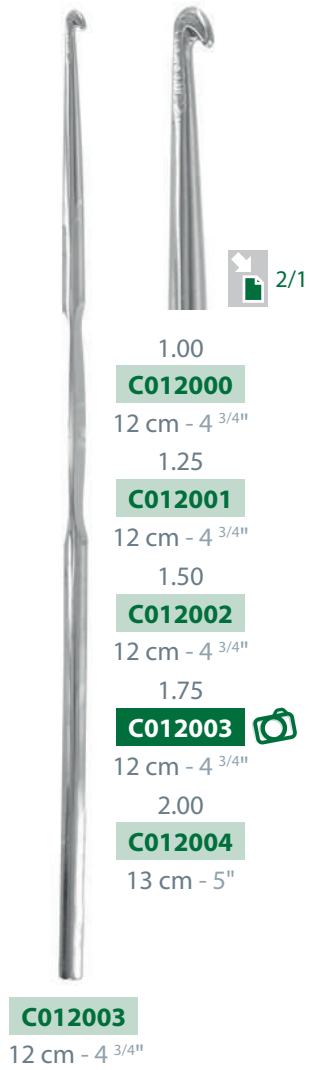

MULLER

Crochets à phlébectomie - Phlebectomy hooks - Ganchos para flebectomía

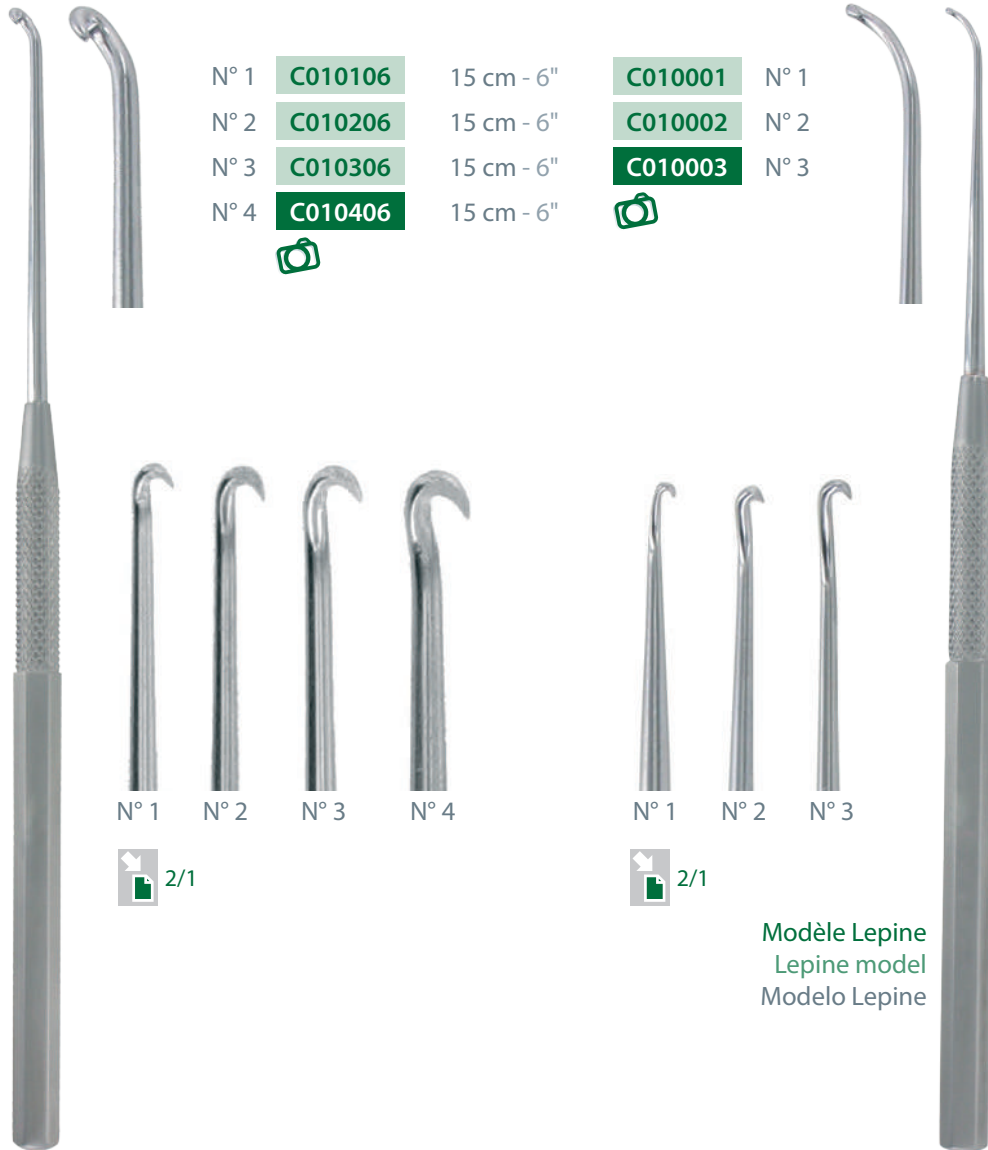

RUMEL BELMONT

TOURNIQUET VASCULAIRE VASCULAR TOURNIQUET TOURNIQUETE VASCULAR

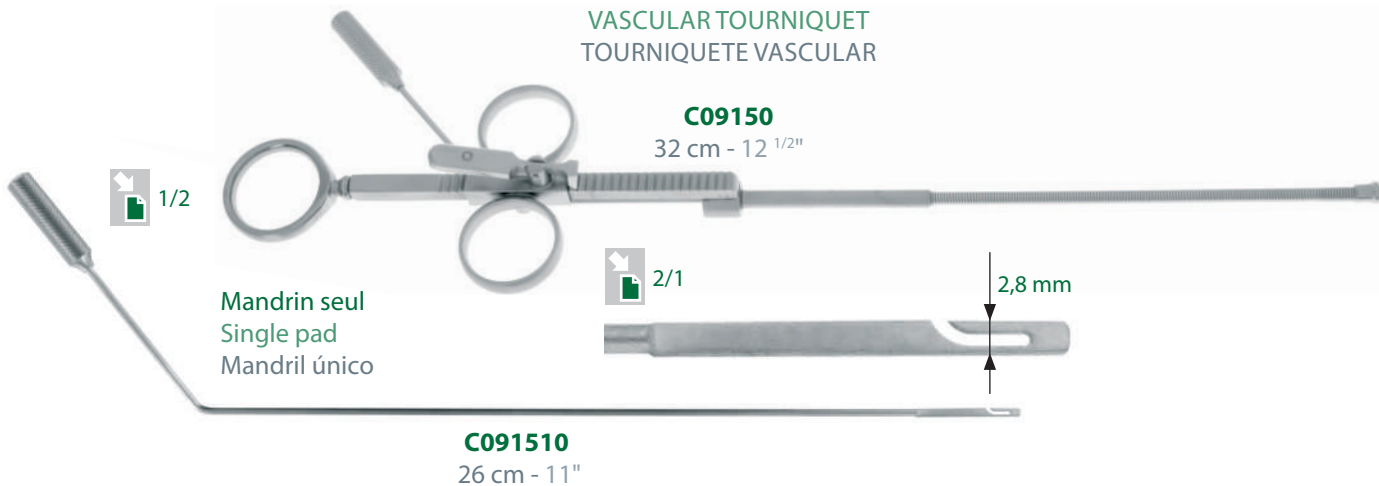

V - Clamps
V - Clamps
V - Clamps

VARADY

Dissecteur
Dissector
Disector

Extracteur
Extractor
Extractor

Extracteur
Extractor
Extractor

Micro-spatule
Micro-spatula
Micro-espatula

Micro-spatule
Micro-spatula
Micro-espatula

Micro-extracteur
Micro-extractor
Micro-extractor



C011010
18 cm - 7"



C011020
18 cm - 7"



C011030
18 cm - 7"



C011040
17 cm - 6 3/4"



C011050
17 cm - 6 3/4"



C011060
17 cm - 6 3/4"

LANDANGER

Clamps bulldog - Bulldog clamps - Clamp bulldog

Droit Straight Recto	STANDARD STANDARD STANDARD	Courbe Curve Curvo	Droit Straight Recto	FIN FINE FINO	Courbe Curve Curvo
C10170	3,5 cm - 1 1/3"	C10195	C101701	3,5 cm - 1 1/3"	C101951
C10175	4 cm - 1 1/2"	C10200	C101751	4 cm - 1 1/2"	C102001
C10180	5 cm - 2"	C10205	C101801	5 cm - 2"	C102051
C10185	6 cm - 2 1/4"	C10210	C101851	6,5 cm - 2 1/2"	C102101
C10190	7 cm - 2 3/4"	C10215	C101901	7 cm - 2 3/4"	C102151



C10185
6 cm - 2 1/4"



C10210
6 cm - 2 1/4"



C101851
6,5 cm - 2 1/2"



C102101
6,5 cm - 2 1/2"

CARREL

CLAMP POUR LYMPHOGRAPHIE
LYMPHOGRAPHIA CLAMP
CLAMP PARA LINFOGRAFÍA



C10220
5 cm - 2"



C102304
6,3 cm - 2 1/2"



C102304



Droit Straight Recto	Courbe Curve Curvo
C102301	3,8 cm - 1 1/3"
C102302	5,1 cm - 2"
C102303	5,7 cm - 2 1/4"
C102304	6,3 cm - 2 1/2"
C102305	7,0 cm - 2 3/4"
C102306	7,5 cm - 3"
C102307	9,0 cm - 3 1/2"



C102404

JOHNS HOPKINS

V - Clamps
V - Clamps
V - Clamps



Clamps bulldog - Bulldog clamps - Clamp bulldog



DeBakey

DEBAKEY

Droit Straight Recto	Courbe Curve Curvo
----------------------------	--------------------------

-	7,0 cm - 2 3/4"	C10080
C10060	7,5 cm - 3"	-
-	8,0 cm - 3 1/8"	C10085
C10065	8,5 cm - 3 1/4"	-
-	10,0 cm - 4"	C10090
C10070	10,5 cm - 4 1/4"	-
-	11,5 cm - 4 1/2"	C10095
C10075	12,0 cm - 4 3/4"	-



C10070
10,5 cm - 4 1/4"



C10090
10 cm - 4"

PINCE À POSER LES CLAMPS
CLAMP SETTING FORCEPS
PINZA PARA COLOCAR CLAMPS



C10100
24 cm - 9 1/2"

SANTULLI



C10096
7 cm - 2 3/4"

GREGORY SOFT



C10099
12 cm - 4 3/4"

C10098
11 cm - 4 1/4"

Clamps bulldog - Bulldog clamps - Clamp bulldog



DeBakey

DEBAKEY GLOVER



C101101
7 cm - 2 3/4"

Droit
Straight
Recto

-	4,0 cm - 1 1/2"	C101231
-	4,5 cm - 1 3/4"	C101251
C101051	5,0 cm - 2"	C101421
-	6,5 cm - 2 1/2"	C101301
	C101101	-
-	8,0 cm - 3 1/4"	C101351
C101151	8,5 cm - 3 1/2"	-
-	11,5 cm - 4 1/2"	C101401
C101201	12,5 cm - 5"	-

Courbe
Curve
Curvo



C101301
6,5 cm - 2 1/2"



C101421
5 cm - 2"

DEBAKEY SATINSKY



C10150

10 cm - 4"

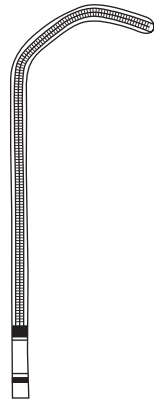

C10145

7 cm - 2 3/4"

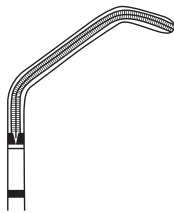

DEBAKEY CAROTID



C10155
9 cm - 3 1/2"

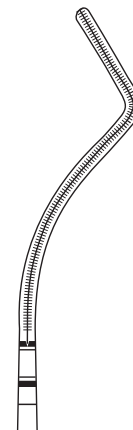



DeBakey

DEBAKEY POTTS

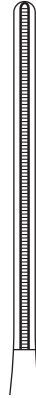

C10265
21 cm - 8^{1/4"}



 **C10270**
22 cm - 8^{3/4"}

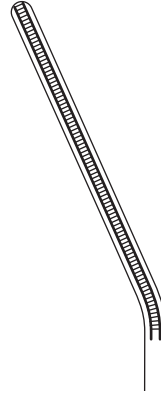

C10275
21 cm - 8^{1/4"}

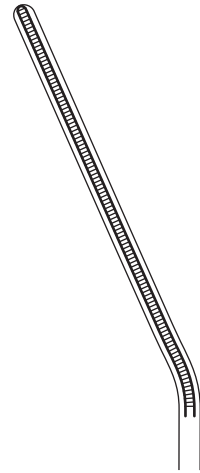

C10280
22 cm - 8^{3/4"}



C10285
21 cm - 8^{1/4"}

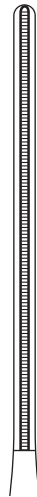

C10290 
22 cm - 8^{3/4"}

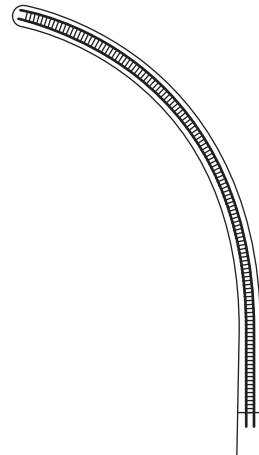

 **C10295**
22 cm - 8^{3/4"}

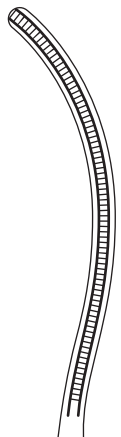

C10300
22 cm - 8^{3/4"}

V - Clamps
V - Clamps
V - Clamps



DeBakey

DEBAKEY

POUR DISSECTION ET LIGATURE
FOR DISSECTING AND LIGATURE
PARA DISECCIÓN Y LIGADURAS



C10320
16 cm - 6 ³/₄"



C10310
19 cm - 7 ¹/₂"

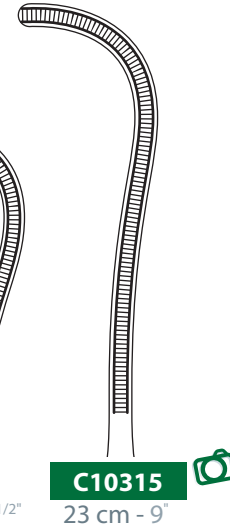

C10315 
23 cm - 9"



C10325 
19 cm - 7 ¹/₂"

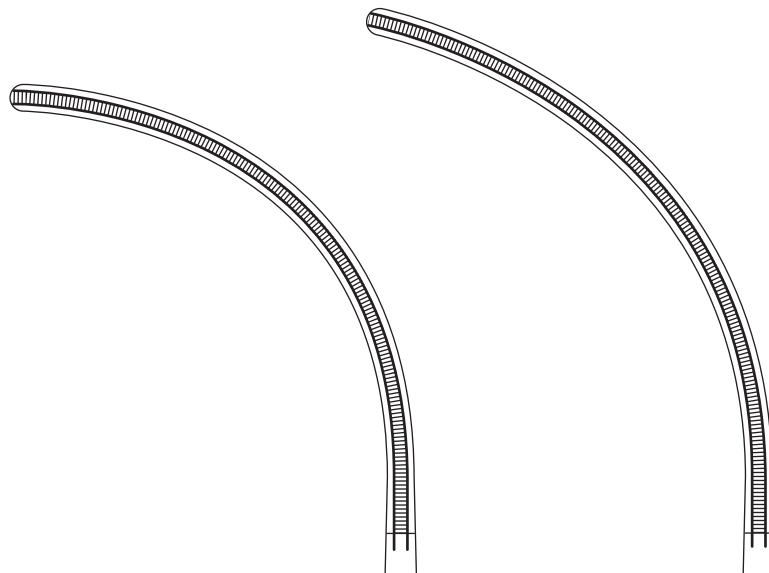

C10330
20 cm - 8"

V - Clamps
V - Clamps
V - Clamps



DeBakey

DEBAKEY
(LELAND JONES)



C10335
18 cm - 7"



C10340 
19 cm - 7 1/2"

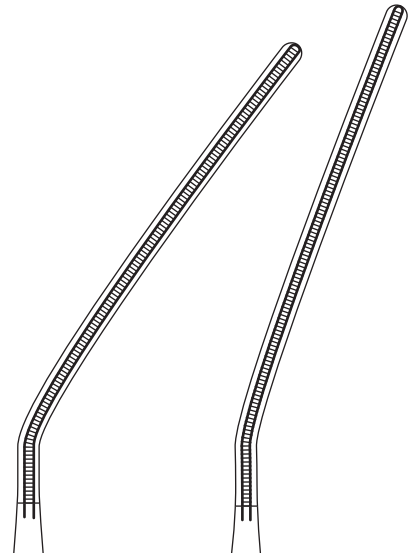

C10345
20 cm - 8"

BAINBRIDGE



C10350
15 cm - 6"



C10355 
18 cm - 7"

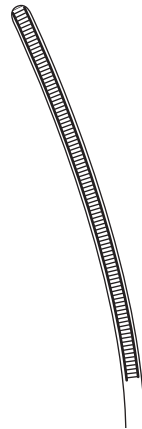

C10360
15 cm - 6"

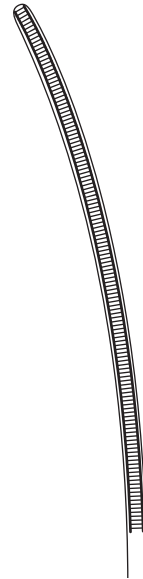

C10365
18 cm - 7"



DeBakey

POUR ARTÈRE RÉNALE
FOR RENAL ARTERY
PARA ARTERIA RENAL

DEBAKEY

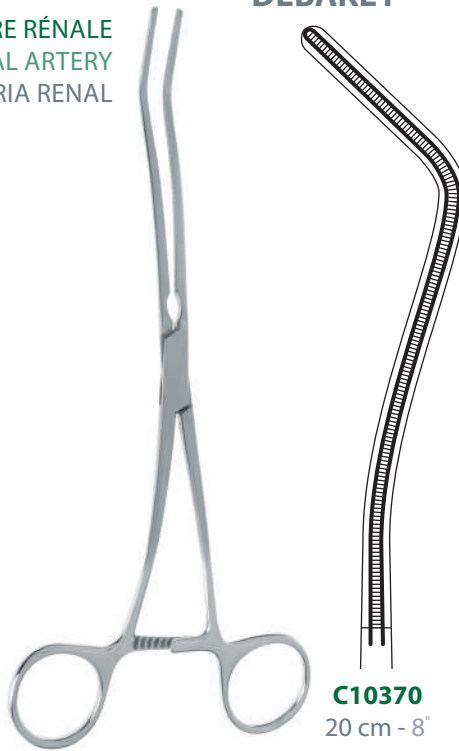

C10370
20 cm - 8"



C10375
26 cm - 10 ¹/₄"

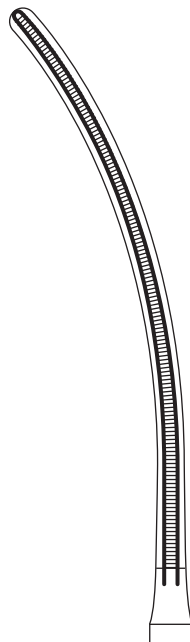

C10380 
27 cm - 10 ¹/₂"

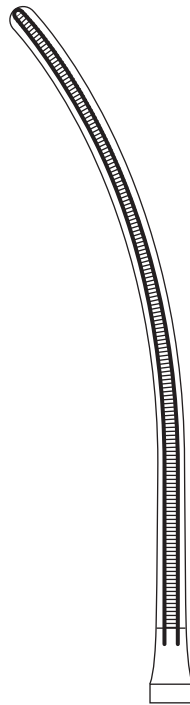

C10385
31 cm - 12 ¹/₄"

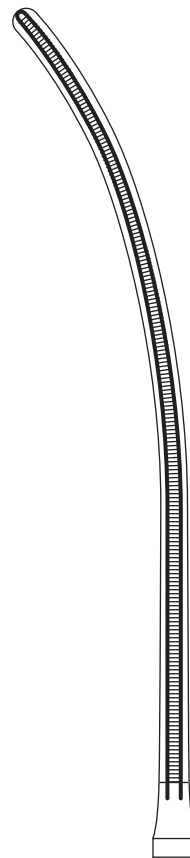

C10390
33 cm - 13"

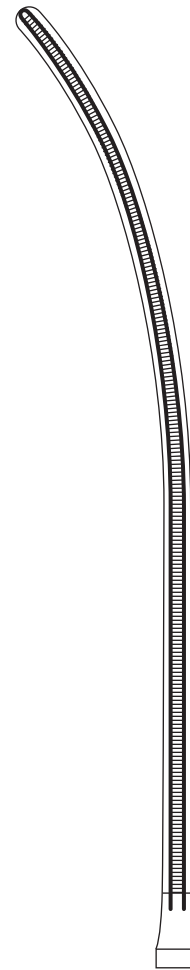

V - Clamps
V - Clamps
V - Clamps



DeBakey

DEBAKEY-BECK

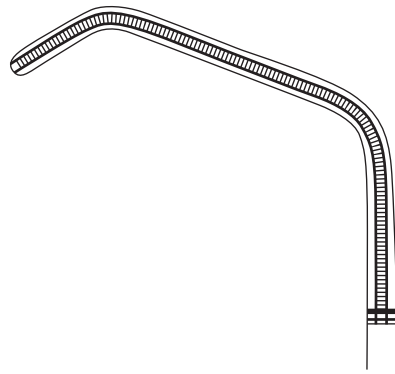

C103905
21 cm - 8 1/4"

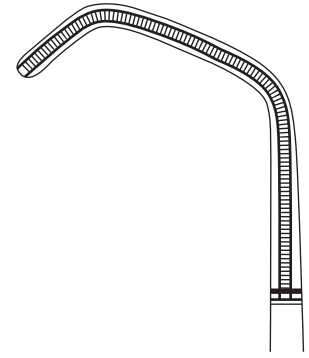

 **C103910**
20,5 cm - 8"

WYLIE

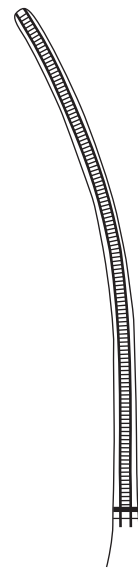

C103920
24 cm - 9 1/2"

V - Clamps
V - Clamps
V - Clamps



DeBakey

DEBAKEY

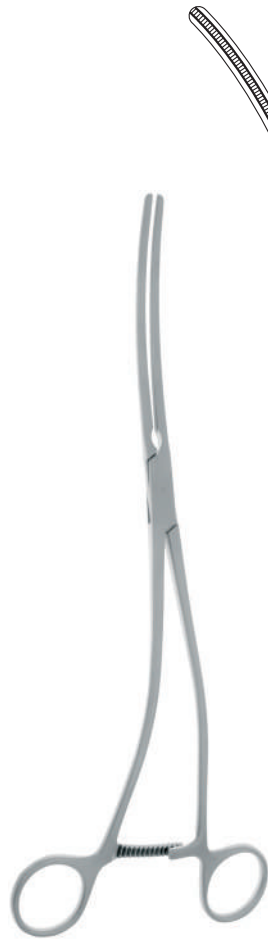

C10400
30 cm - 11 ³/₄"



C10395
28 cm - 11"

OCHSNER

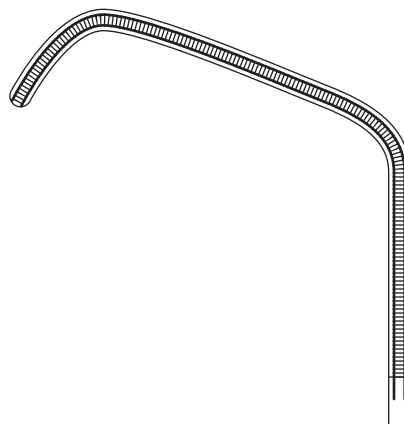

C10742
23,5 cm - 9 ¹/₄"

V - Clamps
V - Clamps
V - Clamps



DeBakey



DIETRICH

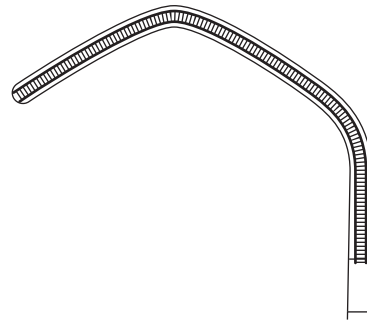

C10744
20 cm - 8"

HARKEN

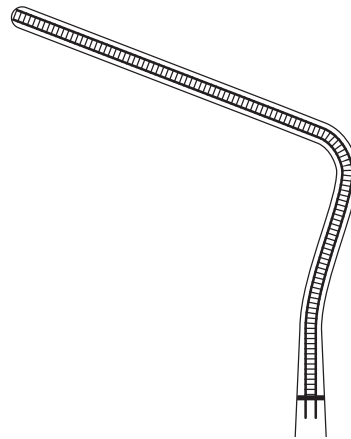

C10500
24 cm - 9 1/2"

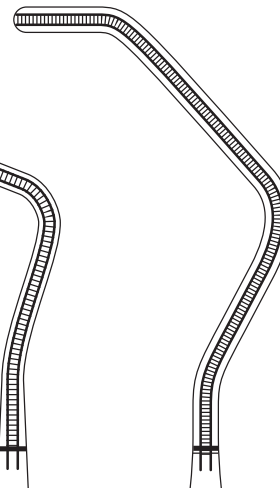

C10495
24 cm - 9 1/2"

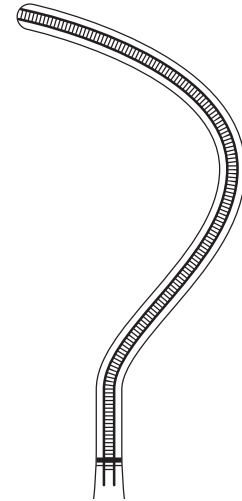

C10490
24 cm - 9 1/2"

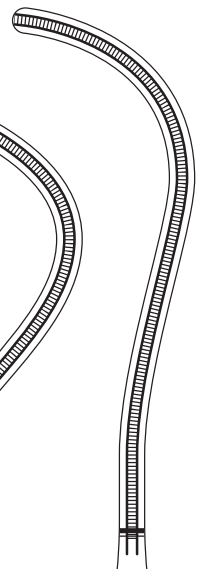

C10485
24 cm - 9 1/2"

V - Clamps
V - Clamps
V - Clamps



DeBakey

LEES



POUR LES BRONCHES
FOR BRONCHUS
PARA LOS BRONQUIOS

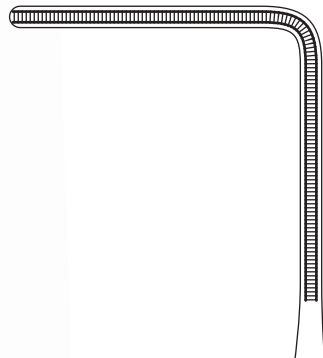

C10505 
23 cm - 9"

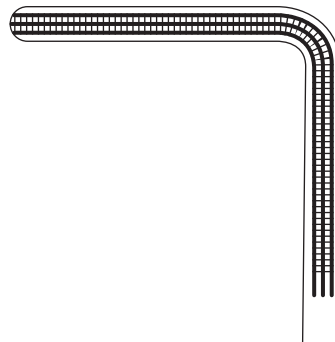

C10510
25 cm - 10"



POUR LES BRONCHES
FOR BRONCHUS
PARA LOS BRONQUIOS

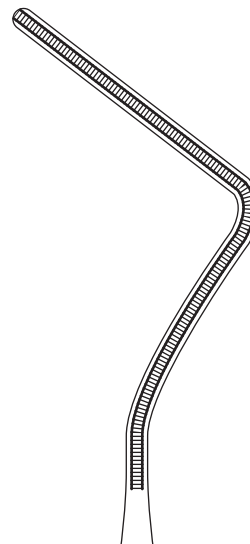

C10515
25 cm - 10"

V - Clamps
V - Clamps
V - Clamps



DeBakey



DEBAKEY

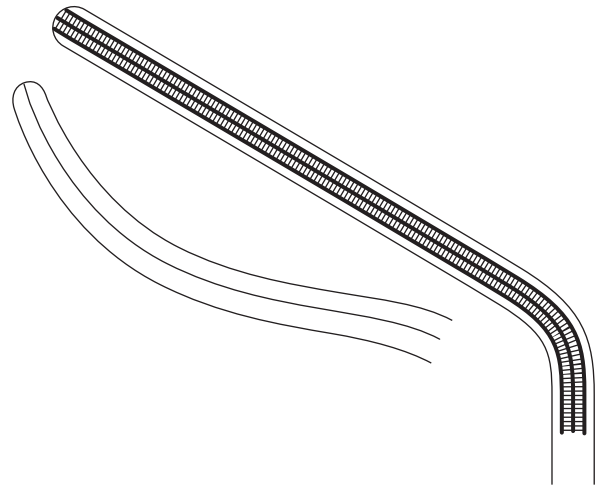

C10405
27 cm - 10 1/2"

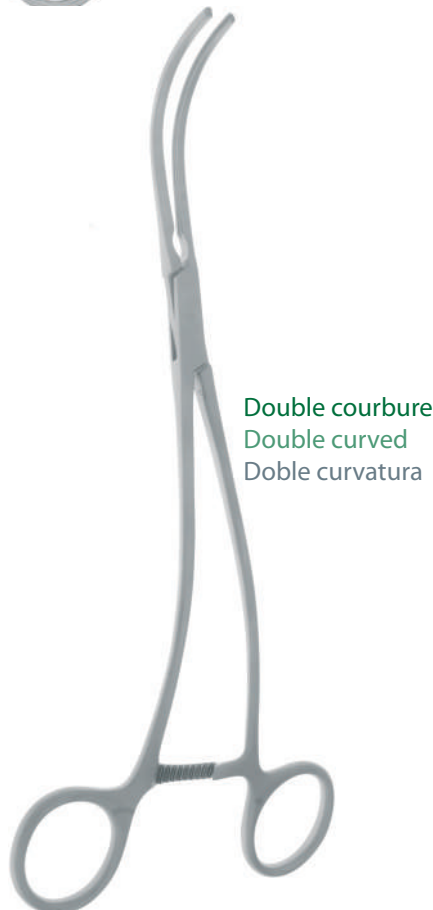



Double courbure
Double curved
Doble curvatura

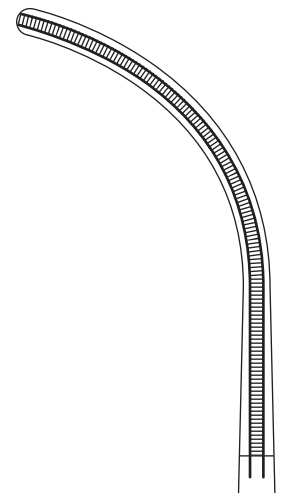

POUR LIGATURE
FOR LIGATURE
PARA LIGADURA

C10410
24 cm - 9 1/2"



C10415 
24 cm - 9 1/2"

V - Clamps
V - Clamps
V - Clamps



DeBaKey

DEBAKEY



POUR LIGATURE
FOR LIGATURE
PARA LIGADURA



C10420
25 cm - 10"

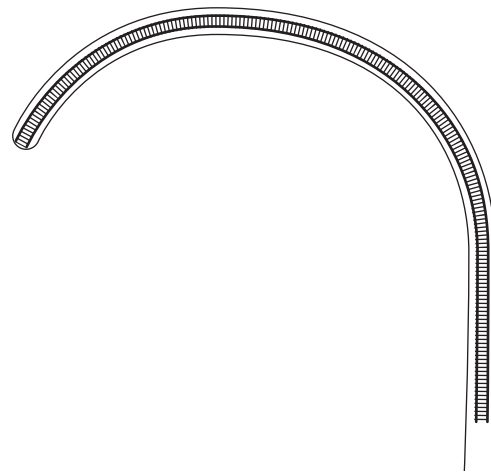

C10425 
26 cm - 10 1/4"

WEBER





A droite
On the Right
A la derecha

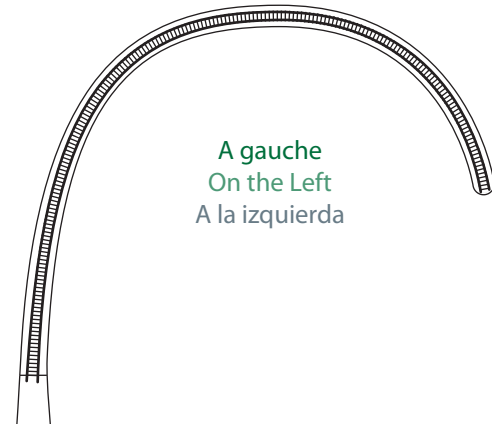

C10430
26 cm - 10 1/4"

A gauche
On the Left
A la izquierda



C10435 
26 cm - 10 1/4"

V - Clamps
V - Clamps
V - Clamps



DeBakey

SATINSKY

POUR OCCLUSION TANGENTIELLE
FOR TANGENTIAL OCCLUSION
PARA OCLUSIÓN TANGENCIAL

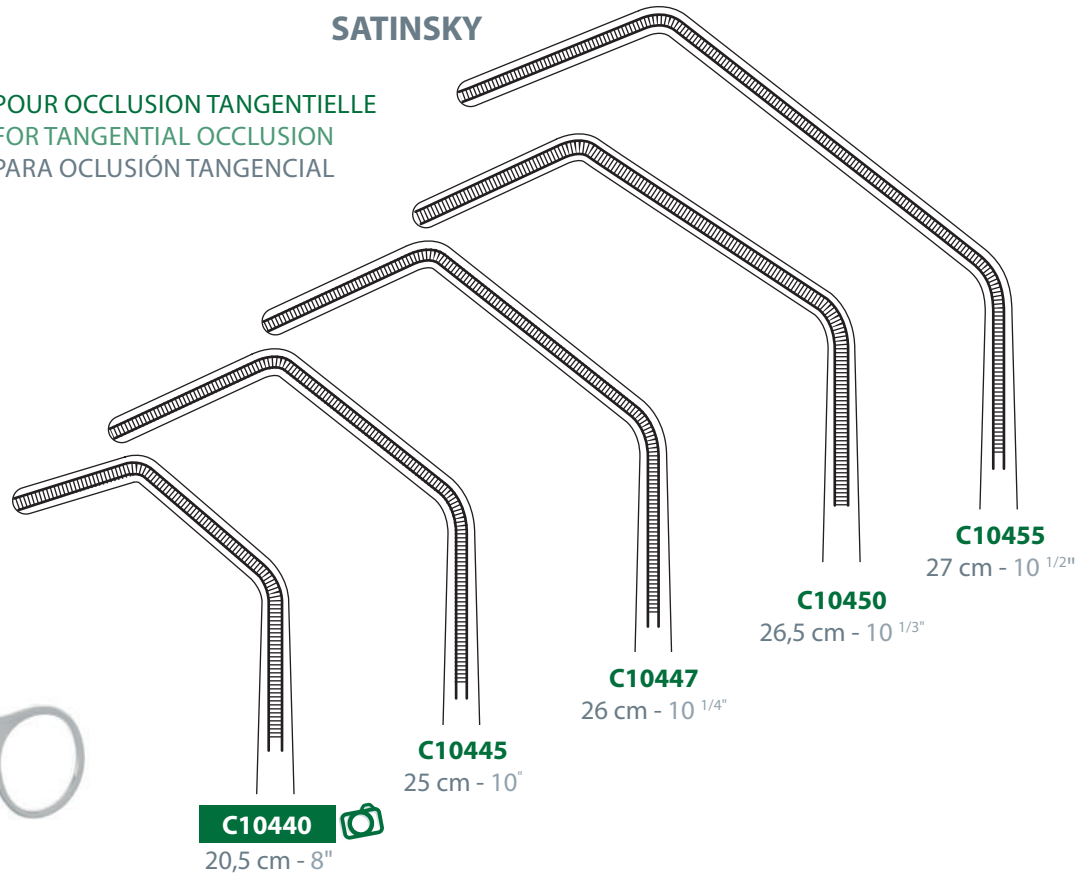

C10440 
20,5 cm - 8"

C10445
25 cm - 10"

C10447
26 cm - 10 1/4"

C10450
26,5 cm - 10 1/3"

C10455
27 cm - 10 1/2"

LAMBERT KAY

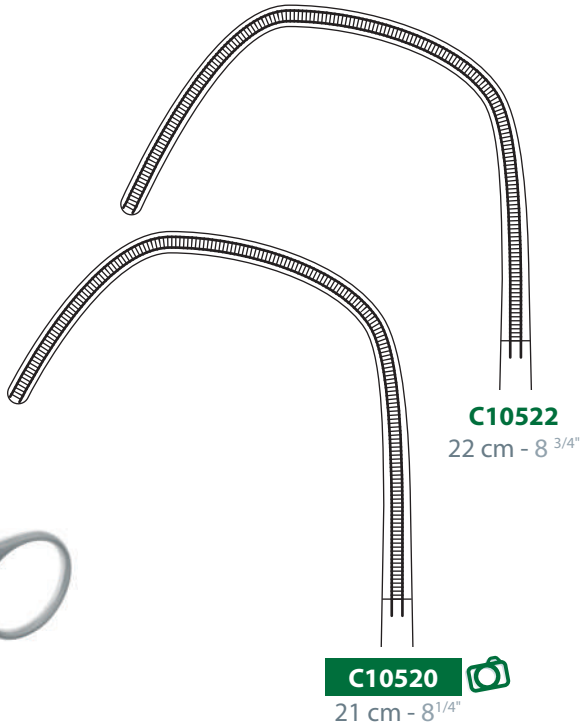

C10520 
21 cm - 8 1/4"

C10522
22 cm - 8 3/4"

DEBAKEY



C10525
17 cm - 6 3/4"

V - Clamps
V - Clamps
V - Clamps



DeBakey

BECK

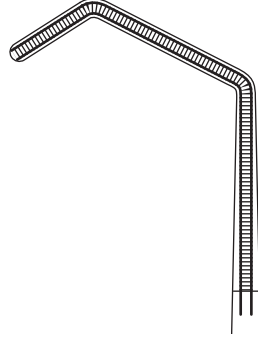

C10715
17 cm - 6 ³/₄"

DEBAKEY

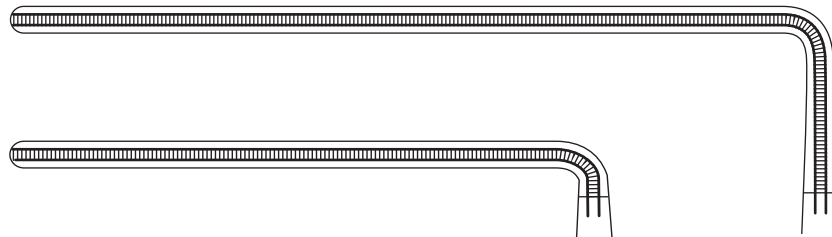
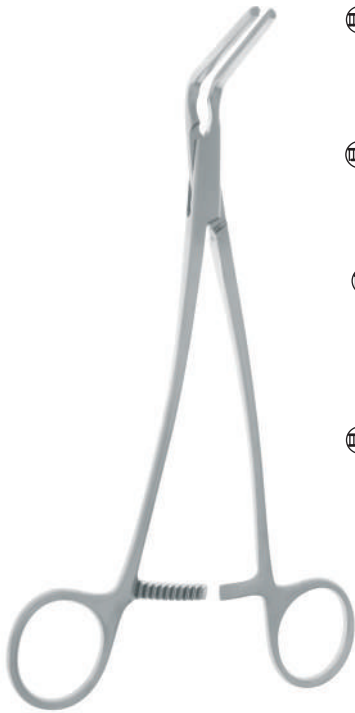

C10605
23 cm - 9"

C10610
27 cm - 10 ¹/₂"

C10600 
19 cm - 7 ¹/₂"

C10595
18 cm - 7"

V - Clamps
V - Clamps
V - Clamps



DeBakey

A USAGES MULTIPLES
FOR MULTI PURPOSE
PARA USOS VARIOS



DEBAKEY

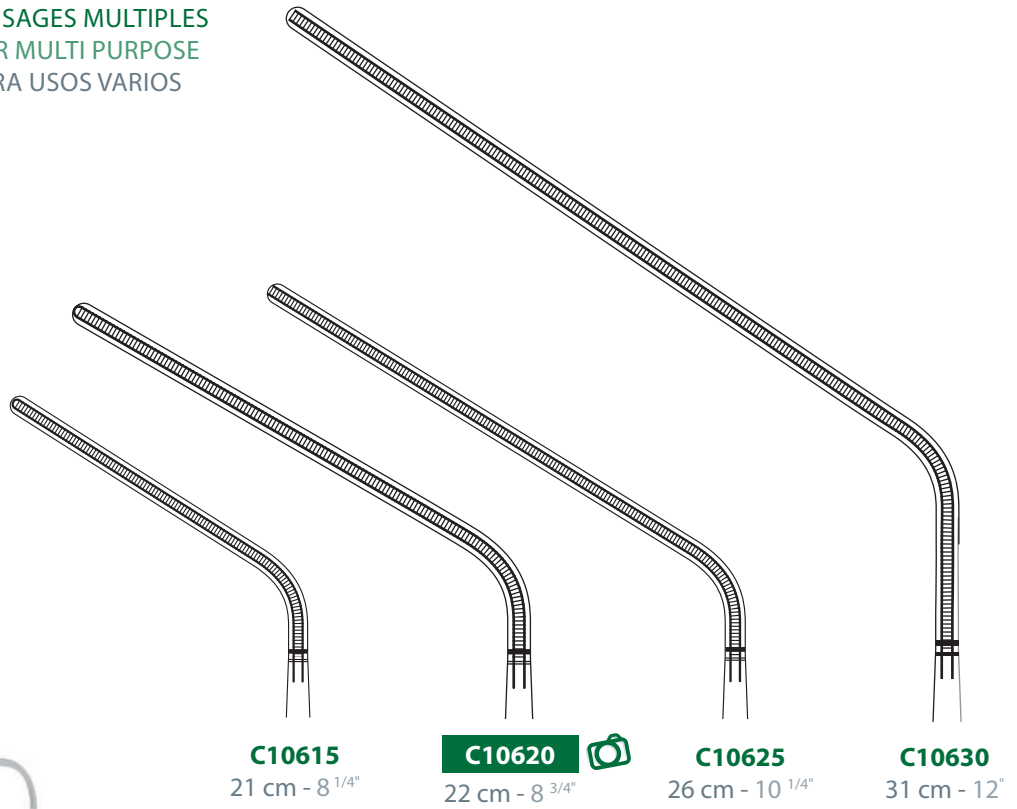

C10615
21 cm - 8 1/4"

C10620 
22 cm - 8 3/4"

C10625
26 cm - 10 1/4"

C10630
31 cm - 12"

MORRIS DEBAKEY

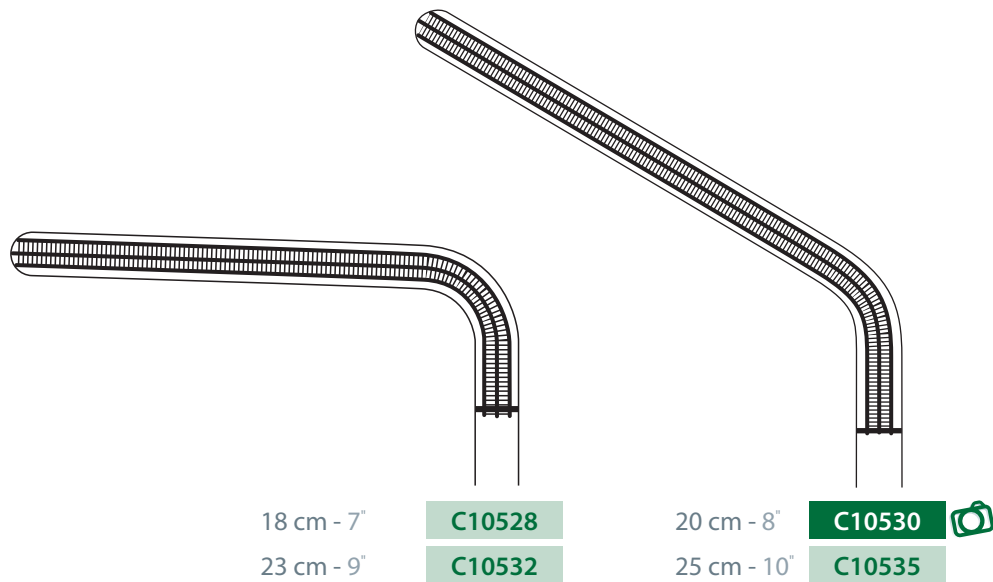

18 cm - 7"
23 cm - 9"

C10528
C10532

20 cm - 8"
25 cm - 10" 
C10530
C10535

V - Clamps
V - Clamps
V - Clamps



DeBakey

DEBAKEY BAHNSON

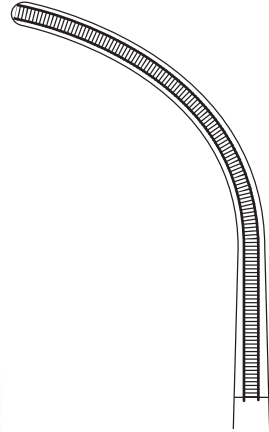

C10540 
26 cm - 10 ¹/₄"

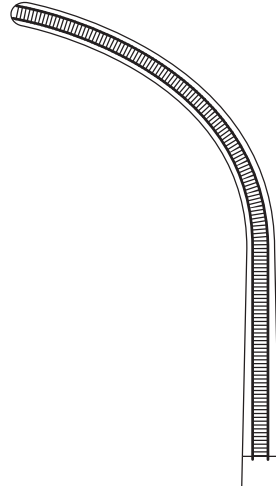

C10545
26,5 cm - 10 ¹/₃"

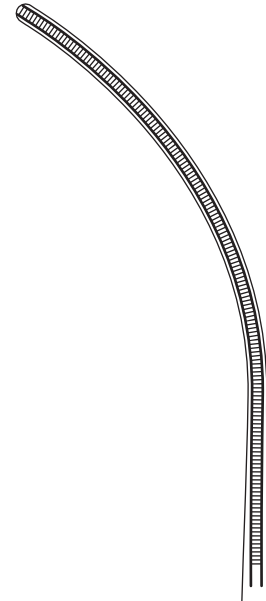

C10550
28,5 cm - 11 ¹/₄"

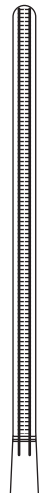

C10555 
21,5 cm - 8 ¹/₂"

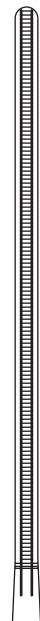

C10560
23 cm - 9"

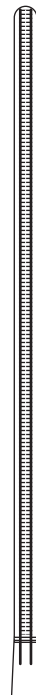

C10565
27 cm - 10 ¹/₂"

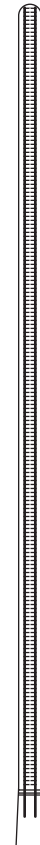

C10570
31,5 cm - 12 ¹/₂"

Pinces clamps vasculaires atrauma - Atrauma vascular forceps - Pinzas clamps vasculares atrauma



DeBakey



C10575 
21 cm - 8 1/4"

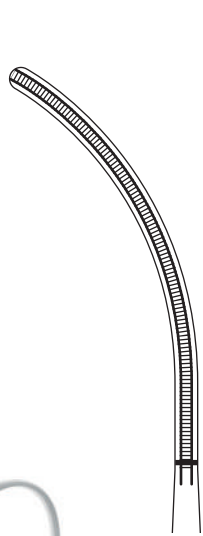

C10580
23 cm - 9"

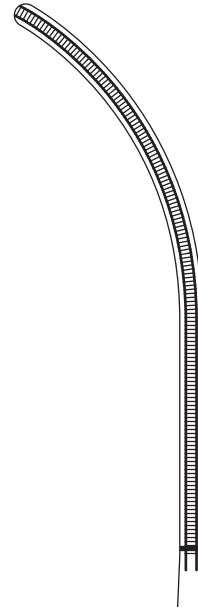

C10585
26 cm - 10 1/4"

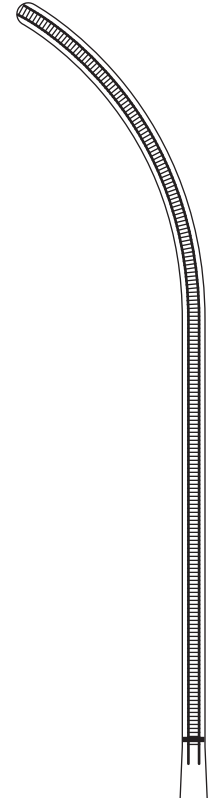

C10590
31 cm - 12 1/4"

DEBAKEY PEAN

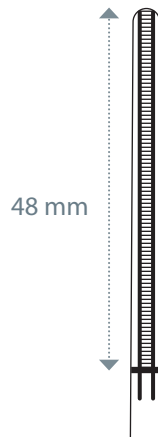

14 cm - 5 1/2"	C10640	38 mm
16 cm - 6 1/4"	C10641	44 mm
18 cm - 7"	C10642 	48 mm
20 cm - 8"	C10643	50 mm

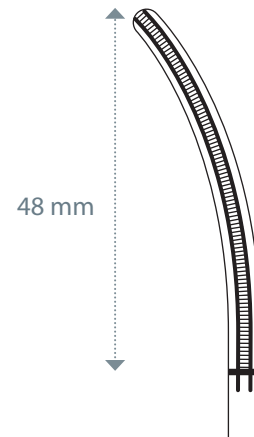

14 cm - 5 1/2"	C10650	38 mm
16 cm - 6 1/4"	C10651	44 mm
18 cm - 7"	C10652	48 mm
20 cm - 8"	C10653	50 mm

V - Clamps
V - Clamps
V - Clamps



DeBakey

DEBAKEY RANKIN

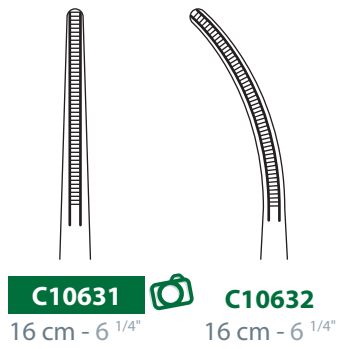

C10631
16 cm - 6 1/4"

C10632
16 cm - 6 1/4"

DEBAKEY MOSQUITO

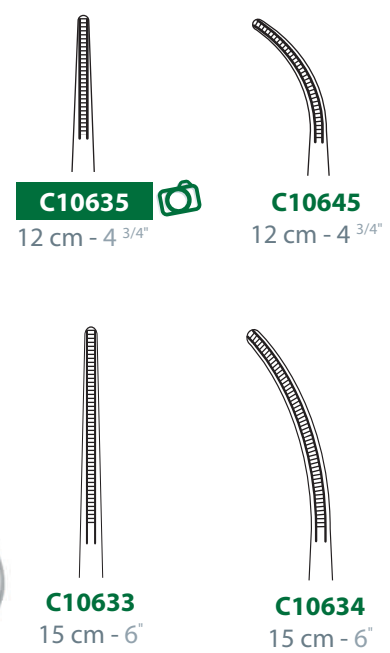

C10635
12 cm - 4 3/4"

C10645
12 cm - 4 3/4"

C10633
15 cm - 6"

C10634
15 cm - 6"

DEBAKEY

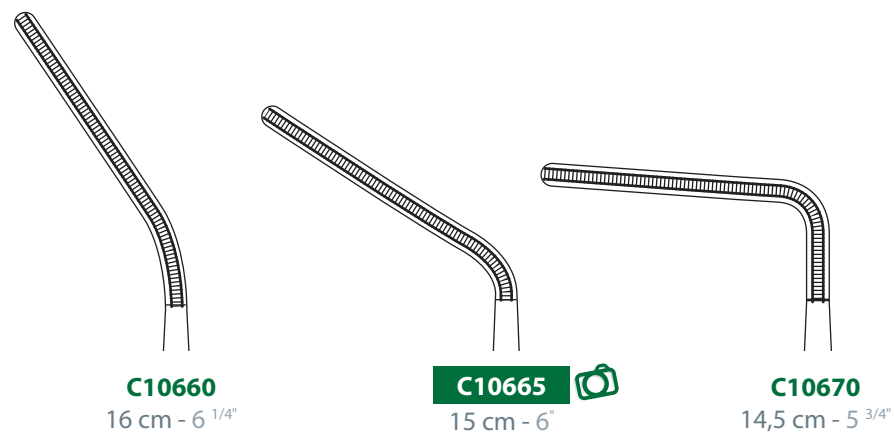

C10660
16 cm - 6 1/4"

C10665
15 cm - 6"

C10670
14,5 cm - 5 3/4"

V - Clamps
V - Clamps
V - Clamps



DeBakey

DEBAKEY



C10655
17 cm - 6 3/4"

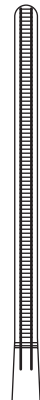

C10675
17 cm - 6 3/4"

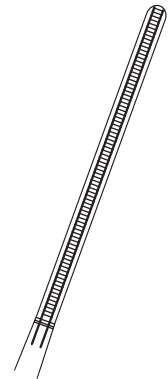

GLOVER



C10680
17 cm - 6 3/4"

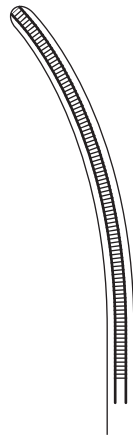

C10685
17 cm - 6 3/4"

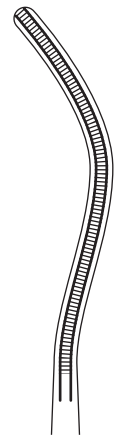

V - Clamps
V - Clamps
V - Clamps

LANDANGER

Pinces clamps vasculaires atrauma - Atrauma vascular forceps - Pinzas clamps vasculares atrauma



DeBakey



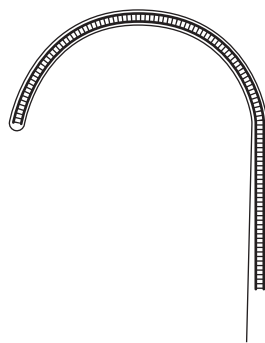

POUR LIGATURE
FOR LIGATURE
PARA LIGADURA

GLOVER

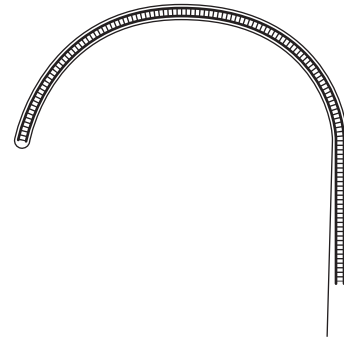

C10690
16 cm - 6 1/2"



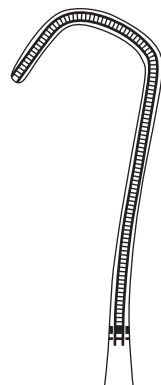

C10695 
16 cm - 6 1/2"

DERRA

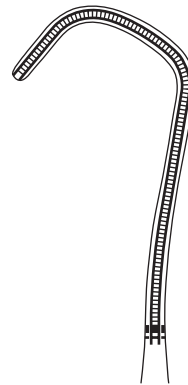

C10700
16 cm - 6 1/4"



C10705 
17 cm - 6 3/4"

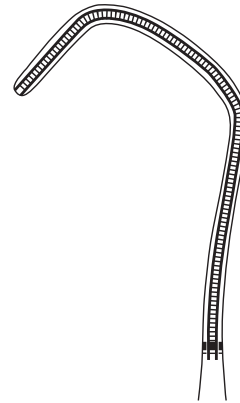

C10710
18 cm - 7"



DeBakey

DALE



PINCES-CLAMPS PÉRIPHÉRIQUES
PERIPHERAL VESSEL CLAMPS
PINZAS CLAMPS PERIFERICAS

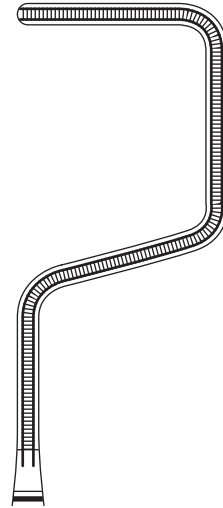

C10746
18,5 cm - 7 1/4"



C10748
17 cm - 6 3/4"

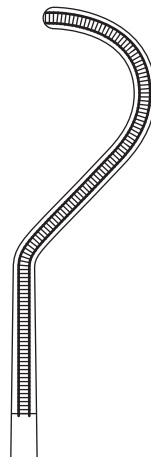

C10749 
17,5 cm - 6 4/5"

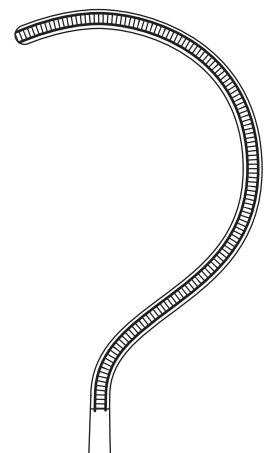
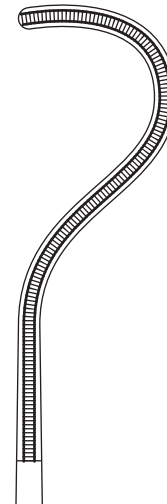

C10751
18,5 cm - 7 1/4"

V - Clamps
V - Clamps
V - Clamps



DeBakey

GREGORY

POUR LA PROFONDEUR
PROFUNDA CLAMPS
PARA LA PROFUNDIDAD

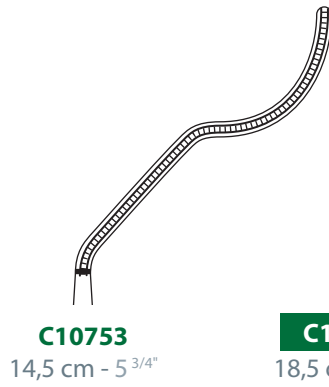

C10753
14,5 cm - 5 ³/₄"

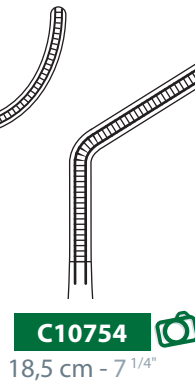

C10754 
18,5 cm - 7 ¹/₄"

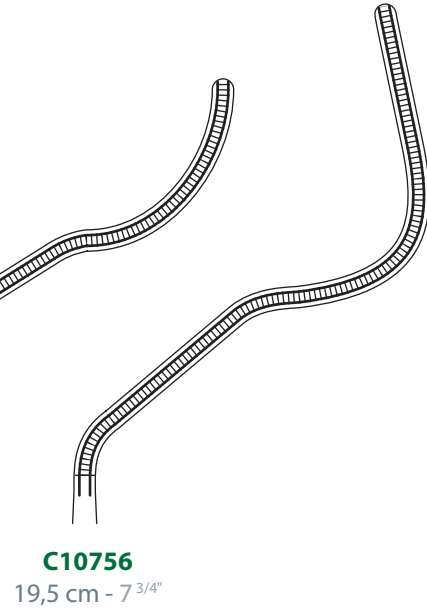

C10756
19,5 cm - 7 ³/₄"

SUBRAMANIAN



C11005
15,5 cm - 6"

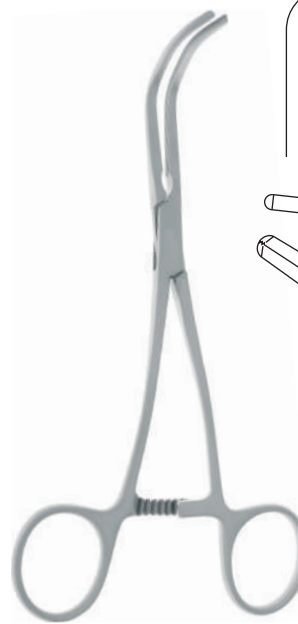
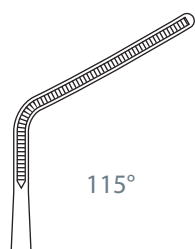

C11015 
16 cm - 6 ¹/₄"

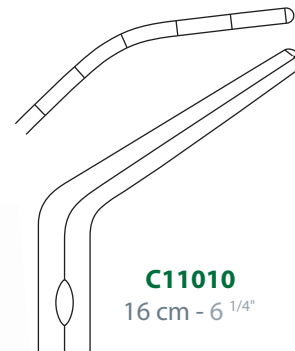

C11010
16 cm - 6 ¹/₄"

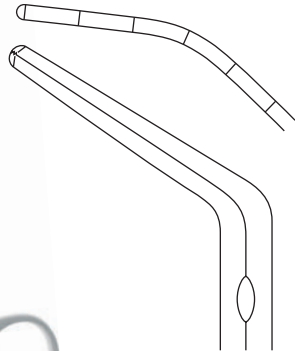

V - Clamps
V - Clamps
V - Clamps



DeBakey

DEBAKEY

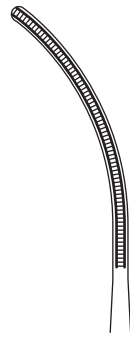

C10720
11 cm - 4 1/4"



C10725
10 cm - 4"

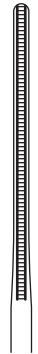

C10730 
12 cm - 4 3/4"

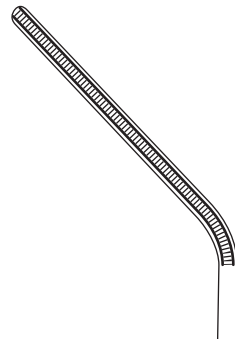

C10740
13 cm - 5"

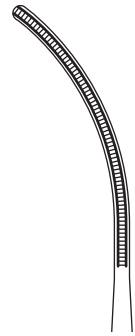

C10735
12 cm - 4 3/4"

JAVID



POUR LA CAROTIDE
FOR CAROTID
PARA LA CAROTIDA

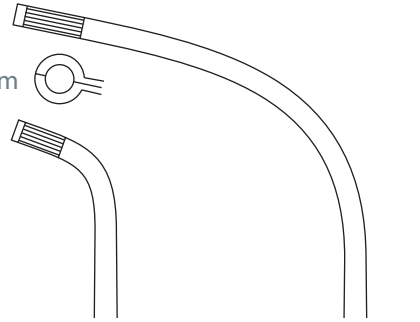

C10772

16 cm - 6 1/4"

C10774

19 cm - 7 1/2"



Cooley

24 CH	16 cm - 6 1/4"	C10758
26 CH	16 cm - 6 1/4"	C10759
28 CH	19 cm - 7 1/2"	C10761
30 CH	19 cm - 7 1/2"	C10762
32 CH	19 cm - 7 1/2"	C10763
36 CH	19 cm - 7 1/2"	C10764

COOLEY



Ø 10,7 mm

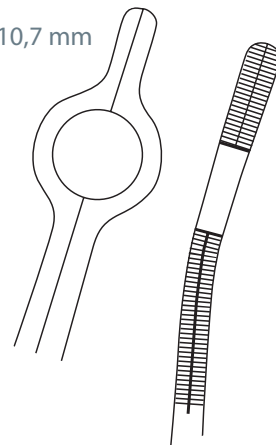



Cooley

BECK

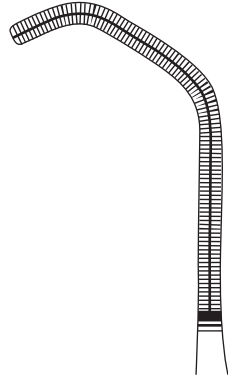

C10785
17 cm - 6 3/4"

COOLEY-DERRA

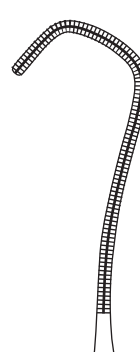

C10830 
16 cm - 6 1/4"

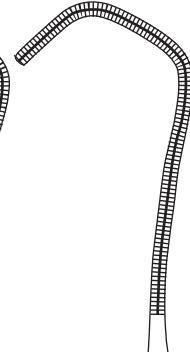

C10835
17 cm - 6 3/4"

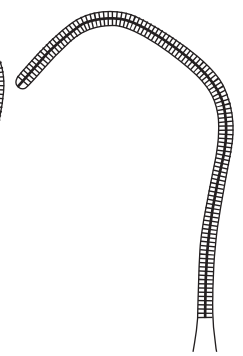

C10840
18 cm - 7"

COOLEY

A USAGES MULTIPLES
FOR MULTI-PURPOSE
PARA USOS VARIOS

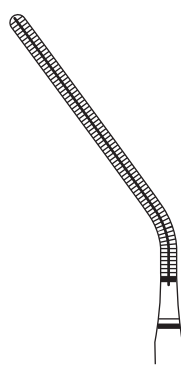

C10800
17 cm - 6 3/4"

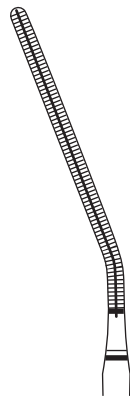

C108020
17 cm - 6 3/4"

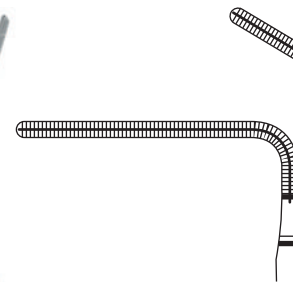

C10790
13,5 cm - 5 1/4"

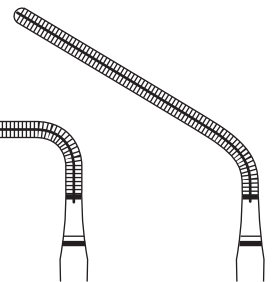

C10795 
15,5 cm - 6 1/8"



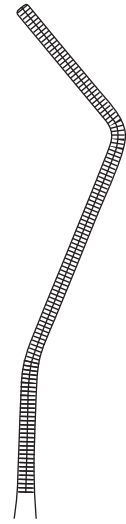

Cooley

COOLEY

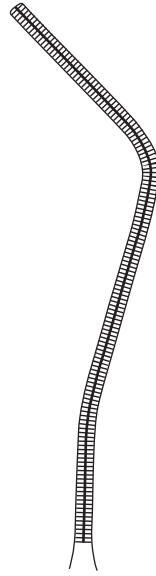

C107790
18 cm - 7"



C10780 
20 cm - 8"

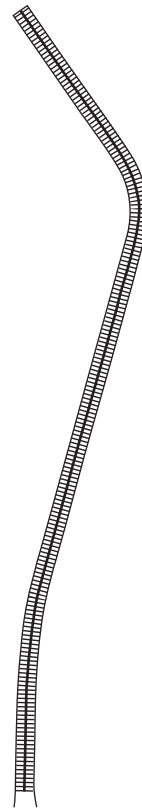

C107810
29 cm - 11 1/2"

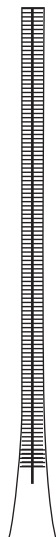

C108410
21,5 cm - 8 1/2"



Cooley

COOLEY

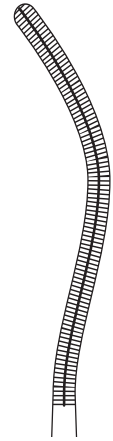

C10775
17 cm - 6 3/4"

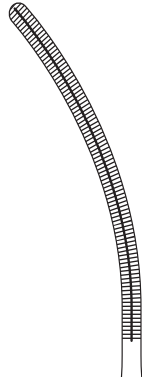

C10805
17 cm - 6 3/4"



C10810

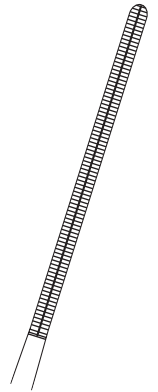

C10815
17 cm - 6 3/4"

POUR LIGATURE
FOR LIGATURE
PARA LIGADURA

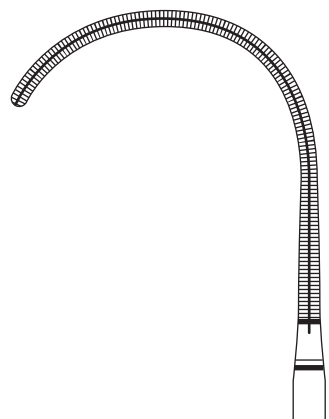

C10820
16 cm - 6 1/4"

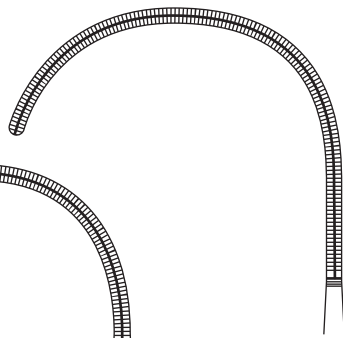

C10825
17 cm - 6 3/4"

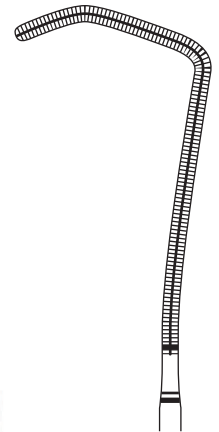

C10842
17 cm - 6 3/4"

V - Clamps
V - Clamps
V - Clamps

Pinces clamps vasculaires atrauma - Atrauma vascular forceps - Pinzas clamps vasculares atrauma



Cooley

COOLEY

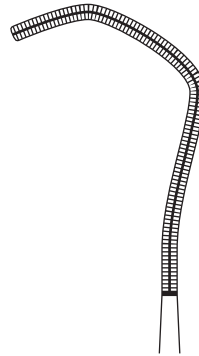

C10845
16 cm - 6 1/4"

Pinces clamps nouveau né et pédiatrique - Neonatal and pediatric clamps - Pinzas clamps para recién nacidos y pediátrico

COOLEY

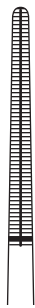

C11020 
14 cm - 5 1/2"

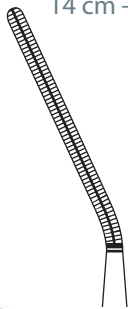

C11025
14 cm - 5 1/2"

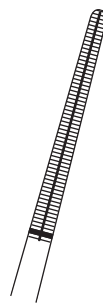

C11030
14 cm - 5 1/2"

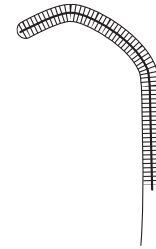

C11035 
14 cm - 5 1/2"



C11040
14 cm - 5 1/2"

V - Clamps
V - Clamps
V - Clamps



Cooley

COOLEY

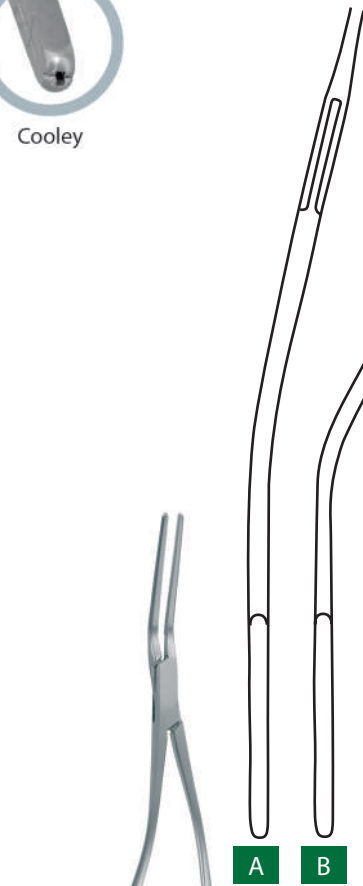

A B

15 cm - 6"

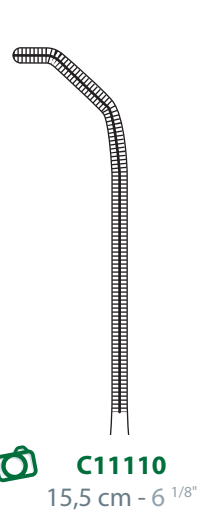
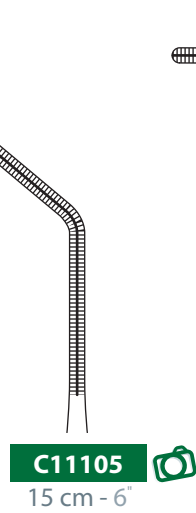
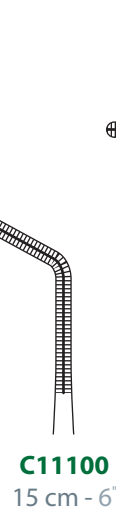
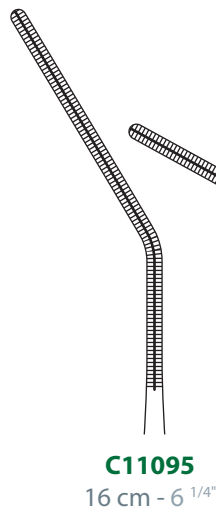
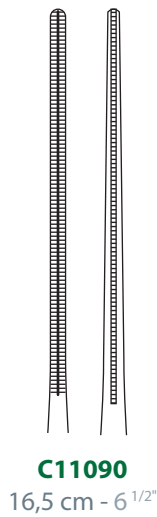
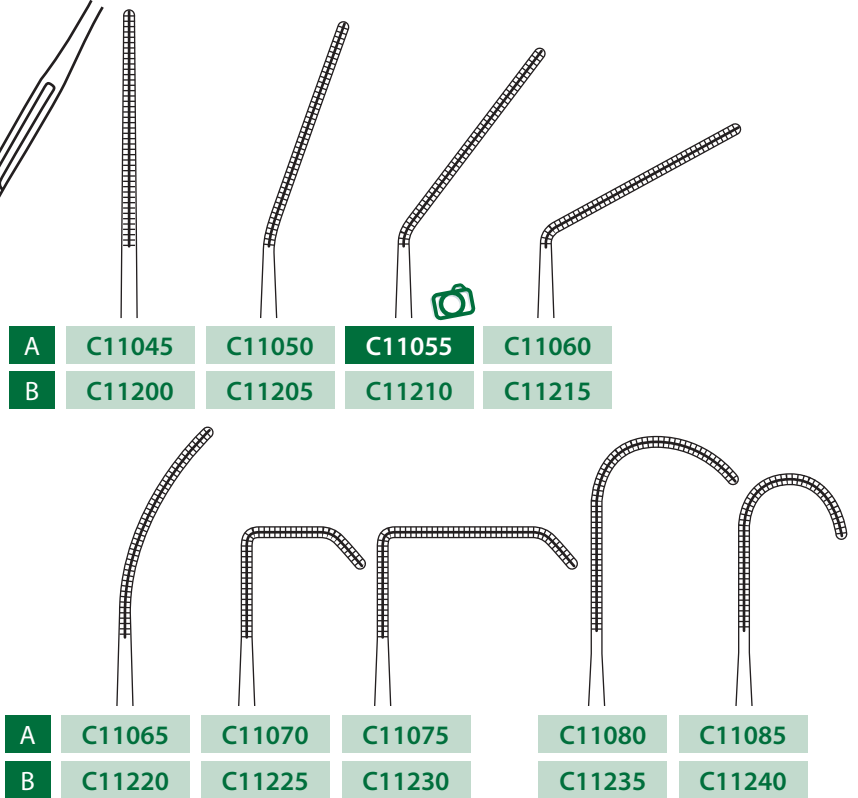

CASTANEDA

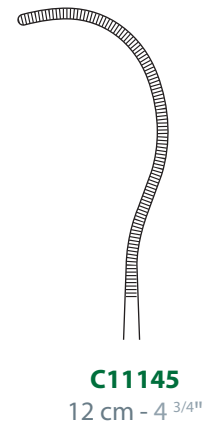
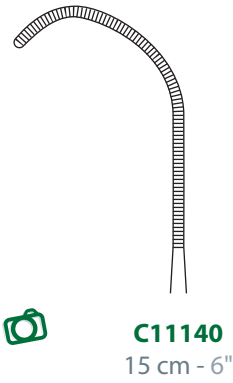
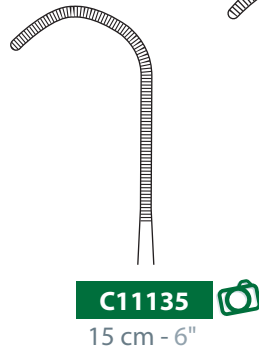
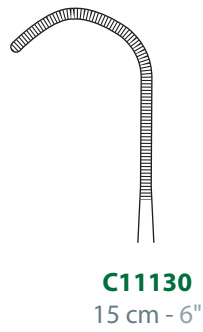
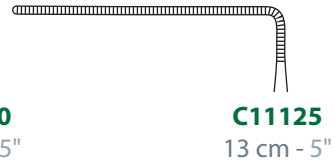
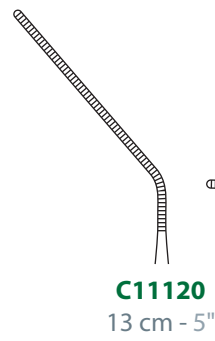
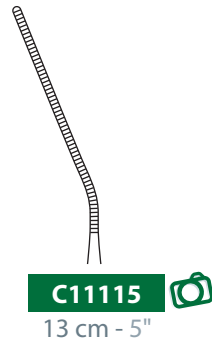

V - Clamps
V - Clamps
V - Clamps

DEBAKEY

19 cm - 7 1/2"	35 cm - 14"
C120005 Ø 0,5 mm	-
C120010 Ø 1,0 mm	C120110
C120015 Ø 1,5 mm	C120115
C120020 Ø 2,0 mm	C120120
C120025 Ø 2,5 mm	C120125
C120030 Ø 3,0 mm	C120130
C120035 Ø 3,5 mm	C120135
C120040 Ø 4,0 mm	C120140
C120045 Ø 4,5 mm	C120145
C120050 Ø 5,0 mm	C120150
C120070 Ø 7,0 mm	C120170
C120090 Ø 9,0 mm	C120190

COOLEY

13 cm - 5"
Ø 0,5 mm C120205
Ø 1,0 mm C120210
Ø 1,5 mm C120215
Ø 2,0 mm C120220
Ø 2,5 mm C120225 
Ø 3,0 mm C120230
Ø 4,0 mm C120240
Ø 5,0 mm C120250



C120040
19 cm - 7 1/2"



TUBBS

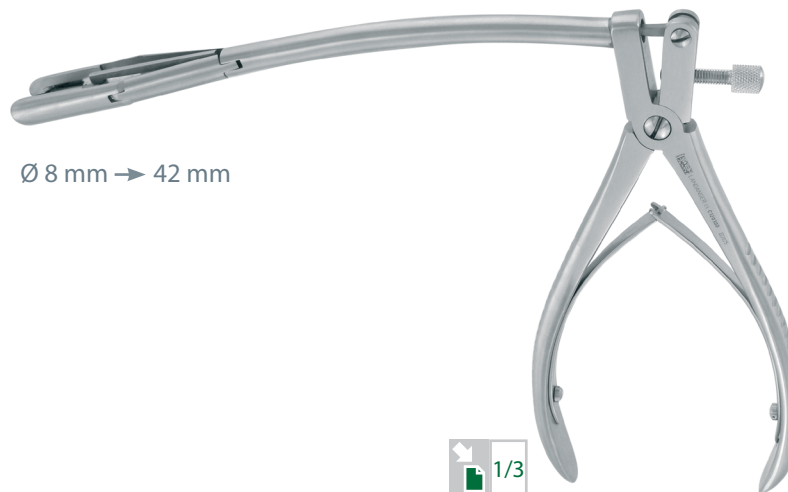

Ø 8 mm → 42 mm



C120300
16 cm - 6 1/4"



C120225
13 cm - 5 1/2"



Instruments à sutures - Suture instruments - Instrumentos de sutura

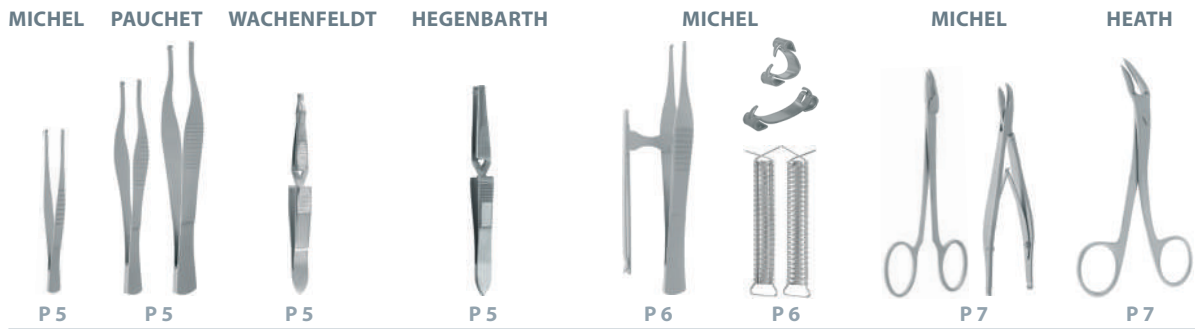

Porte-aiguilles - Needle holders - Porta agujas

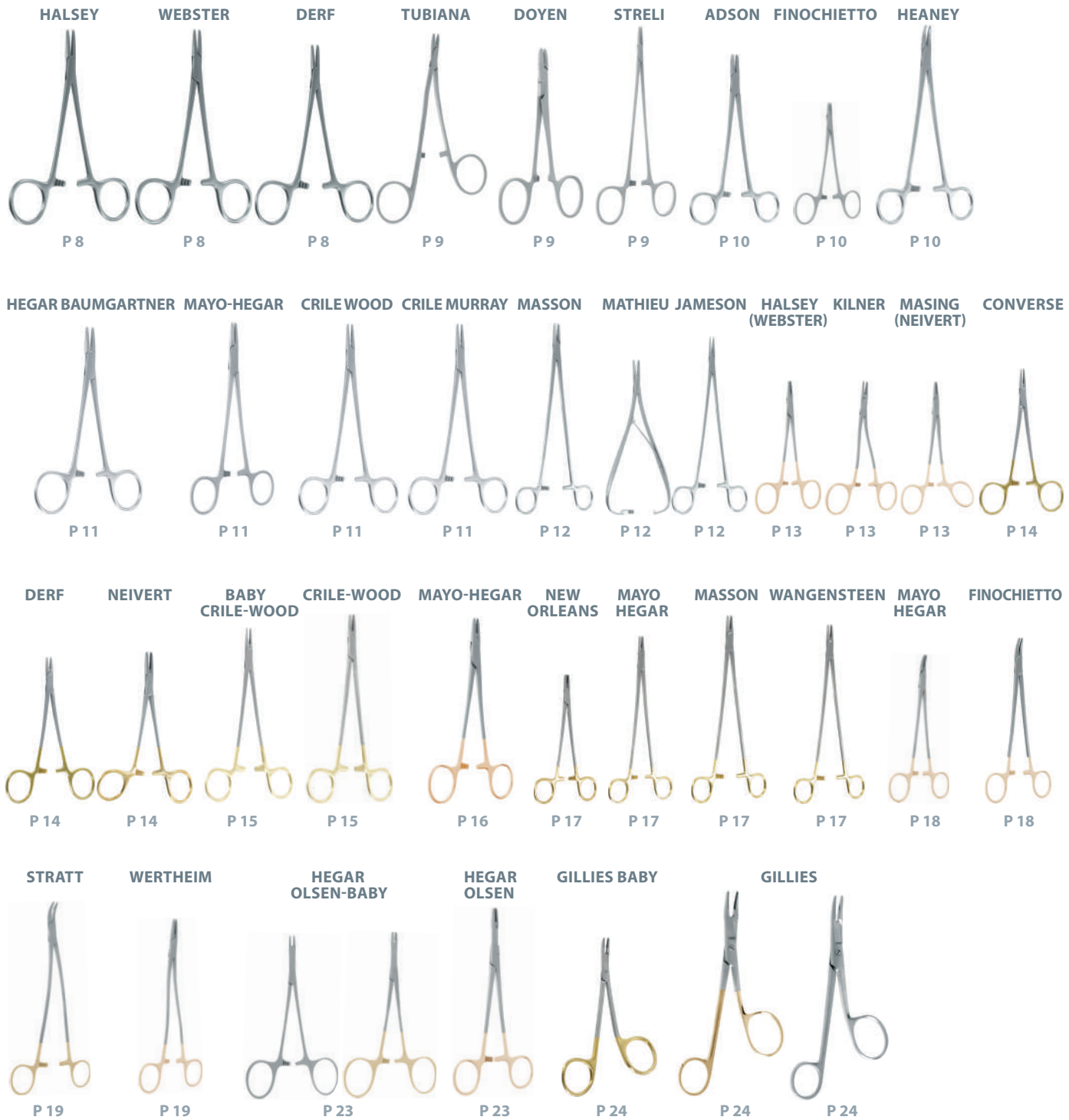

VI - Sutures
VI - Sutures
VI - Sutura

Porte-aiguilles - Needle holders - Porta agujas

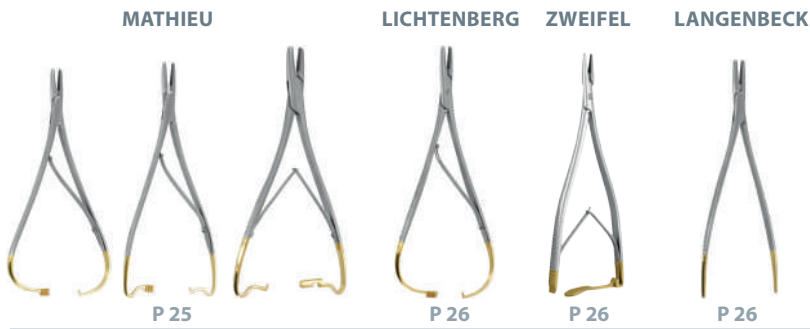

Porte-aiguilles vasculaires - Vascular needle holders - Porta agujas vasculares



Aiguilles à sutures - Suture needles - Agujas de sutura

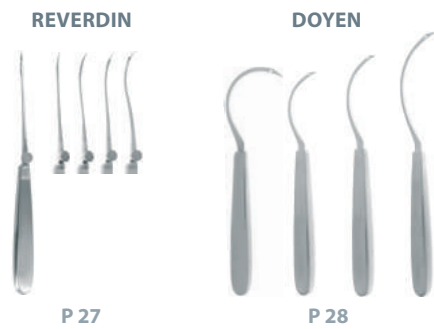

Aiguilles à ligatures - Ligature needles - Agujas para ligaduras

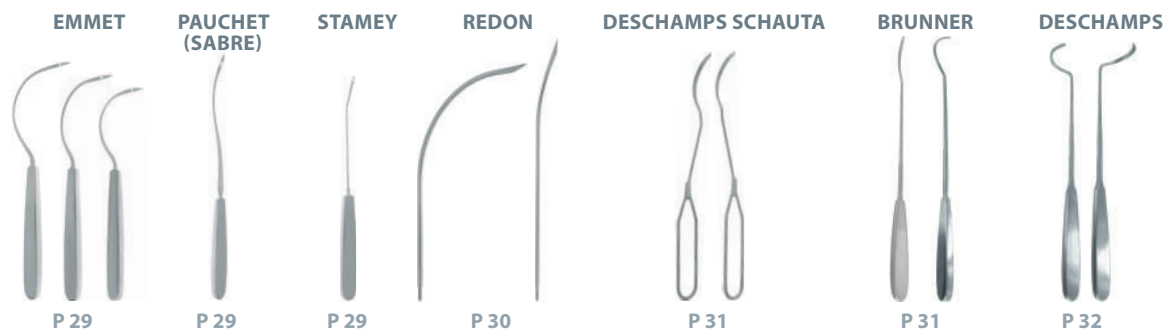

Instruments à ligatures - Ligature instruments - Instrumentos para ligaduras

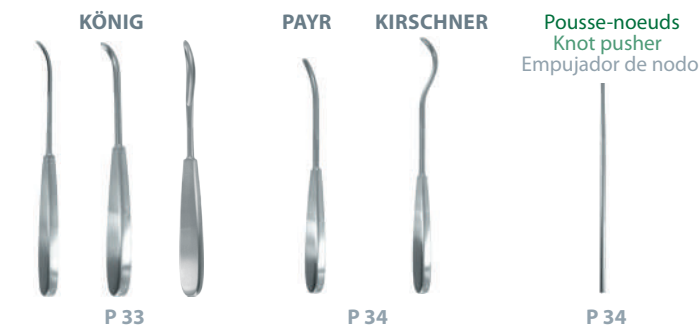

Microchirurgie porte-aiguilles - Microsurgery needle-holders - Microcirugía porta-agujas

X - Microchirurgie
X - Microsurgery
X - Microcirugía



Instrumentation de service - Instrumentation for services - Instrumentación de servicio

XV - Divers
XV - Miscellaneous
XV - Diversos



VI - Sutures
VI - Sutures
VI - Sutura

MICHEL

PAUCHET

WACHENFELDT

HEGENBARTH

Pinces à poser les agrafes
Clip applying forceps
Pinzas para poner las grapas

Pour agrafes 7,5 mm
For clips 7,5 mm
Para grapas 7,5 mm



G25010
10 cm - 4"



G25020
13 cm - 5"



G25030
16 cm - 6 1/4"



G25040
12 cm - 4 3/4"



G250410
12,5 cm - 5"



MICHEL

Pour agrafes
For clips
Para grapas

7,5 mm - 9/32"	G25135 
12 mm - 15/32"	G25140
14 mm - 9/16"	G25150
16 mm - 5/8"	G25160

Pincas à affronter avec magasin fixe
Clip applying forceps with fixed magazine
Pinzas para tener con deposito fijo



G25135
14 cm - 5 1/2"

Boite de 1000
Box of 1000
Caja de 1000

7,5 mm x 1.75mm	G254707
12 mm x 2.5 mm	G254712 
14 mm x 3.0 mm	G254714
16 mm x 3.0 mm	G254716
18 mm x 3.0 mm	G254718
20 mm x 3.0 mm	G254720



Agrafes de Michel
Michel suture clips
Grapas de Michel

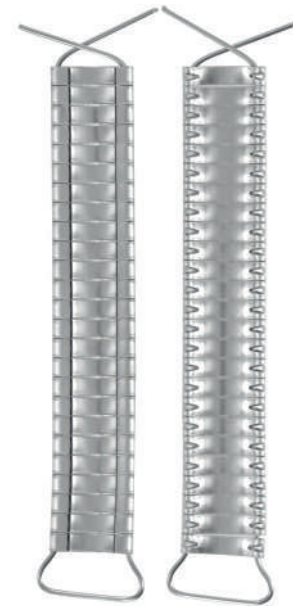

G254712
12 mm

MICHEL

HEATH

Pinces à retirer les agrafes
Clip removing forceps
Pinzas para retirar las grapas

Double usage
Applying and removing
Uso doble

A doigts
Collin's lock
Desmontables



G25050
13 cm - 5"



G25080
12 cm - 4 3/4"



G25060
14 cm - 5 1/2"

HALSEY

Mors lisses
Smooth jaws
Boccas lisas

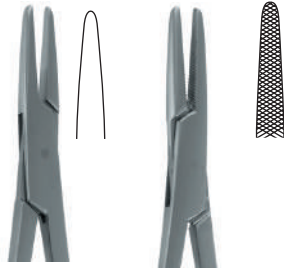

G300200
13 cm - 5"



G300205
13 cm - 5"

WEBSTER

Mors lisses
Smooth jaws
Boccas lisas



G300220
13 cm - 5"

DERF



G300210
12 cm - 4 ³/₄"



G300215
12,5 cm - 5"

TUBIANA

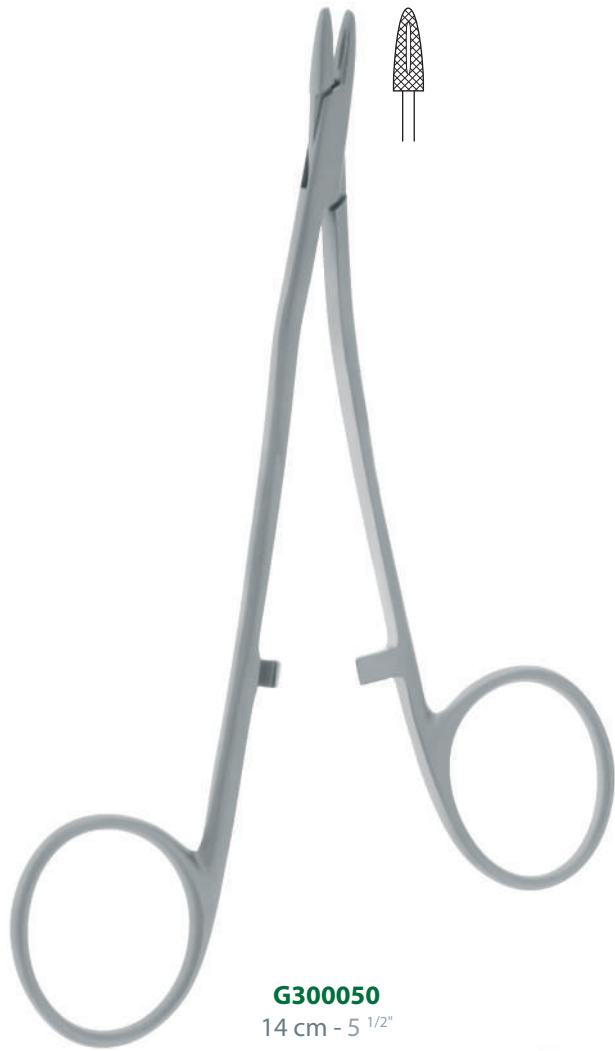

G300050
14 cm - 5 1/2"

DOYEN

A doigt
Collin's lock
Desmontable

G30010 
13 cm - 5"

Branches passées
Box lock
Indesmontable

G300150
13 cm - 5"



G30010
13 cm - 5"

STRELI



G30080
15 cm - 6"

Porte-aiguilles - Needle holders - Porta agujas

ADSON

FINOCHIETTO

HEANEY



G30060
17 cm - 6 3/4"



G30070
20 cm - 8"



G30050
13 cm - 5 1/8"



G300230
18 cm - 7"



G300240
20,5 cm - 8"

VI - Sutures
VI - Sutures
VI - Sutura

MAYO-HEGAR

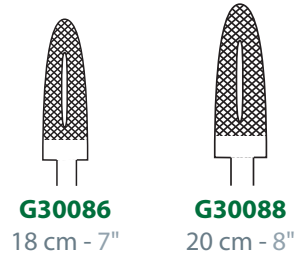
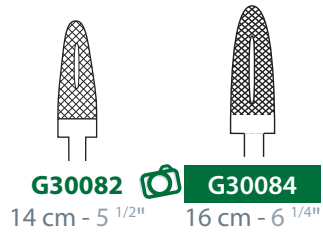

CRILE WOOD

CRILE MURRAY



G300810



HEGAR BAUMGARTNER

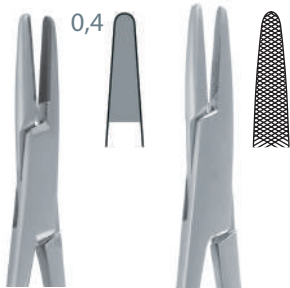

G300895
 14 cm - 5 1/2"



MASSON

MATHIEU

JAMESON



G300260
26,5 cm - 10^{1/2}"

G300310
20 cm - 8"

14 cm - 5^{1/2}"

G300300

17 cm - 6^{3/4}"

G300305

20 cm - 8"

G300310



G300250
23 cm - 9"



TC Inserts

KILNER

0,4



HALSEY (WEBSTER)

Mors lisses
Smooth jaws
Bocas lisas



MASING (NEIVERT)

0,3



G30158
13 cm - 5"

Anneau décalé
Juted ring
Anillo decalado

G30151
13 cm - 5"

G30159
13 cm - 5"





TC Inserts

DERF

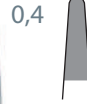

CONVERSE

NEIVERT

2 anneaux décalés
2 rings juted
2 anillos decalados



G300891
12,5 cm - 5"



G300892
12,5 cm - 5"



G300893
13 cm - 5"

LANDANGER

Porte-aiguilles - Needle holders - Porta agujas



TC Inserts

CRILE-WOOD

13 cm - 5"	G30090		
15 cm - 6"	G30100	G30100L	L
18 cm - 7"	G30110	G30110L	L
20 cm - 8"	G30120	G30120L	L
23 cm - 9"	G30130		
26 cm - 10 1/4"	G30140		
30 cm - 11 3/4"	G30150		
35 cm - 13 3/4"	G301502		



Gaucher
Left-handed
Zurdo

BABY CRILE-WOOD

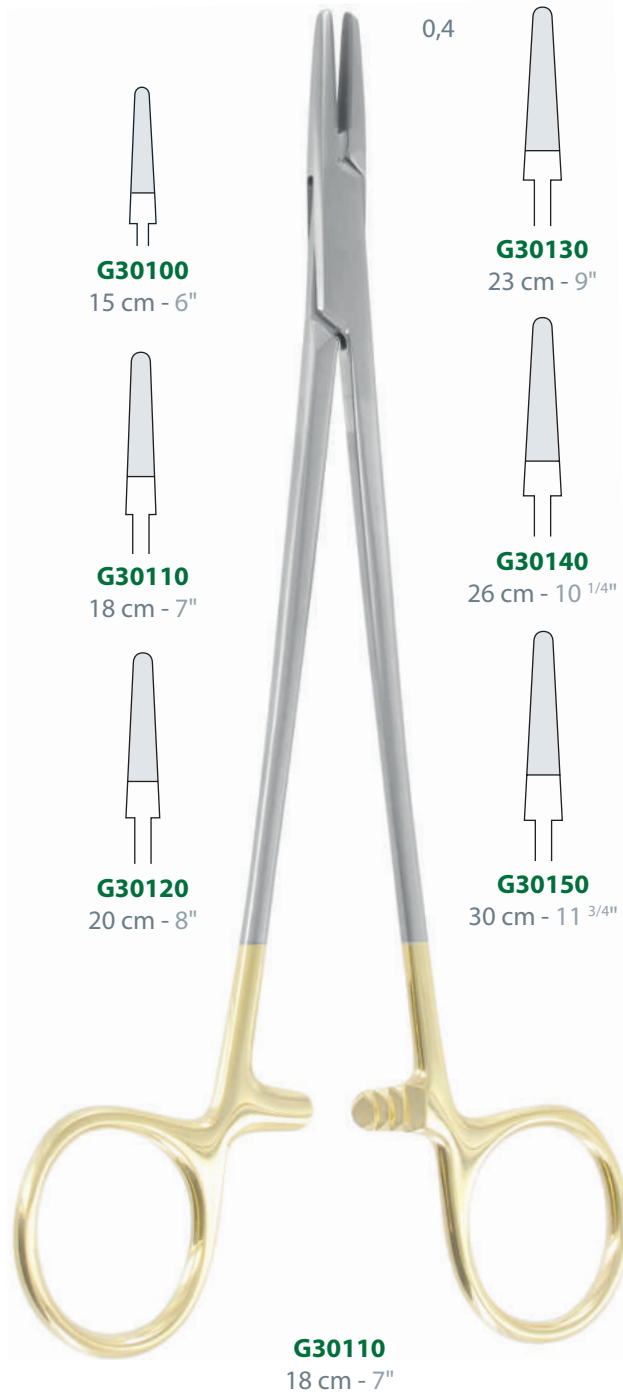

MAYO-HEGAR



TC Inserts

14 cm - 5 1/2"	G30210		
16 cm - 6 1/4"	G30220	G30220L	L
18 cm - 7"	G30230	G30230L	L
20 cm - 8"	G30240	G30240L	L
23 cm - 9"	G30250		
26 cm - 10 1/4"	G30260		
30 cm - 11 3/4"	G30270		



Gaucher
Left-handed
Zurdo

Droit
Straight
Recta

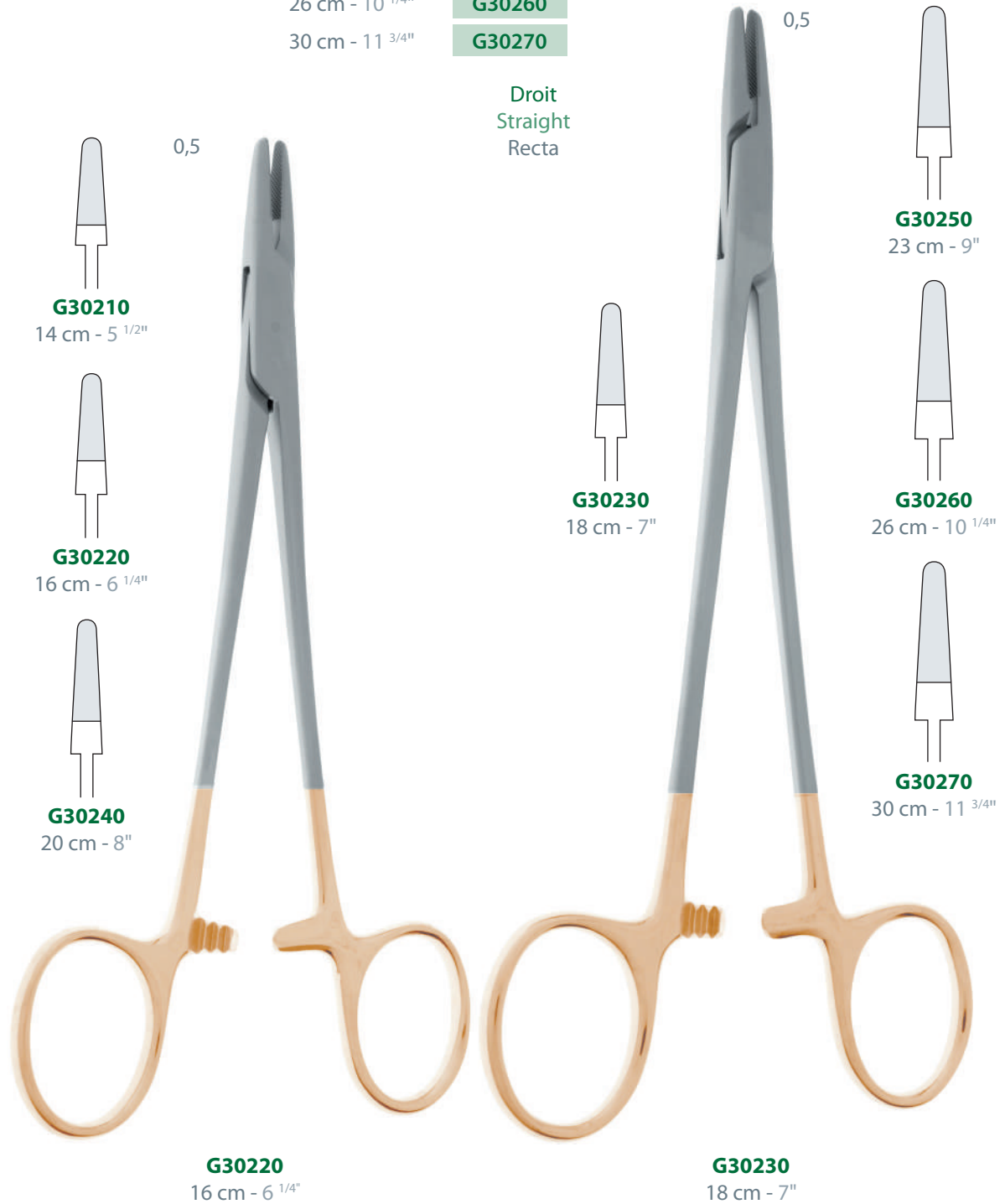

NEW ORLEANS



TC Inserts

0,5



G303290
18 cm - 7"

MAYO-HEGAR

G303300

G303301

Modèle robuste
Heavy pattern
Modelo robusto



G303301
24 cm - 9 1/2"

MASSON

0,5



G303310
27 cm - 10 1/2"

WANGENSTEEN

0,5



G303320
27 cm - 10 1/2"



G303320
27 cm - 10 1/2"

VI - Sutures
VI - Sutures
VI - Sutura



TC Inserts

MAYO-HEGAR

Courbe
Curved
Curva

- 18 cm - 7"
- 20 cm - 8"
- 23 cm - 9"
- 26 cm - 10 ¹/₄"

G30280

G30290

G30300

G30310

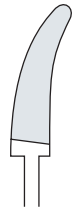

G30280
18 cm - 7"

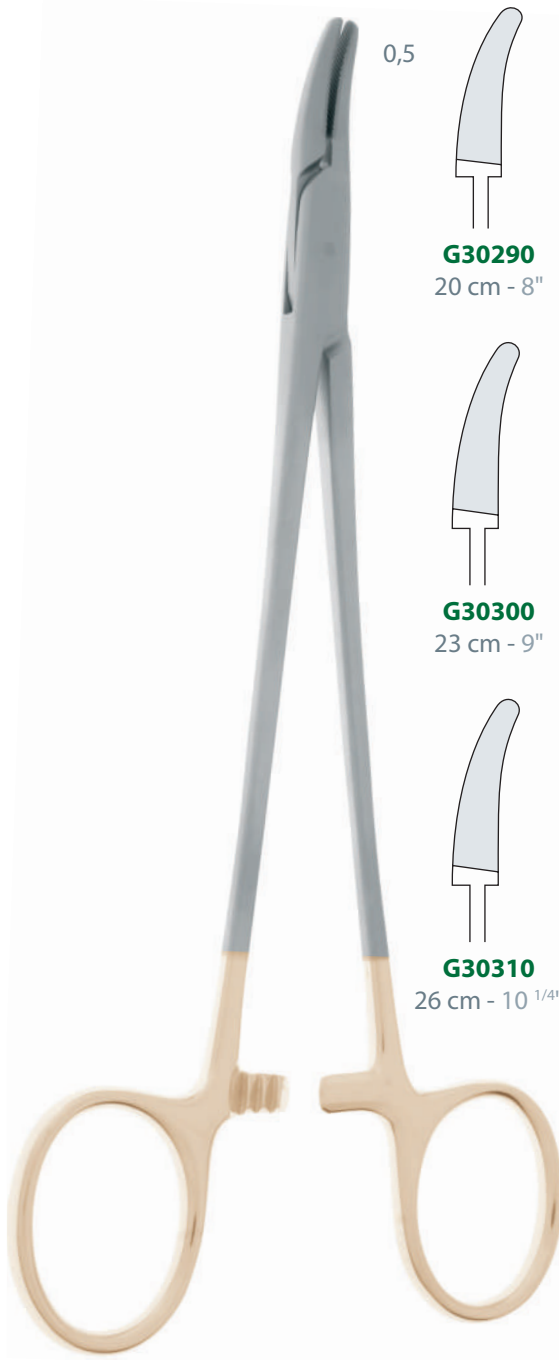

G30280
18 cm - 7"

0,5

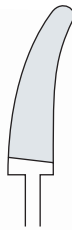

G30290
20 cm - 8"



G30300
23 cm - 9"



G30310
26 cm - 10 ¹/₄"

FINOCHIETTO

Courbe
Curved
Curva

- 20 cm - 8"
- 27 cm - 10 ¹/₂"

G303110

G303120



0,5

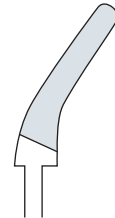

G303110
20 cm - 8"

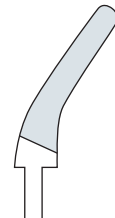

G303120
27 cm - 10 ¹/₂"



G303110
20 cm - 8"



STRATT



G30370
23 cm - 9"

**WERTHEIM
(BOZEMANN)**

20 cm - 8"

G30380



26 cm - 10^{1/4}"

G30390

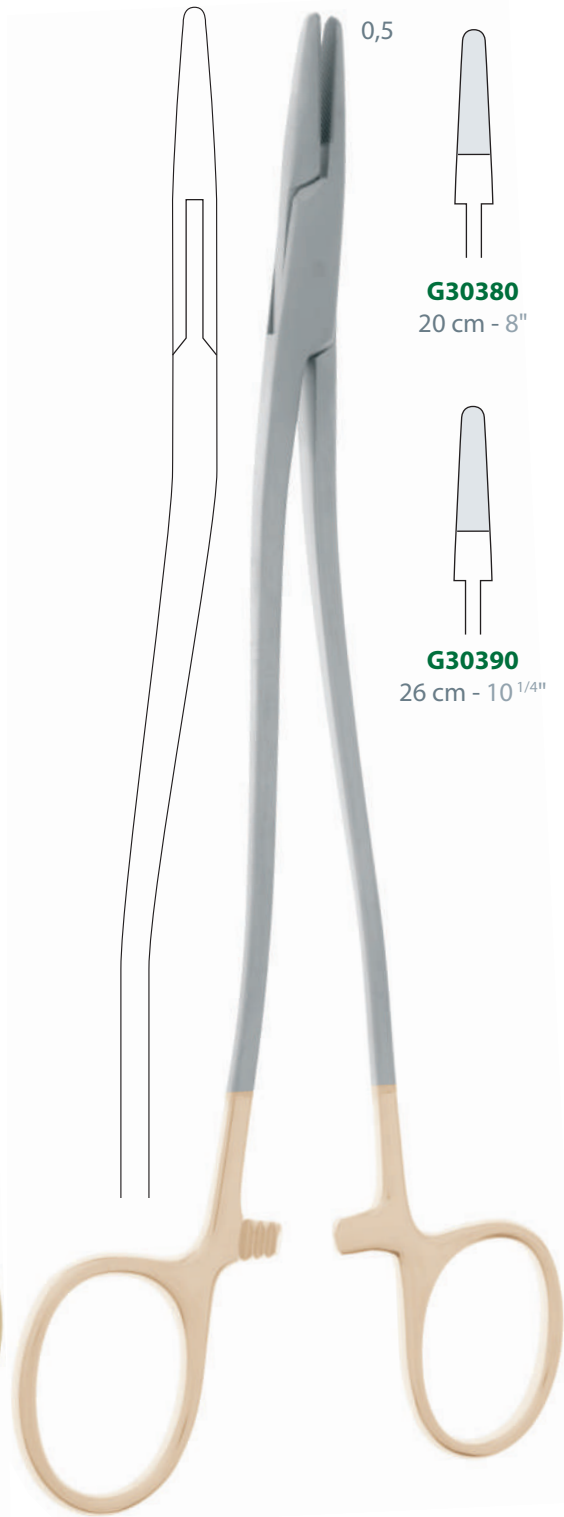

0,5



G30380
20 cm - 8"



G30390
26 cm - 10^{1/4}"

VI - Sutures
VI - Sutures
VI - Sutura

DEBAKEY



Gaucher
Left-handed
Zurdo

Handedness	Model	Length
L	G30152L	18 cm - 7"
L	G30153L	20 cm - 8"
L	G30154L	23 cm - 9"
		26 cm - 10 1/4"
		30 cm - 11 3/4"

Standard	Fin
Standard	Fine
Standard	Fino
G30152	G301521
G30153	G301531
G30154	G301541
G30155	G301551
G30156	G301561

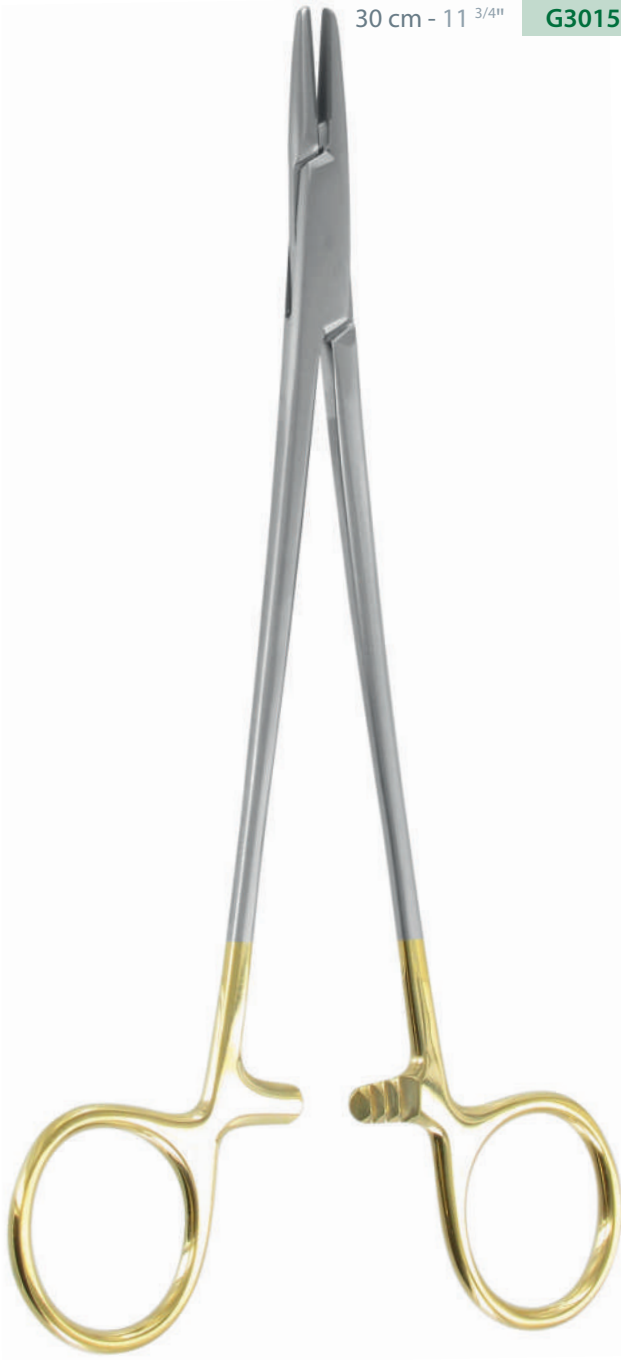

G30152
18 cm - 7"

0,4



G30152
18 cm - 7"



G30153
20 cm - 8"



G30154
23 cm - 9"



G30155
26 cm - 10 1/4"



G30156
30 cm - 11 3/4"

0,3



G301521
18 cm - 7"



G301531
20 cm - 8"



G301541
23 cm - 9"



G301551
26 cm - 10 1/4"



G301561
30 cm - 11 3/4"



Gaucher
Left-handed
Zurdo

L G30164L

L G30170L

RYDER

Mors
Jaws
Bocas

16 mm

18 mm

21 mm

22 mm

22 mm

23 mm

G30160

G30164

G30170

G30180

G30182

G30190

13 cm - 5"

15 cm - 6"

18 cm - 7"

20 cm - 8"

23 cm - 9"

26 cm - 10 1/4"

MICRO-RYDER

Mors
Jaws
Bocas

16 mm

18 mm

21 mm

22 mm

22 mm

23 mm

G301601

G301641

G301701

G301801

G301821

G301901



TC Inserts



G30170
18 cm - 7"

Porte-aiguilles vasculaires - Vascular needle holders - Porta agujas vasculares

SAROT

18 cm - 7" **G303210** 
 26 cm - 10 1/4" **G303215**



TC Inserts

EUFRATE

13 cm - 5" **G30440** 
 15 cm - 6" **G30450**
 20 cm - 8" **G30460**

HEGAR VASCULAR

14 cm - 5 1/2" **G303200**
 18 cm - 7" **G303201**
 20 cm - 8" **G303202** 
 23 cm - 9" **G303203**

Cardiovasculaire
 Cardiovascular
 Cardiovascular

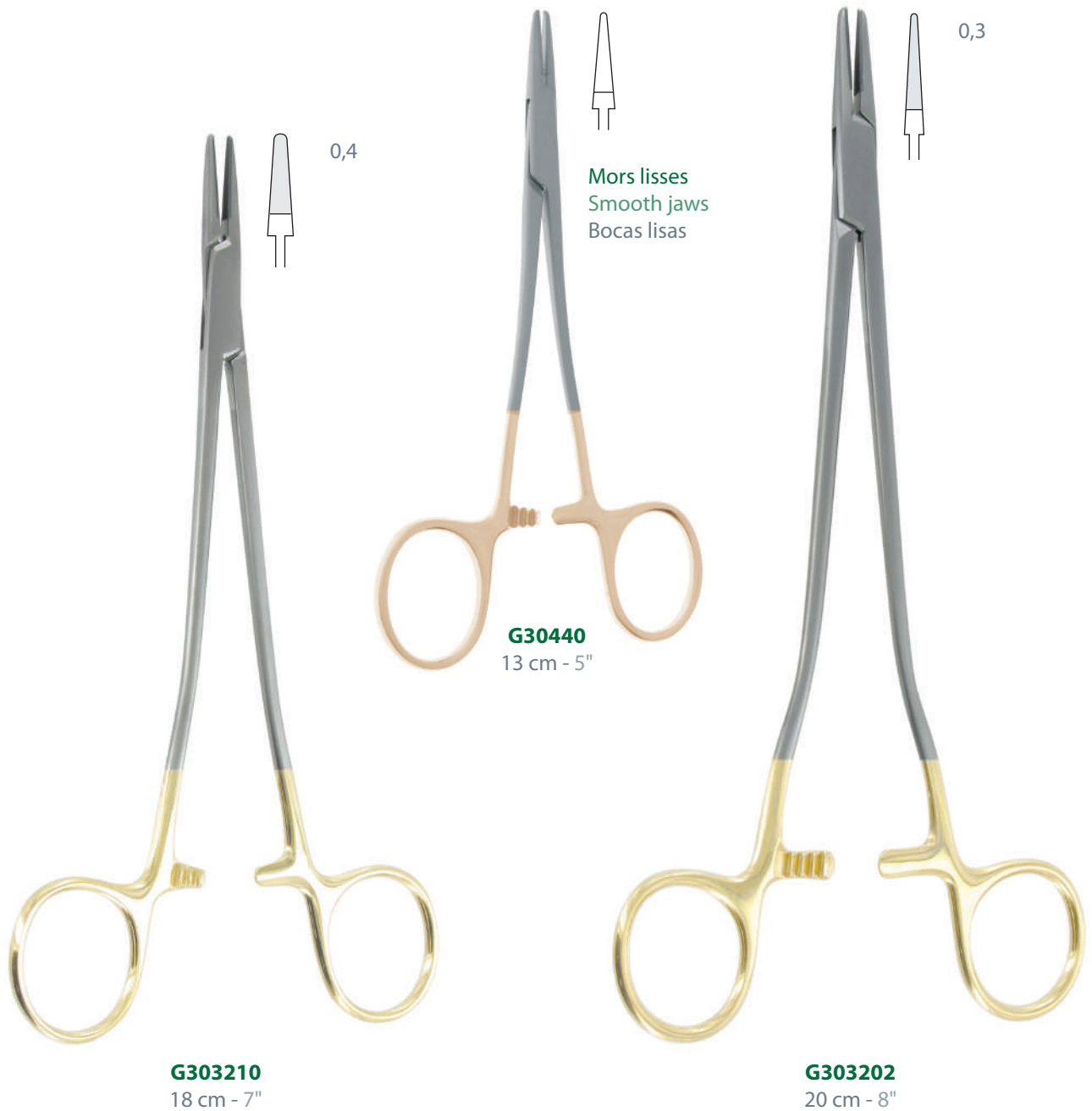

G303210
 18 cm - 7"

G30440
 13 cm - 5"

G303202
 20 cm - 8"

HEGAR-OLSEN-BABY

HEGAR-OLSEN

14 cm - 5 1/2"

G301990

G301950

16 cm - 6 1/4"

G30200



-

18 cm - 7"

-

G301960

Inox
Stainless steel
Aceno inoxidable

Inox
Stainless steel
Aceno inoxidable



D01120
12 cm - 4 3/4"



D01130
12 cm - 4 3/4"

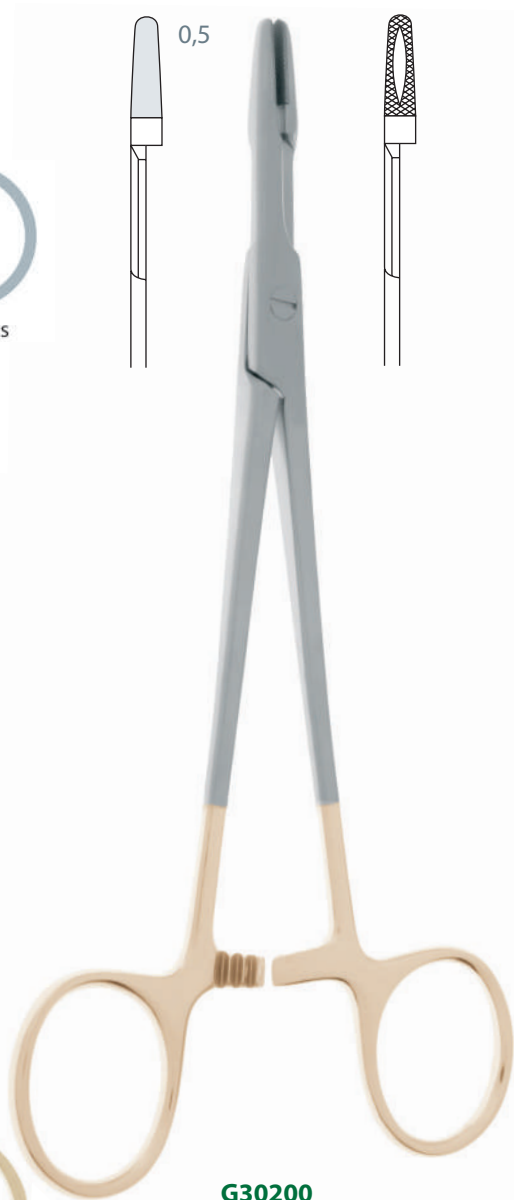

G30200
16 cm - 6 1/4"

VI - Sutures
VI - Sutures
VI - Sutura

GILLIES-BABY



GILLIES





TC Inserts

14 cm - 5 1/2"

G305000

14 cm - 5 1/2"

G305100

17 cm - 6 3/4"

G305010 

17 cm - 6 3/4"

G305110 

20 cm - 8"

G305015

20 cm - 8"

G305115

20 cm - 8"

G305215 

24 cm - 9 1/2"

G305020

24 cm - 9 1/2"

G305120

24 cm - 9 1/2"

G305220



G305010

17 cm - 6 3/4"



G305110

17 cm - 6 3/4"



G305215

20 cm - 8"

LICHTENBERG



TC Inserts

ZWEIFEL

20 cm - 8"

G305630

23 cm - 9"

G305640

LANGENBECK

16 cm - 6^{1/4}"

G305660

18 cm - 7"

G305670

20 cm - 8"

G305680



G305600
20 cm - 8"



G305630
20 cm - 8"



G305670
18 cm - 7"

REVERDIN



Inox
Stainless steel
Acero inoxidable



Droite
Straight
Recta

1/2 courbe
Half curved
Media curva

Courbe
Curved
Curva

Très courbe
Very curved
Muy curva

19 cm - 7 1/2"

G35004

G35008

G35012

G35016

21 cm - 8 1/4"



G35132

G35136

G35140

G35144

(paroi)

G35132

21 cm - 8 1/4"



DOYEN

En hameçon
Strongly curved
Forma de anzuelo



G40050
18 cm - 7"



G40060
17 cm - 6 ³/₄"



G40070
18,5 cm - 7 ¹/₄"



G40080
20 cm - 8"

EMMET



G40120
20 cm - 8"



G40110
19 cm - 7 1/2"

G40100
18 cm - 7"

PAUCHET (SABRE)



G40135
27 cm - 10 1/2"

STAMEY



G401360
25 cm - 9 3/4"



REDON

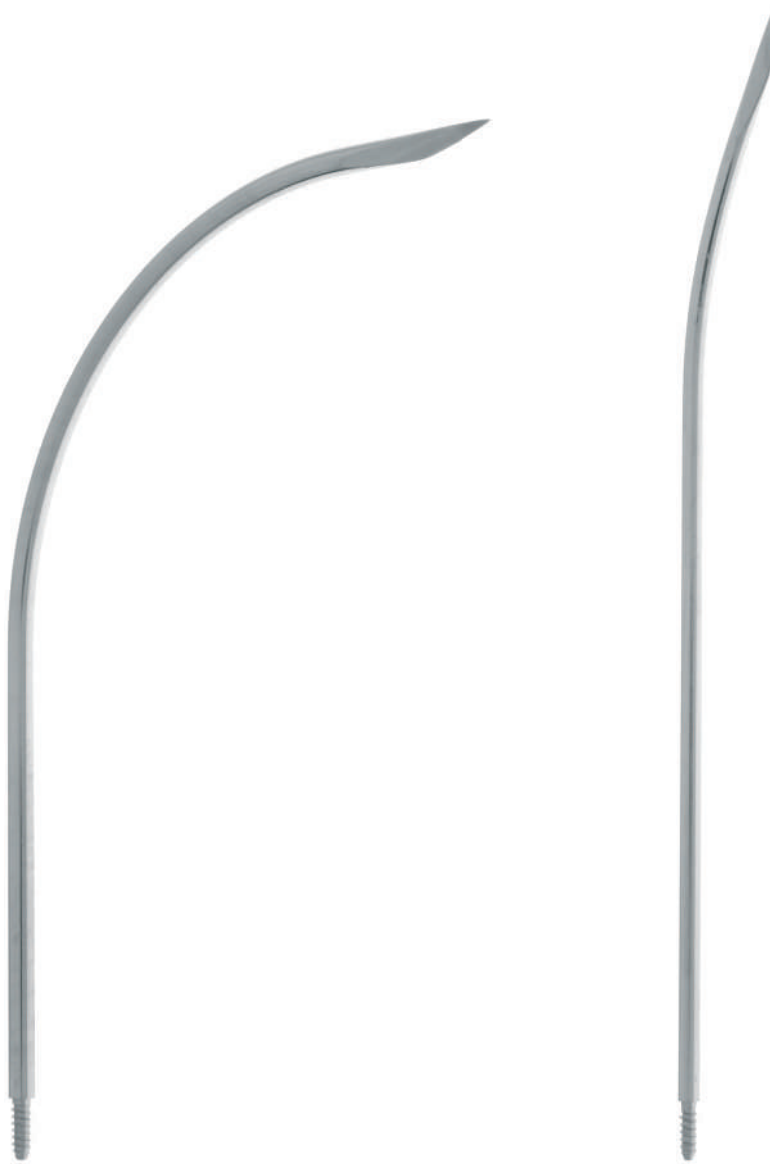

Courbe 20 cm
Curved 8"
Curva 20 cm



Droite 16 cm
Straight 6 1/4"
Recta 16 cm

G40270	2,3 mm / CH 07	G40210
G402350	2,5 mm / CH 08	G401750
G40240	3,0 mm / CH 09	G40180
G40275	3,3 mm / CH 10	G40215
G40250	4,0 mm / CH 12	G40190
G402550	4,6 mm / CH 14	G401950
G40260	5,0 mm / CH 15	G40200
G402650	5,3 mm / CH 16	G402050
G402670	6,0 mm / CH 18	G402070

DESCHAMPS SCHAUTA

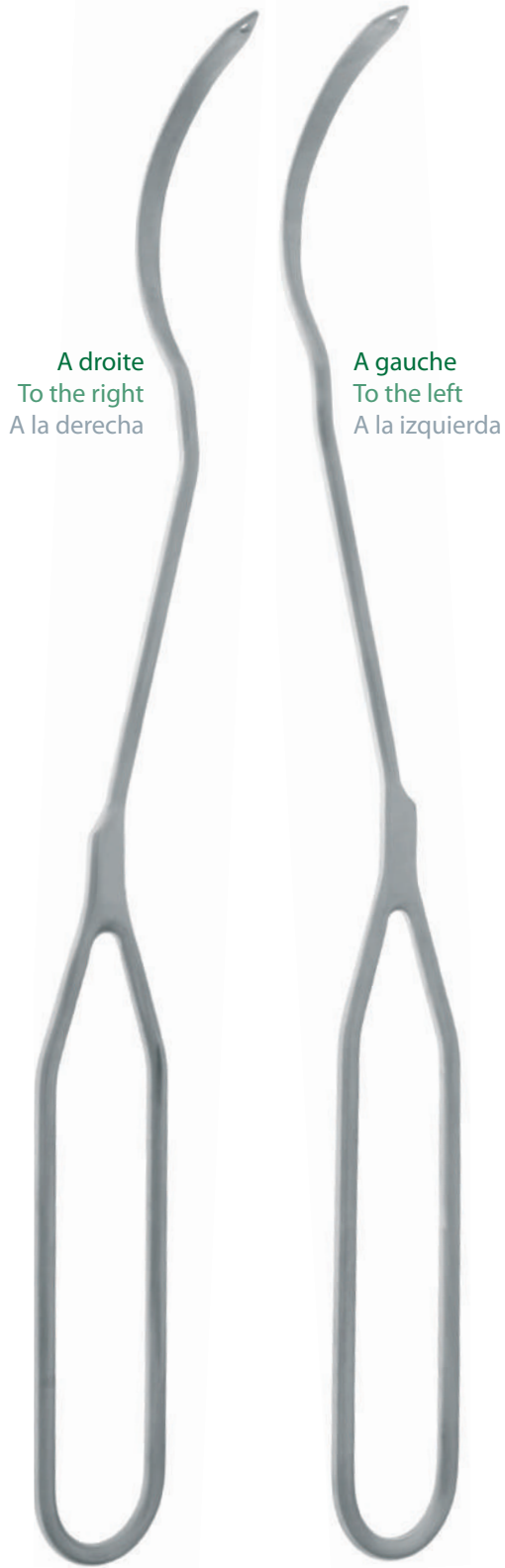

A droite
To the right
A la derecha

A gauche
To the left
A la izquierda

G403510
28 cm - 11"

G403520
28 cm - 11"

BRUNNER



G403540
30 cm - 12"

G403550
30 cm - 12"

VI - Sutures
VI - Sutures
VI - Sutura

DESCHAMPS

20 cm - 8"

G40350

20 cm - 8"

G40340

24 cm - 9 1/2"

G403501 

24 cm - 9 1/2"

G403401 

28 cm - 11"

G403502

28 cm - 11"

G403402



A gauche
To the left
A la izquierda

G403501
24 cm - 9 1/2"

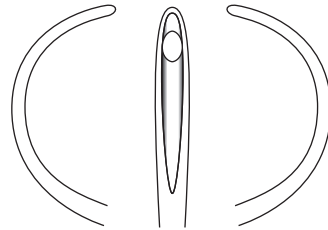

G40350 G40340

20 cm - 8"

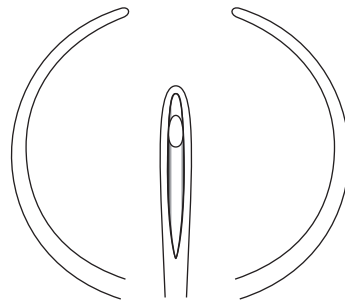

G403501 G403401

24 cm - 9 1/2"

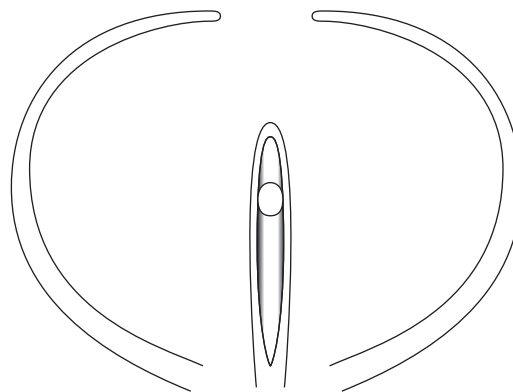

G403502 G403402

28 cm - 11"



A droite
To the right
A la derecha

G403401
24 cm - 9 1/2"

KÖNIG
(KOENIG)



G40360
19,5 cm - 7³/₄"



G403610
19,5 cm - 7³/₄"



G403620
20 cm - 8"

PAYR



G403630
22 cm - 8^{3/4}"

KIRSCHNER



G403640
25,5 cm - 10"

Pousse-noeuds
Knot pusher
Empujador de nodos



G403650
23 cm - 9"

Écarteurs, crochets - Retractors, hooks - Separadores, ganchos

GILLIES KLEINERT
KUTZ BARSKY HUMBY COTTLE KILNER BERGMANN LERICHE

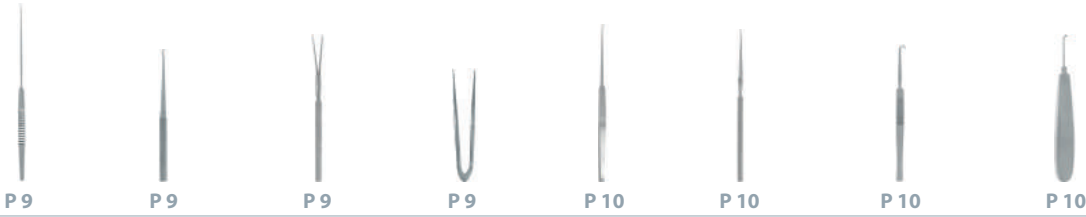

Écarteurs - Retractors - Separadores

Ajouré
Open work
Con ventana DESMARRES ABOULKER GIL-VERNET
PAPIN GIL-VERNET CUSHING KÖNIG LOVE
MORSE LOWE LUKENS



JACKSON ROSE MINI
LANGENBECK SEEN GREEN
CHIGOT LANGENBECK
GREEN CUSHING
KOCHER STRANDELL
STILLE MEYERDING SENN
MILLER



SEEN-MILLER
BABY RAGNEL
DAVIS KIENNY LANGENBECK
GREEN KLAPP VOLKMANN MURPHY

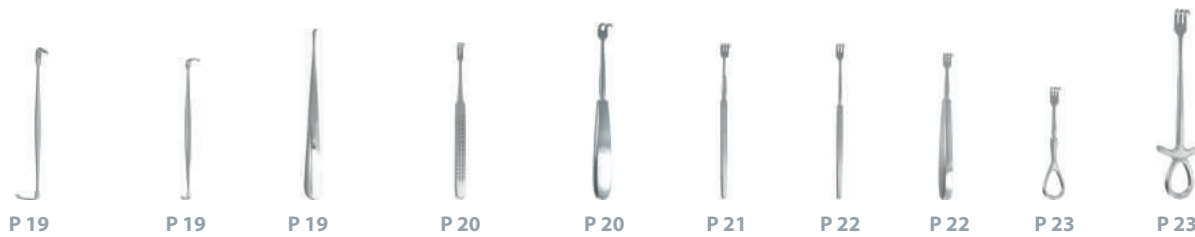

VOLKMANN KOCHER LAHEY KÖRTE KÖRTE
WAGNER ISRAEL KÖRTE OLLIER FARABEUF FARABEUF
CORTI



Écarteurs - Retractors - Separadores

CRILE LUER OPEN COELIO ROUX BABY ROUX COLLIN GOELET PARKER LANGENBECK US Army PARKER MATHIEU CANNY RYALL HARTMANN



PARKER MOTT CRAWFORD HIBBS HEANEY CHARRIER LARDENOIS TUFFIER HABERER LARDENOIS REVERDIN



ALLISON **Valve à poumon**
Blade for lung
Valva para pulmón CHEVRET KOCHER LANGENBECK FARABEU KOCHER LANGENBECK BRUNNER KOCHER WAGNER HÔSEL



CASPAR KOCHER ZENKER KÜMMEL KÔRTE KOCHER TUFFIER MEYERDING RICHARDSON EASTMAN RICHARDSON

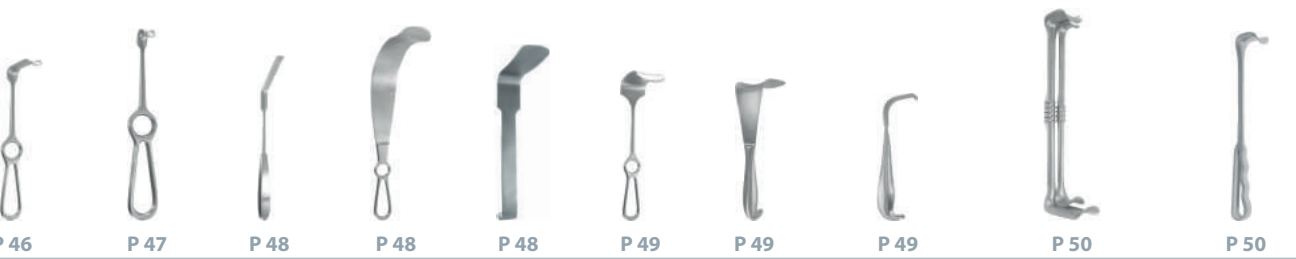

KELLY SIMON MARTIN SAUERBRUCH MORRIS SAUERBRUCH CORYLLOS MIKULICZ KELLY KADER SEGOND

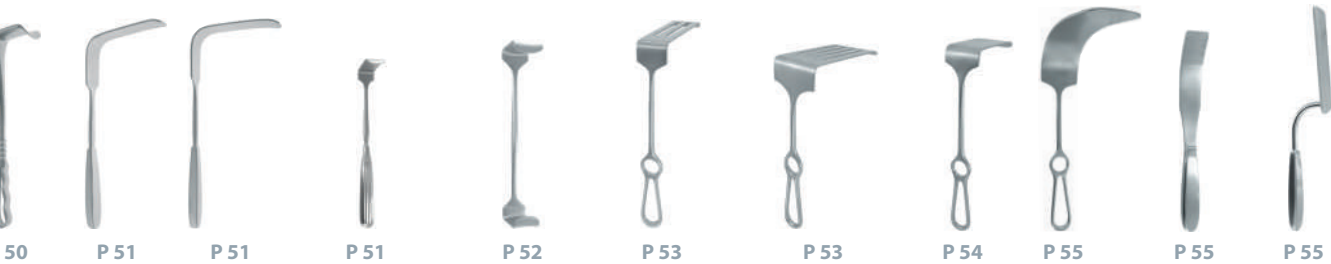

















































VII - 2

LANDANGER

Écarteurs - Retractors - Separadores

POLOSSON	LERICHE BUGATTI	HARRINGTON	HARRINGTON PEMBERTON	DEAVER	DEAVER	LEGUEU	Pour prostate For prostate Para prostate	FRITSCH			
P 56	P 57	P 58	P 58	P 59	P 60	P 60	P 60	P 61			
MIDDELDORF	DOYEN	MIDDELDORF	GREEN	CUSCHING	OBWEGESER	KIRSCH	DOCKHORN	SPINA NASALIS			
P 61	P 61	P 62	P 62	P 62	P 63	P 64	P 64	P 65			
RAMUS	OBWEGESER	DINGMAN	TESSIER	ROCHARD	ROCHARD	DOYEN ROCHARD	DESMARET	FOUCAULT	HAUTEFEUILLE		
P 65	P 65	P 66	P 66	P 67	P 68	P 69	P 70	P 71	P 72		
TOUPET	BERGERET TOUPET	RICARD	TOUPET	RICARD BEGOIN	RICARD	TOUPET	TOUPET ENTEROSTAT	COTT	PALMER	COLLIN	COLLIN
P 72	P 72	P 73	P 73	P 74	P 75	P 76	P 76	P 77	P 78	P 79	P 80
BABY COLLIN	MAYO ADAMS	OLIVIER	KIRSCHNER	DENIS BROWN	SEMM	O'SULIVAN O'CONNOR	AUVERT	GOSSET	MONTESTRUC	GOSSET	
P 81	P 81	P 82	P 83	P 84	P 85	P 85	P 86	P 87	P 87	P 88	

Écarteurs - Retractors - Separadores

BALFOUR	BALFOUR BABY	BALFOUR	BALFOUR USA MODEL	ABADIE	HRYNTSCHAK	MILLIN	JUDD MASSON	LEGUEU	DARTIGUES LAPAROSTAT
									
P 89	P 89	P 90	P 91	P 91	P 92	P 93	P 93	P 93	P 94
FINOCHIETTO	FINOCHIETTO	FINOCHIETTO	FINOCHIETTO	DUBOST	DUBOST NOGENT	REVERSIBLE	STERNAL ALUMINIUM	COOLEY	
									
P 95	P 96	P 97	P 98	P 99	P 100	P 101	P 101	P 102	
HAIGHT	DEBAKEY	STRUCK	MERCEDES	MORSE FAVALORO	RACHIS NOGENT	CHANDLER	DRYSSEN	FINOCHIETTO BURFORD	HERTZLER
									
P 102	P 103	P 104	P 105	P 105	P 106	P 106	P 107	P 107	P 108
TUFFIER	BAILEY	BAILEY	SELLORS	MAURER	MATHEY	TESSIER	FINSEN	ALM	HEISS HOLZEIMER
									
P 108	P 109	P 109	P 109	P 110	P 110	P 110	P 111	P 111	P 111
JANSEN DEEP	JANSEN	PLESTER	WEITLANER	WEITLANER	TRAVERS	HENLEY	MAC FEE	NORFOLK NORWICH	
									
P 112	P 112	P 113	P 114	P 115	P 115	P 116	P 117	P 117	

Écarteurs - Retractors - Separadores

WEITLANER	WEITLANER WULLSTEIN	WEITLANER NEURO	ANDERSON ADSON	BECKMANN CONE	BECKMANN	BECKMANN	BECKMANN			
										
P 118	P 118	P 119	P 119	P 120	P 120	P 121	P 122			
DECOULX	BECKMANN EATON	ADSON	HARVEY JACKSON	BECKMANN ADSON	ADSON	WALTON	MARKHAM MEYERDING	WILLIAMS		
										
P 123	P 124	P 124	P 124	P 125	P 126	P 127	P 128	P 129		
GELPI	DEBAKEY	JOLL	COURTY	BUCK GRAMCKO	LANGE HOHMANN	WAGNER	LANGE HOHMANN	LANGE HOHMANN	VERBRUGGE MULLER	
										
P 130	P 130	P 131	P 131	P 132	P 133	P 133	P 134	P 135	P 136	
LANGE HOHMANN	HOHMANN ALDINGER	SCHUMACHER WAGNER	SCHUMACHER	MERLE D'AUBIGNE	MERLE D'AUBIGNE	JUDET	CHANDLER	LANE	LANE	
										
P 137	P 137	P 138	P 138	P 139	P 140	P 140	P 141	P 141	P 141	
BRISTOW	BLOUNT	FUKUDA	BENNET	TRILLAT	CAUCHOIX	SKID MURPHY	LAMBOTTE	MOORE LAMBOTTE	POSTEL	MAURER
										
P 141	P 145	P 145	P 146	P 146	P 144	P 145	P 145	P 145	P 146	P 146

VIII - Voies basses
VIII - Gyne/Uro/Procto
VIII - Gyne/Uro/Procto

Valves vaginales - Vaginal blades - Valvas vaginales

DOYEN

MANGIAGALLI

DOUGLAS

DARGENT

LANDAU

BRIESKY



P 37

P 38

P 38

P 39

P 39

P 40

P 41

P 41

P 42

P 43

P 43

JACKSON

KRISTELLER

SIMS

DOYEN

MATHIEU

ST-MARKS

JAYLE

AUVARD

SCHERBAK

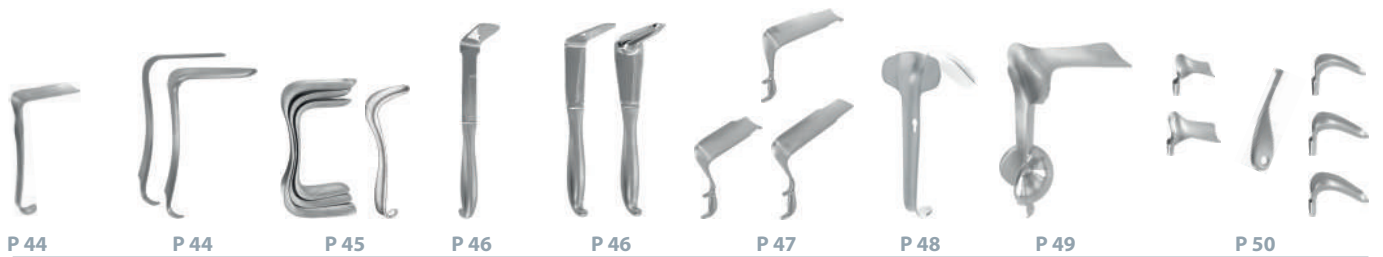

P 44

P 44

P 45

P 46

P 46

P 47

P 48

P 49

P 50

XI - Ortho-vertebre
XI - Ortho-vertebrae
XI - Ortho-vertebra

Neurochirurgie : spatules - Neurosurgery : spatulas - Neurocirugía : espátulas

CLOVIS VINCENT

OLIVECRONA

HEIFETZ

AACHEN



P 3



P 4



P 4



P 5



P 5

XI - Ortho-vertebre
XI - Ortho-vertebrae
XI - Ortho-vertebra

Neurochirurgie : écarteurs - Neurosurgery : retractors - Neurocirugía : separadores

LOVE

CASPAR

TAYLOR

HOLSHER

HESS



P 6



P 7



P 7

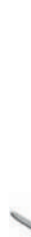

P 7



P 8



P 8

XII - O.R.L.
XII - E.N.T.
XII - O.R.L.

O.R.L. écarteurs - E.N.T. retractors - O.R.L. separadores

CLAOUE

AUBRY

DAUTREY

GINESTET AUFRICHT GUERRIER



P 48



P 48



P 48



P 48



P 48



P 48



P 49



P 49



P 49

Écarteur - Retractor - Separador

CHARNLEY

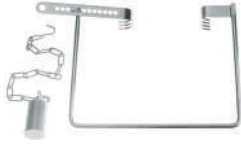

P 143

XIII - Osseux
XIII - Bone surgery
XIII - Cirugía osea

Instrumentation pour épaule - Shoulder instrumentation - Instrumentación para hombro

KÔLBEL



P 146

MERLE
D'AUBIGNE



P 147

Passe fil
Wire guide
Pasa hilo



P 147

POZZI



P 148

MERLE
D'AUBIGNE



P 148

BANKART



P 148

DANIS



P 149

Spatule
Spatula
Espátula



P 149

TRILLAT



P 149

XIII - Osseux
XIII - Bone surgery
XIII - Cirugía osea

Pour ménisque - For meniscus - Para menisco

SMILLIE
TRILLAT



P 151

NEFF



P 151

BIRCHER



P 151

SMILLIE
TRILLAT



P 152

BLOUNT



P 152

XIII - Osseux
XIII - Bone surgery
XIII - Cirugía osea

Mains de plomb - Lead hands - Manos de plomo



P 143

XIII - Osseux
XIII - Bone surgery
XIII - Cirugía osea

GILLIES



B80348 
n° 1 - 2,5 mm

B80349
n°2 - 3 mm

B80350
n°3 - 3,5 mm

B80351
n° 4 - 4 mm

B80353
double - 6 mm

B80348
18 cm - 7"

KLEINERT-KUTZ



B803533 
3 mm

B803535
5 mm

B803537
7 mm

B803533
13 cm - 5"

BARSKY



B803540
15 cm - 6"



B803541
15 cm - 6"

HUMBY



B803545
11,5 cm - 4 1/2"



COTTLE



B803550
16 cm - 6 1/4"

B803551
16 cm - 6 1/4"

KILNER



B803543
15,5 cm - 6"

BERGMANN



B803320
14 cm - 5 1/2"

LERICHE



B80337
15 cm - 6"



B80337
5 mm
15 cm - 6"



B80336
6 mm
20 cm - 8"



B80335
8 mm
27 cm - 10 1/2"

DESMARRES

ABOULKER

Ajouré
Open work
Con ventana



B803070
14 cm - 5 1/2"



B803070
12 mm



B803071
14 mm



B803072
16 mm



B803073
18 mm



B80301
15 cm - 6"



B80301
6 mm



B80302
8 mm



B80303
10 mm



B80304
12 mm



B80306
15 mm



B803062
16 mm



B803064
18 mm

Malléable
Malleable
Maleable



B80312
19 cm - 7 1/2"



10 mm



B80312
19 cm - 7 1/2"

B80316
25 cm - 10"



14 mm

B80314
19 cm - 7 1/2"

B80318
25 cm - 10"

GIL-VERNET (PAPIN)

	Rigide Rigid Rigida	Malleable Malleable Maleable
10 mm 	H20085	H20087
15 mm	H20089	H20091
20 mm	H20093	H20095

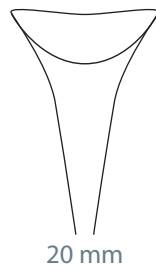

H20085
28 cm - 11"

GIL-VERNET

	Malleable Malleable Maleable
8 mm	H200961
11 mm	H200962
15 mm	H200963 
17 mm	H200964
20 mm	H200965
23 mm	H200966

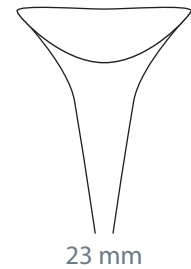
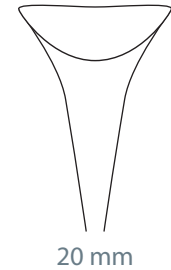
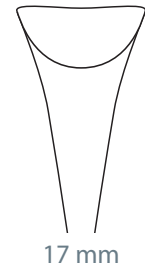



H200963
24 cm - 9 1/2"

CUSHING

KÖNIG

LOVE (MORSE)

Largeur Width Anchura	Longueur / Length / longitudud	
	20 cm - 8"	24 cm - 9 1/2"
8 mm	 B803080	B803090
10 mm	B803081	B803091
12 mm	B803082	B803092
14 mm	B803083	B803093
16 mm	B803084	B803094
18 mm	B803085	B803095

Largeur Width Anchura	
10 mm	B803074
15 mm	B803075
20 mm	B803076
30 mm	B803077 
40 mm	B803078
50 mm	B803079

Largeur Width Anchura	
13 mm	B803086
16 mm	B803087 

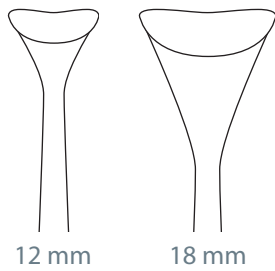
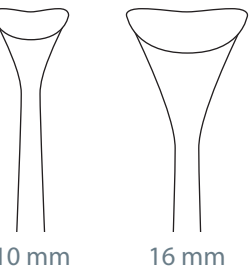
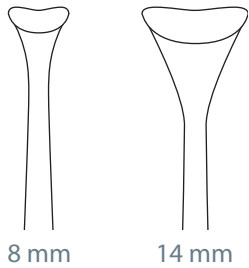

B803080
20 cm - 8"

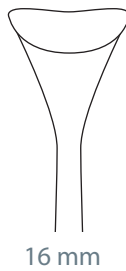
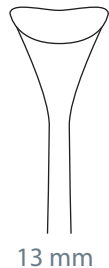

B803087
17 cm - 6 3/4"

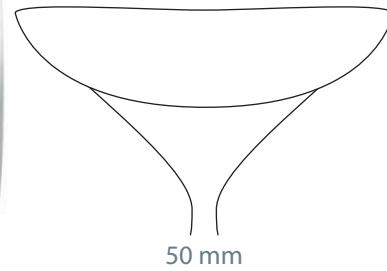
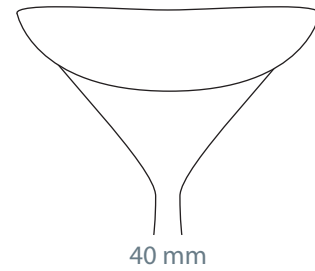
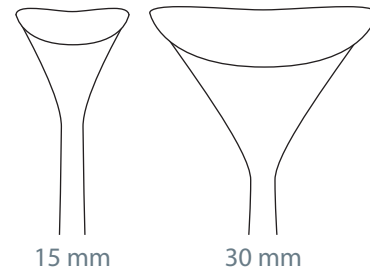
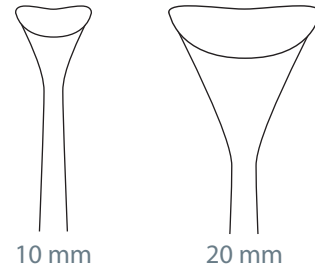
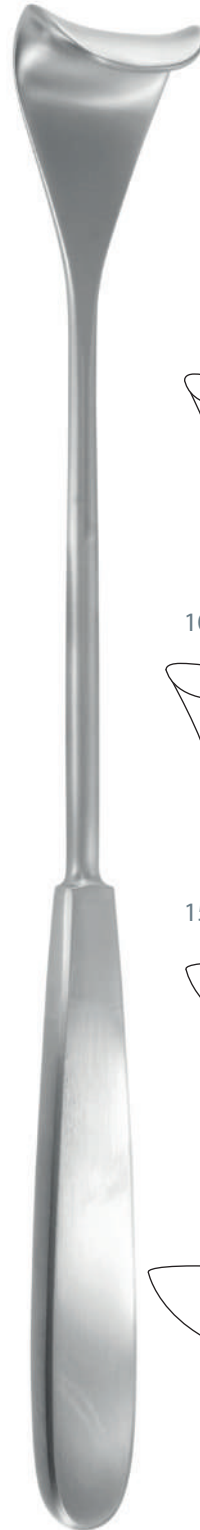

B803077
25 cm - 10"

LOWE



B80342

B80341

B80340

B80338
19 cm - 7 1/2"



LANDANGER

Écarteurs - Retractors - Separadores

LUKENS



B803282
17 cm - 6 ³/₄"

JACKSON



B803284
17 cm - 6 ³/₄"

ROSE

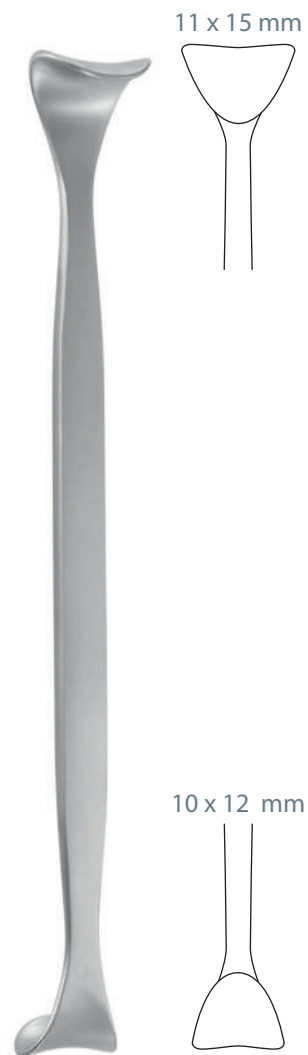

B803286
13 cm - 5"

MINI-LANGENBECK

SENN GREEN (CHIGOT)



B802862
6 x 10 mm

B802863 
5 x 17 mm



B802864
6 x 20 mm

B802865
8 x 22 mm

B802863
16 cm - 6 1/4"





B80081 
6 x 10 mm

B80083
6 x 20 mm

B80081
16 cm - 6 1/4"

LANGENBECK-GREEN



B803108 
6 x 25 mm

B803109
8 x 25 mm

B803108
17 cm - 6 ³/₄"

CUSCHING-KOCHER



10 mm

B803110
18 cm - 7"

STRANDELL-STILLE



B803112 
6 x 17 mm

B803113
6 x 17 mm

B803112
19 cm - 7 ¹/₂"

MEYERDING



B803101
18 cm - 7"

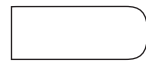

B803101 
7 x 18 mm



B803104
3 x 10 mm



B803103
4 x 7 mm



B803105
4 x 7 mm



B803102
5 x 16 mm

3 griffes pointues
3 sharp teeth
3 dientes agudas

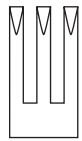

10 x 7 mm



B803106
18 cm - 7"

SENN-MILLER

SENN-MILLER BABY

RAGNEL (DAVIS)

KIENNY

Pointu
Sharp
Agudo

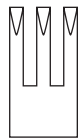

B80325
9 x 7 mm



Pointu
Sharp
Agudo

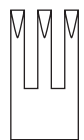

B803255
9 x 7 mm



Chausse veine
Vein holder
Porta veina



4 mm

Mousse
Blunt
Romo

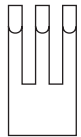

 **B80327**
9 x 7 mm



Mousse
Blunt
Romo

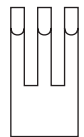

 **B803275**
9 x 7 mm



6 x 15 mm



6 x 15 mm

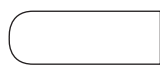

7 x 20 mm

B80327
16 cm - 6 1/4"



7 x 25 mm

B803275
16 cm - 6 1/4"



4 x 8 mm

B80328
14 cm - 5 1/2"



B80330
17 cm - 6 3/4"



LANGENBECK-GREEN

KLAPP



B803302
16 cm - 6 1/4"



B803301
7 mm



B803305
13 x 11 mm



 **B803302**
5 x 5 mm



B803306
6 x 16 mm



B803303
5 x 12 mm



B803307
6 x 25 mm



B803310
17,5 cm - 7"



B803310 
12 x 6 mm



B803311
12 x 11 mm



B803312
15 x 11 mm

Flexible
Flexible
Flexible



B812105
16 cm - 6 1/4"

Pointu
Sharp
Agudo

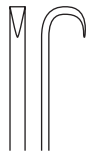

B812101
4 mm



B812103
5 x 5 mm

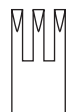

B812105
5 x 7 mm

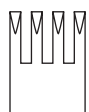

B812107
5 x 10 mm

Mousse
Blunt
Romo

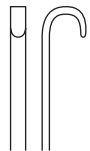

B812102
4 mm



B812104
5 x 5 mm

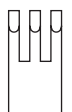

B812106
5 x 7 mm

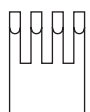

B812108
5 x 10 mm



B812101
16 cm - 6 1/4"

Pointu
Sharp
Agudo



B812025
5 x 10 mm

Mousse
Blunt
Romo

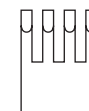

B812026
5 x 10 mm



B812025
16 cm - 6 1/4"

VOLKMANN



Pointu
Sharp
Agudo

B812011 7 mm



B812013 7 x 6 mm



 **B812015** 7 x 9 mm

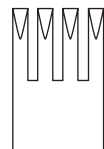

B812017 7 x 12 mm

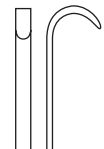

Mousse
Blunt
Romo

B812012 7 mm



B812014 7 x 6 mm

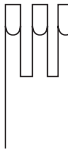

B812016 7 x 9 mm

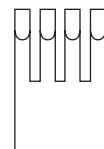

B812018 7 x 12 mm

B812015
16 cm - 6 1/4"

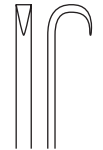

Pointu
Sharp
Agudo

B812001 5 mm



B812003 5 x 5 mm



 **B812005** 5 x 8 mm

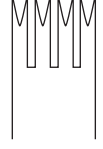

B812007 5 x 11 mm

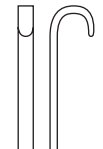

Mousse
Blunt
Romo

B812002 5 mm



B812004 5 x 5 mm

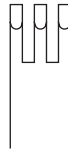

B812006 5 x 8 mm

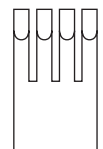

B812008 5 x 11 mm

B812005
16 cm - 6 1/4"

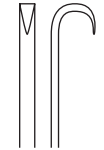

Pointu
Sharp
Agudo

B80218 6 mm

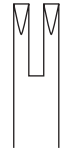

B80220 6 x 6 mm



B80240 6 x 9 mm



B80266 6 x 12 mm

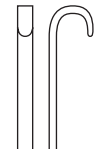

Mousse
Blunt
Romo

B80219 6 mm



B80225 6 x 6 mm

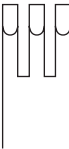

 **B80245** 6 x 9 mm



B80267 6 x 12 mm

B80245
15 cm - 6"

VOLKMANN

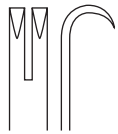

B812203

Pointu
Sharp
Agudo

7 x 5 mm

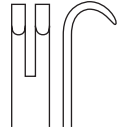

B812204

Mousse
Blunt
Romo

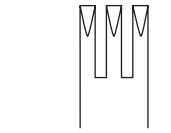

B812205

7 x 9 mm

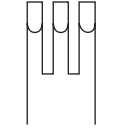

B812206

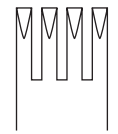

B812207

7 x 12 mm

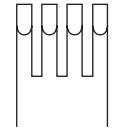

B812208

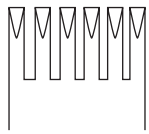

B812209

7 x 18 mm

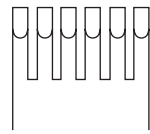

B812210



B812205

11,5 cm - 4 1/2"

MURPHY

Pointu
Sharp
Agudo

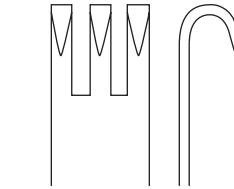

B812305

8 x 13 mm

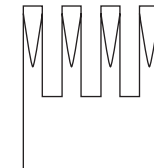

B812307

8 x 18 mm

Mousse
Blunt
Romo

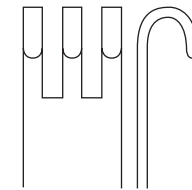

B812306

8 x 13 mm

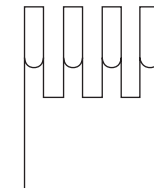

B812308

8 x 18 mm

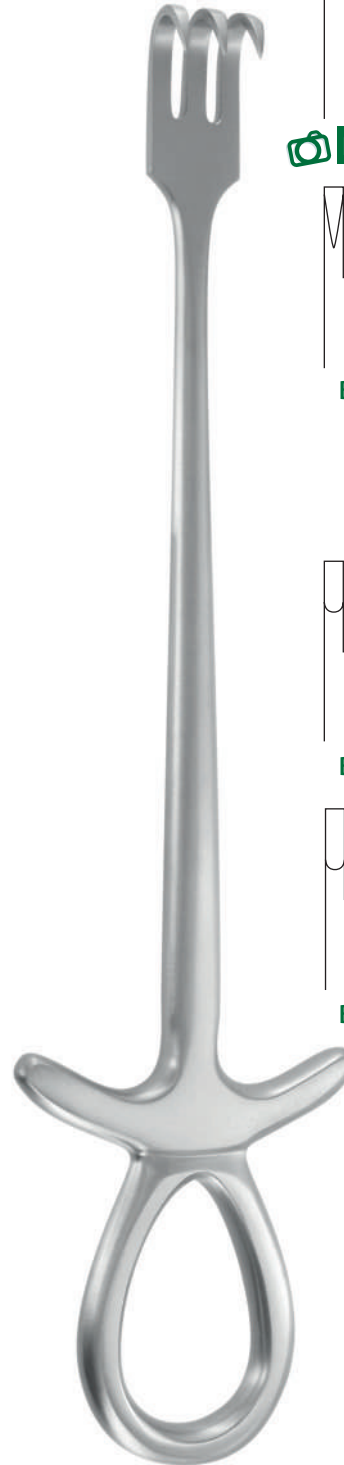

B812305

19,5 cm - 7 3/4"



VOLKMANN



B80150
22 cm - 8 5/8"

Pointu
Sharp
Agudo

Semi-Pointu
Semi-Sharp
Semi-Agudo

Mousse
Blunt
Romo

19 mm

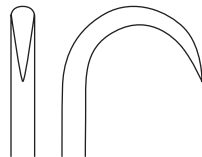

B801492

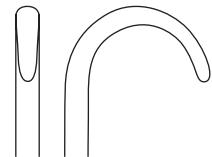

B801493

9 x 8 mm

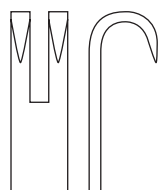

 **B80150**

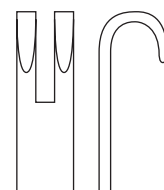

B801570

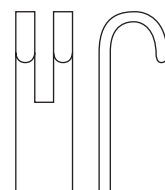

B80155

9 x 13 mm



B80160

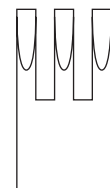

B801670

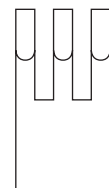

B80165

9 x 19 mm

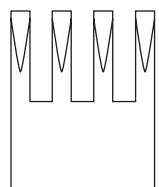

B80170

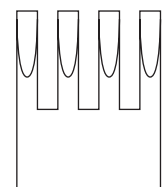

B801770

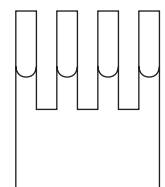

B80175

9 x 28 mm

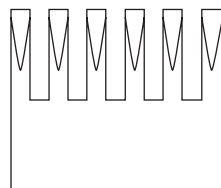

B80190

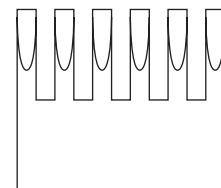

B801970

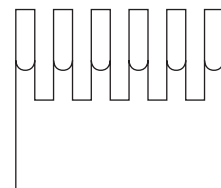

B80195

9 x 36 mm

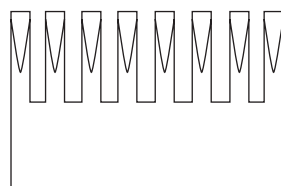

B80210

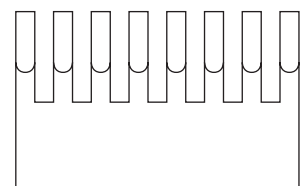

B80215

VOLKMANN



B80151

22 cm - 8 5/8"

Pointu
Sharp
Agudo

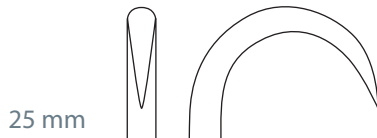

25 mm

B801490

Semi-Pointu
Semi-Sharp
Semi-Agudo

Mousse
Blunt
Romo



9 x 8 mm

B80151

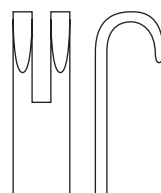

B801575

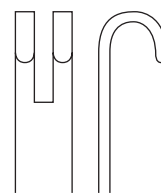

B80156

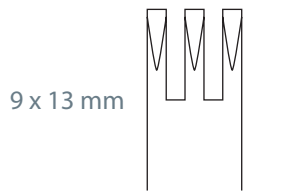

9 x 13 mm

B80161

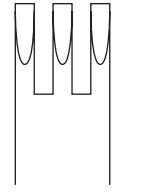

B801675

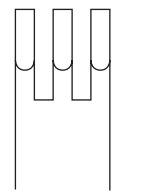

B80166



9 x 19 mm

B80171

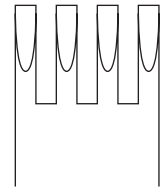

B801775

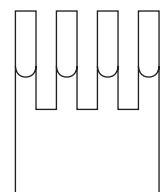

B80176

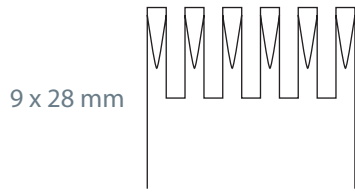

9 x 28 mm

B80191

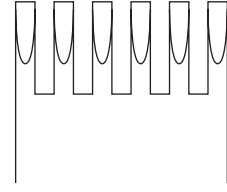

B801975

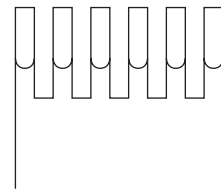

B80196

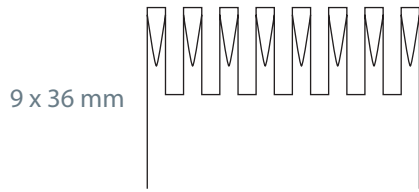

9 x 36 mm

B80211

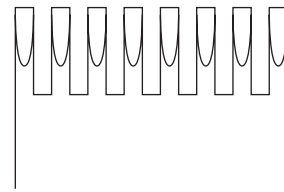

B802175

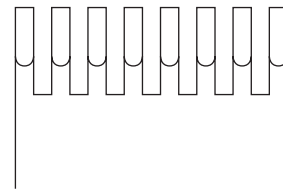

B80216



KOCHER



B802869
22 cm - 8^{3/4}"

Pointu
Sharp
Agudo

Semi-Pointu
Semi-Sharp
Semi-Agudo

Mousse
Blunt
Romo

15 mm

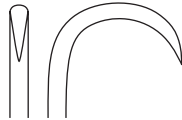

B802866



B802852

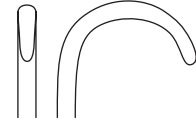

B802872

15 x 8 mm



B802867

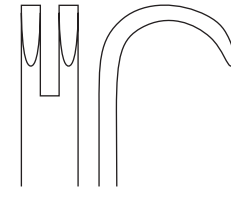

B802853

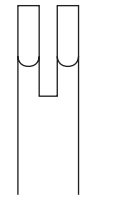

B802873

15 x 13 mm

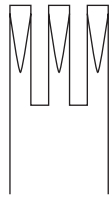

B802868

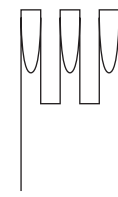

B802854

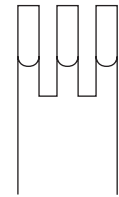

B802874

15 x 18 mm

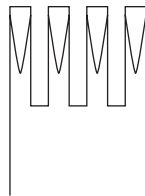

 **B802869**

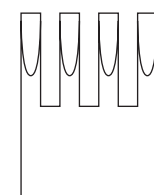

B802855

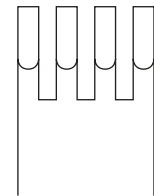

B802875

15 x 27 mm

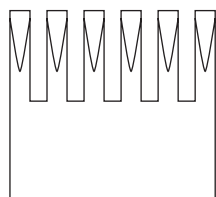

B802870

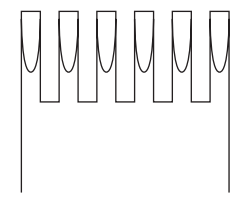

B802856

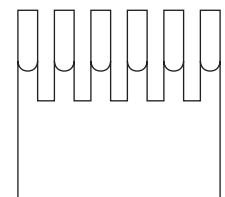

B802876

15 x 36 mm

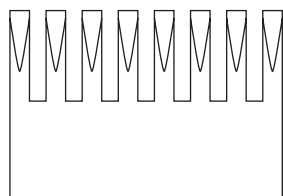

B802871

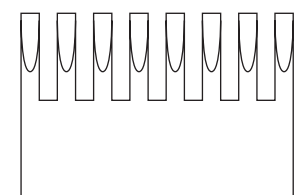

B802857

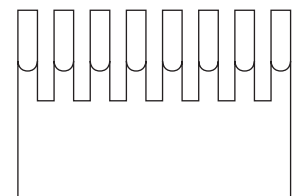

B802877

KOCHER

LAHEY

Modèle fort
Strong model
Modelo fuerte



B802880
22 cm - 8 3/4"



28 mm
Pointu
Sharp
Agudo

B802880 

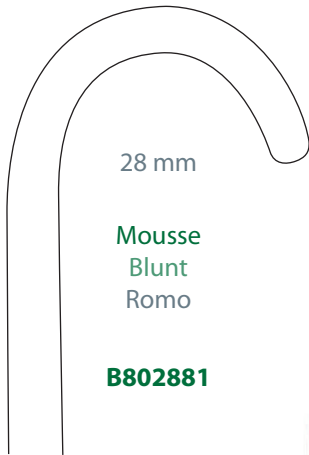

28 mm
Mousse
Blunt
Romo

B802881



B802878
24,5 cm - 9 3/4"



23 mm
Pointu
Sharp
Agudo

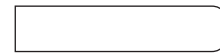

6 x 28 mm



B802883
19 cm - 7 1/2"

KÖRTE

KÖRTE-WAGNER



ISRAEL



B80268

45 x 40 mm

B80269

45 x 50 mm

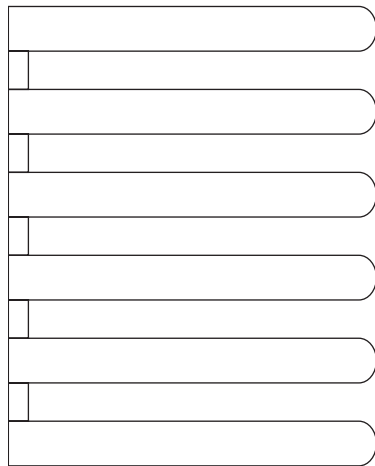

B80270

50 x 60 mm

B80271

70 x 70 mm

B80268
23 cm - 9"

KÖRTE

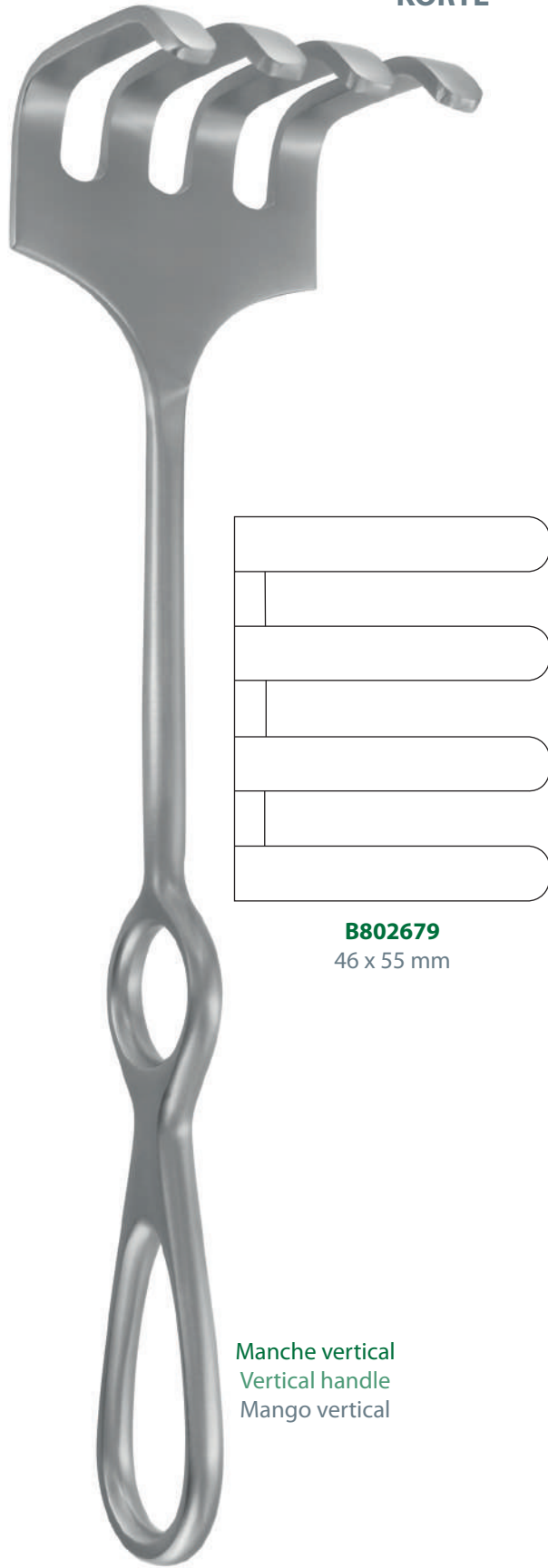

B802679

46 x 55 mm

Manche vertical
Vertical handle
Mango vertical

B802679
23 cm - 9"

OLLIER



B80360
22 cm - 8 3/4"

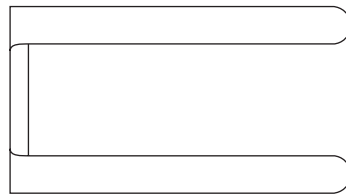

B80360
25 x 45 mm

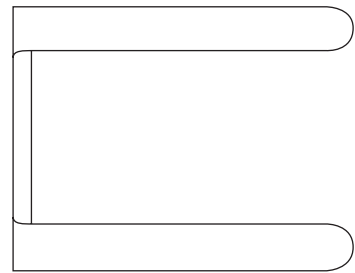

B80365
35 x 45 mm

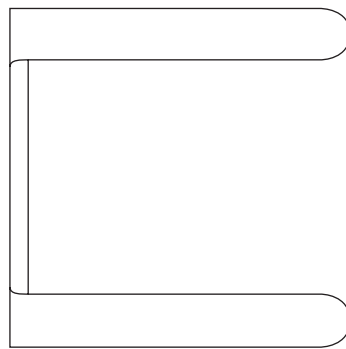

B80370
45 x 45 mm

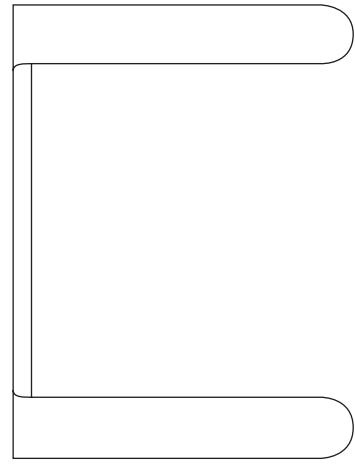

B80375
60 x 45 mm

FARABEUF

Jeu de 2 - Set of 2 - Juego de 2

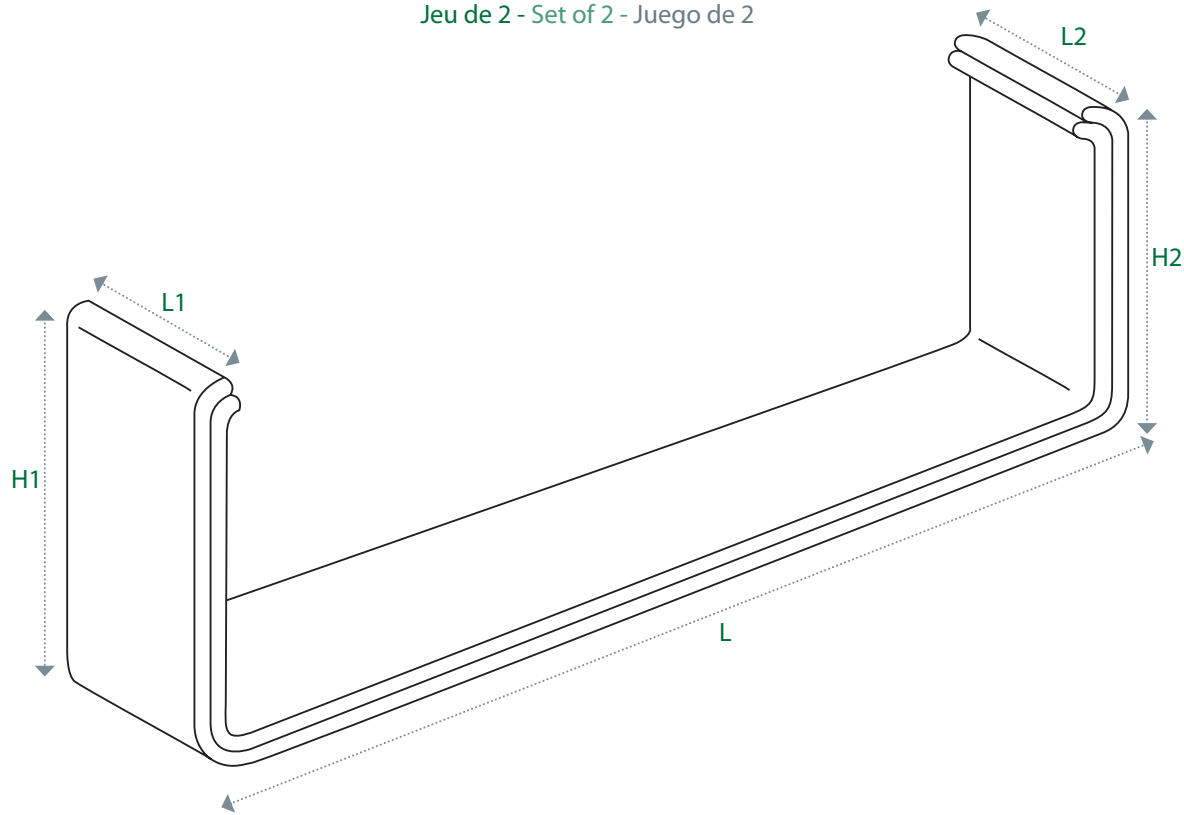

	L1 x H1 (mm)	L (mm)	L2 x H2 (mm)
B80117	8 x 18	100	10 x 20
B80120	7 x 20	120	9 x 25
B80125	10 x 20		14 x 25
B801255	15 x 30	130	15 x 40
 B80130	13 x 25	150	16 x 35
B80135	15 x 25		21 x 35
B801351	15 x 30		15 x 40
B801352	15 x 30		15 x 50
B801353	15 x 30		15 x 60
B801354	15 x 40		15 x 60
B801356	20 x 40		175
B801358		200	20 x 60
B801359			20 x 50



B80130
15 cm - 6"

FARABEU

Fabrication spéciale - Écarteur de FARABEU (paire)
Special manufacture - FARABEU retractor (pair)
Fabricación especial - Separador de FARABEU (par)

Établissement :
Establishment
Establecimiento

Rédigé par :
Written by
Escrito por

Date :
Date
Fecha

Visa :
Visa
Visa

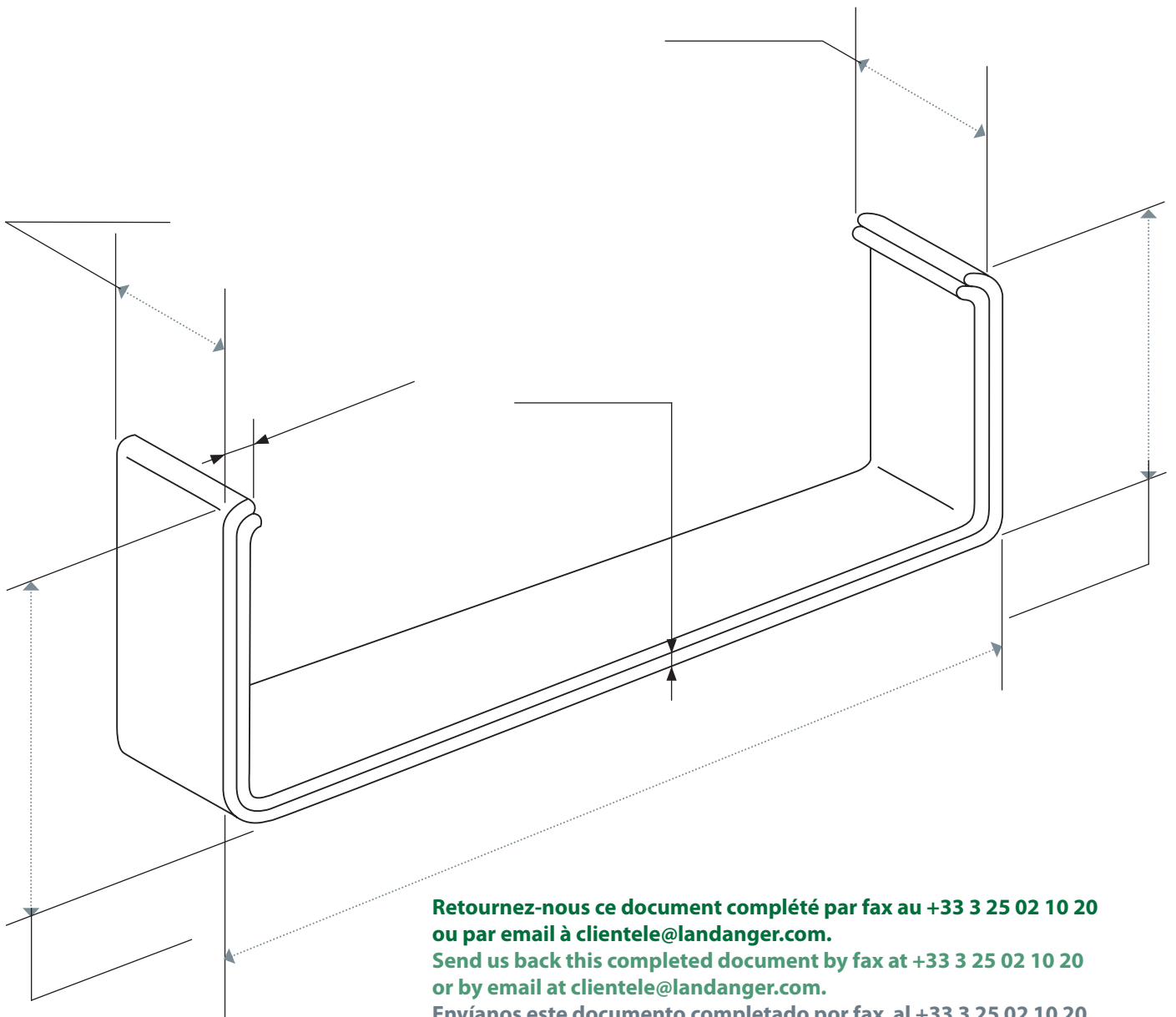

**Retournez-nous ce document complété par fax au +33 3 25 02 10 20
 ou par email à clientele@landanger.com.**

**Send us back this completed document by fax at +33 3 25 02 10 20
 or by email at clientele@landanger.com.**

**Envíanos este documento completado por fax al +33 3 25 02 10 20
 o por correo a clientele@landanger.com**

FARABEU-FORTI

Jeu de 2
Set of 2
Juego de 2

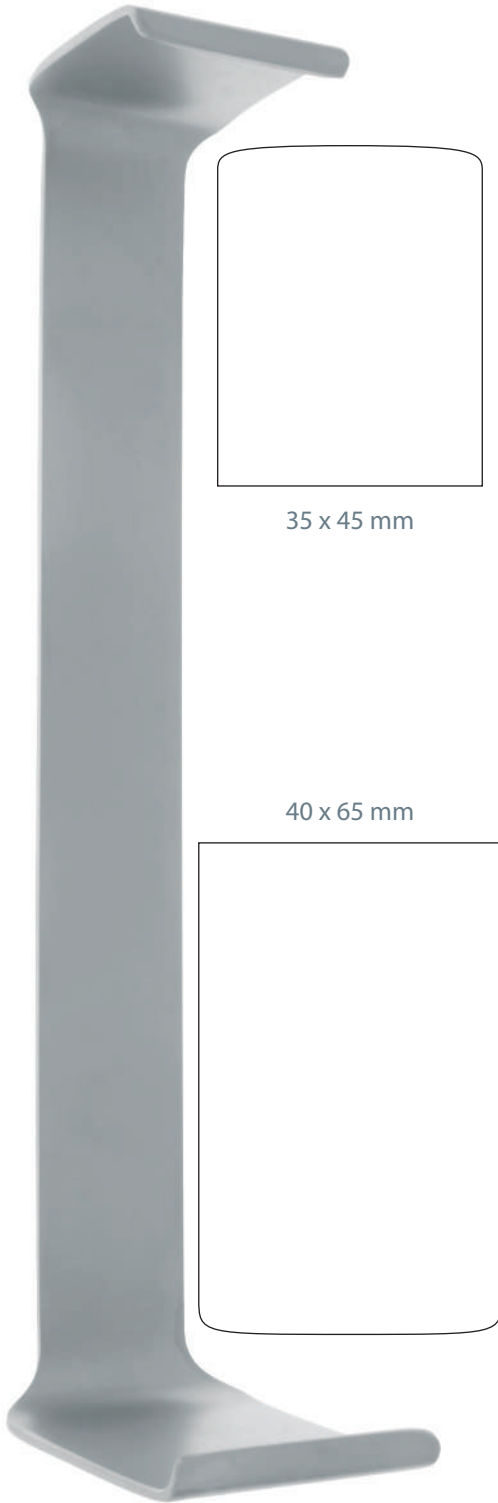

B80136
20 cm - 8"

CRILE

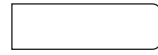

6 x 20 mm

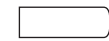

4 x 12 mm

B801363
11 cm - 4 1/4"

LUER

7 x 15 mm



7 x 11 mm

B80137
11 cm - 4 1/4"

OPEN COELIO

12 mm



12 mm

B801422
20 cm - 8"



ROUX

BABY-ROUX

COLLIN

GOELET

À l'unité
Per unit
La unidad

15 cm - 6"

B801451 n°1



16 cm - 6 1/3"

B801452 n°2

17 cm - 6 3/4"

B801453 n°3

Jeu de 3
Set of 3
Juego de 3

17 x 15 mm

Jeu de 2
Set of 2
Juego de 2
15 x 33 mm

37 x 40 mm



B80145
170 mm - 6 3/4"



20 x 22 mm
B801455
13,5 cm - 5 1/4"



17 x 37 mm
B801456
16,5 cm - 6 1/2"



30 x 31 mm
B801457
19 cm - 7 1/2"

PARKER LANGENBECK (US ARMY)

Jeu de 2
Set of 2
Juego de 2

30 x 16 mm



45 x 16 mm
B801480
21 cm - 8 1/4"



PARKER

Jeu de 2
Set of 2
Juego de 2

27 x 15 mm



27 x 15 mm
B801458
13,5 cm - 5 1/2"

27 x 25 mm



27 x 25 mm
B801459
18 cm - 7"

MATHIEU

50 x 13 mm

Jeu de 2
Set of 2
Juego de 2



50 x 26 mm
B801460
20 cm - 8"



CANNY-RYALL

B801483

16 mm
19 cm - 7 1/2"

 **B801484**

20 mm
19 cm - 7 1/2"

B801485

25 mm
20 cm - 8"



B801484
19 cm - 7 1/2"

HARTMANN

Jeu de 2
Set of 2
Juego de 2

37 x 32 mm



48 x 35 mm
B80140
16 cm - 6 1/4"

PARKER-MOTT

Jeu de 2
Set of 2
Juego de 2

65 x 24 mm



30 x 24 mm
B801486
14,5 cm - 5 3/4"

CRAWFORD

B801488 

15 x 23 mm

B801487

15 x 15 mm

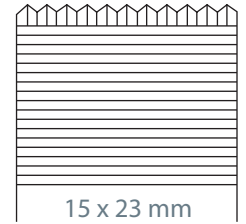

15 x 23 mm
B801488
19 cm - 7 1/2"

HIBBS



B801364 

75 x 25 mm

B801365

80 x 25 mm

B801364

24 cm - 9 1/2"

HEANEY



B801366

45 x 25 mm

B801367 

73 x 28 mm

B801368

82 x 28 mm

B801367

27 cm - 10 3/4"

CHARRIER

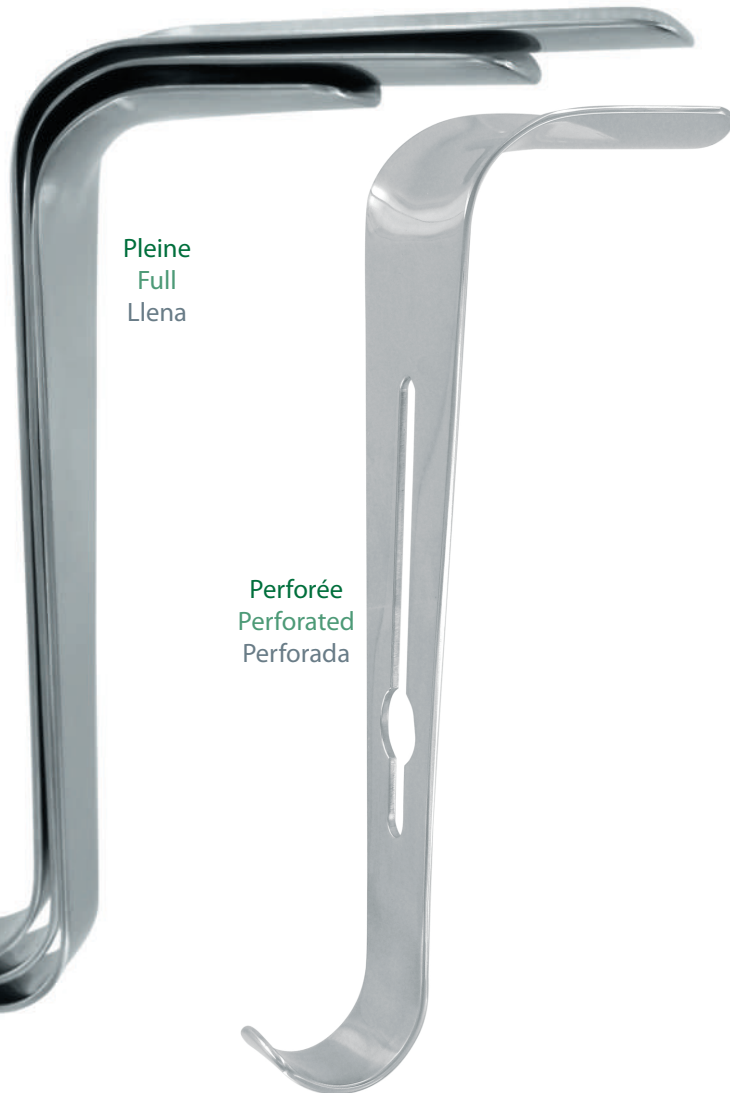

Pleine
Full
Llena

Perforée
Perforated
Perforada

B801375

20 cm - 8"

B801376

20 cm - 8"

Jeu de 3
Set of 3
Juego de 3

40 x 60 - 90 - 120 mm

LARDENOIS

- 27 cm - 10 1/2" **B80380** 25 x 40 mm
- 27 cm - 10 1/2" **B80382** 25 x 65 mm
- 36 cm - 10 1/2" **B80385** 25 x 40 mm

25 mm



Malléable
Malleable
Maleable

65 mm
B80382
27 cm - 10 1/2"

TUFFIER

17 mm



Malléable
Malleable
Maleable

25 mm
B803790
20 cm - 8"

HABERER

- 28 cm - 11" **B803830** 25 x 30 mm
- 30 cm - 11 3/4" **B803831** 37 x 45 mm
- 30 cm - 11 3/4" **B803832** 40 x 50 mm

45 mm



Malléable
Malleable
Maleable

Malléable
Malleable
Maleable

37 mm
B803831
30 cm - 11 3/4"

50 mm



50 x 150 mm
B803890
40 cm - 15 3/4"

LARDENOIS

30 mm



Malléable
Malleable
Maleable

20 cm - 8"

- 6 mm **B803910**
- 8 mm **B803911**
- 10 mm **B803912**
- 12 mm **B803913**
- 17 mm **B803914**
- 20 mm **B80386**
- 25 mm **B803915**

25 cm - 10"

- 25 mm **B803920**
- 30 mm **B80388**

33 cm - 13"

- 20 mm **B803930**
- 25 mm **B803931**
- 30 mm **B803932** 
- 35 mm **B803933**
- 40 mm **B803934**
- 45 mm **B803935**
- 50 mm **B803936**
- 64 mm **B803937**
- 76 mm **B803938**
- 102 mm **B803939**

B803932
33 cm - 13"

30 mm



Malléable
Malleable
Maleable

B80390
36 cm - 14 1/4"

REVERDIN (PAUCHET)

65 mm



B803905
28 cm - 11"

ALLISON

25,5 cm - 10"

B804105

30 cm - 12"

B804110



B804110
30 cm - 12"

B804120
30 cm - 12"

VALVE À POUMON BLADE FOR LUNG VALVA PARA PULMÓN

135 mm

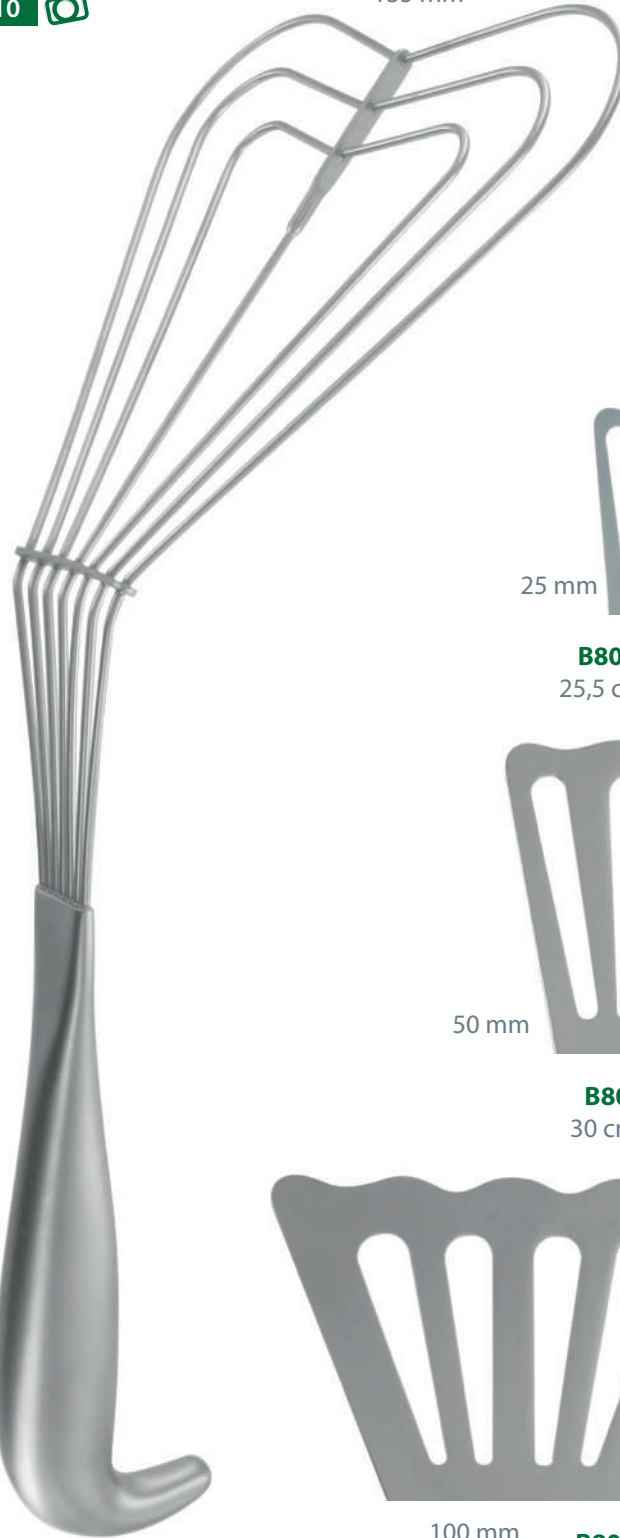

100 mm **B80410**
30 cm - 12"

25 mm **B803990**
25,5 cm - 10"

50 mm **B80400**
30 cm - 12"

CHEVRET

Malléable
Malleable
Maleable

80 mm



B80405
30 cm - 12"

SILICONE SURMOULÉE
SILICON COATED
SILICONE MOLDEADAS

Patented
Modèle déposé
Patentado

Valves souples
Flexible blades
Válvulas ligeras

Avec 2 points d'accrochage - With 2 anchors - Con 2 puntos de enganche

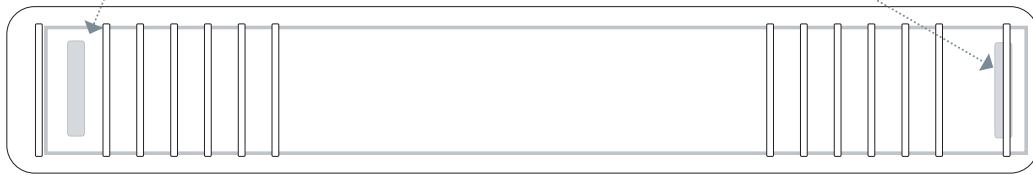

B803940 

50 mm
30 cm - 11 ³/₄"

Avec 4 points d'accrochage - With 4 anchors - Con 4 puntos de enganche

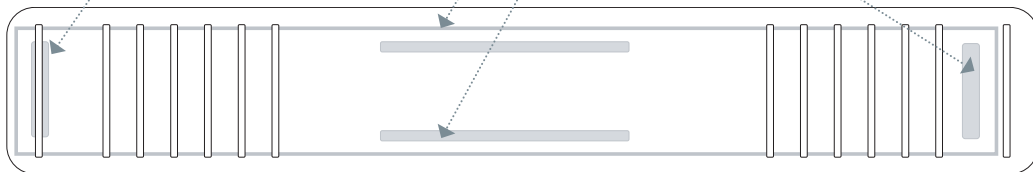

B803941

50 mm
30 cm - 11 ³/₄"

Valve ferme
Firm blade
Válvula rígida

Sans point d'accrochage - Without any anchor - Sin puntos de enganche



B803942

50 mm
30 cm - 11 ³/₄"



KOCHER-LANGENBECK

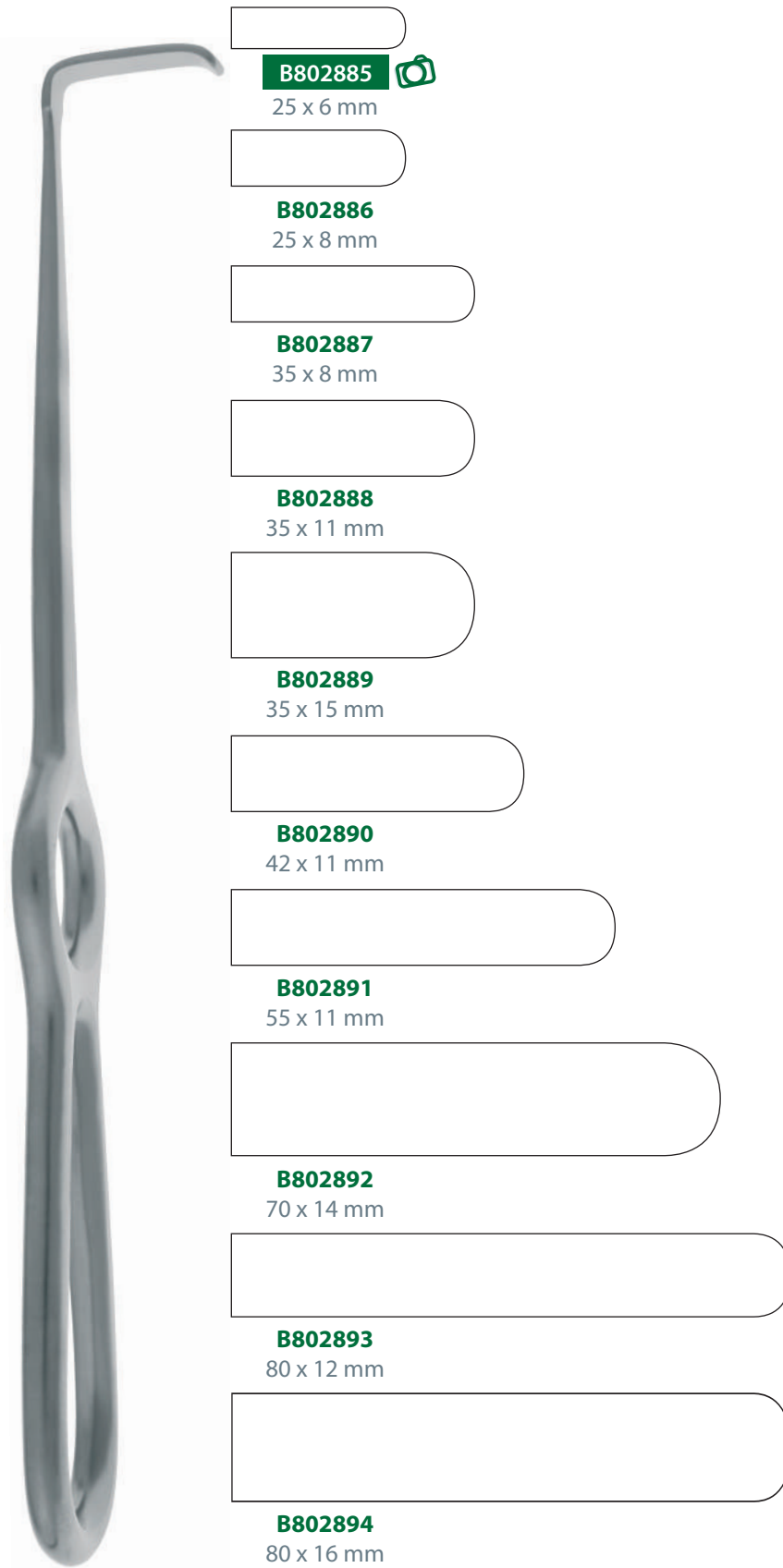

B802885
21,5 cm - 8 1/2"

FARABEUF



B80085
22 cm - 8 3/4"

KOCHER



B80275 
40 x 18 mm



B80275
60 x 20 mm



B80276
60 x 25 mm

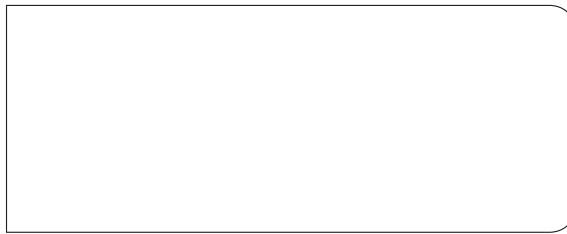

B80276
75 x 30 mm

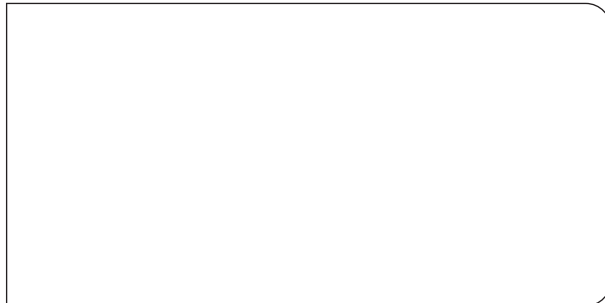

B80277
80 x 40 mm



B80275
22 cm - 8 3/4"

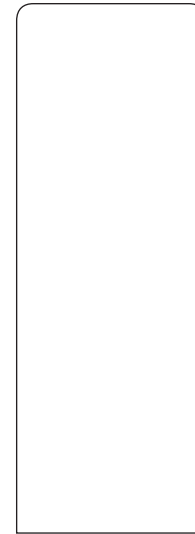

B80277
70 x 25 mm

B80277
22,5 cm - 8 4/5"

LANGENBECK



85 x 15 mm



Manche vertical
Vertical handle
Mango vertical

B802860
21,5 cm - 8 1/2"

B80285
21 cm - 8 1/4"



B80278
30 x 10 mm

B802785 
30 x 10 mm



B80279
30 x 14 mm

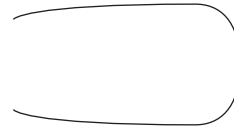

B80280
30 x 16 mm



B80281
40 x 10 mm

B802815
40 x 10 mm



B80282
43 x 13 mm

B802825
43 x 13 mm



B802826
50 x 11 mm



B80283
55 x 20 mm

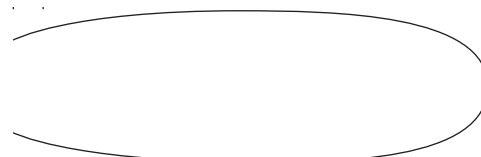

B80285 
63 x 20 mm



B802785
22 cm - 8 3/4"

BRUNNER

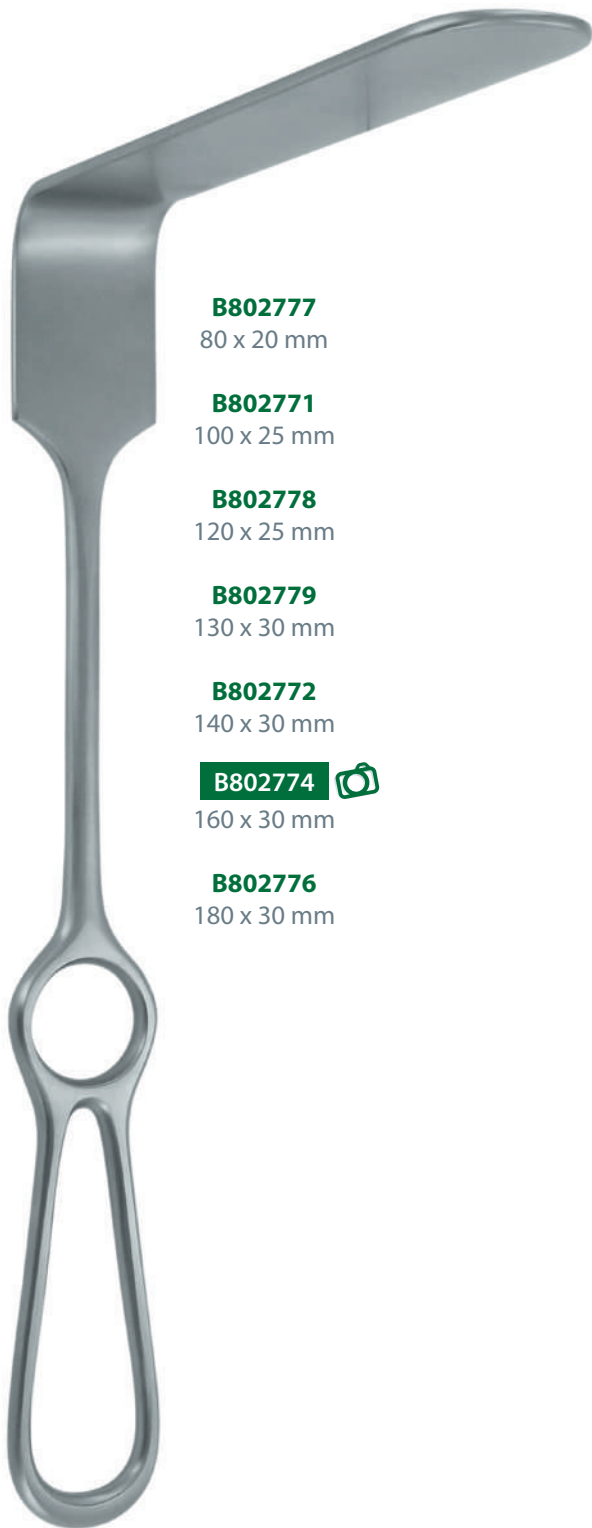

B802777

80 x 20 mm

B802771

100 x 25 mm

B802778

120 x 25 mm

B802779

130 x 30 mm

B802772

140 x 30 mm

B802774 

160 x 30 mm

B802776

180 x 30 mm

B802774
25 cm - 10"



B812770

80 x 20 mm

B812771

100 x 20 mm

B812772 

120 x 25 mm

B812773

140 x 25 mm

B812774

160 x 30 mm

B812775

180 x 30 mm

B812772
25 cm - 10"

KOCHER - WAGNER

HÖSEL

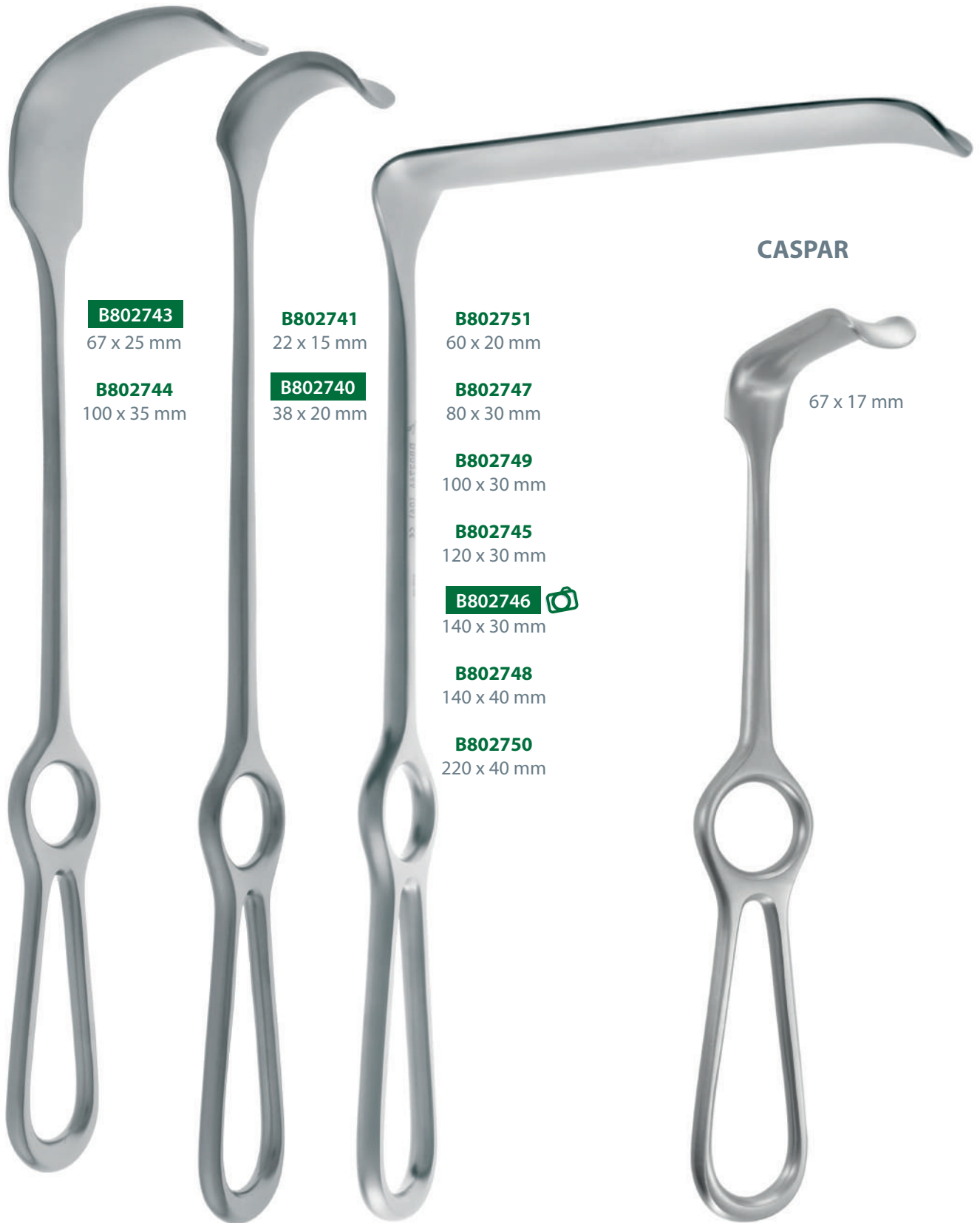

B802743
67 x 25 mm

B802744
100 x 35 mm

B802741
22 x 15 mm

B802740
38 x 20 mm

B802751
60 x 20 mm

B802747
80 x 30 mm

B802749
100 x 30 mm

B802745
120 x 30 mm

B802746 
140 x 30 mm

B802748
140 x 40 mm

B802750
220 x 40 mm

CASPAR

67 x 17 mm

B802743
28 cm - 11"

B802740
28 cm - 11"

B802746
25 cm - 10"

B812800
21,5 cm - 8 1/2"

KOCHER



B802861
21 cm - 8 1/4"



B812810
19 cm - 7 1/2"



B812820
22 cm - 8 3/4"



ZENKER

KÜMMEL

KÖRTE



B812830
35 x 8 mm
25 cm - 10"

B812831
60 x 12 mm
26 cm - 10 1/4"

B812832 
75 x 12 mm
27,5 cm - 10 3/4"

B812833
120 x 12 mm
29 cm - 12 1/2"

B812832
27,5 cm - 10 3/4"



46 mm

B812840
33 cm - 13"



120 x 46 mm

Rigide
Rigid
Rigido

B812845
28 cm - 11"

KOCHER

80 x 45 mm



B812850 

80 x 45 mm

B812851

80 x 55 mm

B812852

80 x 65 mm

B812850
25 cm - 10"

TUFFIER

64 x 60 mm



B812860
23 cm - 9"

MEYERDING

52 x 16 mm



B812870 

52 x 16 mm
21 cm - 8¹/₄"

B812871

75 x 25 mm
23 cm - 9"

B812872

90 x 50 mm
25 cm - 10"

B812870
21 cm - 8¹/₄"

RICHARDSON-EASTMAN



B801478
28 cm - 11"

RICHARDSON



B801464
24 cm - 9 1/2"

KELLY





B801470
26 cm - 10 1/4"

SIMON

MARTIN

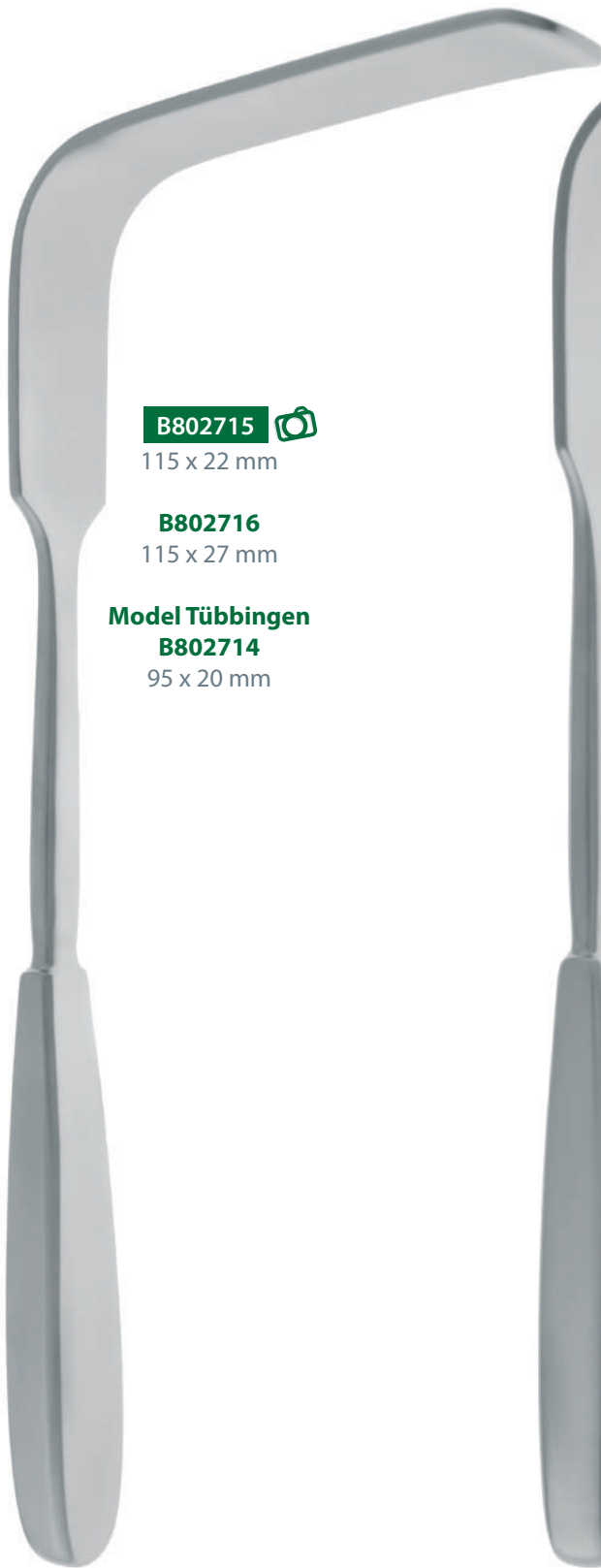
SAUERBRUCH



B802715 

115 x 22 mm

B802716

115 x 27 mm

Model Tübingen

B802714

95 x 20 mm

B802715

28 cm - 11"



B802717

105 x 27 m

B802896

45 x 15 mm

B802897 

60 x 23 mm

B802898

72 x 20 mm

B802897

22,5 cm - 8 ³/₄"



MORRIS



B802919

70 x 40 mm

B802920

70 x 50 mm

B802921 

70 x 65 mm

B802921

21 cm - 8 1/4"



B802934 

38 x 50 mm

32 x 50 mm

B802935

50 x 50 mm

45 x 50 mm

B802936

65 x 50 mm

38 x 50 mm

B802934

24 cm - 9 1/2"

SAUERBRUCH

CORYLLOS

130 x 38 mm



B802940
26 cm - 10 1/4"

B802939
23 cm - 9"

115 x 67 mm

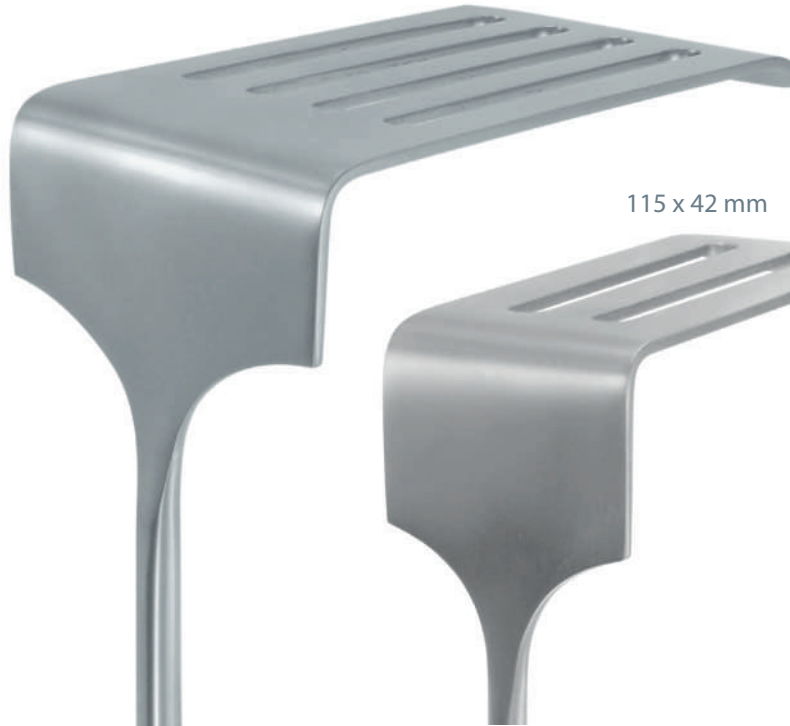

B802938

115 x 42 mm



B802937

82 x 22 mm



MIKULICZ

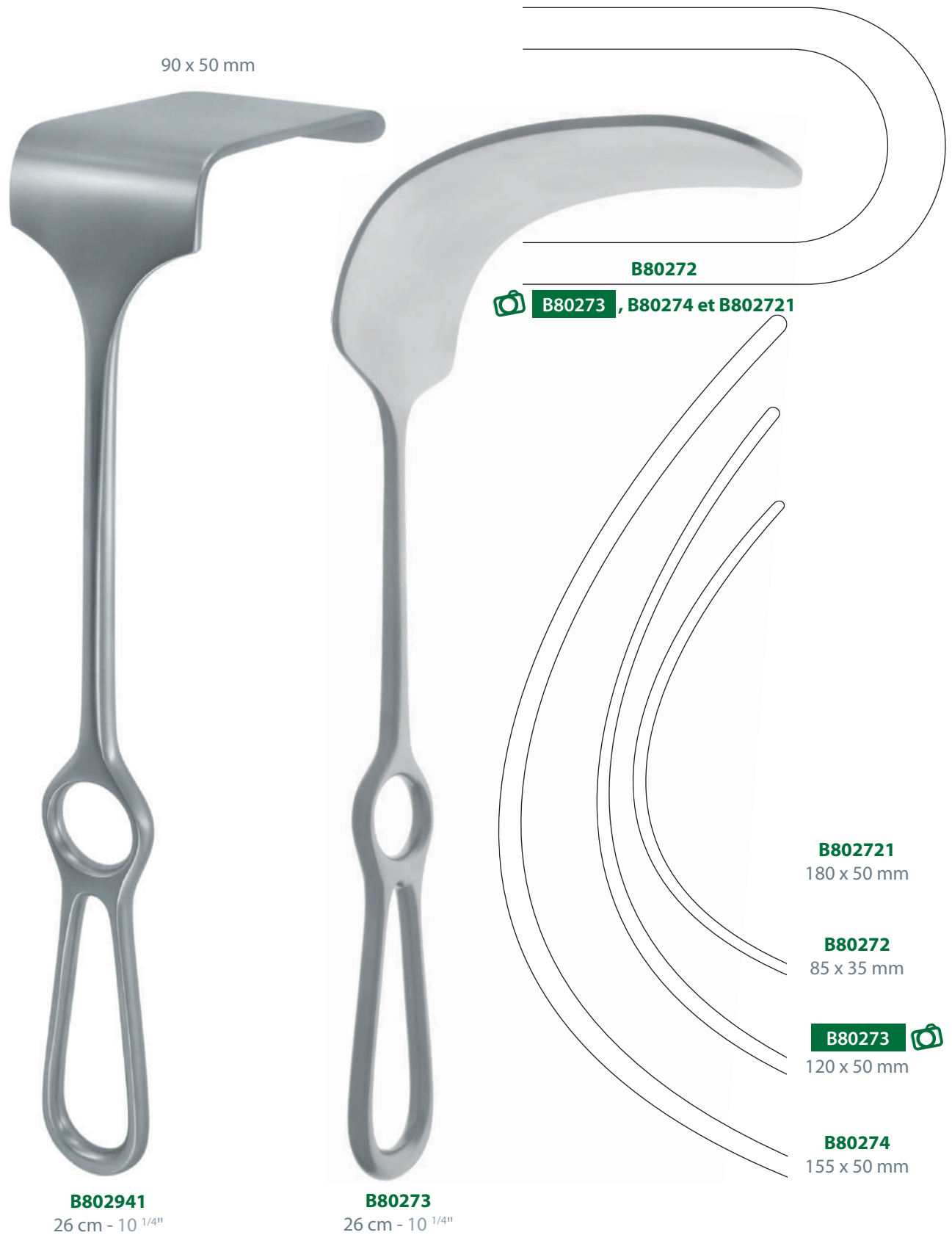

KELLY



B802711

160 x 38 mm

B802712

160 x 57 mm

B802719 

190 x 38 mm

B802742

190 x 57 mm

B802719

27 cm - 10 1/2"



KADER



B802942 

20 mm

B802943

30 mm

B802944

40 mm

B802942

27 cm - 10 1/2"

SEGOND

140 x 35 mm



B802945

31 cm - 12 1/4"

ARNOUS

B802947 

18 mm

B802948

26 mm



B802947

23 cm - 9"

POLOSSON

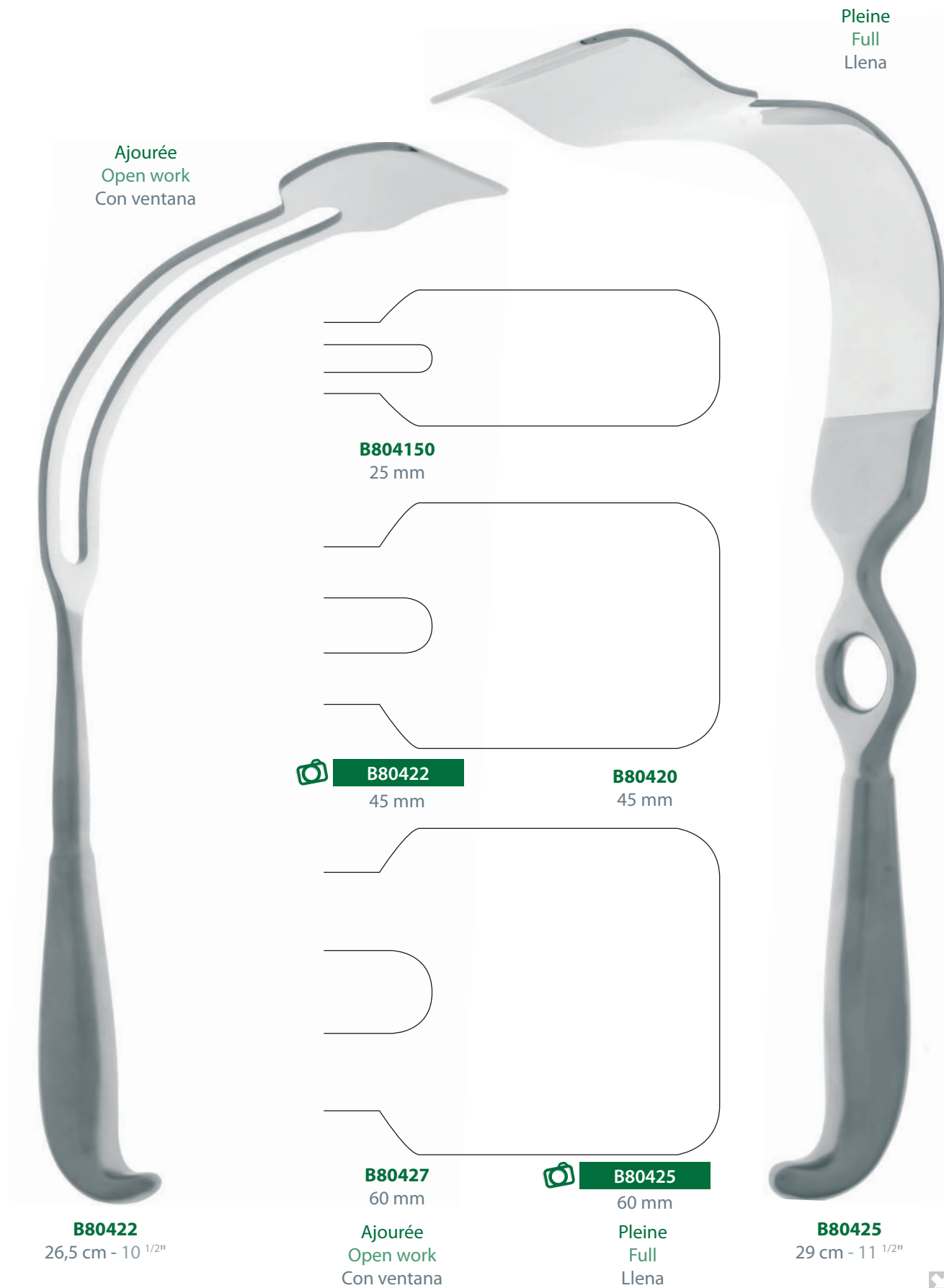

LANDANGER

Valves - Blades - Valvas

LERICHE - BUGATTI

Largeur Très grande courbure
Width Very long curvature
Anchura Curva muy grande

L : 39 cm - 15¹/₃"

48 mm

B804285

OBESE

L : 21 cm - 8¹/₄"

90 mm

B804280

LERICHE

Largeur Petite courbure Moyenne Grande courbure
Width Short curvature Medium Long curvature
Anchura Curva pequeña Medio Curva grande

L : 21 cm - 8¹/₄"

L : 26 cm - 10¹/₄"

L : 30 cm - 12"

35 mm 

B80435

B804422

B80443

45 mm

B80440

B804424

B80444

60 mm

B80442

B804426

B80445

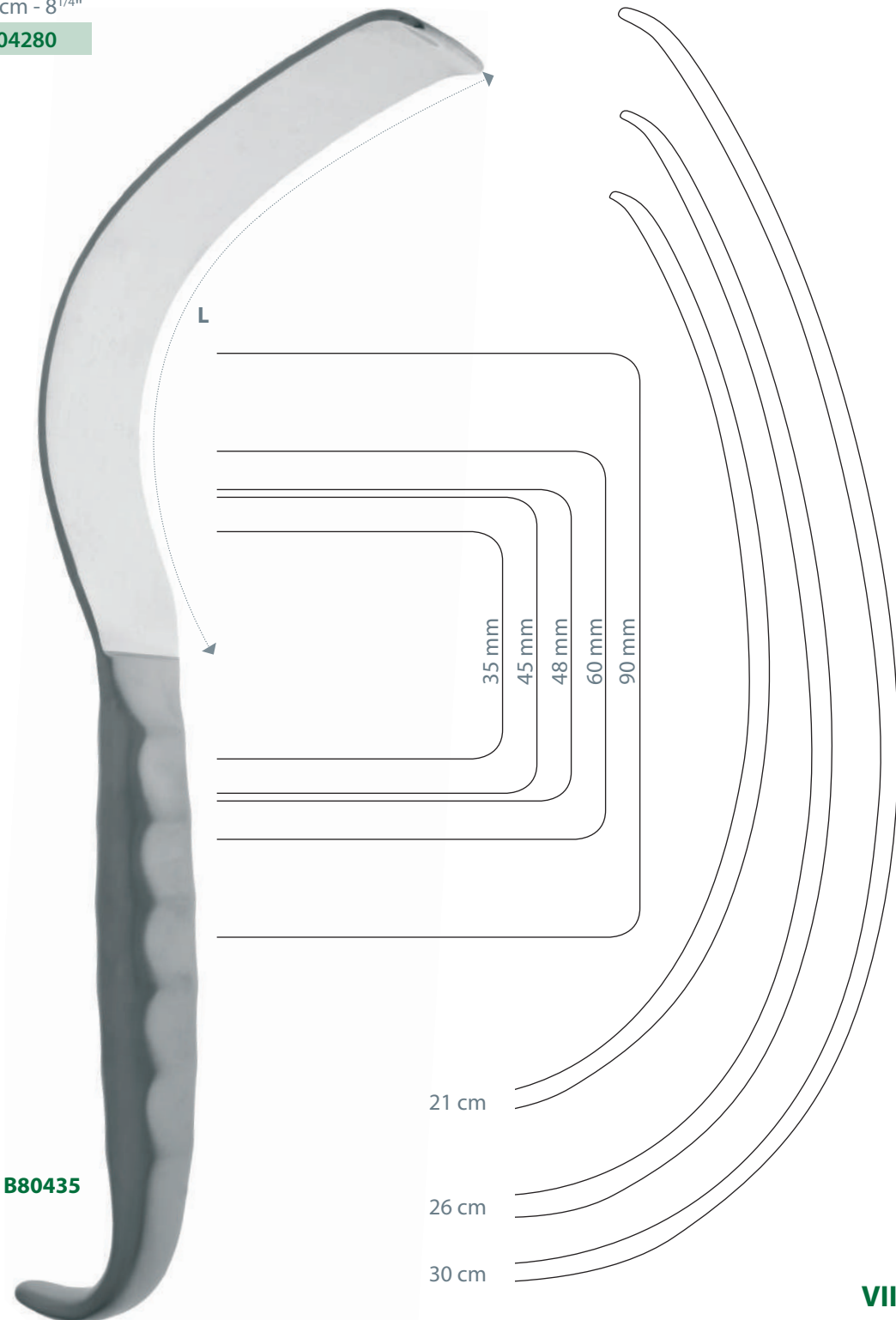

HARRINGTON

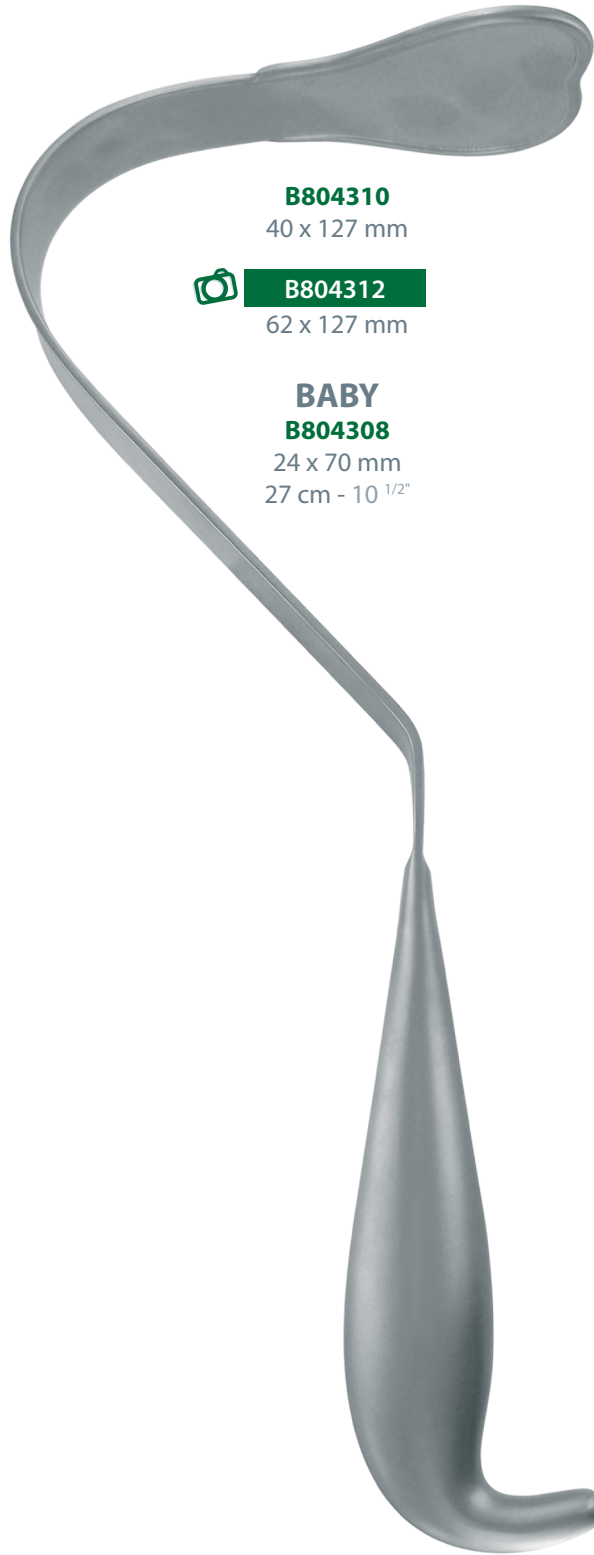

B804310

40 x 127 mm



B804312

62 x 127 mm

BABY

B804308

24 x 70 mm

27 cm - 10 1/2"

B804312

32 cm - 12 1/2"

HARRINGTON-PEMBERTON



64 x 175 mm

B804320

32 cm - 12 1/2"

DEAVER

	Largeur Width Anchura	Longueur Lenght Longitud
 B804460	19 mm	18 cm - 7"
B804461	22 mm	22 cm - 8 ³ / ₄ "
B804462	25 mm	23 cm - 9"
B804463	25 mm	30 cm - 11 ³ / ₄ "
B804464	25 mm	33 cm - 13"
B804465	25 mm	36 cm - 14 ¹ / ₄ "
B804466	38 mm	30 cm - 11 ³ / ₄ "
B804467	50 mm	30 cm - 11 ³ / ₄ "
B804468	75 mm	30 cm - 11 ³ / ₄ "



B804460
18 cm - 7"

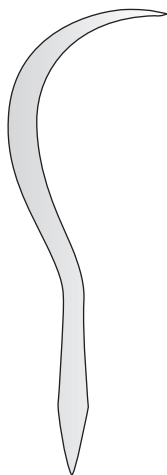

B804460
18 cm - 7"

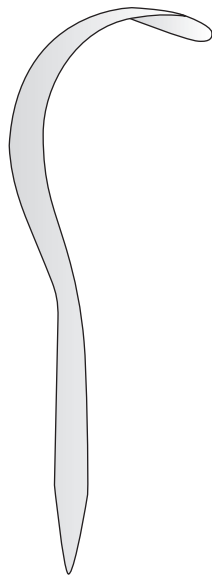

B804461
22 cm - 8 ³/₄"

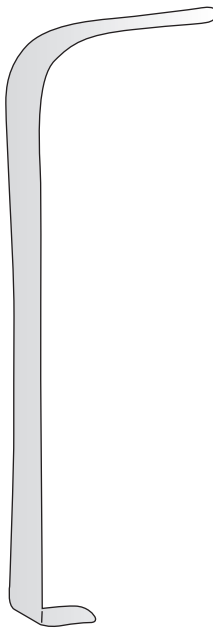

B804462
23 cm - 9"



B804463
30 cm - 11 ³/₄"



B804466
30 cm - 11 ³/₄"



DEAVER



B804470
25 mm

 **B804471**
38 mm

B804472
50 mm

B804473
75 mm

Manche grip
Grip handle
Mango grip

B804471
30 cm - 11 3/4"

LEGUEU



35 mm

28 mm

Pour prostate
For prostate
Para prostate

B804590
27 cm - 10 1/2"

B804600
36 cm - 14 1/4"

FRITSCH

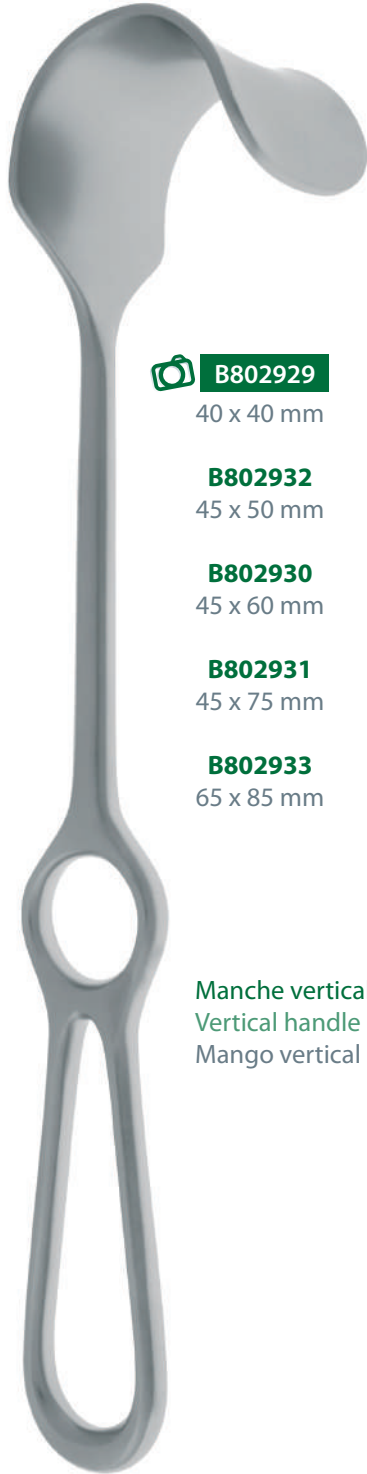

 **B802929**

40 x 40 mm

B802932

45 x 50 mm

B802930

45 x 60 mm

B802931

45 x 75 mm

B802933

65 x 85 mm

Manche vertical
Vertical handle
Mango vertical

B802929

24 cm - 9 1/2"

MIDDELDORPF



 **B802926**

45 x 45 mm

B802927

45 x 50 mm

B802928

55 x 70 mm

B802926

27,5 cm - 10 3/4"

DOYEN



50 x 85 mm

B802949

25 cm - 10"

MIDDELDORPF

GREEN

CUSHING



B802917
14 x 17 mm
22 cm - 8 3/4"

B802922 
21 x 22 mm
22 cm - 8 3/4"

B802923
26 x 30 mm
23,5 cm - 9 1/4"



B802918
14 x 17 mm
22 cm - 8 3/4"

B802924 
21 x 22 mm
22 cm - 8 3/4"

B802925
26 x 30 mm
23,5 cm - 9 1/4"



22 x 22 mm

B802946
22 cm - 8 3/4"



11 x 30 mm

B803290
20 cm - 8"

Manche vertical
Vertical handle
Mango vertical

OBWEGESER

CHIRURGIE MAXILLO-FACIALE
MAXILLOFACIAL SURGERY
CIRUGIA MAXILO-FACIAL

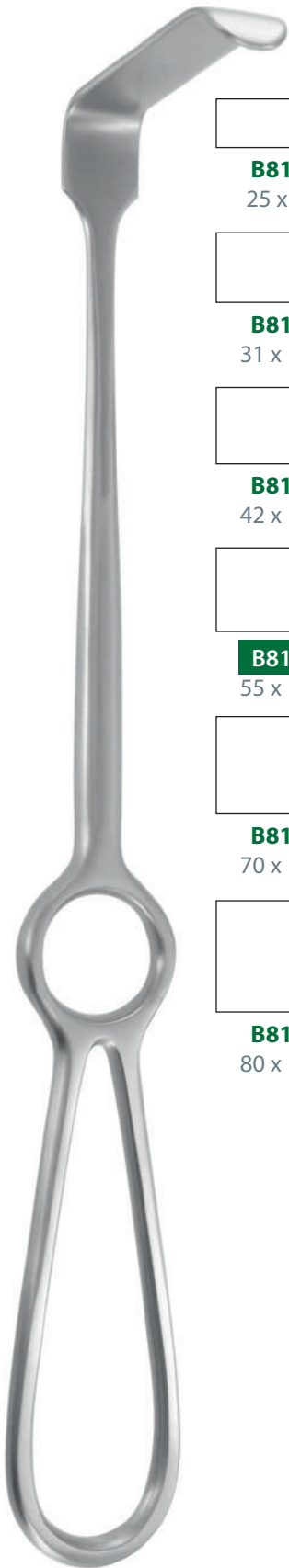

B813000
25 x 7 mm



B813001
31 x 10 mm



B813002
42 x 11 mm



B813003 
55 x 12 mm

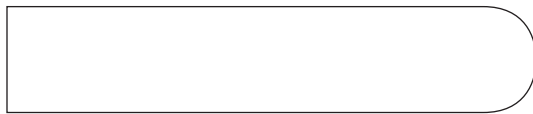

B813004
70 x 14 mm



B813005
80 x 16 mm



B813012
42 x 13 mm



 **B813013**
60 x 12 mm



B813015
80 x 16 mm



B813013
22 cm - 8 3/4"

B813003
22 cm - 8 3/4"



KIRSCH

DOCKHORN

CHIRURGIE MAXILLO-FACIALE
MAXILLOFACIAL SURGERY
CIRUGIA MAXILO-FACIAL



 **B813020 + B813021**
60 x 10 mm

 **B813020**
Gauche
Left
Izquierda

B813021
Droit
Right
Derecha



 **B813030**
40 x 12 mm

B813031
55 x 14 mm

B813020
20 cm - 8"

B813030
20 cm - 8"

SPINA-NASALIS



44 x 9,5 mm



B813040

22 cm - 8 3/4"

RAMUS

CHIRURGIE MAXILLO-FACIALE
MAXILLOFACIAL SURGERY
CIRUGIA MAXILO-FACIAL



70 x 11,5 mm



B813041

22 cm - 8 3/4"

OBWEGESER

8 mm



B813050

15,5 cm - 6"



B813055

17,5 cm - 7"

TESSIER

CHIRURGIE MAXILLO-FACIALE
MAXILLOFACIAL SURGERY
CIRUGIA MAXILO-FACIAL

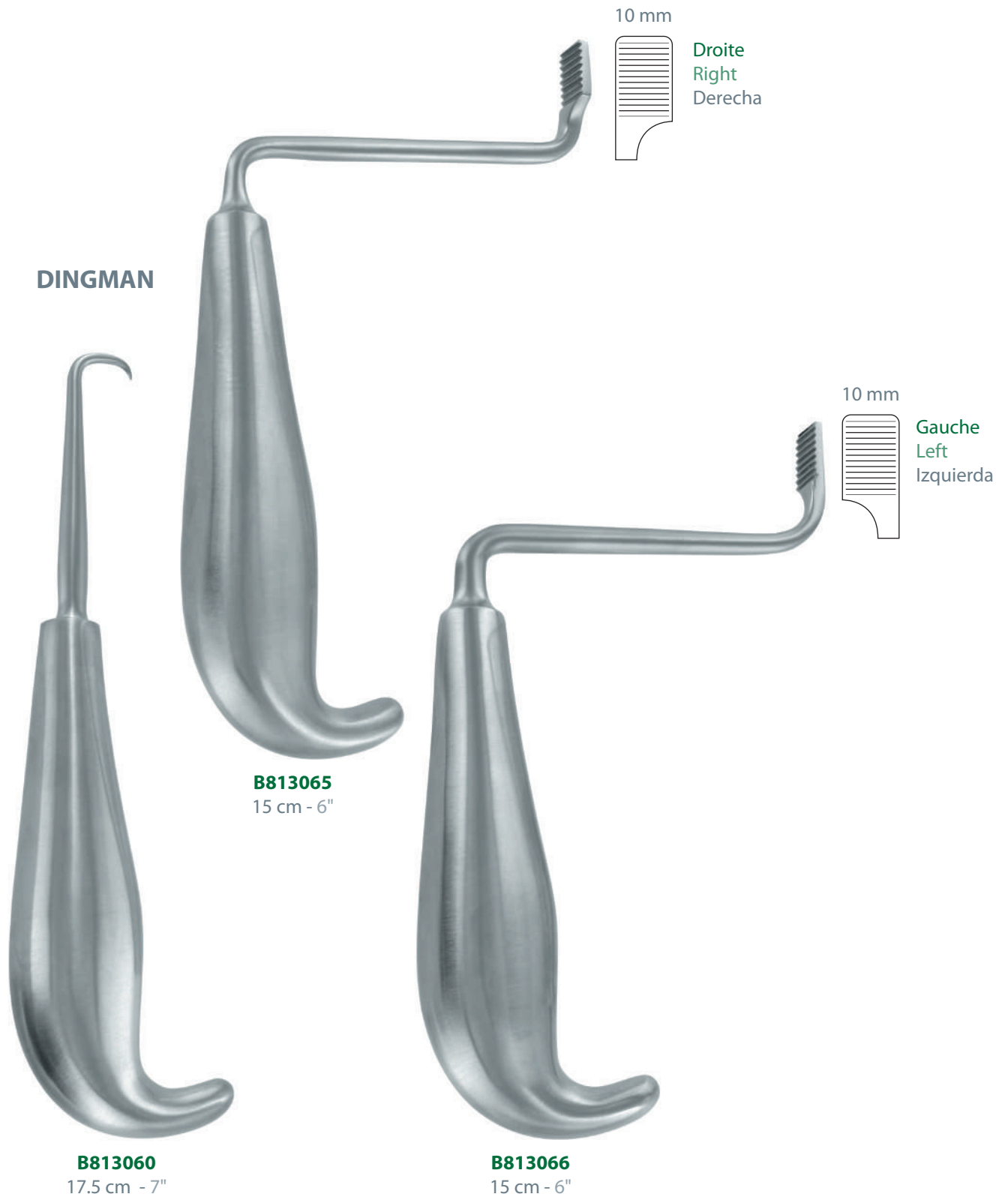

ROCHARD

20 cm - 8"  **B805910**
26 cm - 10 1/4" **B805920**

Compas seul
Compass only
Compas sólo



B80590
19 cm - 7 1/2"

Rallonge
Extension
Extension



B805910
20 cm - 8"



ROCHARD

Valve sus-pubienne
Top pubic blade
Valva para abajo del pubis

	P	L
 B80605	40 mm	80 mm
B80610	50 mm	100 mm
B80615	55 mm	120 mm
B806152	55 mm	135 mm
B806154	50 mm	155 mm

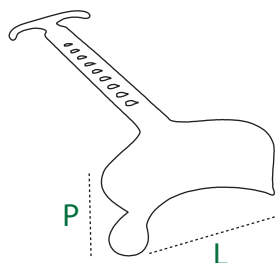

B80605

	P	L
 B80601	50 mm	100 mm

Valve radio transparente
Radioluscent blade
Valva radio transparente

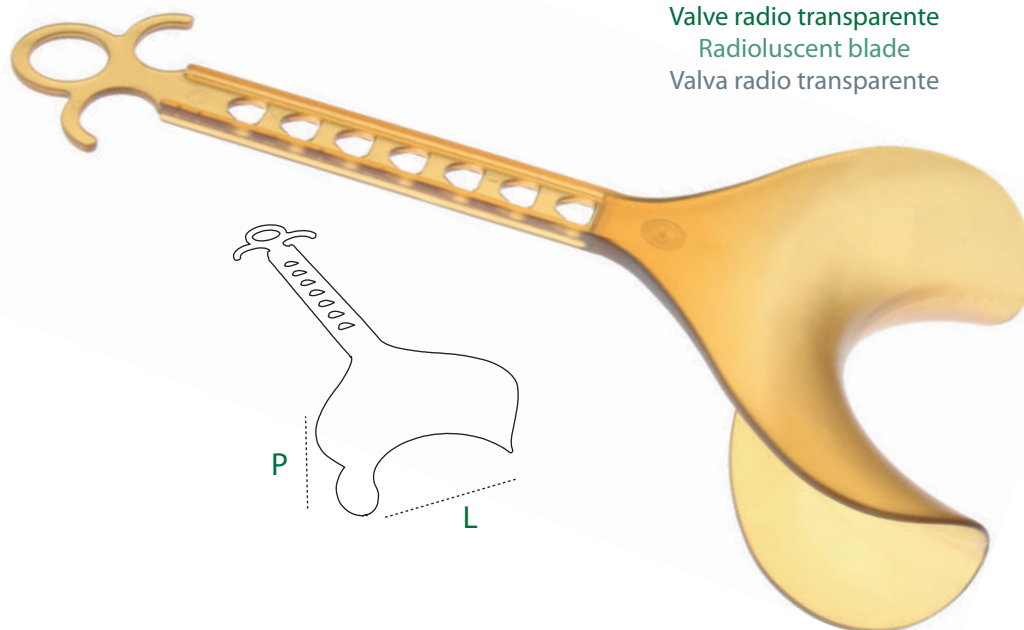
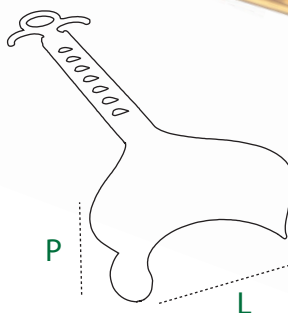

O : Ouverture - Blades opening - Abertura de las hojas
P : Profondeur - Depth - Profundidad
L : Largeur - Width - Anchura

DOYEN-ROCHARD

Valve sus-pubienne
Top pubic blade
Valva para abajo del pubis

	P	L
 B80607	45 mm	80 mm
B80612	50 mm	100 mm
B80617	65 mm	120 mm

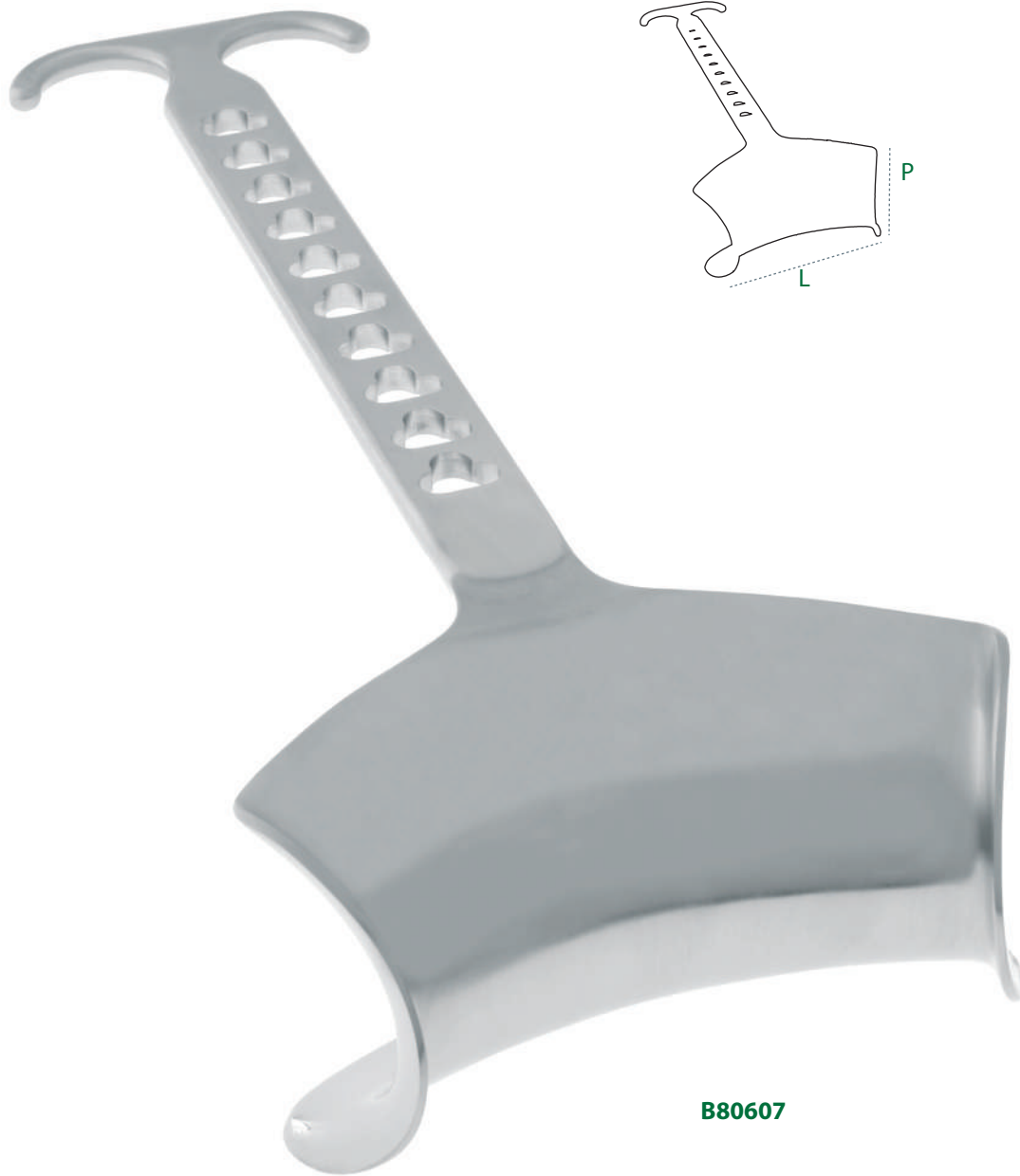

B80607

O : Ouverture - Blades opening - Abertura de las hojas
P : Profondeur - Depth - Profundidad
L : Largeur - Width - Anchura

DESMARET

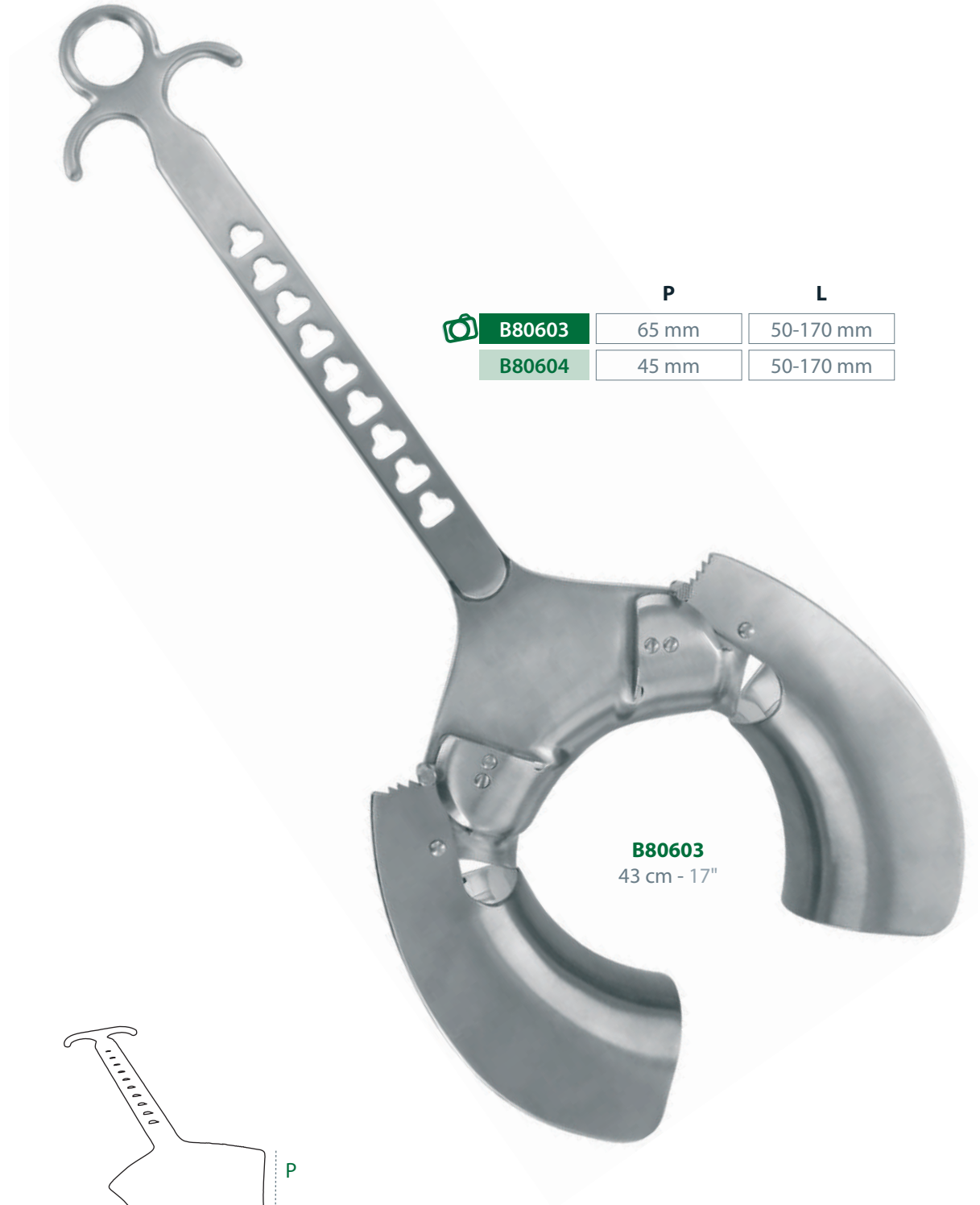

	P	L
 B80603	65 mm	50-170 mm
B80604	45 mm	50-170 mm

B80603
43 cm - 17"

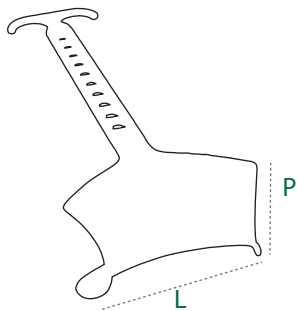

LANDANGER

Écarteurs VK - VK Retractors - Separadores VK

FOUCAULT

	P	L
B806187	50 mm	100 mm



B806187
30 cm - 12"

	P	L
B806178	35 mm	85-110 mm



B806178
26 cm - 10 1/4"



B806185
34,5 cm - 13 1/2"
30 mm

Valve Malléable avec curseur
Malleable balde with cursor
Valva maleable con cursor



B806188
1 m - 39"

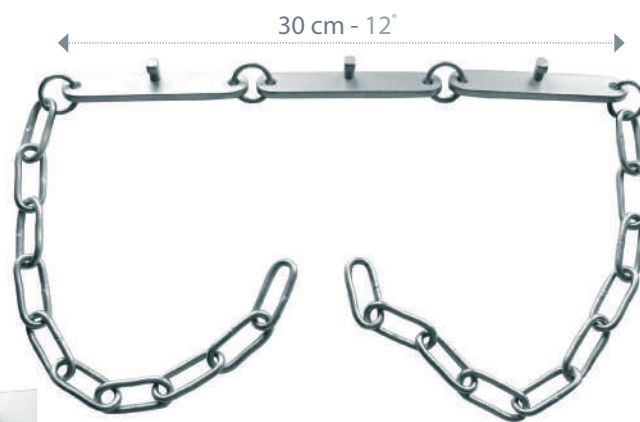

B806189
1 m - 39"



O : Ouverture - Blades opening - Abertura de las hojas
P : Profondeur - Depth - Profundidad
L : Largeur - Width - Anchura

HAUTEFEUILLE

TOUPET

BERGERET TOUPET

Piquet (Paire)
Peg (Par)
Estraca (Pair)



B808410
ø 16 mm
40 cm - 15 3/4"

Piquet (Paire)
Peg (Par)
Estraca (Pair)

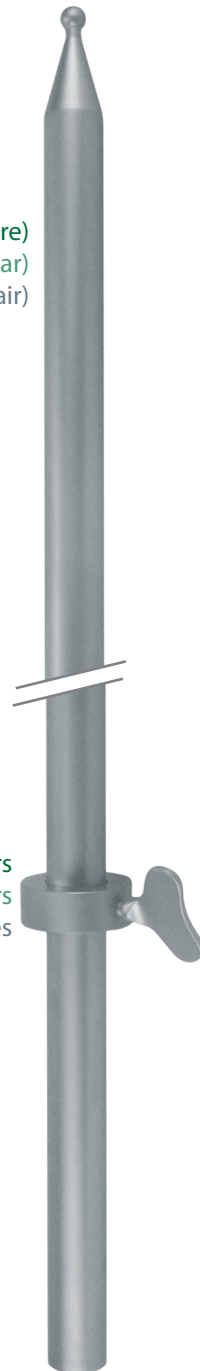

Avec curseurs
With cursors
Con cursores

B80840
ø 16 mm
60 cm - 23 1/2"

Porte-piquet (Paire)
Peg holder (Par)
Porta estraca (Pair)



B808085
ø 16 mm
38 cm - 15"

Chaine avec curseur
Chain with cursor
Cadena con cursor



B80618
100 cm - 39 1/2"

Chaine sans curseur (Paire)
Chain without cursor (Par)
Cadena sin cursor (Pair)



B80835
100 cm - 39 1/2"

Curseur seul
Cursor only
Cursor sólo



B808340
60 mm - 2 1/4"

Maillon rapide
Quick ring
Anillo rápido



B808360
40 mm - 1 1/2"



RICARD

Valves latérales (à l'unité)
Lateral blades (per unit)
Valvas laterales (la unidad)



P **L**

 B80645	50 mm	60 mm
B80650	65 mm	80 mm
B80655	80 mm	100 mm
B80660	100 mm	120 mm



Valve médiane
Center blade
Valva mediana

P **L**

 B80665	50 mm	60 mm
B80670	65 mm	80 mm
B80675	80 mm	100 mm
B80680	100 mm	120 mm

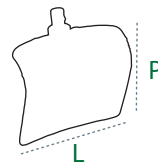

Compas seul
Compass only
Compas sólo



Ouverture maxi 300mm
Blade opening 11 3/4"
Abertura total 300 mm

B80640
18 cm - 7"

TOUPET

Valves latérales (paire)
Lateral blades (pair)
Valvas laterales (par)



P **L**

 B80806	70 mm	40 mm
B80807	50 mm	40 mm

O : Ouverture - Blades opening - Abertura de las hojas
P : Profondeur - Depth - Profundidad
L : Largeur - Width - Anchura



RICARD-BEGOIN

Compas seul
Compass only
Compas sólo



Ouverture maxi 300 mm
Blade opening 11 ³/₄"
Abertura total 300 mm

B80640
18 cm - 7"

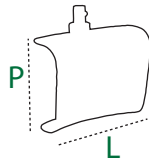

Valves latérales (à l'unité)
Lateral blades (per unit)
Valvas laterales (la unidad)



	P	L
 B80705	50 mm	60 mm
B80710	70 mm	80 mm
B80715	75 mm	100 mm
B80720	95 mm	120 mm

Valve médiane
Center blade
Valva mediana



	P	L
B80725	55 mm	60 mm
 B80730	75 mm	80 mm
B80735	110 mm	100 mm
B80740	120 mm	120 mm

O : Ouverture - Blades opening - Abertura de las hojas
P : Profondeur - Depth - Profundidad
L : Largeur - Width - Anchura



RICARD

Complet avec 3 valves
Complete with 3 blades
Completo con 3 valvas

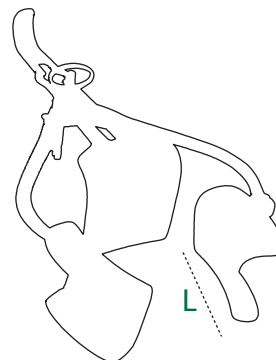

B80620
60 mm

L

60 mm 	B80620	= B80640 + 2 x B80645 + B80665
80 mm	B80625	= B80640 + 2 x B80650 + B80670
100 mm	B80630	= B80640 + 2 x B80655 + B80675
120mm	B80635	= B80640 + 2 x B80660 + B80680

RICARD-BEGOIN

B80685
60 mm

L

60 mm 	B80685	= B80640 + 2 x B80705 + B80725
80 mm	B80690	= B80640 + 2 x B80710 + B80730
100 mm	B80695	= B80640 + 2 x B80715 + B80735
120 mm	B80700	= B80640 + 2 x B80720 + B80740

O : Ouverture - Blades opening - Abertura de las hojas

P : Profondeur - Depth - Profundidad

L : Largeur - Width - Anchura

TOUPET

Adaptable sur compas de Ricard
Use with Ricard compass
Se utiliza con compas de Ricard

Dépresseur double
Double depressor
Valva doble



	P	L
B80745	90 mm	155 mm

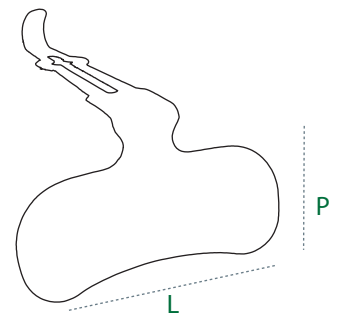

B80745
205 mm - 8"

TOUPET (ENTEROSTAT)

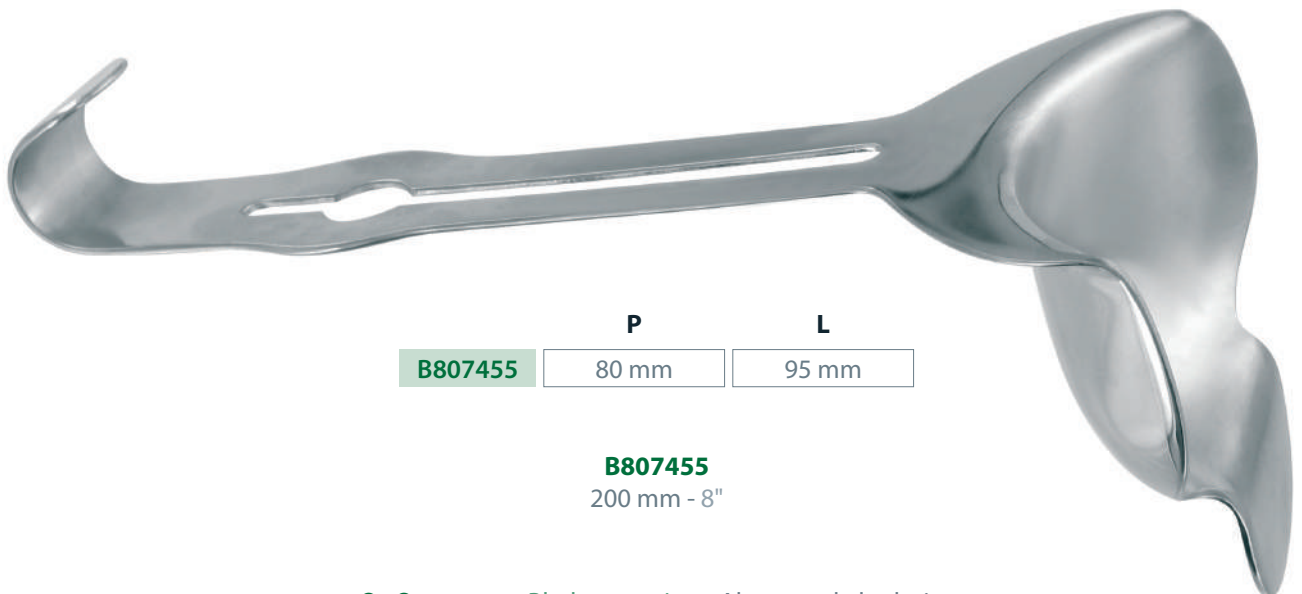

	P	L
B807455	80 mm	95 mm

B807455
200 mm - 8"

O : Ouverture - Blades opening - Abertura de las hojas
P : Profondeur - Depth - Profundidad
L : Largeur - Width - Anchura



COTT

Valves latérales (à l'unité)
Lateral blades (per unit)
Valvas laterales (la unidad)



P L

B807580	40 mm	50 mm
B80759	45 mm	75 mm
B80760	55 mm	75 mm

Compas seul
Compass only
Compas sólo



B807610
20 cm - 8"

B807620
25 cm - 10"

B80763
30 cm - 11 ^{3/4}"

Valve médiane
Center blade
Valva mediana

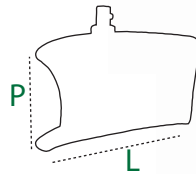

P L

B80765	65 mm	75 mm
---------------	-------	-------

Complet avec 2 valves latérales et 1 valve médiane
Complete with 2 lateral blades and 1 center blade
Completo con 2 valvas laterales y 1 valva mediana

B80755 = B80763 + 2 x B80759 + B80765

B80756 = B80763 + 2 x B80760 + B80765

Complet avec 4 valves latérales et 1 valve médiane
Complete with 4 lateral blades and 1 center blade
Completo con 4 valvas laterales y 1 valva mediana

B80750 = B80763 + 2 x B80759 + 2 x B80760 + B80765

O : Ouverture - Blades opening - Abertura de las hojas
P : Profondeur - Depth - Profundidad
L : Largeur - Width - Anchura

PALMER

Complet avec 3 paires de valves latérales de Ricard
 Complete with 3 pairs of Ricard lateral blades
 Completo con 3 pares de valvas laterales de Ricard

B80767 = B80763 + 2 x B80645 + 2 x B80650 + 2 x B80655

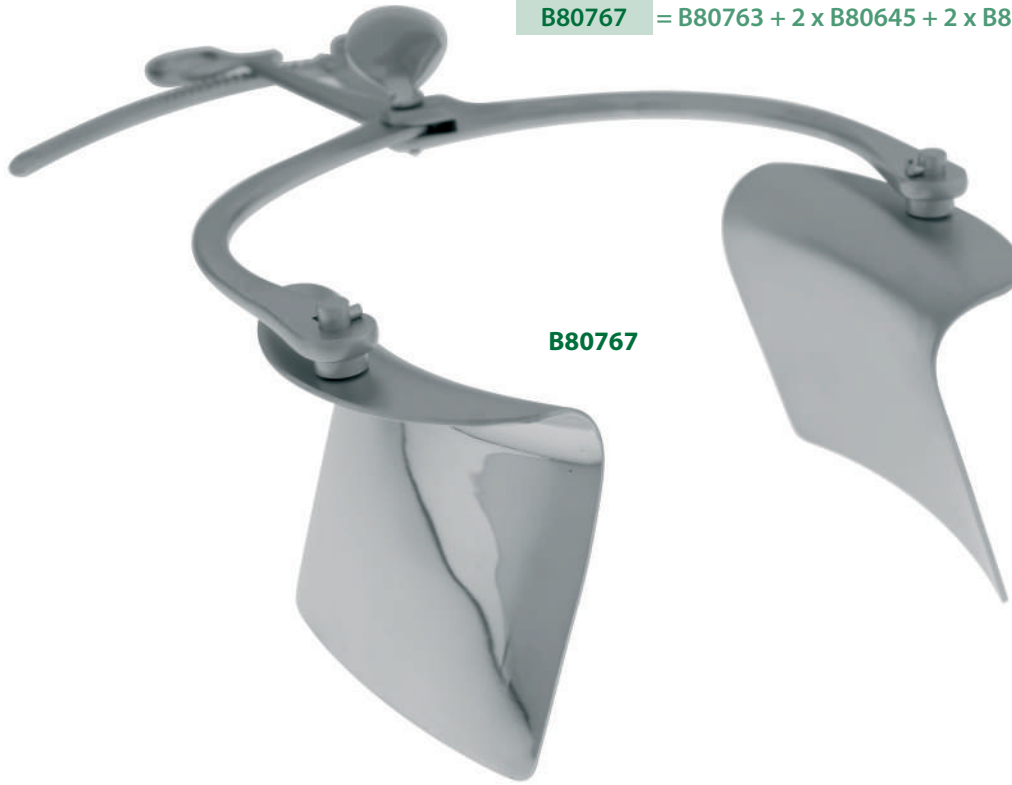

Compas seul
 Compass only
 Compas sólo

B80767

B80763
 30 cm - 11 ³/₄"

Valves latérales (à l'unité)
 Lateral blades (per unit)
 Valvas laterales (la unidad)

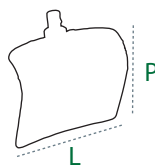

	P	L
 B80645	50 mm	60 mm
 B80650	65 mm	80 mm
 B80655	80 mm	100 mm

O : Ouverture - Blades opening - Abertura de las hojas
 P : Profondeur - Depth - Profundidad
 L : Largeur - Width - Anchura



COLLIN

Valves latérales (à l'unité)
Lateral blades (per unit)
Valvas laterales (la unidad)

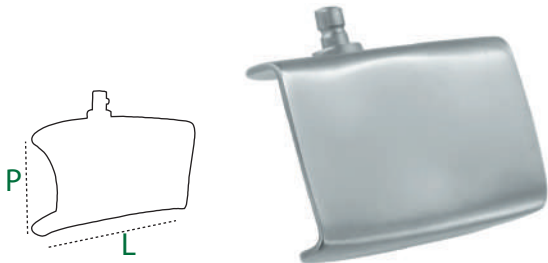

P **L**

B817020	38 mm	60 mm
B817021	38 mm	80 mm
B817022	38 mm	100 mm

Compas seul
Compass only
Compas sólo



B817010
21 cm - 8 1/2"

Valve médiane
Center blade
Valva mediana



P **L**

B817030	55 mm	55 mm
B817031	55 mm	75 mm



Complet avec 2 valves latérales et 1 valve médiane
Complete with 2 lateral blades and 1 center blade
Completo con 2 valvas laterales y 1 valva mediana

B817000	= B817010 + 2 x B817020 + B817030
B817001	= B817010 + 2 x B817021
B817002	= B817010 + 2 x B817022 + B817031

O : Ouverture - Blades opening - Abertura de las hojas
P : Profondeur - Depth - Profundidad
L : Largeur - Width - Anchura



COLLIN

Valves latérales (à l'unité)
Lateral blades (per unit)
Valvas laterales (la unidad)

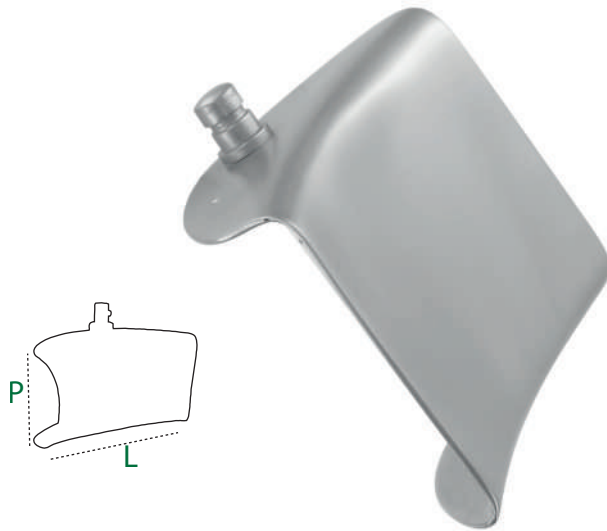

B817120	P	L
	60 mm	80 mm

Compas seul
Compass only
Compas sólo



B817110
25 cm - 10"

Valve médiane
Center blade
Valva mediana



B817130	P	L
	60 mm	75 mm

Complet avec 2 valves latérales et 1 valve médiane
Complete with 2 lateral blades and 1 center blade
Completo con 2 valvas laterales y 1 valva mediana

B817100 = B817110 + 2 x B817120 + B817130

O : Ouverture - Blades opening - Abertura de las hojas
P : Profondeur - Depth - Profundidad
L : Largeur - Width - Anchura

BABY-COLLIN

Valves latérales (à l'unité)
Lateral blades (per unit)
Valvas laterales (la unidad)

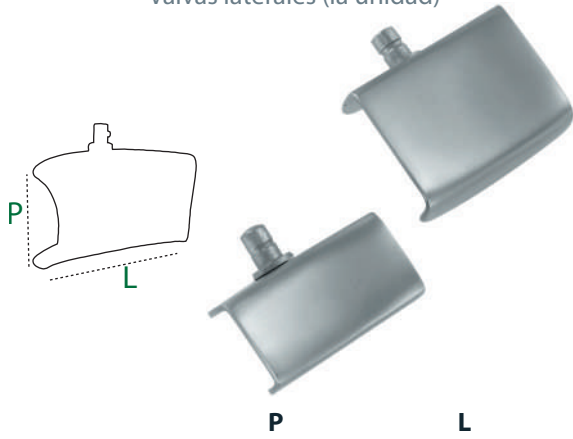

	P	L
B817220	20 mm	40 mm
B817221	30 mm	42 mm

Complet avec 4 valves latérales
Complete with 4 lateral blades
Completo con 4 valvas laterales

B817200 = B817210 + 2 x B817220 + 2 x B817221

MAYO-ADAMS

37 x 15 mm

50 x 15 mm



Avec valve médiane
With central blade
Con valva mediana

B817300
18 cm - 7"



Compas seul
Compass only
Compas sólo

B817210
18 cm - 7"

37 x 15 mm



Sans valve médiane
Without central blade
Sin valva mediana

B817301
18 cm - 7"

O : Ouverture - Blades opening - Abertura de las hojas
P : Profondeur - Depth - Profundidad
L : Largeur - Width - Anchura

OLIVIER

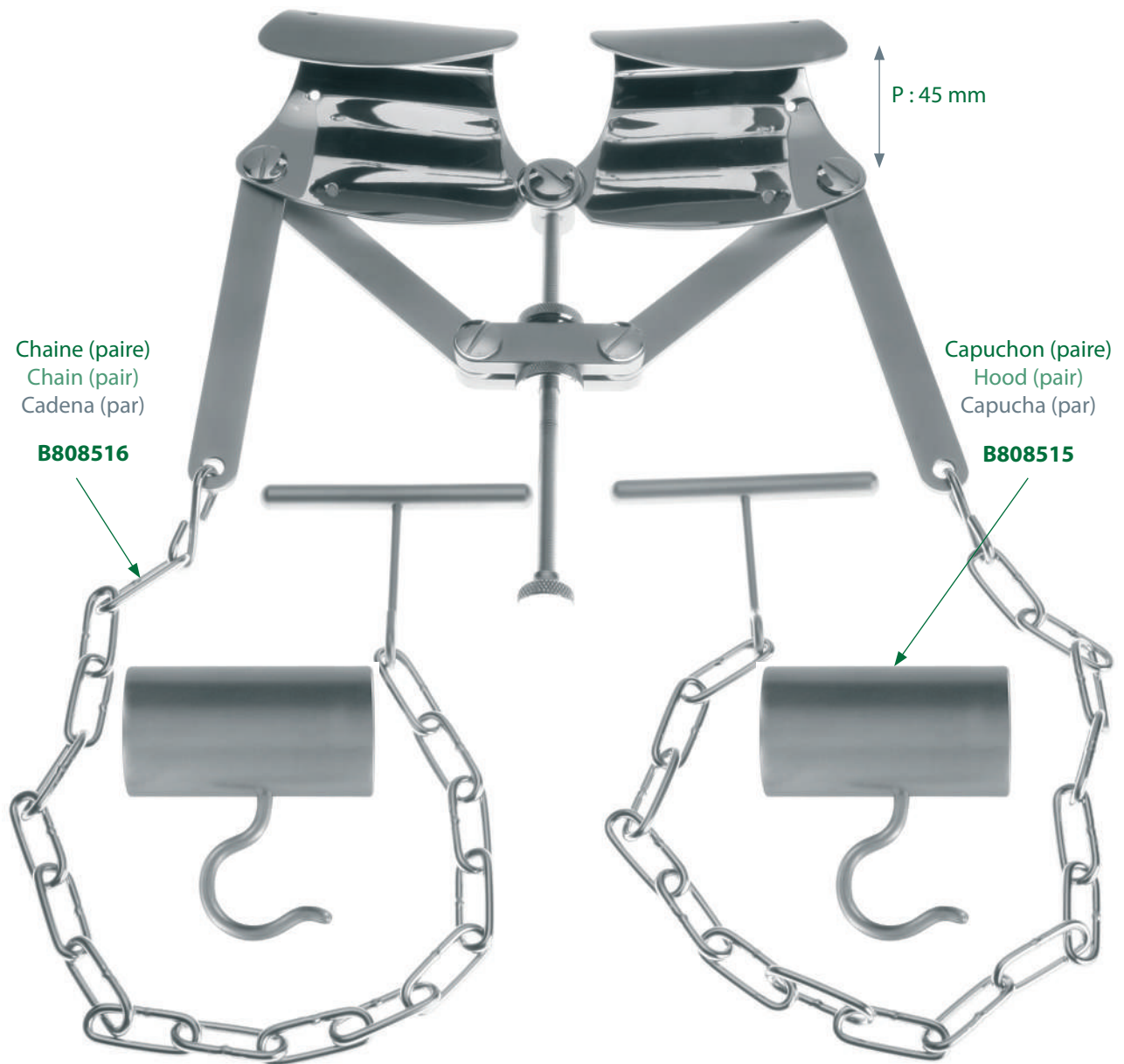

B80850

P : 45 mm

Écarteur complet avec chaînes et capuchons
 Complete retractor with chains and hoods
 Separadore completo con cadenas et capuchas

B808510

P : 107 mm

Écarteur complet avec chaînes et capuchons pour obèse
 Complete retractor with chains and hoods for obese
 Separadore completo con cadenas et capuchas por obeso

O : Ouverture - Blades opening - Abertura de las hojas
 P : Profondeur - Depth - Profundidad
 L : Largeur - Width - Anchura

KIRSCHNER

Cadre pliant avec 2 paires de valves
Foldable frame with 2 pairs of blades
Cuadro plegable con 2 pares de valvas

B80820 = B808209 + 2 B808201 + 2 B808202

Cadre fixe avec 2 paires de valves
Fixed frame with 2 pairs of blades
Cuadro fijo con 2 pares de valvas

B80815 = B808159 + 2 B808201 + 2 B808202

Cadre pliant seul
Foldable frame only
Cuadro plegable solo

B808209

Cadre fixe seul
Fixed frame only
Cuadro fijo solo

B808159

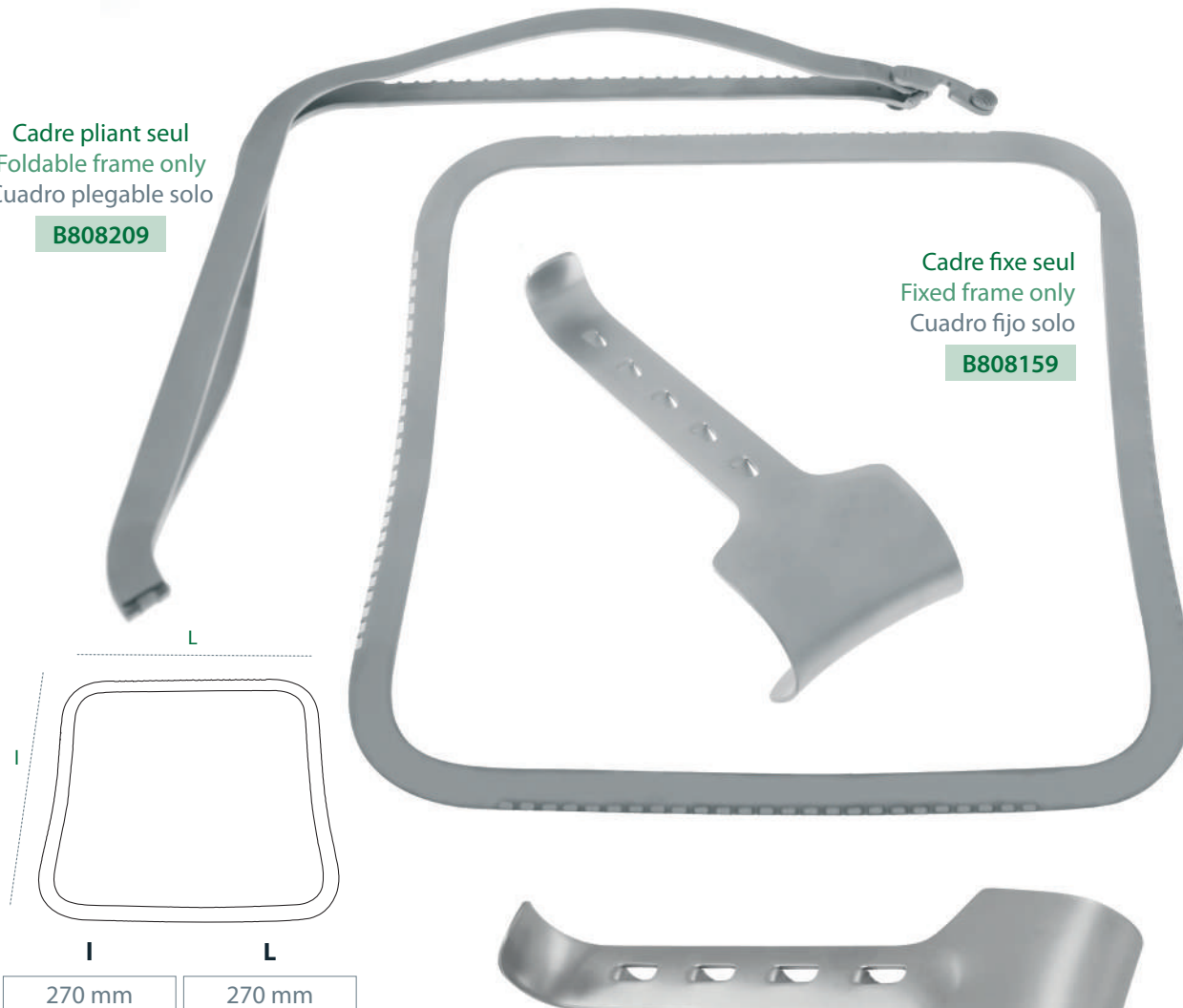

Cadre seul
Frame only
Cuadro solo

Valves seules
Blades only
Valvas sóloas

	P	L
B808201	40 mm	55 mm
B808202	50 mm	65 mm
B808203	65 mm	80 mm
B808204	80 mm	80 mm
B808205	90 mm	65 mm
B808206	90 mm	90 mm

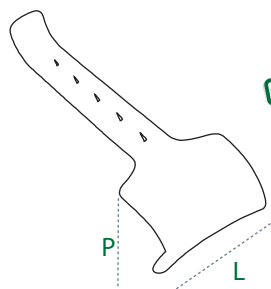

O : Ouverture - Blades opening - Abertura de las hojas

P : Profondeur - Depth - Profundidad

L : Largeur - Width - Anchura

DENIS BROWN

Cadre 178 x 140 mm complet avec 2 paires de valves
 Frame 7" x 5 1/2" complete with 2 pairs of blades
 Cuadro 178 x 140 mm completo con 2 pares de valvas

B808300 = B808310 + 2 x B808312 + 2 x B808313

Cadre 255 x 178 mm complet avec 2 paires de valves
 Frame 10" x 7" complete with 2 pairs of blades
 Cuadro 255 x 178 mm completo con 2 pares de valvas

B808301 = B808311 + 2 x B808312 + 2 x B808313

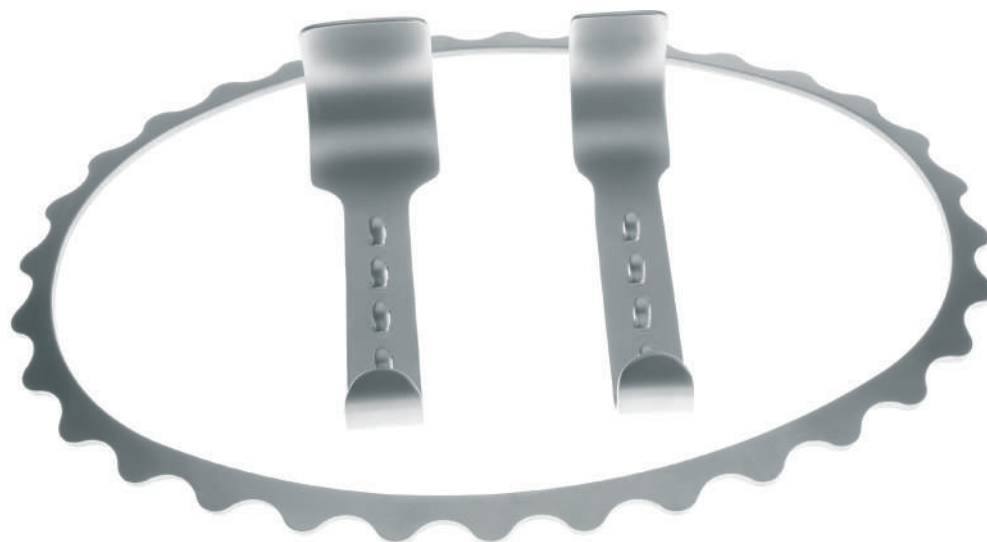

Cadre seul 178 x 140 mm
 Frame only 7 x 5 1/2"
 Cuadro sólo 178 x 140 mm

B808310



Valve seule 40 x 30 mm
 Blade only 1 1/2" x 1 1/8"
 Valva sólo 40 x 30 mm

B808312



Valve seule 40 x 40 mm
 Blade only 1 1/2" x 1 1/2"
 Valva sólo 40 x 40 mm

B808313



Cadre seul 255 x 178 mm
 Frame only 10" x 7"
 Cuadro sólo 255 x 178 mm

B808311



SEMM

Cadre complet
avec 6 valves
Frame complete
with 6 blades
Cuadro completo
con 6 valvas

B808270

Cadre seul
Frame only
Cuadro sólo

B808271

295 x 260 mm

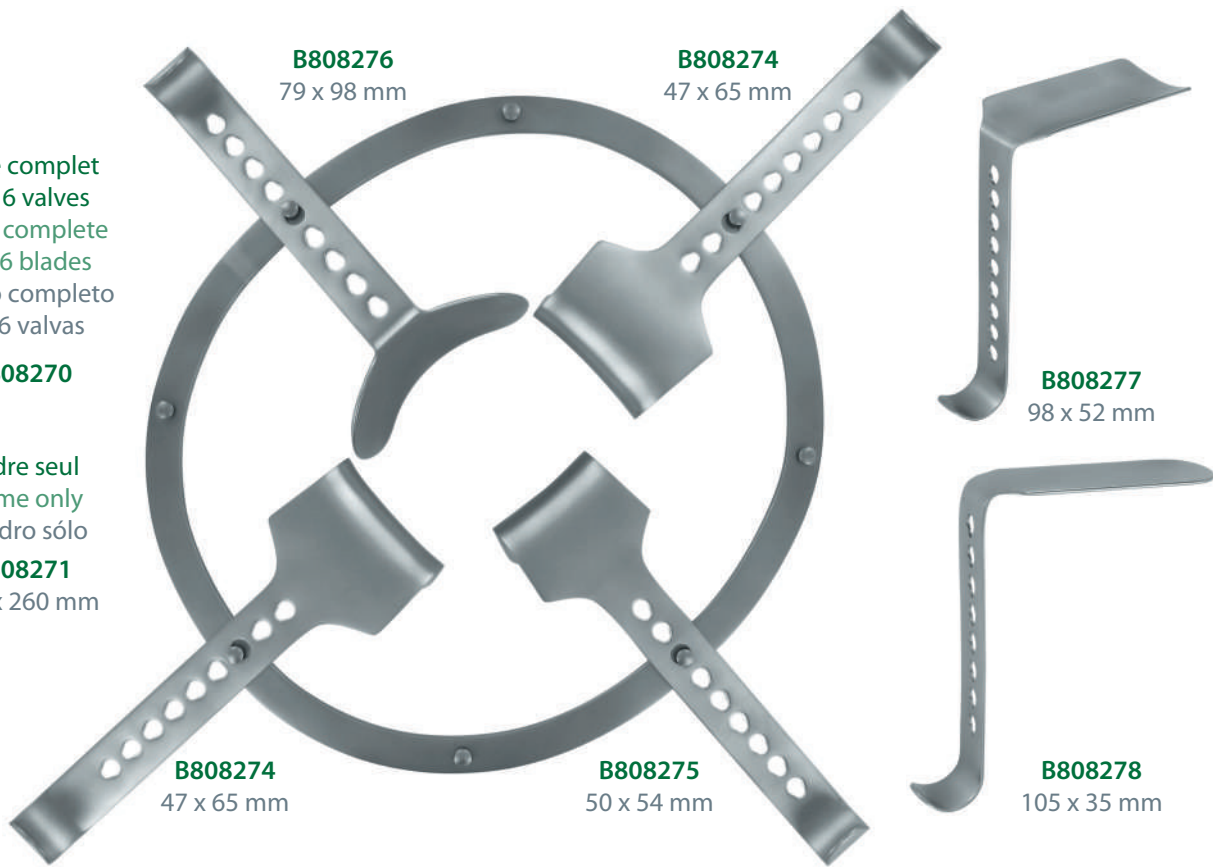

O'SULIVAN - O'CONNOR

Cadre complet
avec 3 valves
Frame complete
with 3 blades
Cuadro completo
con 3 valvas

B808280

2 x **B808285**
80 x 45 mm

68 x 25 mm

68 x 25 mm

1 x **B808286**
110 x 70 mm

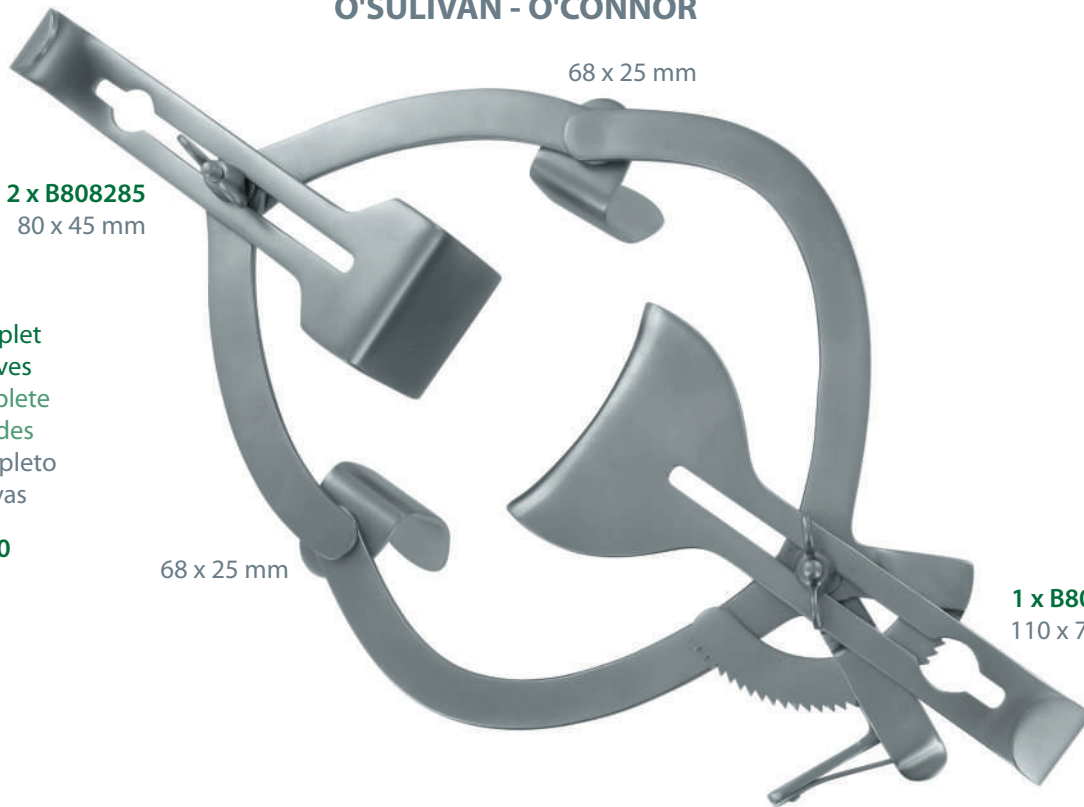

AUVERT

Complet - Complete - Completo

B80810

B808110 + 8 x B80812 + 8 x B80813 + B808133 + B808134 + B808135 + B808136 + 2 x B808137 + 2 x B808138 + 1 x B808139

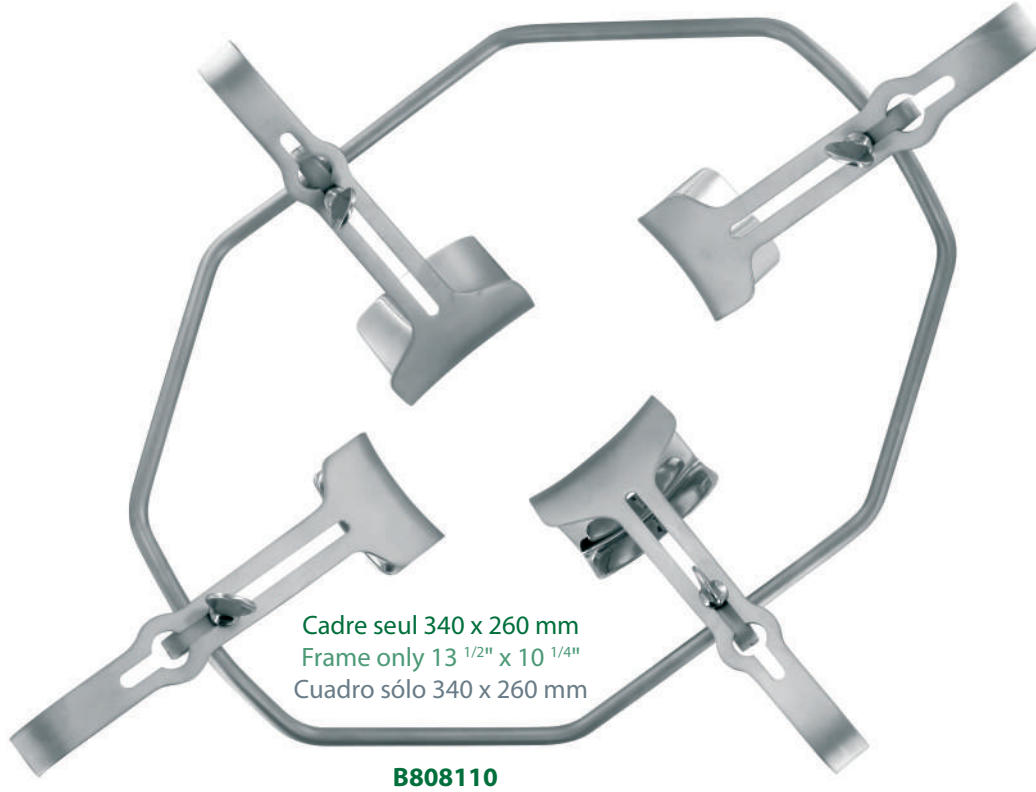

B80813

Vis anneau seule
Ring screw only
Tornillo anillo sólo



B80812

Étau seul
Vice only
Torno sólo

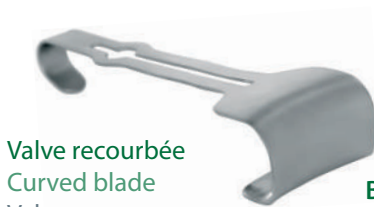

Valve recourbée
Curved blade
Valva curva

B808135

19,5 cm - 7 3/4"

P

L

 B808135	30 mm	60 mm
B808133	50 mm	80 mm

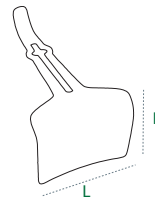

Valve oblique
Oblic blade
Valva oblicuo

B808136

18,5 cm - 7 1/4"

P

L

B808134	50 mm	60 mm
 B808136	65 mm	80 mm



Fer à cintrer (paire)
Blade bender (pair)
Llave para valva (par)

B808139

17 cm - 6 3/4"



Valve malléable
Malleable blade
Valva maleable

B808138

32,5 cm - 12 3/4"

L

B808137	35 mm
 B808138	50 mm

O : Ouverture - Blades opening - Abertura de las hojas

P : Profondeur - Depth - Profundidad

L : Largeur - Width - Anchura

LANDANGER

Écarteurs - Retractors - Separadores

GOSSET

B80476

1 branche mobile
1 mobile arm
1 brazo móvil

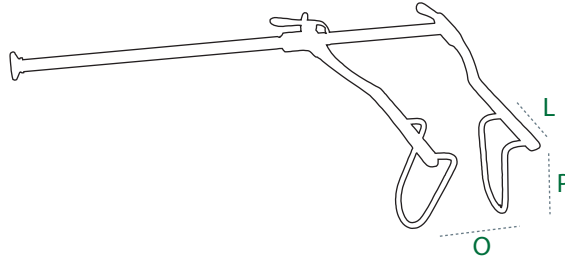

	O	P	L
B80470	120 mm	35 mm	30 mm
B80475	180 mm	60 mm	45 mm
 B80476	250 mm	60 mm	45 mm

MONTESTRUC

 1/3

	O	P	L
B804770	250 mm	120 mm	100 mm

B804770

Valve médiane
Center blade
Valva mediana

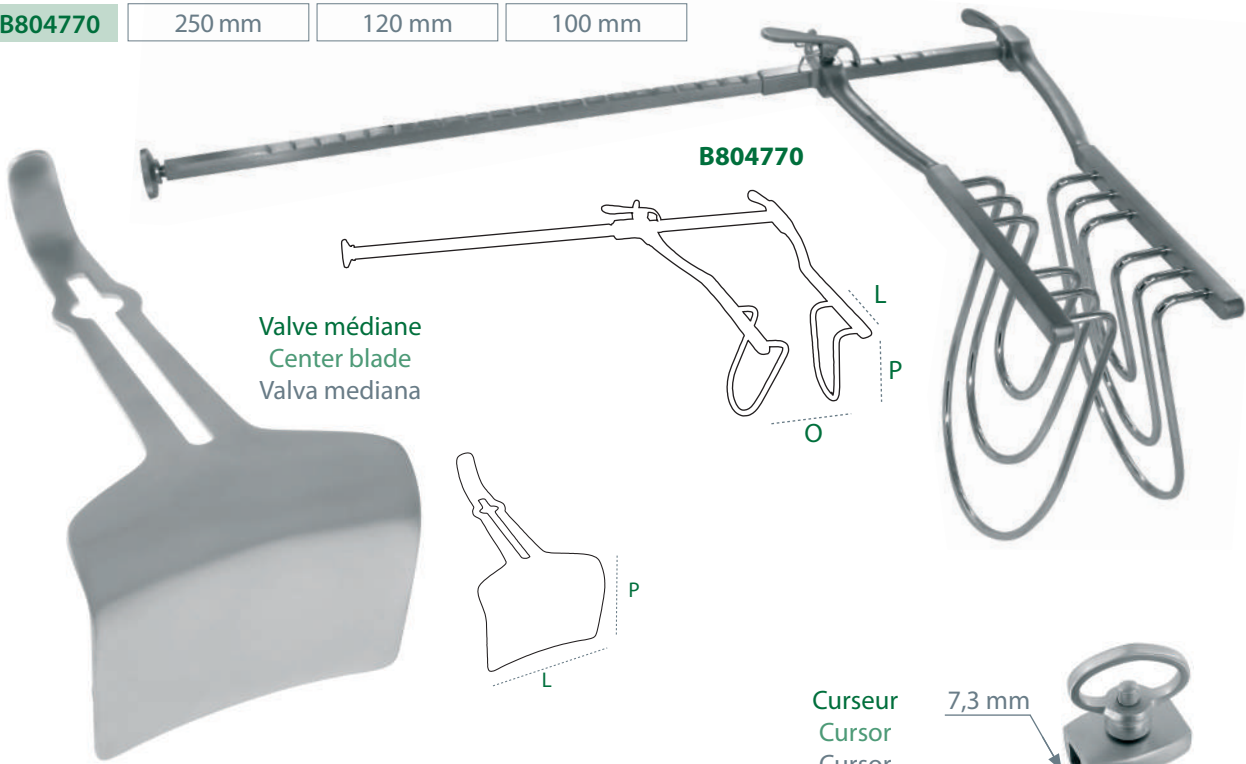

Curseur
Cursor
Cursor

7,3 mm

B80500

	P	L
B80498	65 mm	85 mm

O : Ouverture - Blades opening - Abertura de las hojas
P : Profondeur - Depth - Profundidad
L : Largeur - Width - Anchura

 1/2

VII - Écarteurs
VII - Retractors
VII - Separadores

GOSSET

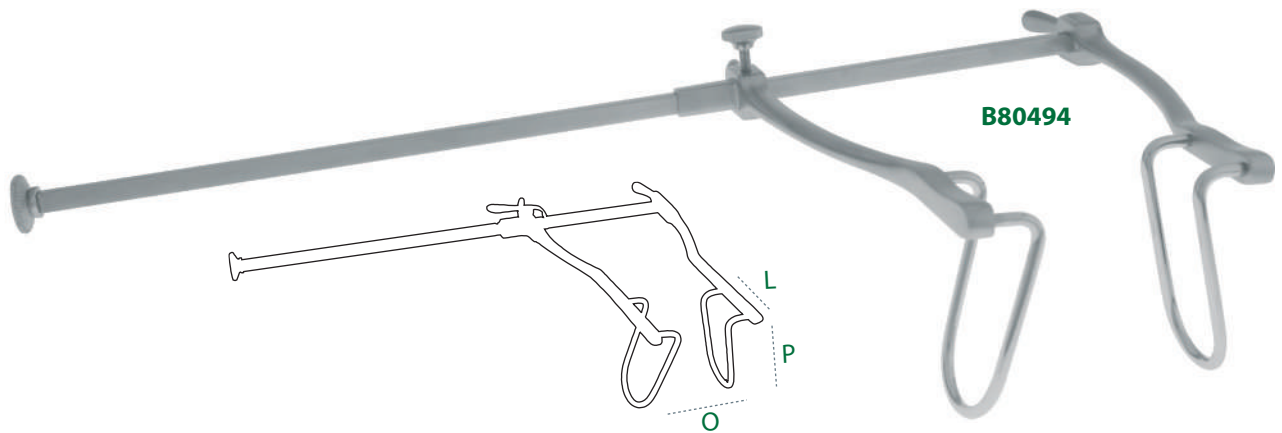

1 branche mobile
1 mobile arm
1 brazo móvil

	O	P	L
B80486	75 mm	25 mm	22 mm
B80488	120 mm	35 mm	30 mm
B804900	180 mm	60 mm	45 mm
B80494	280 mm	60 mm	45 mm



Valve médiane
Center blade
Valva mediana

B80498	P 65 mm	L 85 mm
---------------	------------	------------

Curseur
Cursor
Cursor



B80500

O : Ouverture - Blades opening - Abertura de las hojas
P : Profondeur - Depth - Profundidad
L : Largeur - Width - Anchura

BALFOUR

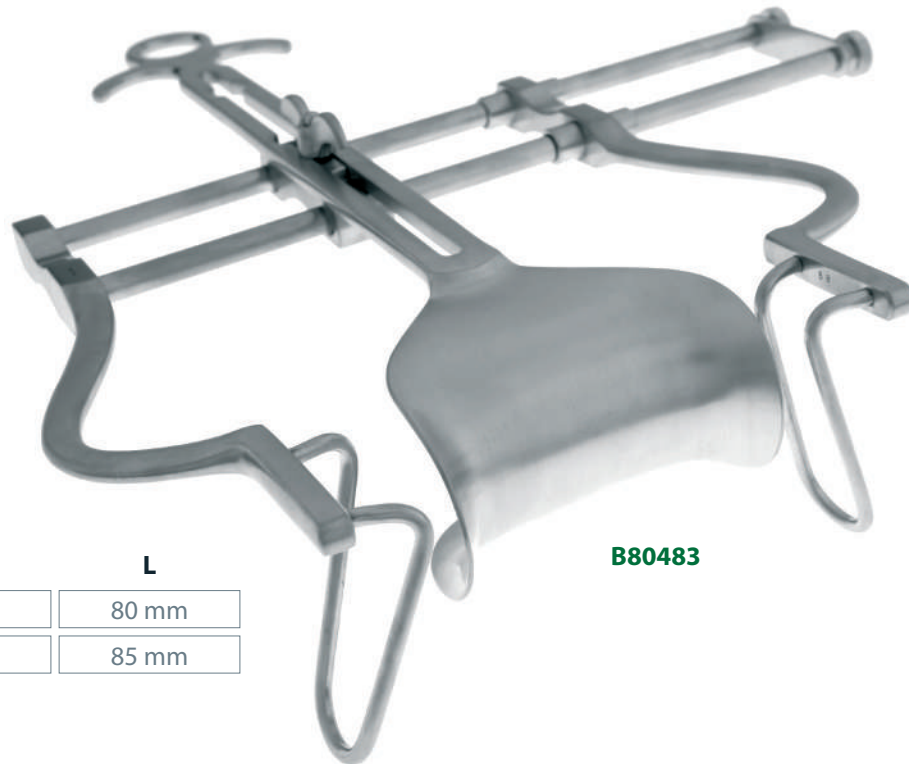
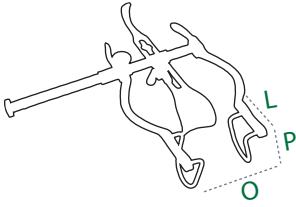

Valve médiane seule
Center blade only
Valva mediana sóla

	P	L
B804832	50 mm	80 mm
B804842	70 mm	85 mm

B80483

Complet
Complete
Completo

	O	P	L
 B80483	160 mm	65 mm	35 mm
B80484	250 mm	90 mm	35 mm

BALFOUR-BABY

Complet
Complete
Completo

	O	P	L
 B80482	90 mm	27 mm	25 mm

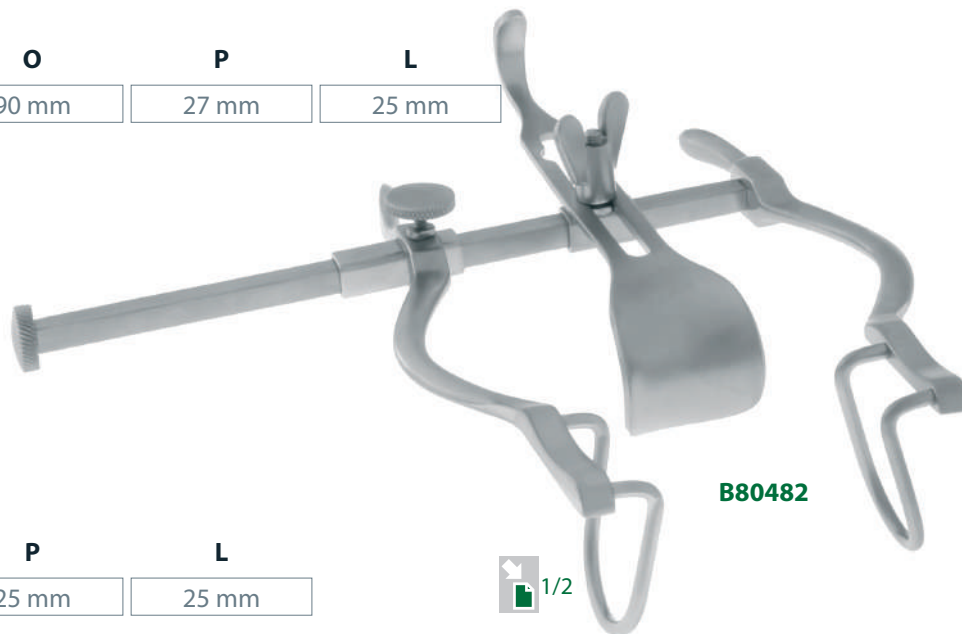

B80482

Valve médiane seule
Center blade only
Valva mediana sóla

	P	L
B804822	25 mm	25 mm



O : Ouverture - Blades opening - Abertura de las hojas
P : Profondeur - Depth - Profundidad
L : Largeur - Width - Anchura

BALFOUR



Complet
Complete
Completo



B804835

O

180 mm

P

70 mm

L

35 mm

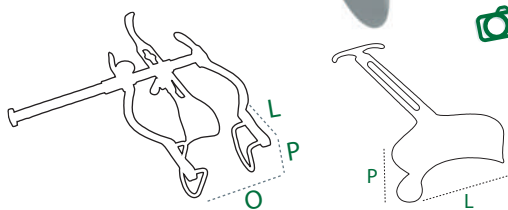

Valve médiane seule
Center blade only
Valva mediana sóla

P

45 mm

L

80 mm



Complet
Complete
Completo



B804850

O

200 mm

P

100 mm

L

35 mm

Valve médiane seule
Center blade only
Valva mediana sóla

P

100 mm

L

70 mm

LANDANGER

Écarteurs - Retractors - Separadores

BALFOUR (USA-MODEL)

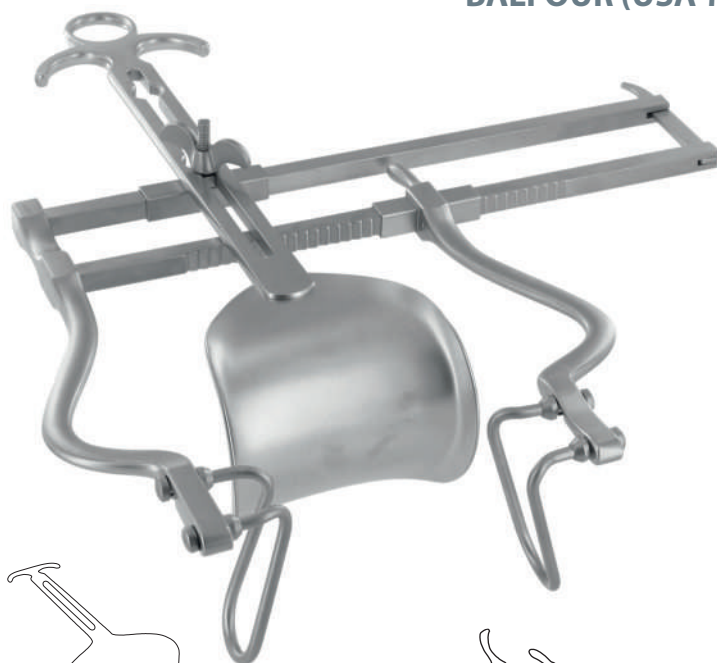

Écarteur seul
Retractor only
Separador sólo

O

B804854

180 mm

Valve médiane seule
Center blade only
Valva mediana sólo

P

L

B804856

45 mm

68 mm

B804857

68 mm

85 mm

Valves latérales seules (paire)
Lateral blades only (pair)
Valvas laterales sóloas (par)

P

L

B804858

60 mm

35 mm

B804859

80 mm

35 mm

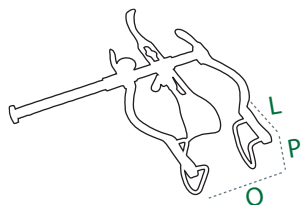
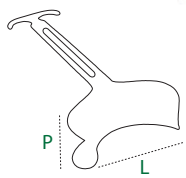

Complet
Complete
Completo

O

P

L



B804855

180 mm

60 mm

35 mm

ABADIE

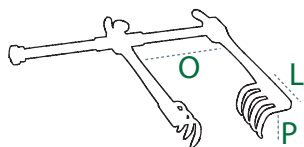
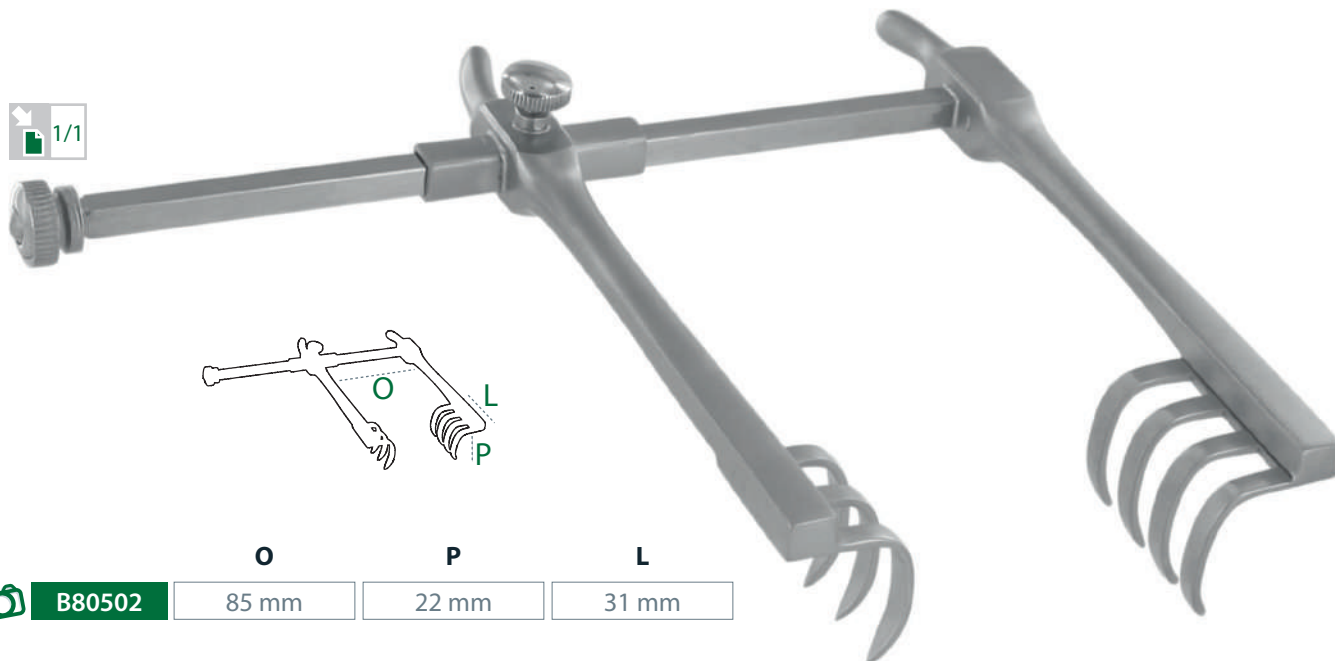

O

P

L



B80502

85 mm

22 mm

31 mm

O : Ouverture - Blades opening - Abertura de las hojas
P : Profondeur - Depth - Profundidad
L : Largeur - Width - Anchura



HRYNTSCHAK

Valve médiane seule
Center blade only
Valva mediana sóla

	P	L
B80507	90 mm	40 mm

Complet
Complete
Completo

	O	P	L
B80505	115 mm	80 mm	35 mm

Adultes
Adults
Adultos

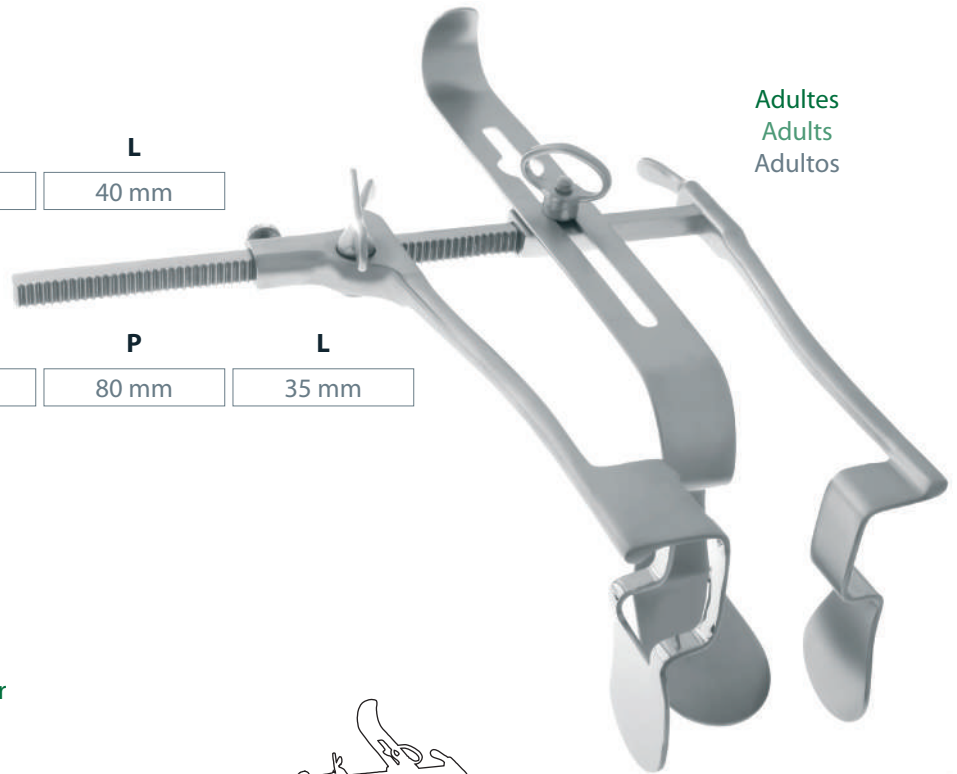

Curseur
Cursor
Cursor

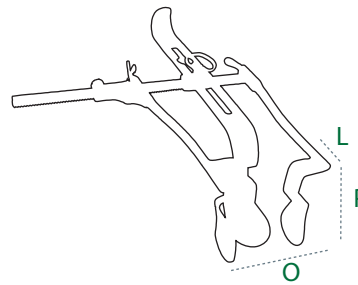

Enfants
Children
Niños

Valve médiane seule
Center blade only
Valva mediana sóla

	P	L
B80511	60 mm	25 mm

Complet
Complete
Completo

	O	P	L
B80509	85 mm	45 mm	18 mm

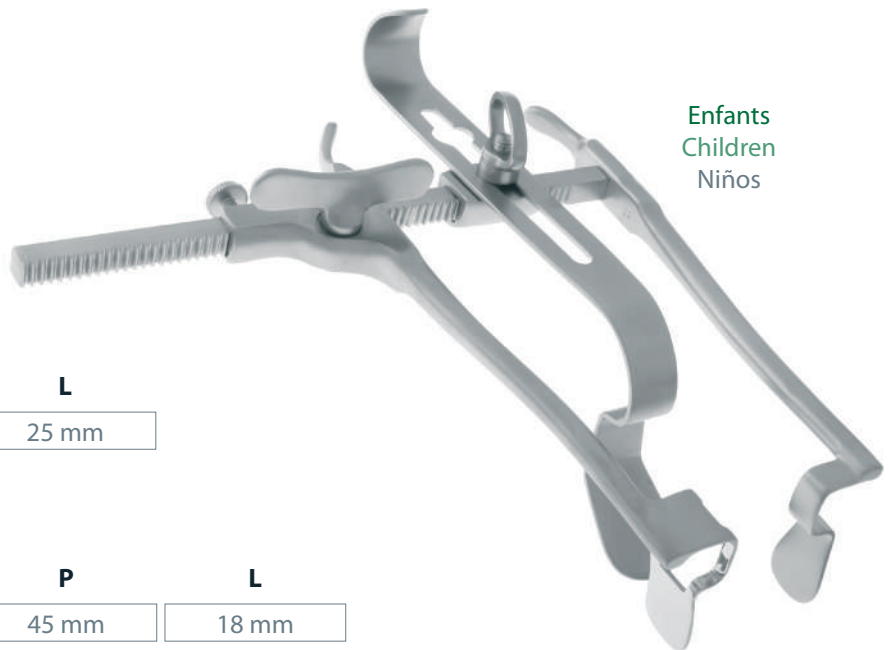

O : Ouverture - Blades opening - Abertura de las hojas
P : Profondeur - Depth - Profundidad
L : Largeur - Width - Anchura

MILLIN

Complet avec 5 valves
Complete with 5 blades
Completo con 5 valvas

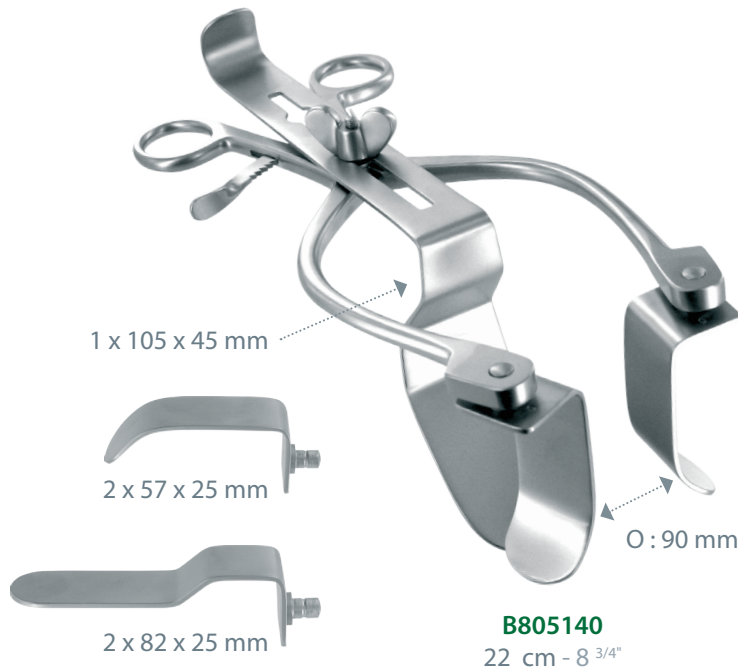

MILLIN



JUDD-MASSON

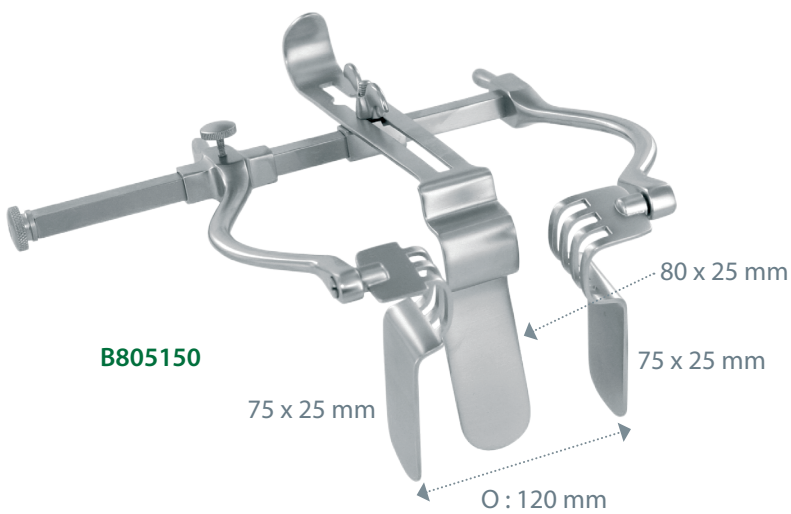

LEGUEU



O : Ouverture - Blades opening - Abertura de las hojas
P : Profondeur - Depth - Profundidad
L : Largeur - Width - Anchura

DARTIGUES (LAPAROSTAT)

29 cm - 11 1/2" **B80450**

32 cm - 12 1/2" **B80455** 

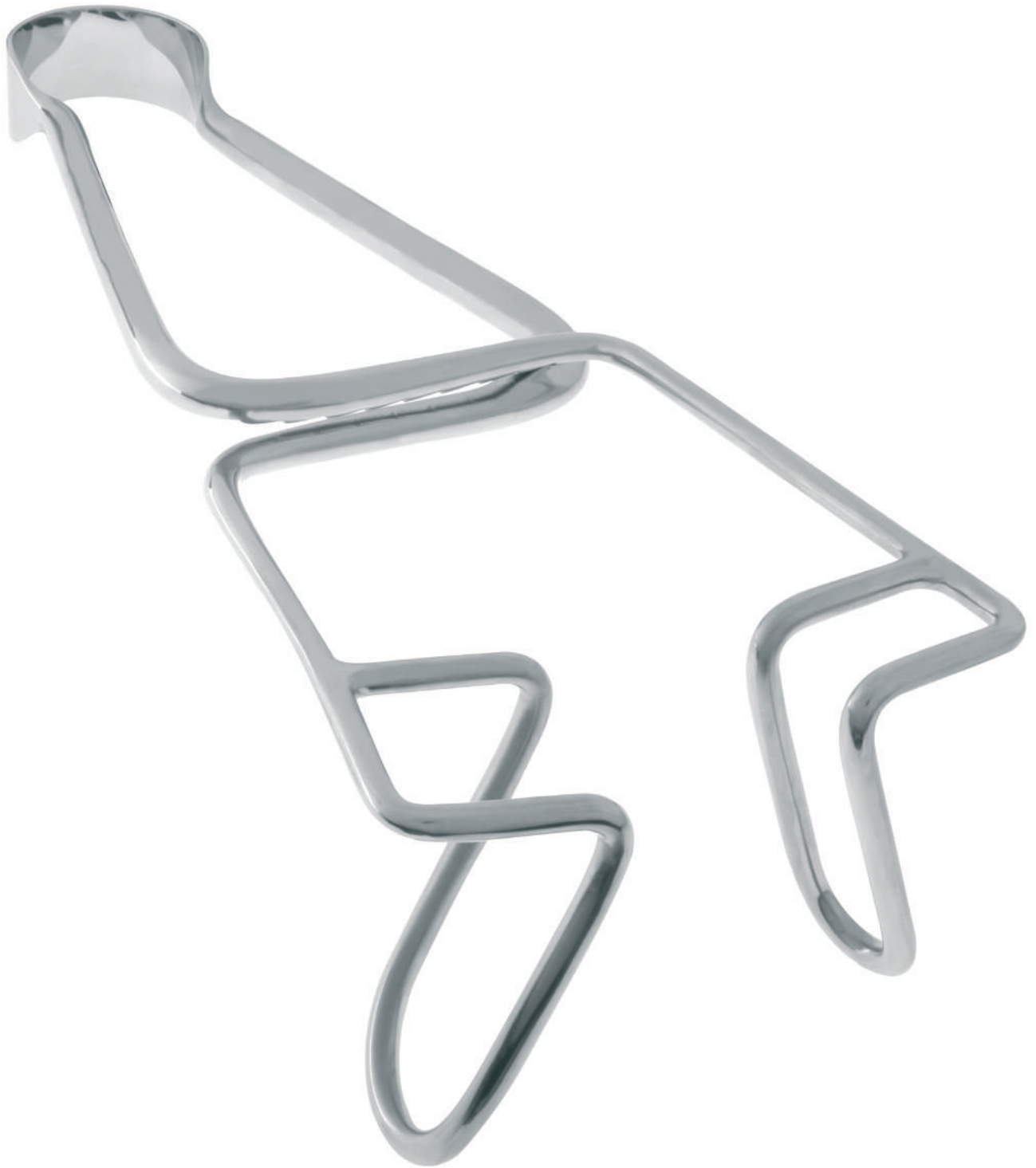

B80455
32 cm - 12 1/2"

FINOCHIETTO

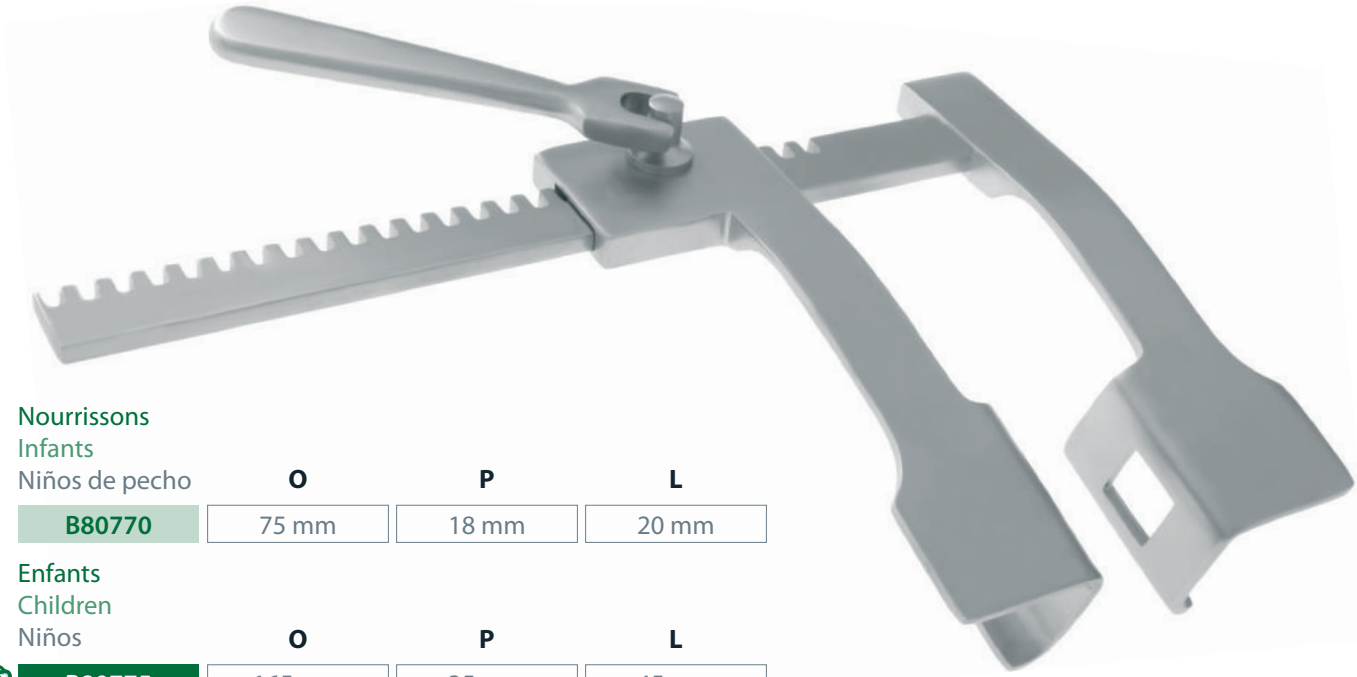

Nourrissons

Infants

Niños de pecho

	O	P	L
B80770	75 mm	18 mm	20 mm

Enfants

Children

Niños

	O	P	L
B80775	165 mm	35 mm	45 mm

Adultes

Adults

Adultos

	O	P	L
B80780	200 mm	45 mm	65 mm

B807860	200 mm	65 mm	65 mm
----------------	--------	-------	-------

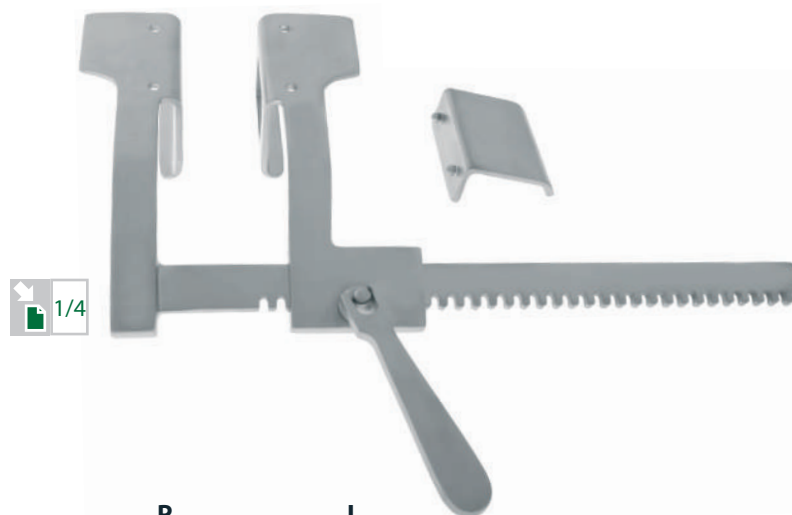
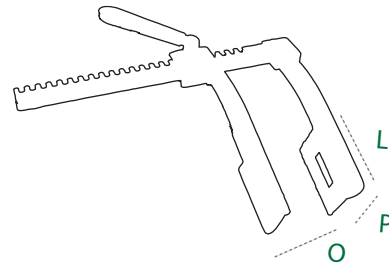

Complet avec valve supérieure

Complete with upper blade

Completo con válvula superior

	O	P	L
B80785	200 mm	45 mm	65 mm

O : Ouverture - Blades opening - Abertura de las hojas

P : Profondeur - Depth - Profundidad

L : Largeur - Width - Anchura

FINOCHIETTO

Complet avec 3 paires de valves
 Complete with 3 pairs of blades
 Completo con 3 pares de valvas

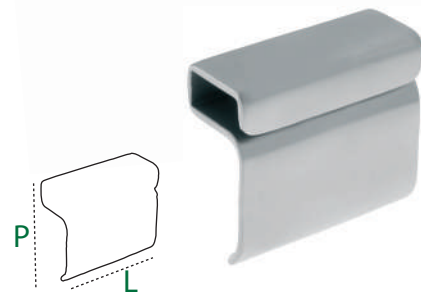
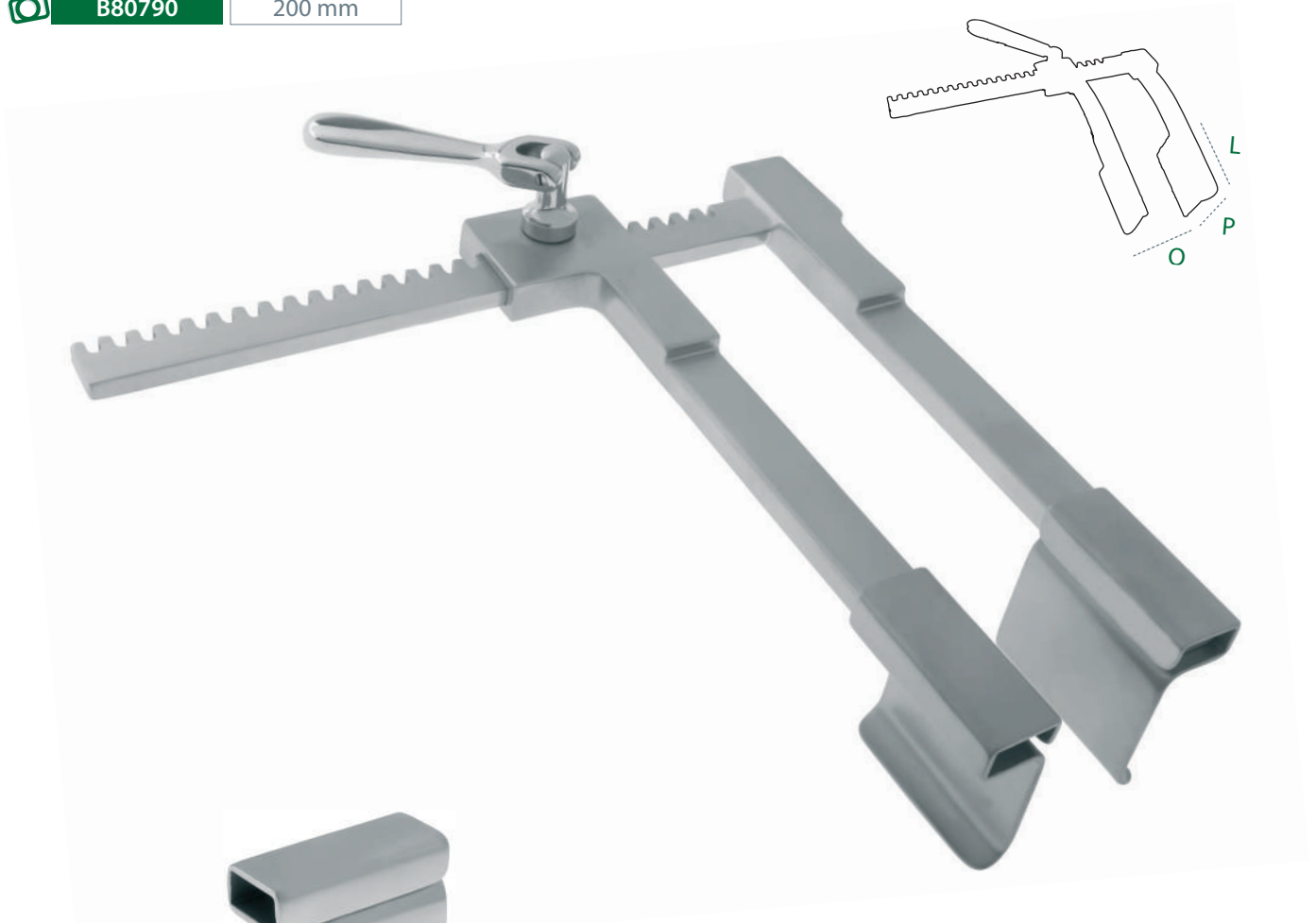

P	L
45 mm	40 mm
40 mm	60 mm
50 mm	60 mm

O : Ouverture - Blades opening - Abertura de las hojas
 P : Profondeur - Depth - Profundidad
 L : Largeur - Width - Anchura

FINOCHIETTO

Modèle Landanger complet avec 3 paires de valves
 Complete Landanger model with 3 pairs of blades
 Modelo Landanger completo con 3 pares de Valvas

 **B80792** 250 mm

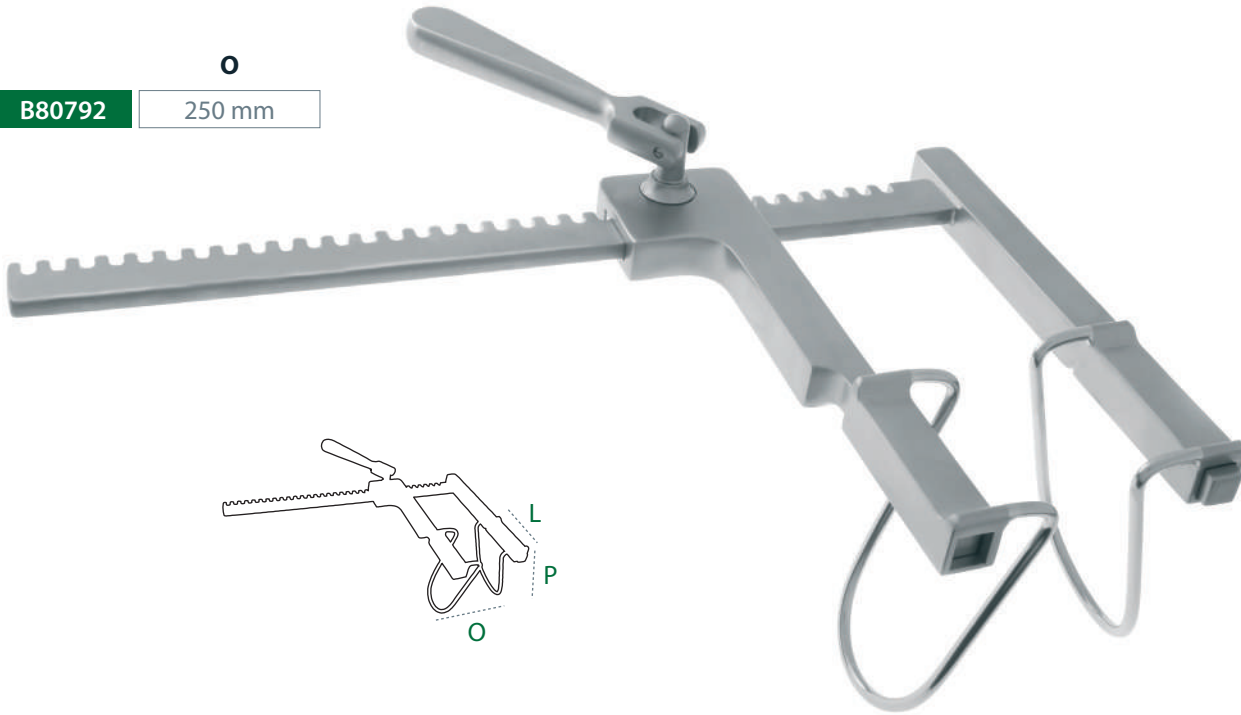

Valve genre Gosset
 Gosset blade
 Valva tipo Gosset

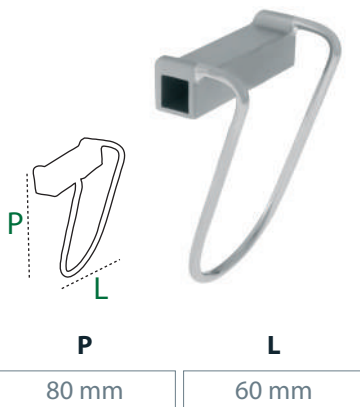

Valve thoracique
 Thoracic blade
 Valva toracica

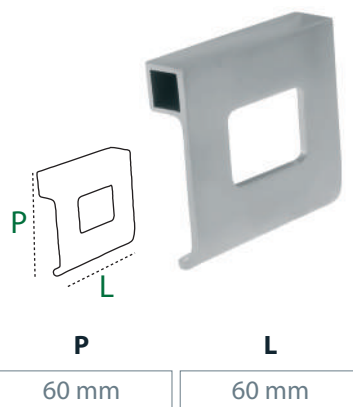

Valve abdominale
 Abdominal blade
 Valva abdominale

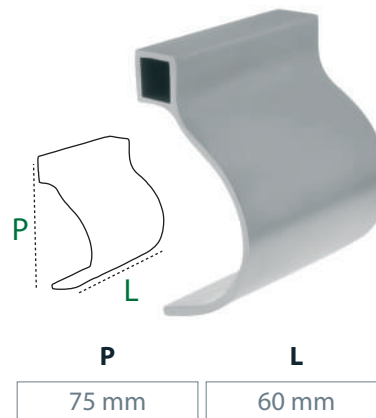

O : Ouverture - Blades opening - Abertura de las hojas
 P : Profondeur - Depth - Profundidad
 L : Largeur - Width - Anchura

 Aluminium
Aluminum
Aluminio

FINOCHIETTO

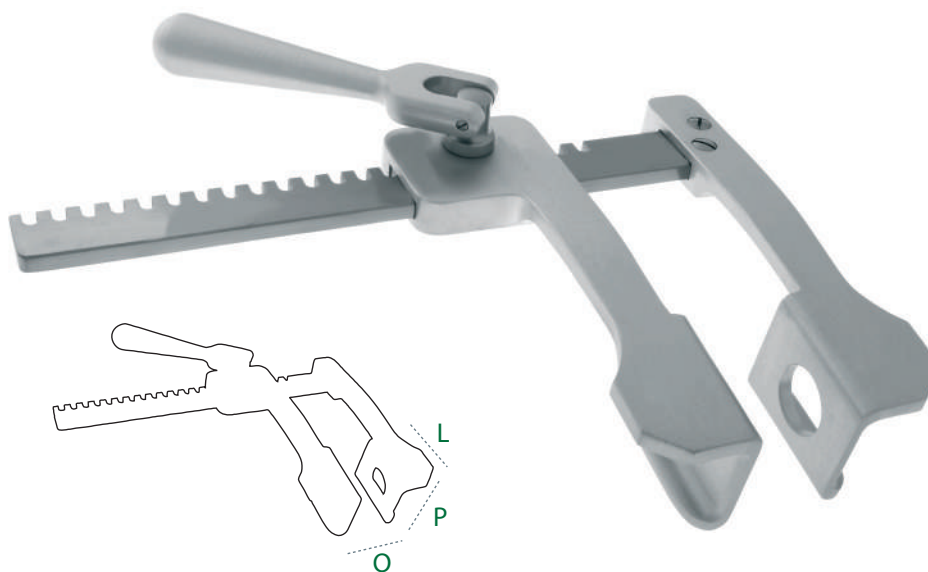

B80895

Nourrissons
Infants
Niños de pecho

	O	P	L
B80890	100 mm	31 mm	31 mm

BABY-HAIGHT

B808890	70 mm	12 mm	15 mm
B808895	70 mm	12 mm	15 mm

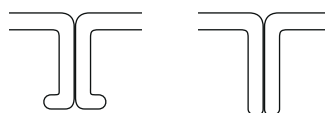

B808890

B808895

Enfants
Children
Niños

	O	P	L
B80895	150 mm	38 mm	44 mm

Adultes
Adults
Adultos

	O	P	L
B80900	180 mm	52 mm	62 mm

O : Ouverture - Blades opening - Abertura de las hojas
P : Profondeur - Depth - Profundidad
L : Largeur - Width - Anchura

DUBOST

Complet avec 2 paires de valves (35 et 45 mm)
 Complete with 2 pairs of blades (35 and 45 mm)
 Completo con 2 pares de valvas (35 y 45 mm)

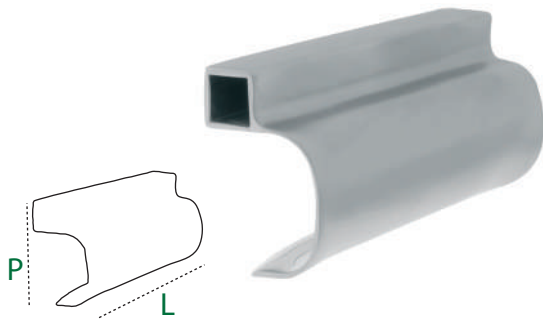
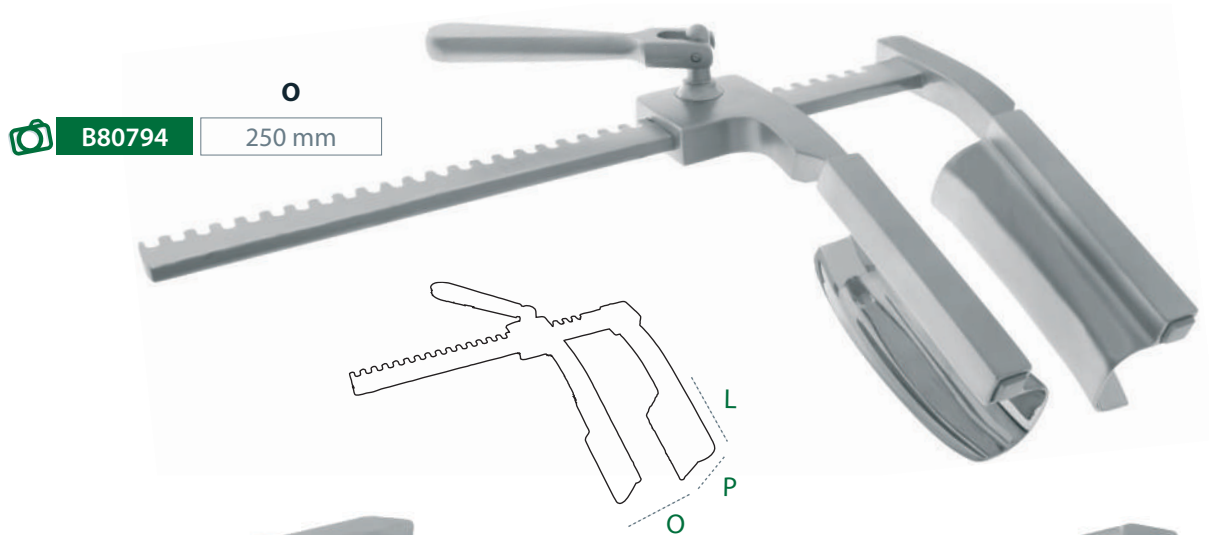

P 35 mm **L** 100 mm

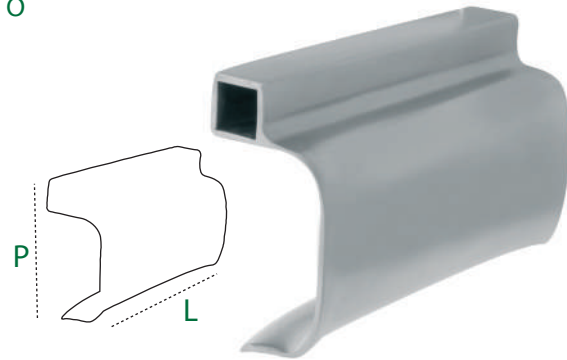

P 45 mm **L** 100 mm

Valves complémentaires seules (paire)
 Additional blades only (pair)
 Valvas adicional sólas (par)

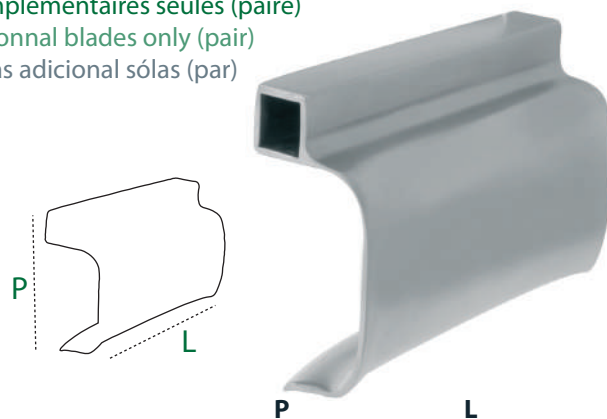

P 55 mm **L** 100 mm

O : Ouverture - Blades opening - Abertura de las hojas
 P : Profondeur - Depth - Profundidad
 L : Largeur - Width - Anchura

DUBOST NOGENT

Complet avec 3 paires de valves
 Complete with 3 pairs of blades
 Completo con 3 pares de valvas

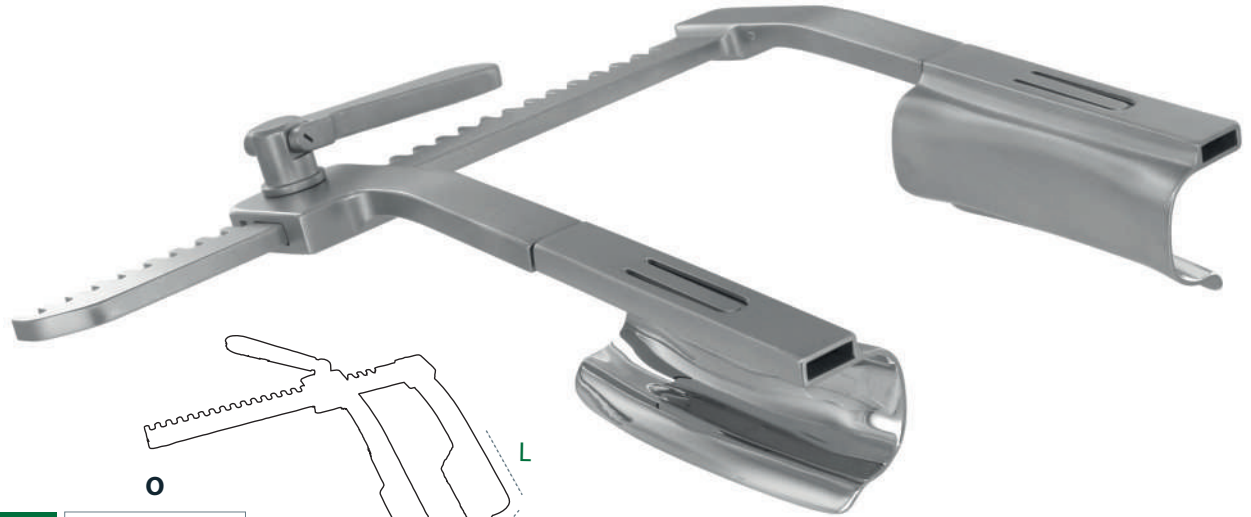

 **B807960** 280 mm

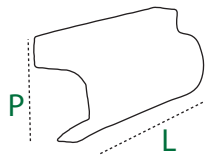
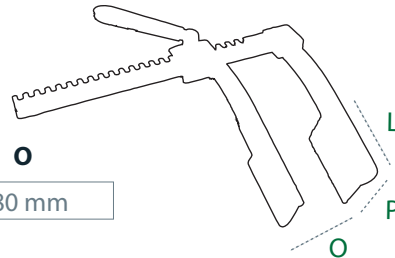

B807961 P 30 mm L 100 mm

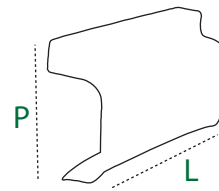

B807962 P 40 mm L 100 mm

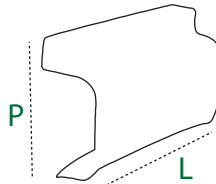

B807963 P 50 mm L 100 mm

O : Ouverture - Blades opening - Abertura de las hojas
 P : Profondeur - Depth - Profundidad
 L : Largeur - Width - Anchura

REVERSIBLE



	O	P	L	A
B807671	50 mm	10 mm	30 mm	65 mm
B807672	100 mm	16 mm	45 mm	75 mm
 B807673	100 mm	18 mm	55 mm	85 mm

STERNAL

 Aluminium
Aluminum
Aluminio



	O	P	L	A
B807675	65 mm	16 mm	30 mm	55 mm
B807676	72 mm	12 mm	45 mm	80 mm
 B807677	100 mm	15 mm	60 mm	125 mm

O : Ouverture - Blades opening - Abertura de las hojas

P : Profondeur - Depth - Profundidad

L : Largeur - Width - Anchura

A : Bras - Arm - Brazo

COOLEY

	O	P	L
 B807970	145 mm	21 mm	45 mm
B807971	190 mm	32 mm	50 mm

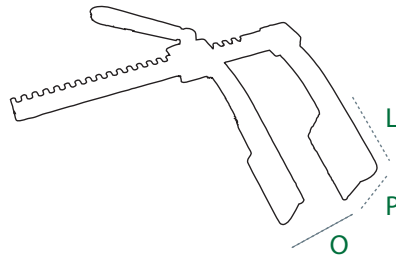
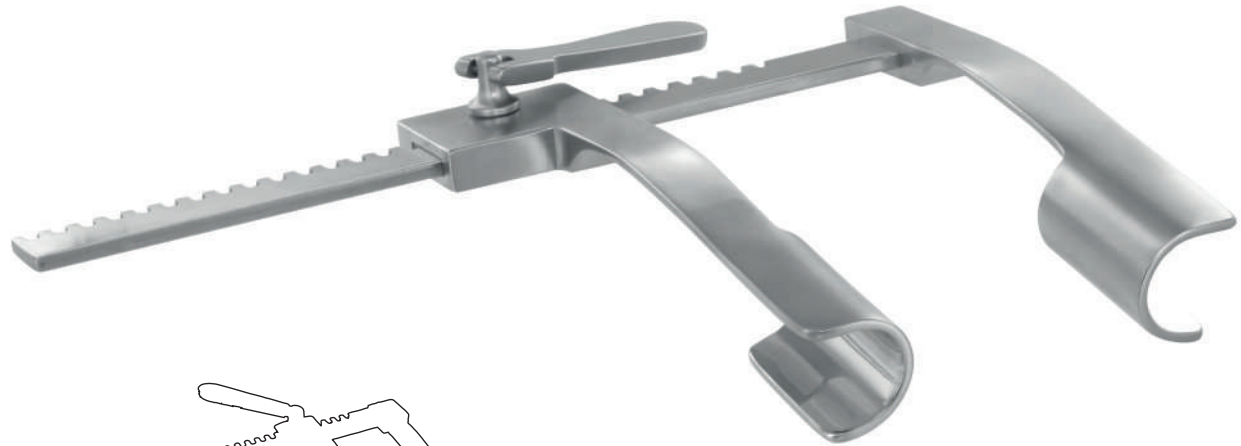

HAIGHT

	O	P	L
 B807975	95 mm	30 mm	30 mm



O : Ouverture - Blades opening - Abertura de las hojas
 P : Profondeur - Depth - Profundidad
 L : Largeur - Width - Anchura

DEBAKEY

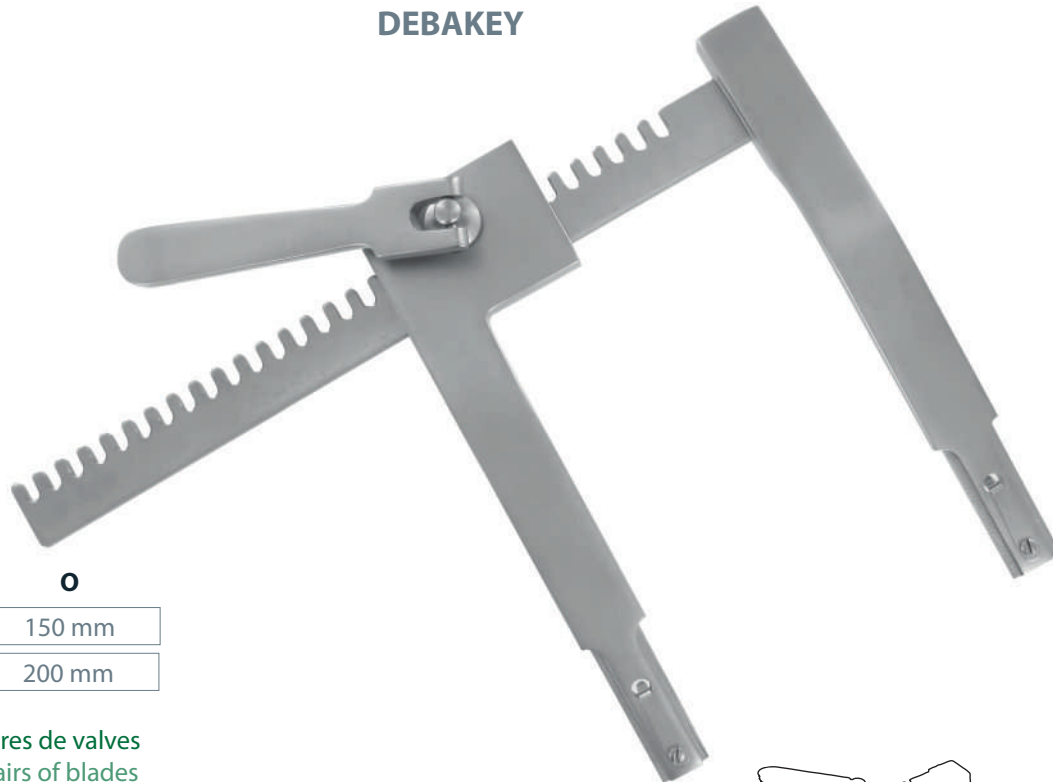

Écarteur seul
Retractor only
Separador solo

O

 B807985	150 mm
B807986	200 mm

Complet avec 3 paires de valves
Complete with 3 pairs of blades
Completo con 3 pares de valvas

B807980	150 mm	B807985 + B807990 + B807991 + B807992
B807981	200 mm	B807986 + B807993 + B807994 + B807995

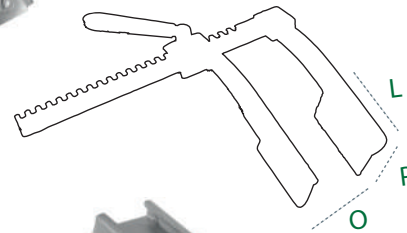

Pour B807985
For B807985
Para B807985



B807990
30 x 30 mm



B807991
40 x 40 mm



B807992
50 x 50 mm

Valves latérales (paire)
Lateral blades (pair)
Valvas laterales (par)

Pour B807986
For B807986
Para B807986



B807993
60 x 60 mm



B807994
50 x 80 mm



B807995
40 x 100 mm



B807996
80 x 60 mm



B807997
50 x 66 mm

O : Ouverture - Blades opening - Abertura de las hojas
P : Profondeur - Depth - Profundidad
L : Largeur - Width - Anchura

STRUCK

Écarteur seul
Retractor only
Separador sólo

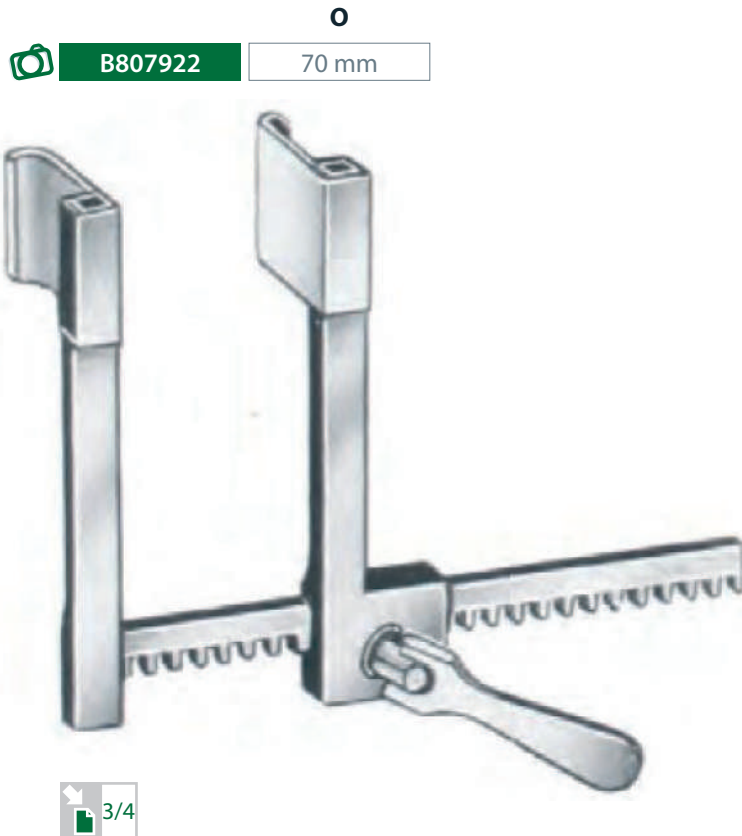

Valves latérales (paire)
Lateral blades (pair)
Valvas laterales (par)



P x L

B807923

10 x 10 mm



B807924

10 x 15 mm

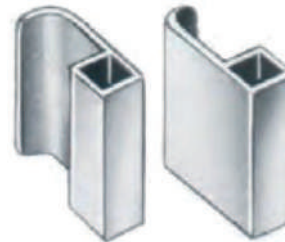

B807925

10 x 20 mm

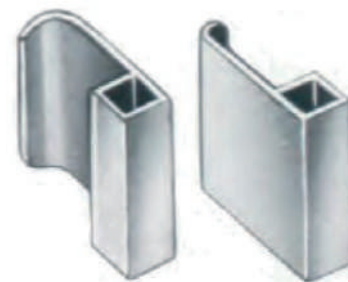

B807926

15 x 20 mm

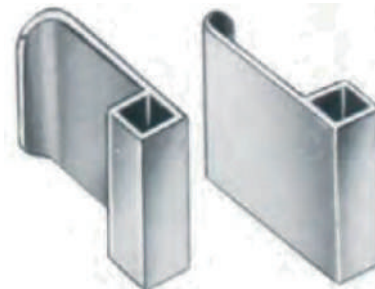

B807927

20 x 20 mm

O : Ouverture - Blades opening - Abertura de las hojas
P : Profondeur - Depth - Profundidad
L : Largeur - Width - Anchura

MERCEDES

Écarteur seul
Retractor only
Separador sólo

O

B807681 280 mm

Complet avec 2 paires de valves
Complete with 2 pairs of blades
Completo con 2 pares de valvas

O

 **B807680** 280 mm

Valves latérales (paire)
Lateral blades (pair)
Valvas laterales (par)

P

L

B807682 75 mm 80 mm

B807683 48 mm 65 mm

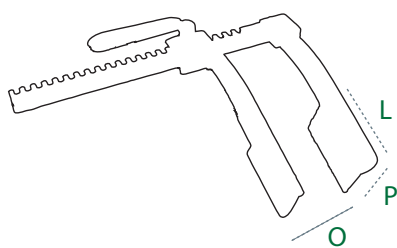

MORSE-FAVALORO



O

P

L

B807685 155 mm 12 mm 20 mm

 **B807686** 200 mm 40 mm 20 mm

O : Ouverture - Blades opening - Abertura de las hojas

P : Profondeur - Depth - Profundidad

L : Largeur - Width - Anchura

RACHIS NOGENT

Complet avec 6 paires de valves
 Complete with 6 pairs of blades
 Completo con 6 pares de valvas

O

	B809020	180 mm
-----------------------------------------------------------------------------------	----------------	--------



Valves seules (2 paires)
 Blades only (2 pairs)
 Valvas sólo (2 pares)

P

L

	B809021	40 mm	12 mm
	B809022	50 mm	12 mm
	B809023	65 mm	12 mm

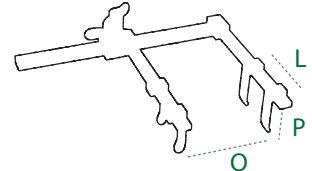

CHANDLER

Complet avec 3 paires de valves
 Complete with 3 pairs of blades
 Completo con 3 pares de valvas



O

	B809030	100 mm
-------------------------------------------------------------------------------------	----------------	--------

Valves seules (paires)
 Blades only (pairs)
 Valvas sólo (pares)

P

L

	B809031	40 mm	15 mm
	B809032	55 mm	24 mm
	B809033	65 mm	24 mm
	B809034	85 mm	24 mm
	B809035	100 mm	24 mm



O : Ouverture - Blades opening - Abertura de las hojas
 P : Profondeur - Depth - Profundidad
 L : Largeur - Width - Anchura

DRYSSEN

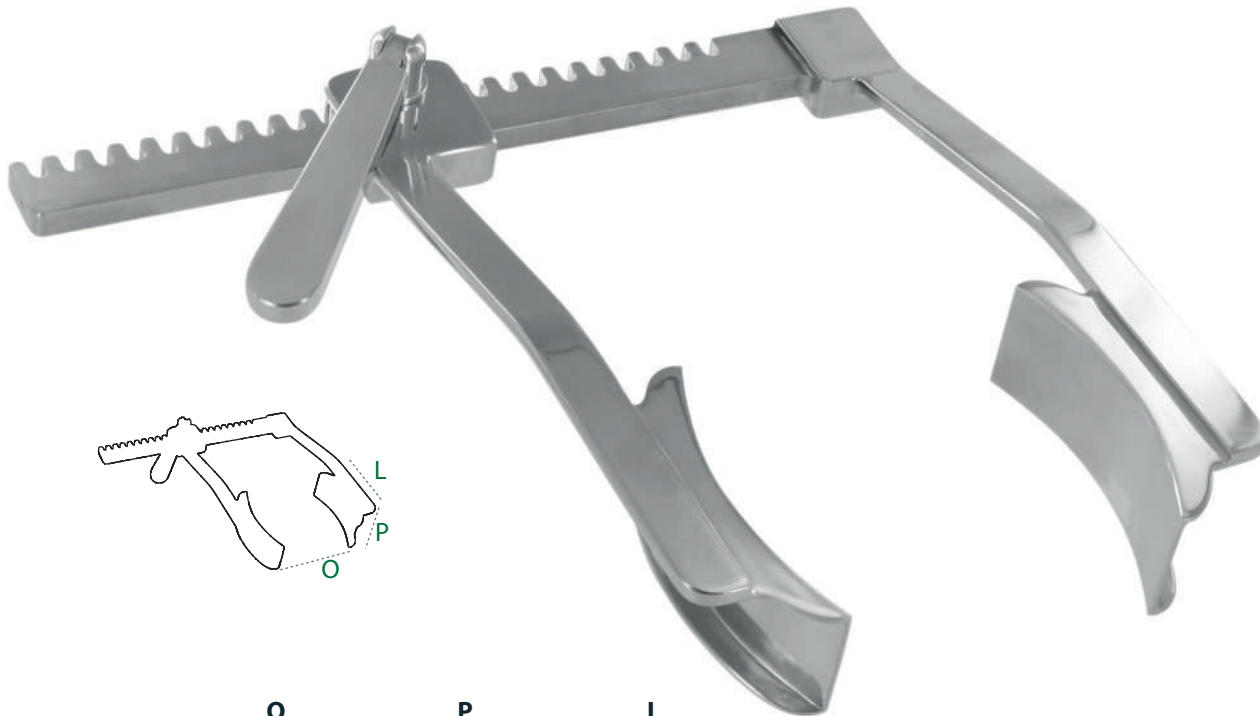

 B807690	O 185 mm	P 34 mm	L 90 mm
--------------------------------------------------------------------------------------------------	--------------------	-------------------	-------------------

FINOCHIETTO-BURFORD

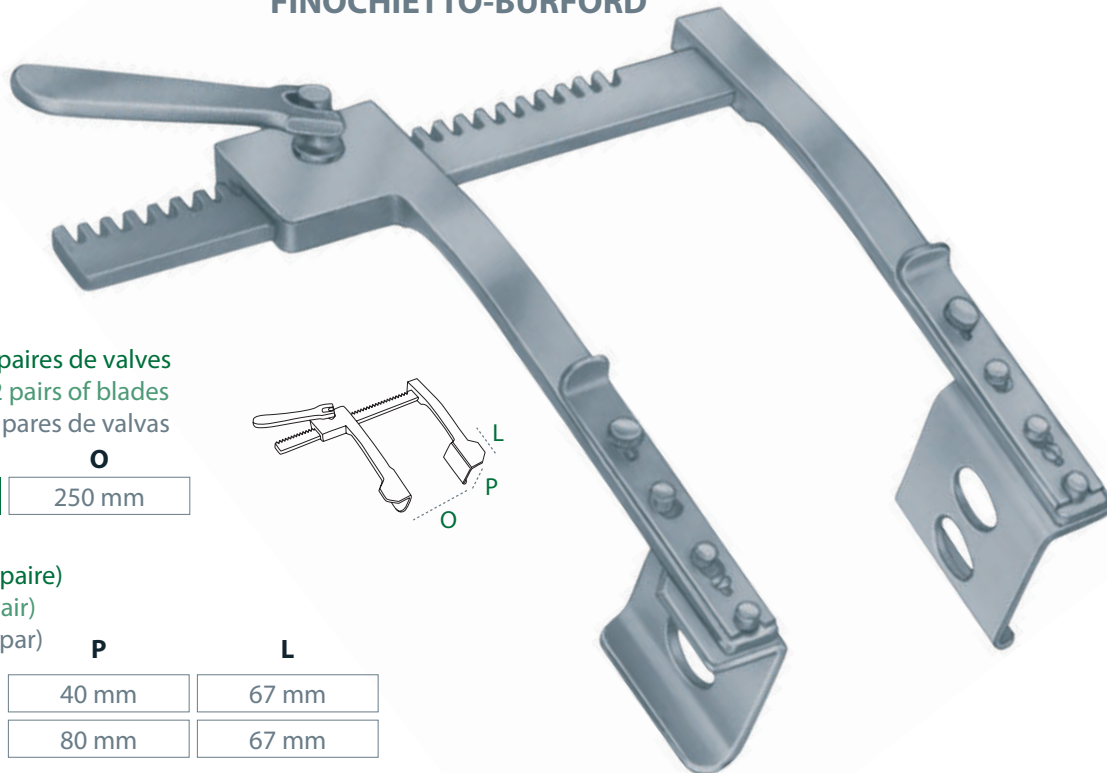

Complet avec 2 paires de valves
Complete with 2 pairs of blades
Completo con 2 pares de valvas

 B807692	O 250 mm
---------------------------------------------------------------------------------------------------	--------------------

Valves latérales (paire)
Lateral blades (pair)
Valvas laterales (par)

	P	L
B807693	40 mm	67 mm
B807694	80 mm	67 mm

O : Ouverture - Blades opening - Abertura de las hojas
P : Profondeur - Depth - Profundidad
L : Largeur - Width - Anchura

HERTZLER

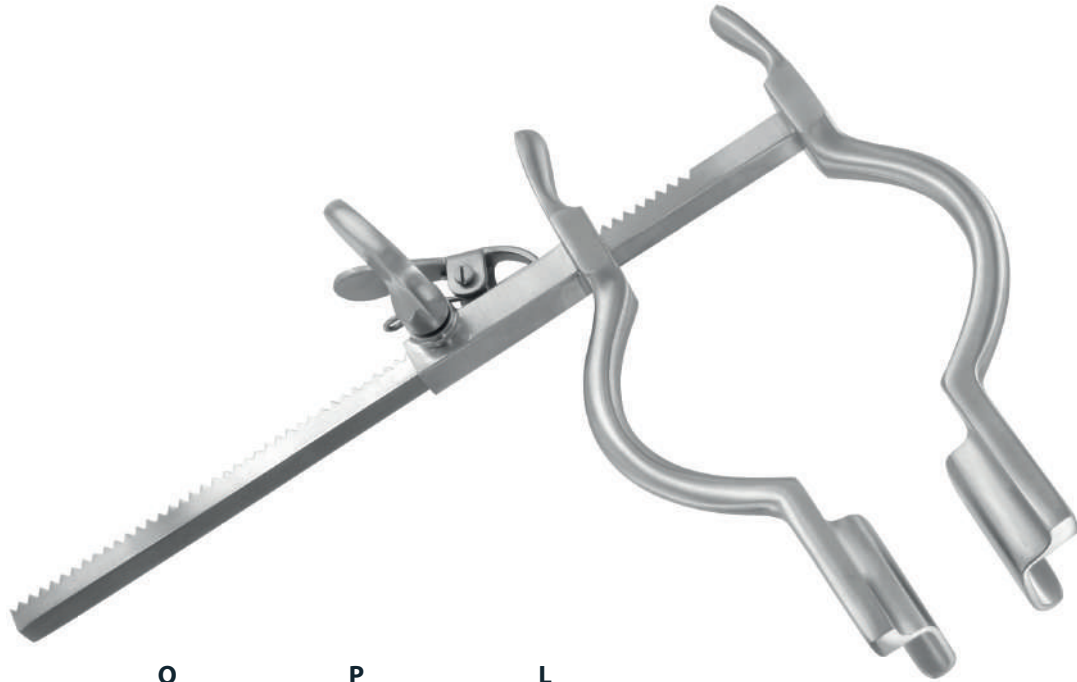

	O	P	L
 B807955	130 mm	21 mm	25 mm

TUFFIER

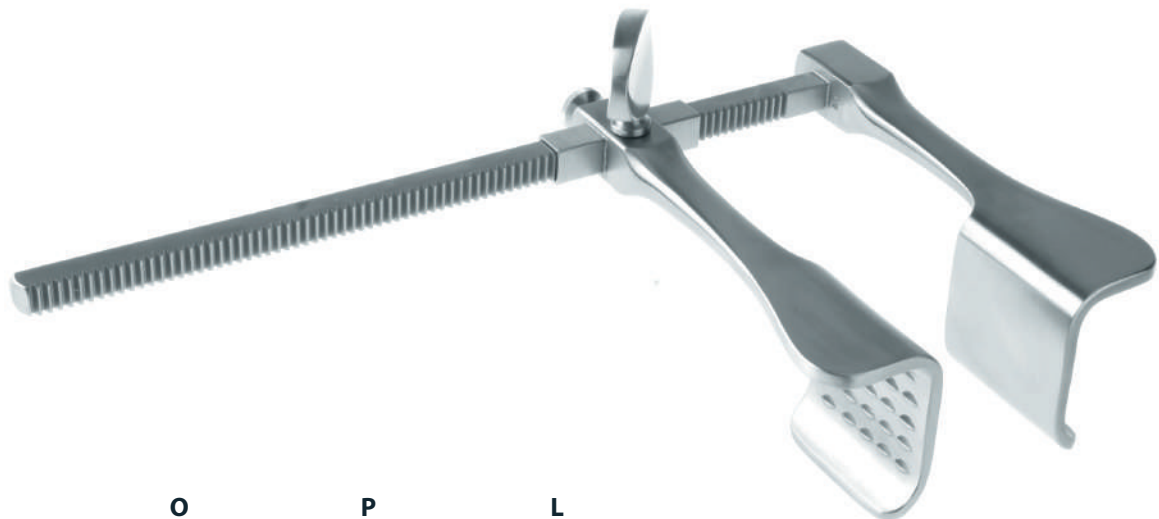
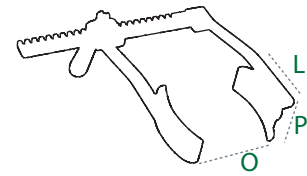

	O	P	L
 B80795	165 mm	42 mm	50 mm

O : Ouverture - Blades opening - Abertura de las hojas
 P : Profondeur - Depth - Profundidad
 L : Largeur - Width - Anchura

BAILEY-BABY

Rapprocheur de cotes
Rib contractor
Contractor de costillas



B808010
14 cm - 5 1/2"

BAILEY



B80800
20 cm - 8"

SELLORS

Valves pivotantes à 180°
Swivel valves to 180°
Valvas oscilantes hasta 180°



B808020
20 cm - 8"

MAURER

Mors mobile
Mobile jaws
Bocados móviles



J521850
19 cm - 7 1/2"

MATHEY



J521860
18 cm - 7"

TESSIER

Pince à expansion
Expansion forceps
Pinza de expansión



J521870
18 cm - 7"

FINSEN

	Pointu Sharp Agudo	Mousse Blunt Romo	Griffes Teeth Dientes
5 cm - 2" 	B80295	B802951	2 x 3
7 cm - 2 3/4"	B80300	B803001	3 x 4



B80295
5 cm - 2"



B803005
7 cm - 2 3/4"

ALM

	Pointu Sharp Agudo	Mousse Blunt Romo
7 cm - 2 3/4" 	B802912	B802913
10 cm - 4"	B802914	B802915



B802912
7 cm - 2 3/4"

HEISS (HOLZEIMER)

	Mousse Blunt Romo	Pointu Sharp Agudo
	B80320	B803205



B80320
10 cm - 4"

JANSEN-DEEP

Pointu	Mousse
Sharp	Blunt
Agudo	Romo

11,5 cm - 4^{1/2}"

B80290

B802901



JANSEN

Pointu	Mousse
Sharp	Blunt
Agudo	Romo

8 cm - 3^{1/4}"



B802905

B802910



B802901

11,5 cm - 4^{1/2}"



B802905

8 cm - 3^{1/4}"

PLESTER



B805241
11 cm - 4 1/2"





B805240
11 cm - 4 1/2"



B805246
13 cm - 5"

	Pointu	Mousse	
	Sharp	Blunt	
	Agudo	Romo	
13 cm - 5"	B805245	B805246 	

WEITLANER

	Pointu Sharp Agudo	Semi-pointu Semi-sharp Semi-agudo	Mousse Blunt Romo
11,5 cm - 4 ¹ / ₂ "	 B80525	B805252	B805251
13 cm - 5"	B80530	B805302	 B805301
17 cm - 6 ³ / ₄ "	B80535	 B805352	B805351



WEITLANER

TRAVERS

Pointu
Sharp
Agudo

Mousse
Blunt
Romo



20 cm - 8" 	B80537	B805371
25 cm - 9 ³ / ₄ "	B805360	B805361
25 cm - 9 ³ / ₄ "	B805390	B805391



B805360
25 cm - 9³/₄"



B805390
25 cm - 9³/₄"



B80537
20 cm - 8"



B805415
21,5 cm - 8¹/₂"

Mousse
Blunt
Romo

25 mm

HENLEY



Complet avec 1 valve médiane 16 x 25 mm
 Complete with 1 center blade 16 x 25 mm
 Completo con 1 valva mediana 16 x 25 mm



Avec valves latérales démontables (Paire)
 With removable side blades (Pair)
 Con valvas laterales extraíbles (Par)

4 griffes mousses
 4 blunt teeth
 4 dientes romos

4 griffes pointues
 4 sharp teeth
 4 dientes agudos

	P	L	
			
B815450	10 mm	30 mm	B815440
B815451	16 mm	45 mm	B815441
B815452	18 mm	55 mm	B815442

Valve médiane seule
 Center blade only
 Valva mediana sola

	P	L
B815430	19 mm	18 mm
B815431	25 mm	18 mm
B815432	32 mm	18 mm

Valve médiane seule
 Center blade only
 Valva mediana sola

	P	L
B805421	19 mm	16 mm
B805422	25 mm	16 mm
B805423	32 mm	16 mm

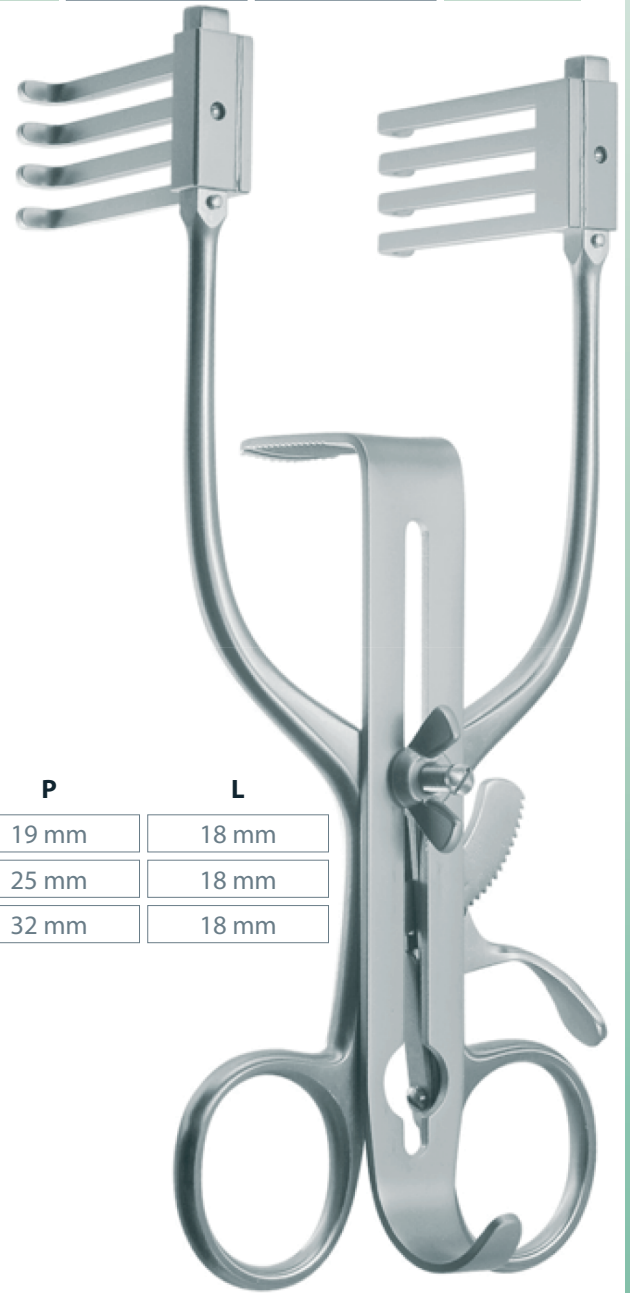

B815420
17,5 cm - 7"

P : Profondeur - Depth - Profundidad
 L : Largeur - Width - Anchura

MAC KEE



J52180
28 cm - 11"

NORFOLK-NORWICH



B808655
22 cm - 8 ³/₄"

WEITLANER (MOLLISON)

Courbe (dos d'âne) - Curved (back ass) - Curva (a bombado)

Pointu
Sharp
Agudo

Dents
Teeth
Dientes



16 cm - 6 1/4"

B80538

4 x 4



WEITLANER-WULLSTEIN

Pointu
Sharp
Agudo

Mousse
Blunt
Romo

Dents
Teeth
Dientes



13 cm - 5"

B805395

B805396

3 x 3

16 cm - 6 1/4"

B80540

B805401

3 x 4

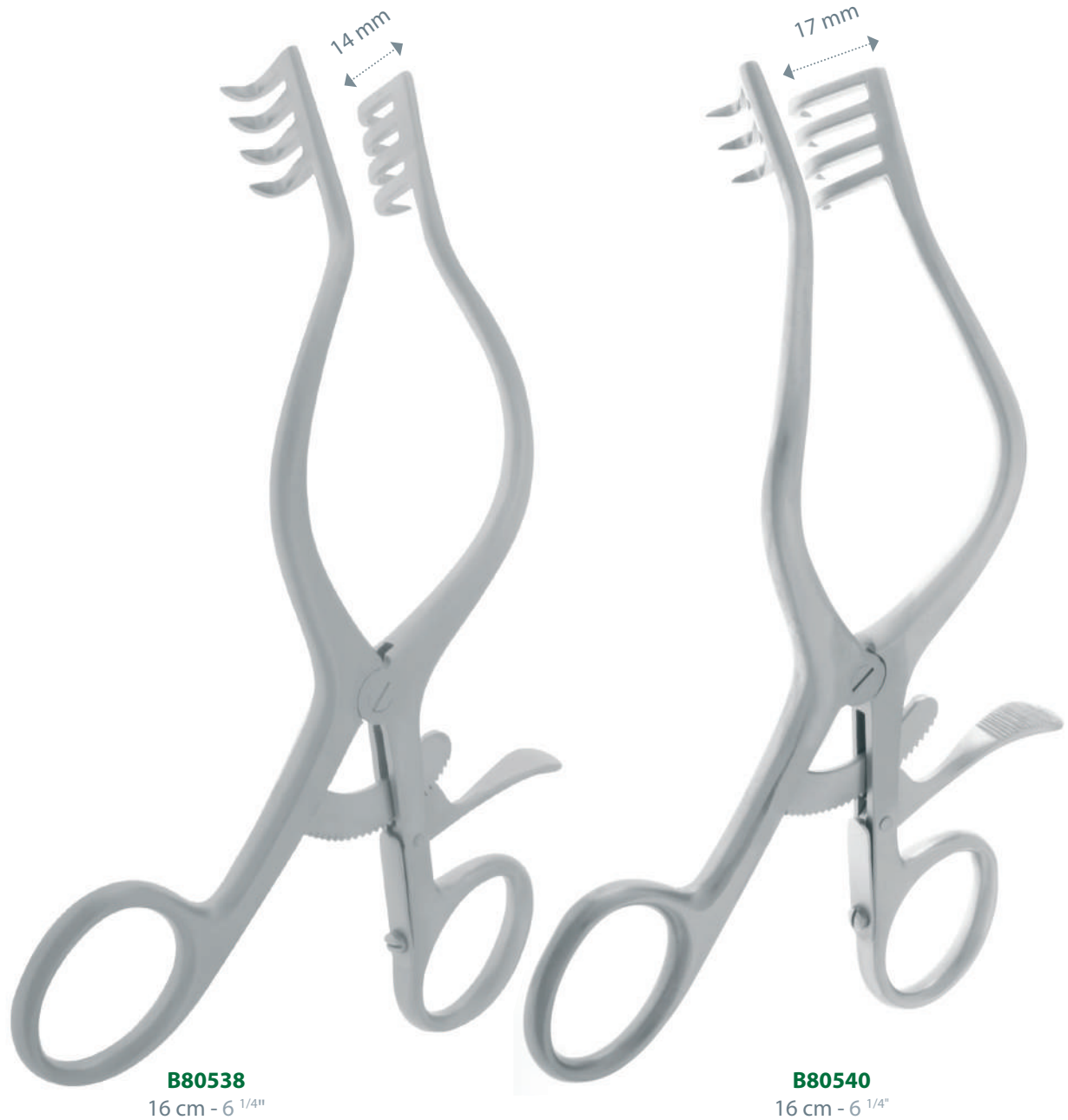

B80538

16 cm - 6 1/4"

B80540

16 cm - 6 1/4"

WEITLANER-NEURO

ANDERSON-ADSON

Courbe (dos d'âne) - Curved (back ass) - Curva (a bombado)

Pointu
Sharp
Agudo

Mousse
Blunt
Romo



20 cm - 8"

B805412

B805413



Pointu
Sharp
Agudo

20 mm



B805410
20 cm - 8"





20 mm

B805413
20 cm - 8"

BECKMANN CONE

	Pointu Sharp Agudo	Mousse Blunt Romo	Dents Teeth Dientes	
			P	
14 cm - 5 ¹ / ₂ "	B805425	B80543	14 mm	3 x 4
17 cm - 6 ³ / ₄ "	B805445	B80545	14 mm	3 x 4
21 cm - 8 ¹ / ₄ "	B805495	B80550	16 mm	3 x 4
26 cm - 10 ¹ / ₄ "	B805530	B805535	25 mm	3 x 4

BECKMANN

	Mousse Blunt Romo	Dents Teeth Dientes	
		P	
14 cm - 5 ¹ / ₂ "	B80544	8 mm	4 x 4
17 cm - 6 ³ / ₄ "	B80546	10 mm	4 x 4
21 cm - 8 ¹ / ₄ " 	B80551	14 mm	4 x 4
21 cm - 8 ¹ / ₄ "	B80548	30 mm	4 x 4



B80550
21 cm - 8¹/₄"



B80551
21 cm - 8¹/₄"

P : Profondeur - Depth - Profundidad

BECKMANN-GOITER

BECKMANN

BECKMANN-STILLE

Mousse
Blunt
Romo

Dents
Teeth
Dientes

Pointu
Sharp
Agudo

Mousse
Blunt
Romo



P



B80556

20 mm

4 x 4

B80561

30 mm

4 x 4

B80566

50 mm

5 x 5



B805550

B805551

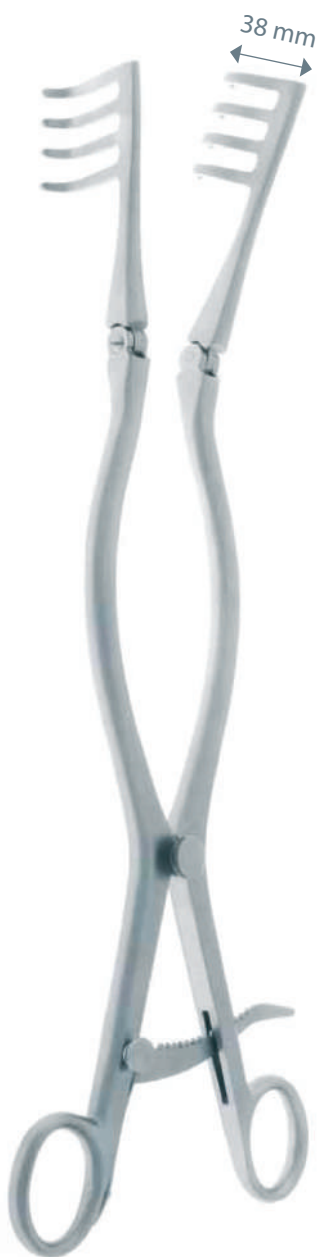

B805420
31 cm - 12^{1/4}"



B80556
30 cm - 11^{3/4}"

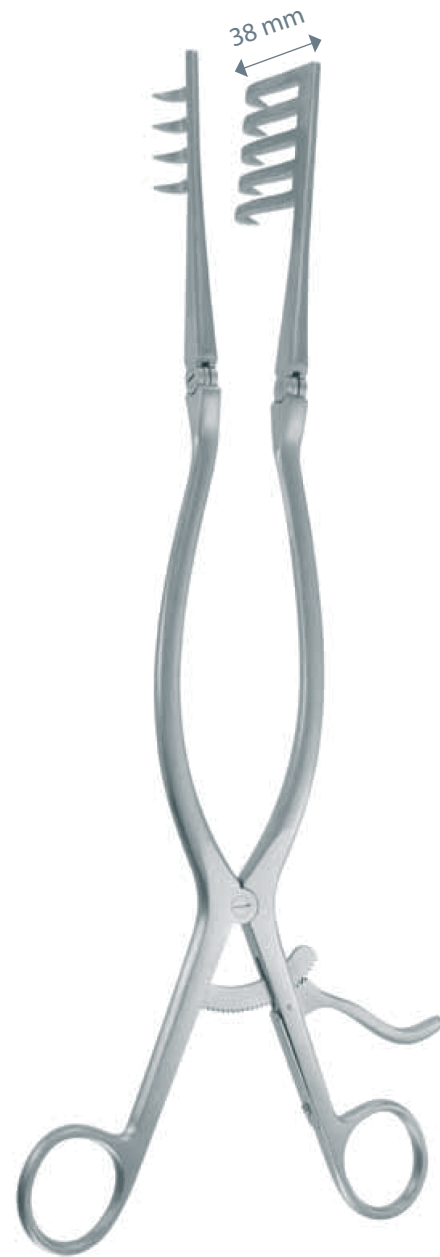

B805550
32,5 cm - 13"

P : Profondeur - Depth - Profundidad

BECKMANN

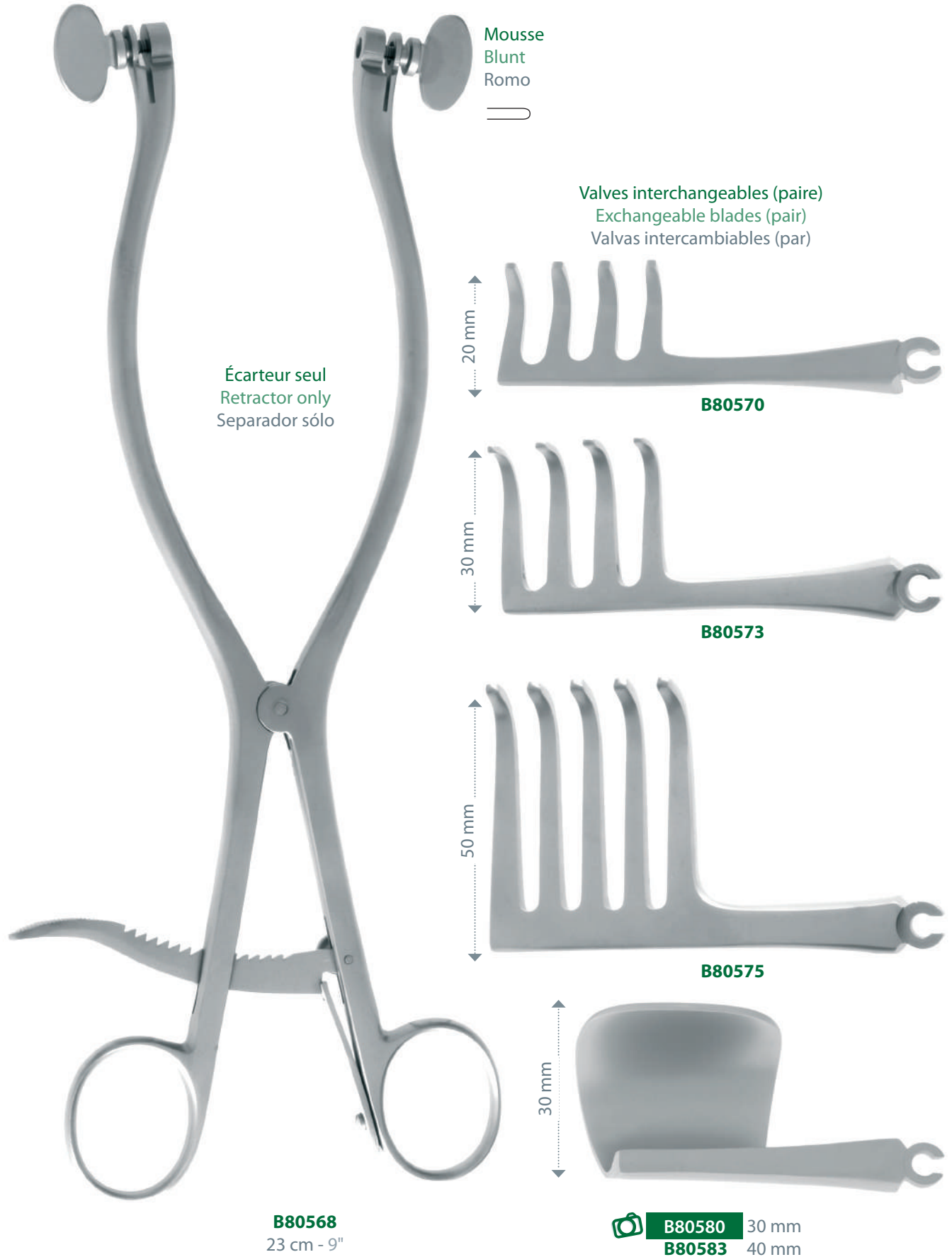

Mousse
Blunt
Romo



Valves interchangeables (paire)
Exchangeable blades (pair)
Valvas intercambiables (par)

Écarteur seul
Retractor only
Separador sólo

20 mm

B80570

30 mm

B80573

50 mm

B80575

30 mm



B80580

30 mm

B80583

40 mm

B80568
23 cm - 9"

DECOULX



B80588
33 cm - 13"

Griffes rondes
Round teeth
Dientes redondos

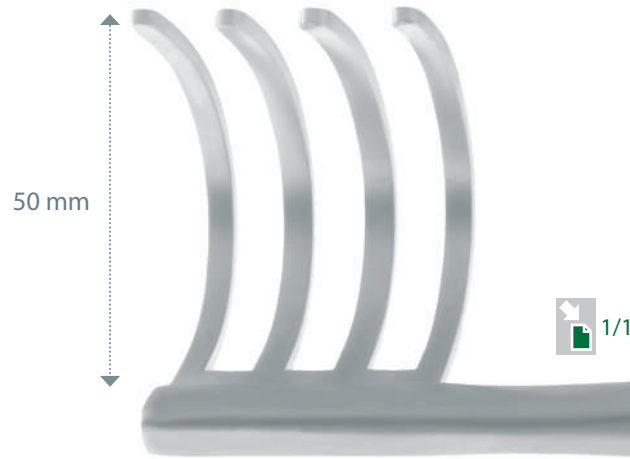

B80586

Griffes carrées
Square teeth
Dientes cuadradas



B80588

BECKMANN-EATON

Pointu
Sharp
Agudo



Mousse
Blunt
Romo



B808580

B808581

ADSON

Mousse
Blunt
Romo



HARVEY JACKSON

Pointu
Sharp
Agudo



B808580
33 cm - 13"





B808590
31 cm - 12¹/₄"



B808595
28 cm - 11"

BECKMANN-ADSON

	Pointu Sharp Agudo	Mousse Blunt Romo	
			
25 mm 	B808680	B808681	4x5
37 mm	B808663	B808664	4x5
44 mm	B808672	B808673	4x5

	Pointu Sharp Agudo	Semi-pointu Semi-sharp Semi-agudo	Mousse Blunt Romo
			
22 mm	B808660	B808662	B808661
			



ADSON

	Pointu Sharp Agudo	Mousse Blunt Romo	P
4x4 - 19 cm	B808690	B808691	23 mm
3x4 - 27 cm	B808692	B808693	23 mm
3x4 - 27 cm	B808694	B808695	30 mm
3x4 - 27 cm	B808696	B808697	40 mm



B808694
27 cm - 10 1/2"

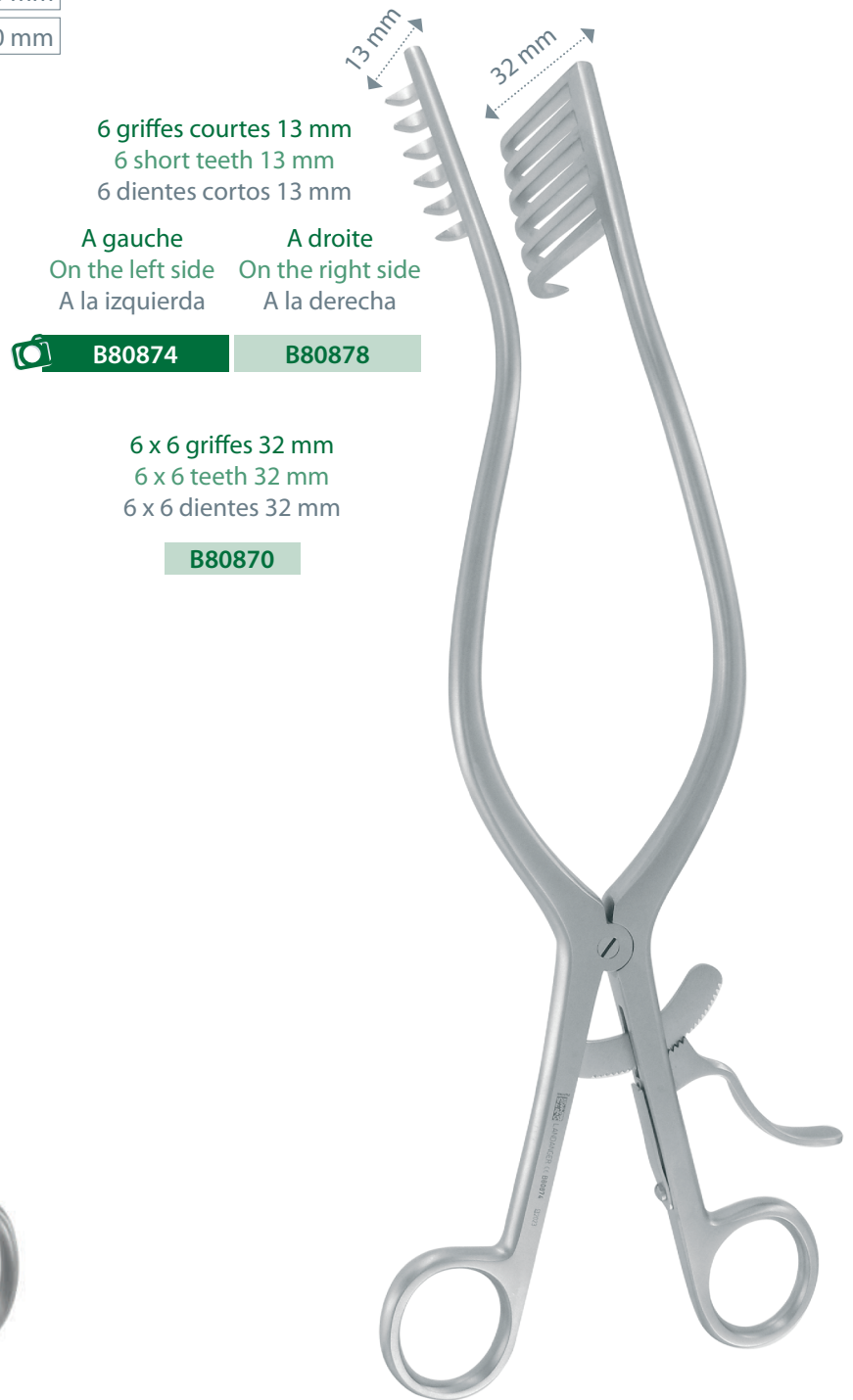

6 griffes courtes 13 mm
6 short teeth 13 mm
6 dientes cortos 13 mm

A gauche A droite
On the left side On the right side
A la izquierda A la derecha

B80874

B80878

6 x 6 griffes 32 mm
6 x 6 teeth 32 mm
6 x 6 dientes 32 mm

B80870

B80874
27 cm - 10 1/2"

WALTON

Pour hémilaminectomie
For hemilaminectomy
Para hémilaminectomía

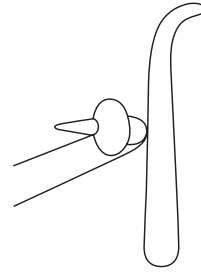
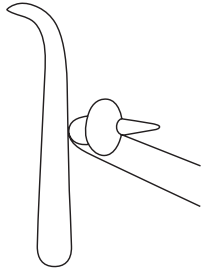

Griffes à gauche
Teeth on the left side
Dientes a la izquierda



Griffes à droite
Teeth on the right side
Dientes a la derecha

Pointue
Sharp
Aguda



B80860
20 cm - 8"



B80865
20 cm - 8"

MARKHAM-MEYERDING

Gauche Left Izquierda	Droite Right Derecha	Pointu Sharp Agudo >	Mousse Blunt Romo ⊔
42 mm	22 mm	B808506	B808505
22 mm	42 mm	B808508	B808507 

42 x 26 mm
Valve à gauche
Blade on the left side
Valva a la izquierda



B808570
18 cm - 7"

42 x 26 mm
Valve à droite
Blade on the right side
Valva a la derecha



B808571
18 cm - 7"



B808507
29 cm - 11 1/2"

WILLIAMS

18 cm - 7"  **B808564** 70 x 10 mm
 18 cm - 7" **B808566** 70 x 20 mm

18 cm - 7"  **B808565** 70 x 10 mm
 18 cm - 7" **B808567** 70 x 20 mm

Valve à droite
 Blade on the right side
 Valva a la derecha

Valve à gauche
 Blade on the left side
 Valva a la izquierda



B808564
 18 cm - 7"



B808565
 18 cm - 7"



GELPI

13 cm - 5"

B808545

19 cm - 7 1/2"

B80855 

DEBAKEY

10 cm - 4"

B808551

12 cm - 4 3/4"

B808552 

17 cm - 6 3/4"

B808553



B80855
19 cm - 7 1/2"

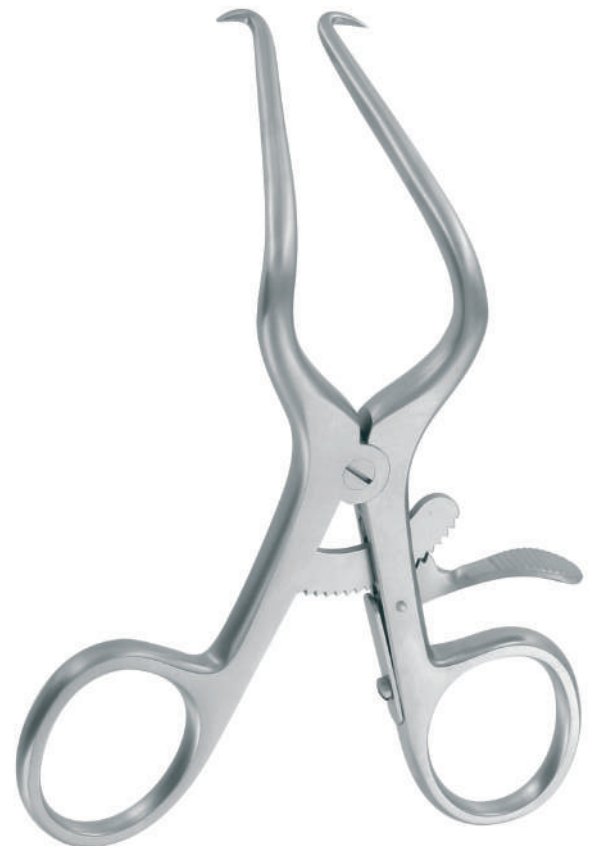

B808552
12 cm - 4 3/4"

JOLL

COURTY

Pour goître
For goitre
Para bocio



B80845
14,5 cm - 5 ³/₄"



B808460
19 cm - 7 ¹/₂"

Leviers pour os du pied et de la main
 Bone levers for foot and hand bones
 Elevadores para huesos del pie y de la mano

BUCK-GRAMCKO

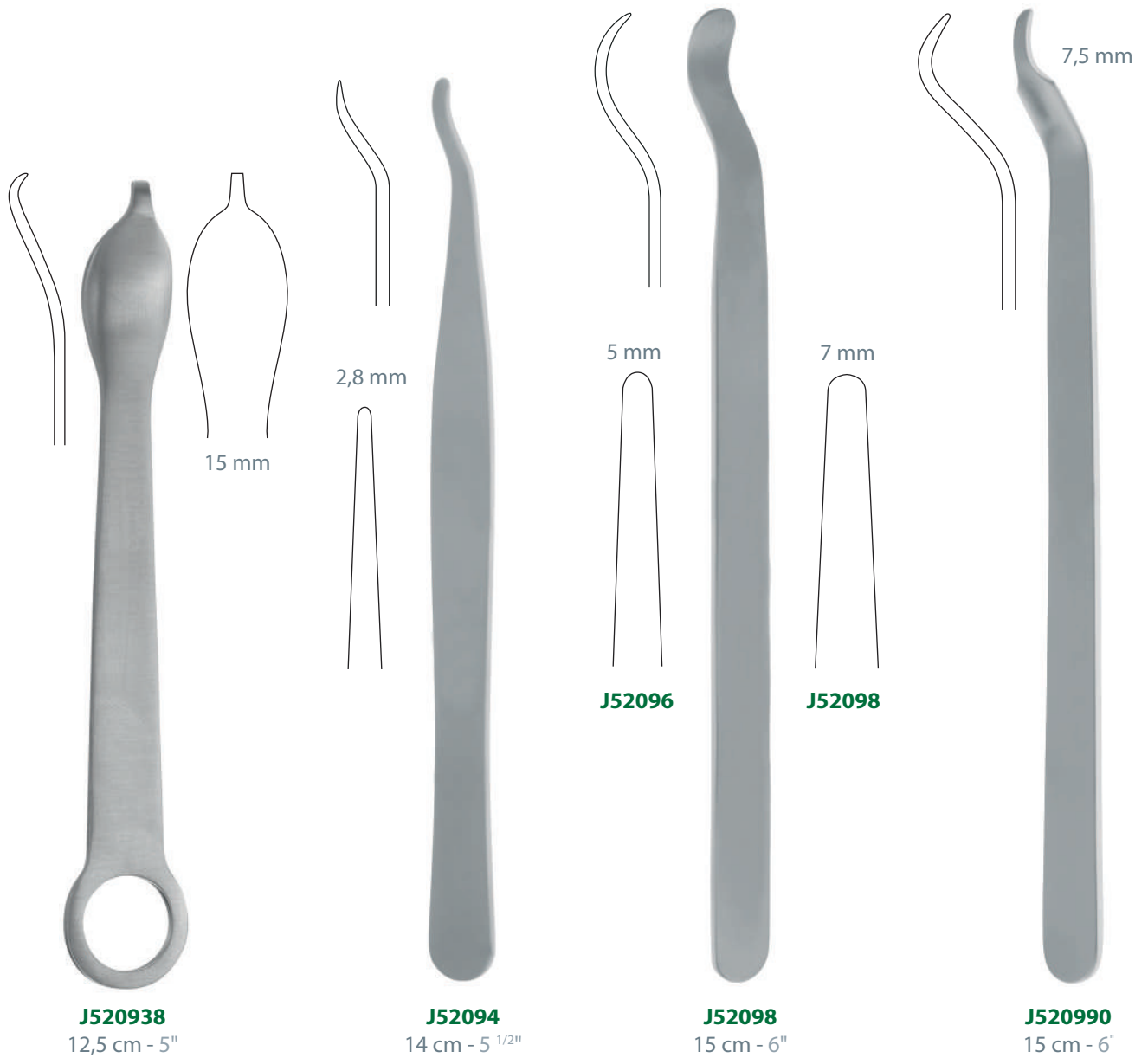

WAGNER



LANGE-HOHMANN

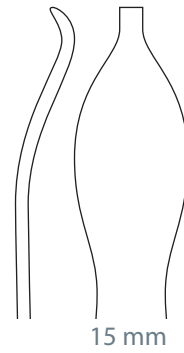
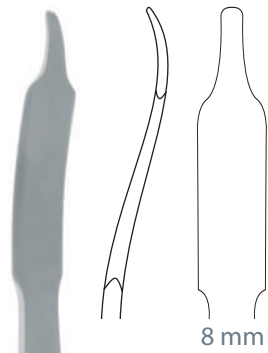
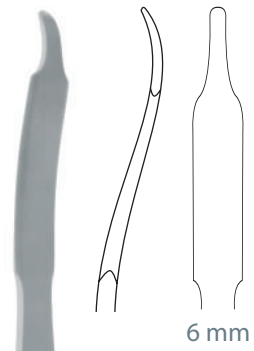

J52072
16 cm - 6 1/4"

J52074
16 cm - 6 1/4"

J520939
16 cm - 6 1/4"

J520770
22 cm - 8 3/4"



LANGE-HOHMANN

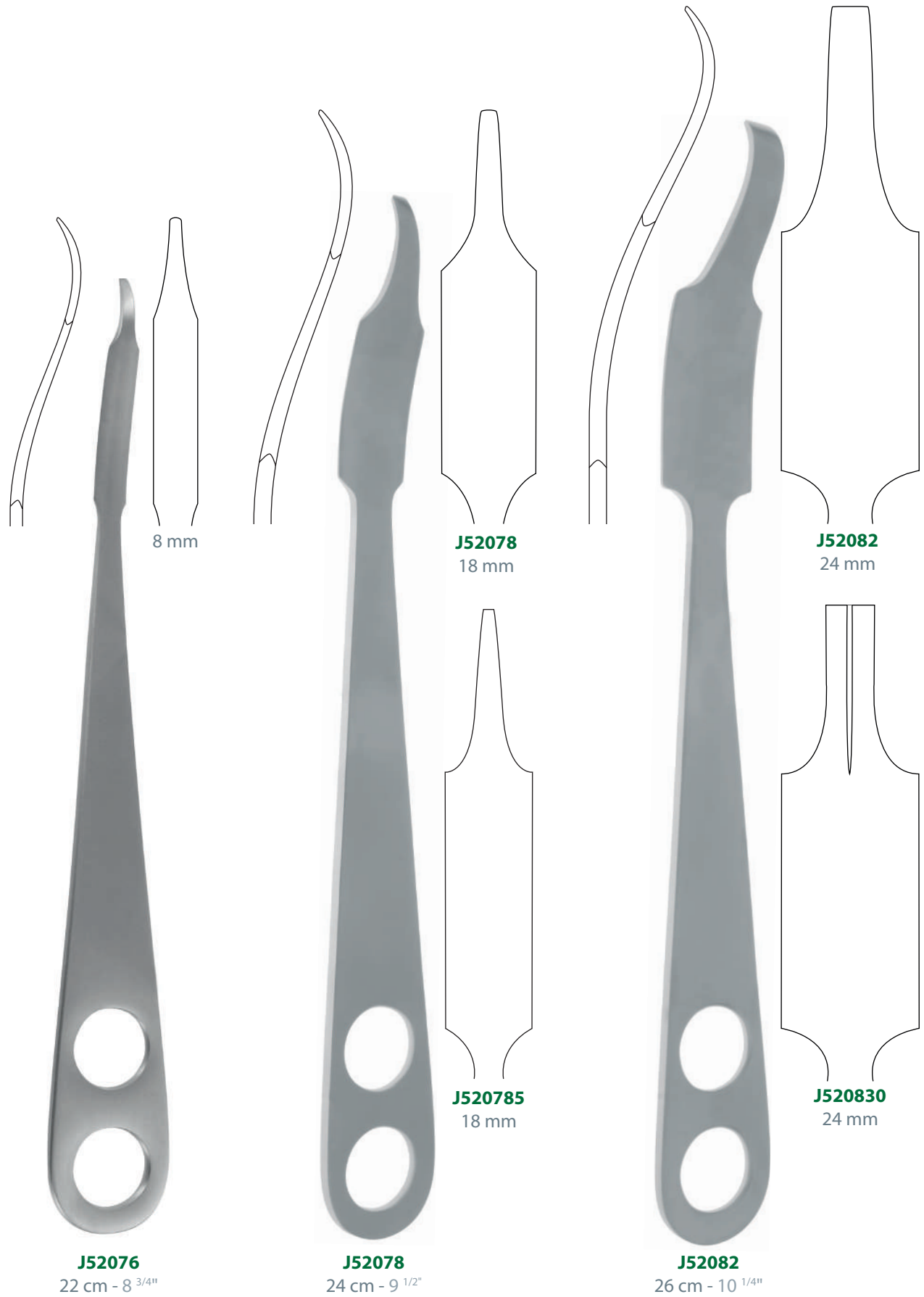

J52076
22 cm - 8 ³/₄"

J52078
24 cm - 9 ¹/₂"

J52082
26 cm - 10 ¹/₄"

8 mm

J52078
18 mm

J52082
24 mm

J520785
18 mm

J520830
24 mm

LANGE-HOHMANN

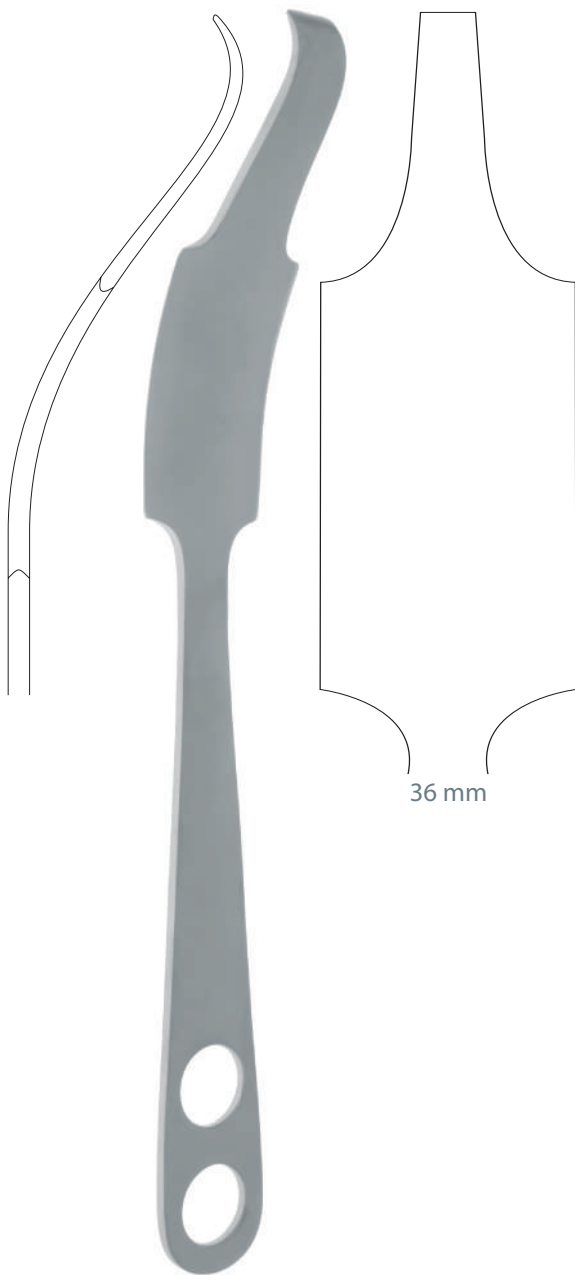

J52084
28 cm - 11"

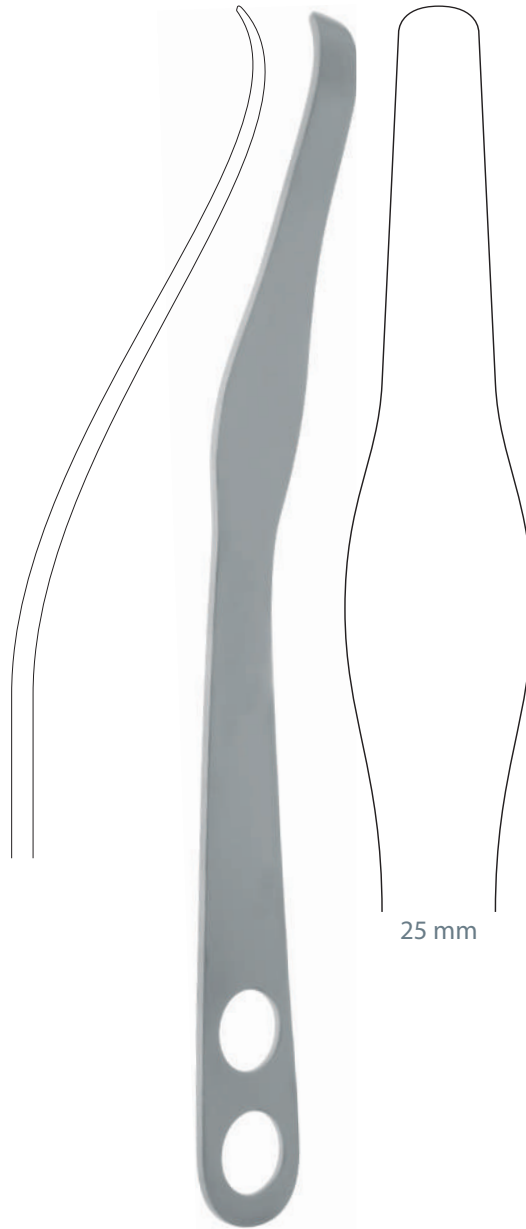

J52092
27 cm - 10 1/2"

VERBRUGGE-MULLER

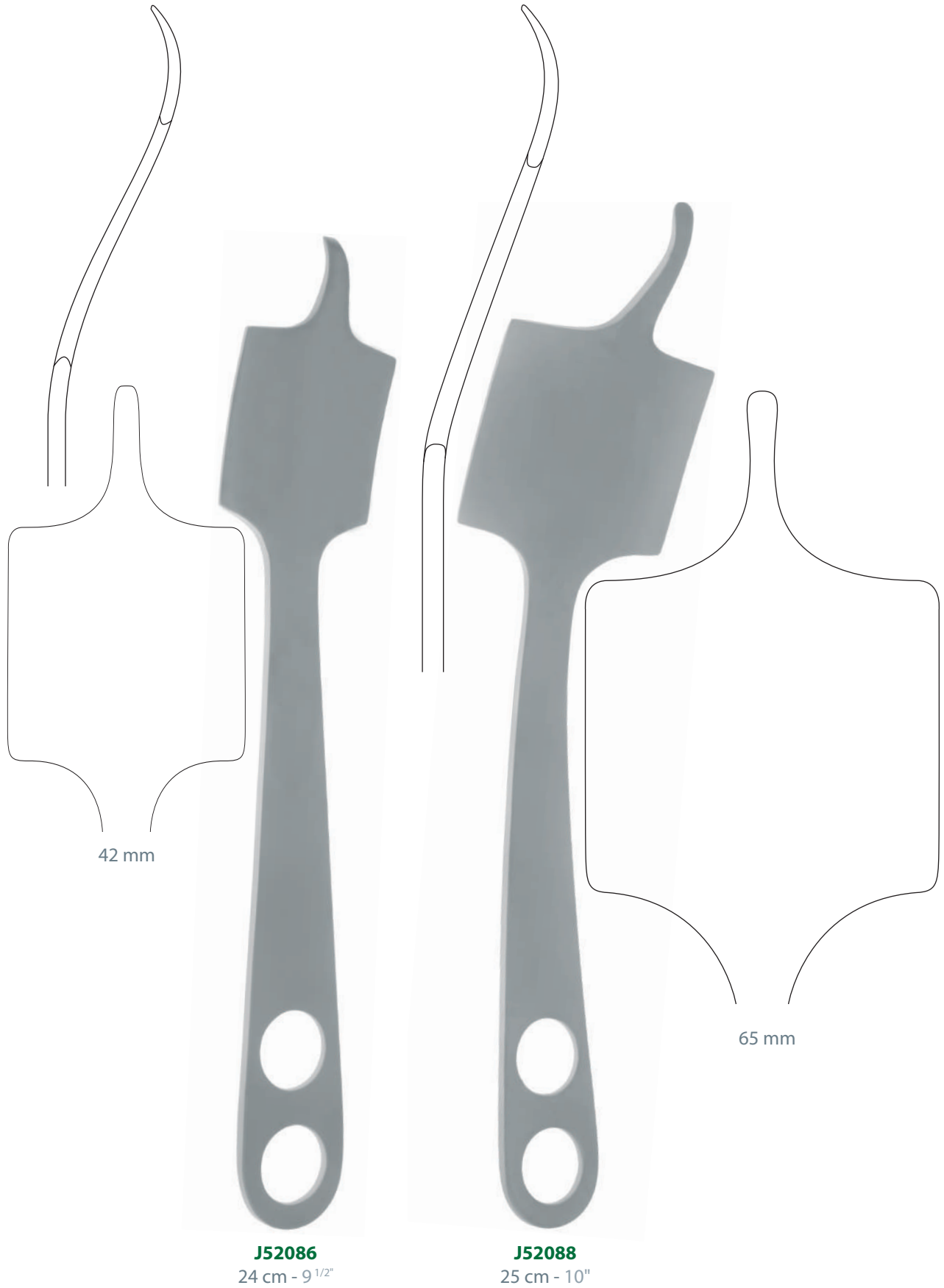

LANGE-HOHMANN

26,5 cm - 10 1/2"  **J520925** 30 mm
 29 cm - 11 1/2" **J520926** 33 mm



J520925
26,5 cm - 10 1/2"

HOHMANN ALDINGER

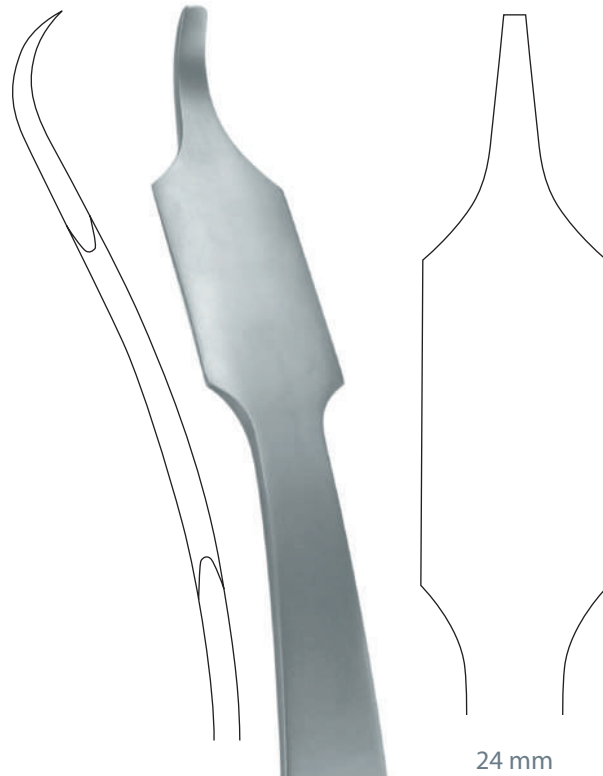

J520930
27 cm - 10 1/2"

18 mm
**SCHUMACHER
(WAGNER)**

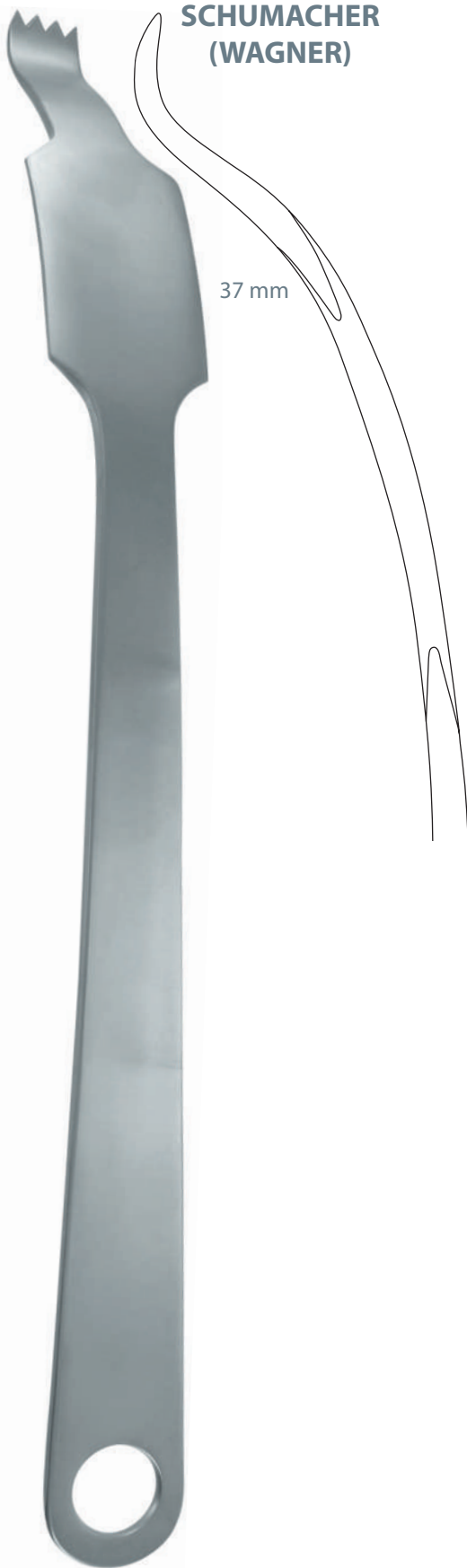

J520935
34,5 cm - 13 1/2"

SCHUMACHER

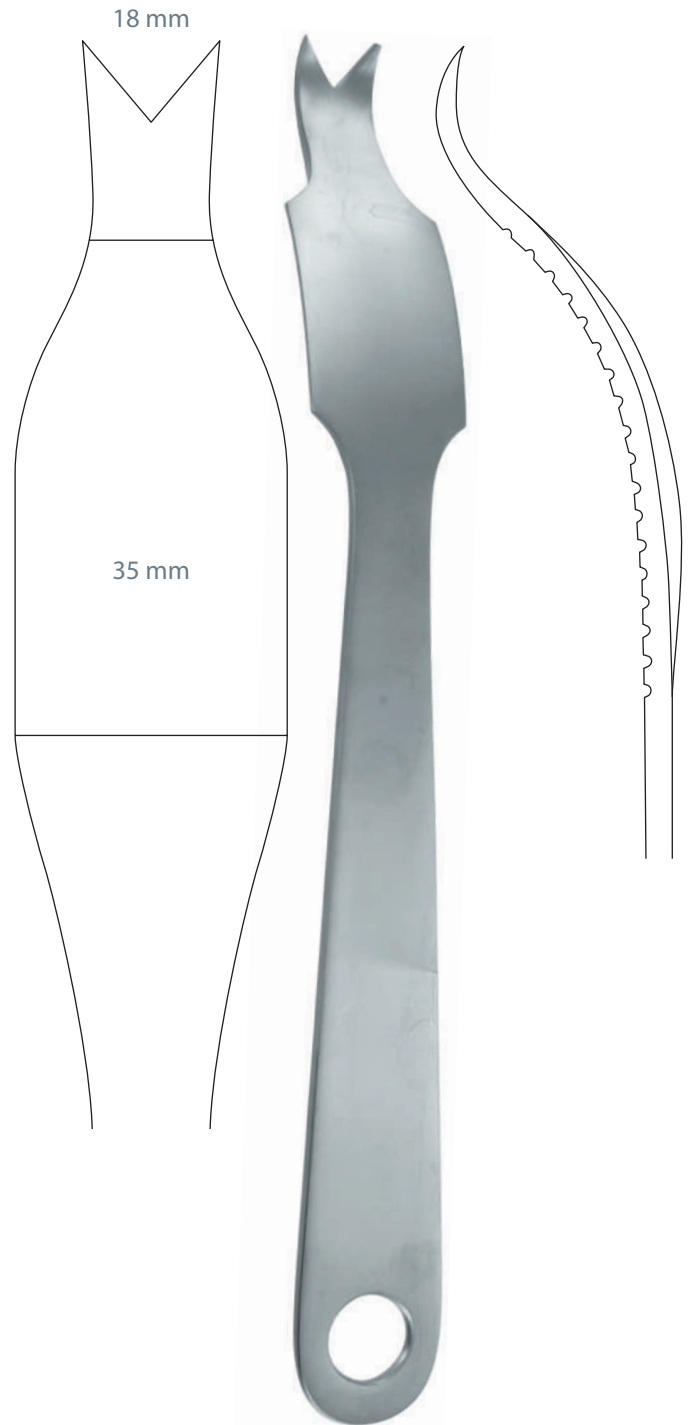

J520936
29 cm - 11 1/2"

MERLE D'AUBIGNE

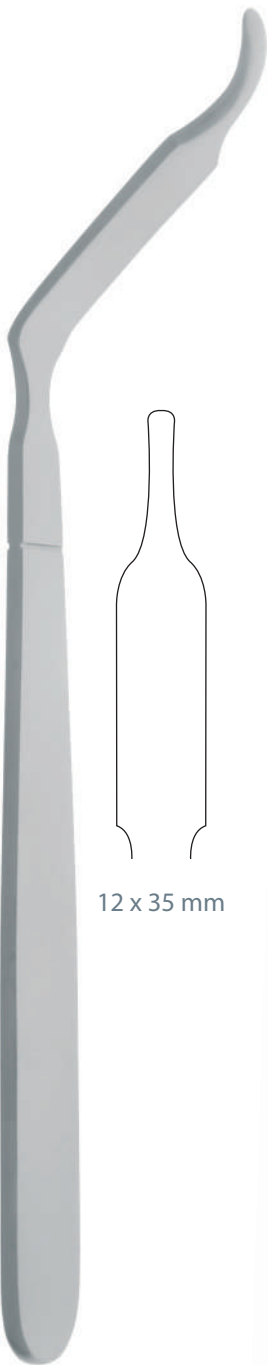

12 x 35 mm

J52050
18 cm - 7"



16 x 60 mm **J52060**
20 x 60 mm **J52070**

J52060
20 cm - 8"



J520230
20 x 40 mm

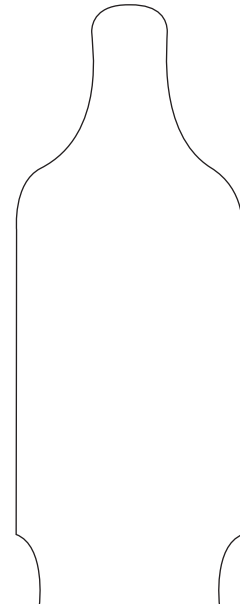



J520231
30 x 40 mm

J520230
22 cm - 8 3/4"

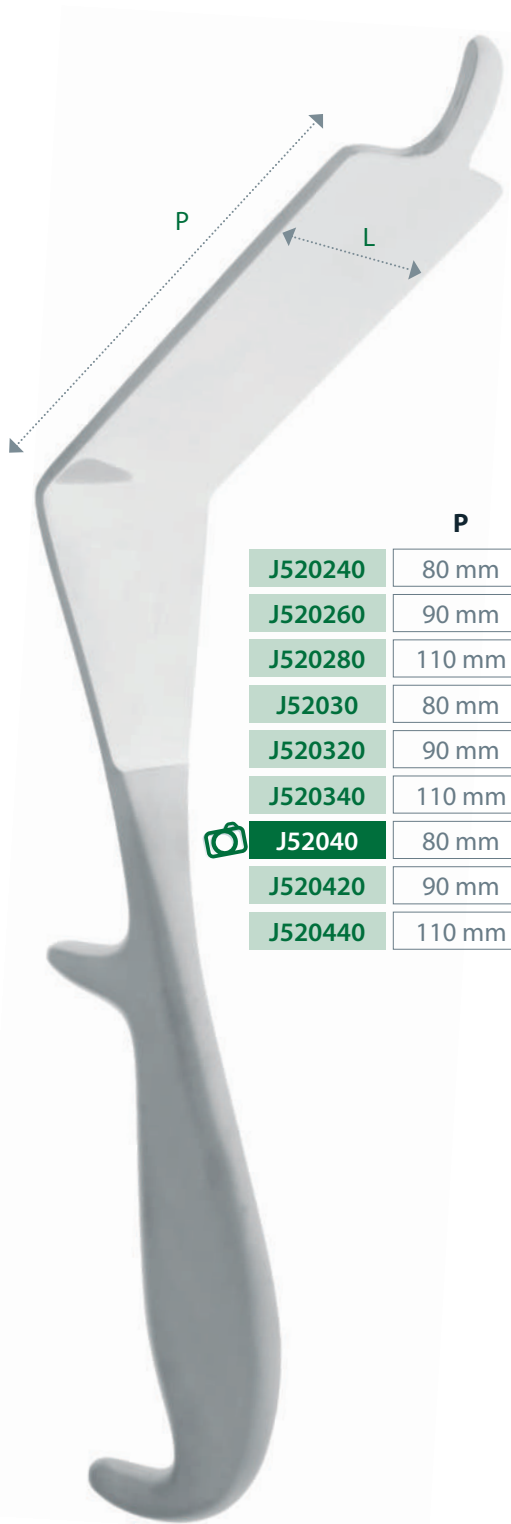

MERLE D'AUBIGNE



	P	L
J520240	80 mm	20 mm
J520260	90 mm	20 mm
J520280	110 mm	20 mm
J52030	80 mm	30 mm
J520320	90 mm	30 mm
J520340	110 mm	30 mm
 J52040	80 mm	50 mm
J520420	90 mm	50 mm
J520440	110 mm	50 mm

J52040
25 cm - 10"

JUDET



J520450

P	L
60 mm	33 mm

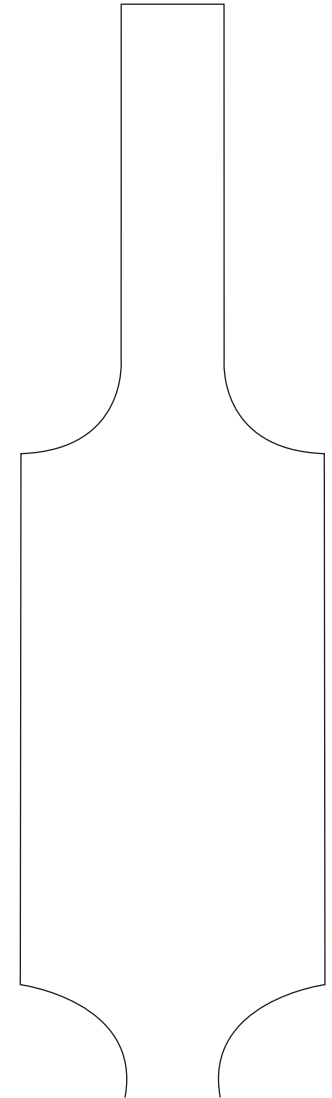

J520450
31,5 cm - 12 1/4"

LANDANGER

Écarteurs - Retractors - Separadores

CHANDLER

18 cm - 7"	J521001	13 mm
20 cm - 8" 	J521002	19 mm
23 cm - 9"	J521003	25 mm
25 cm - 10"	J521004	30 mm

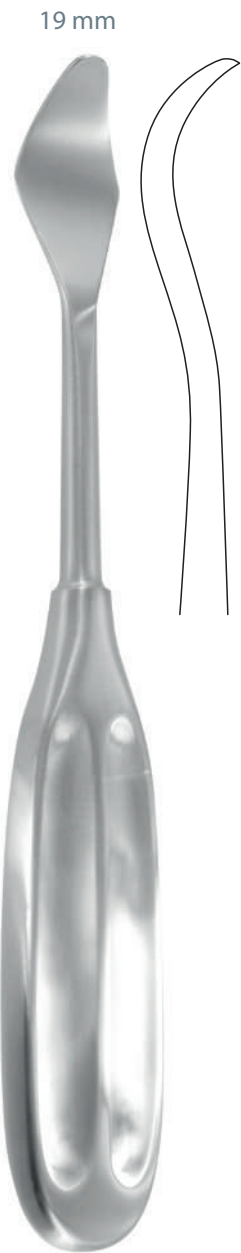

J521002
20 cm - 8"

LANE TRETOWAN



J521010
21,5 cm - 8 1/2"

LANE



J521015
25,5 cm - 10"

BRISTOW



J521020
23 cm - 9"

BLOUNT

FUKUDA



J521030
27 cm - 10 1/4"



J521035
26 cm - 10 1/4"



J521040
22,5 cm - 9"

BENNET

TRILLAT

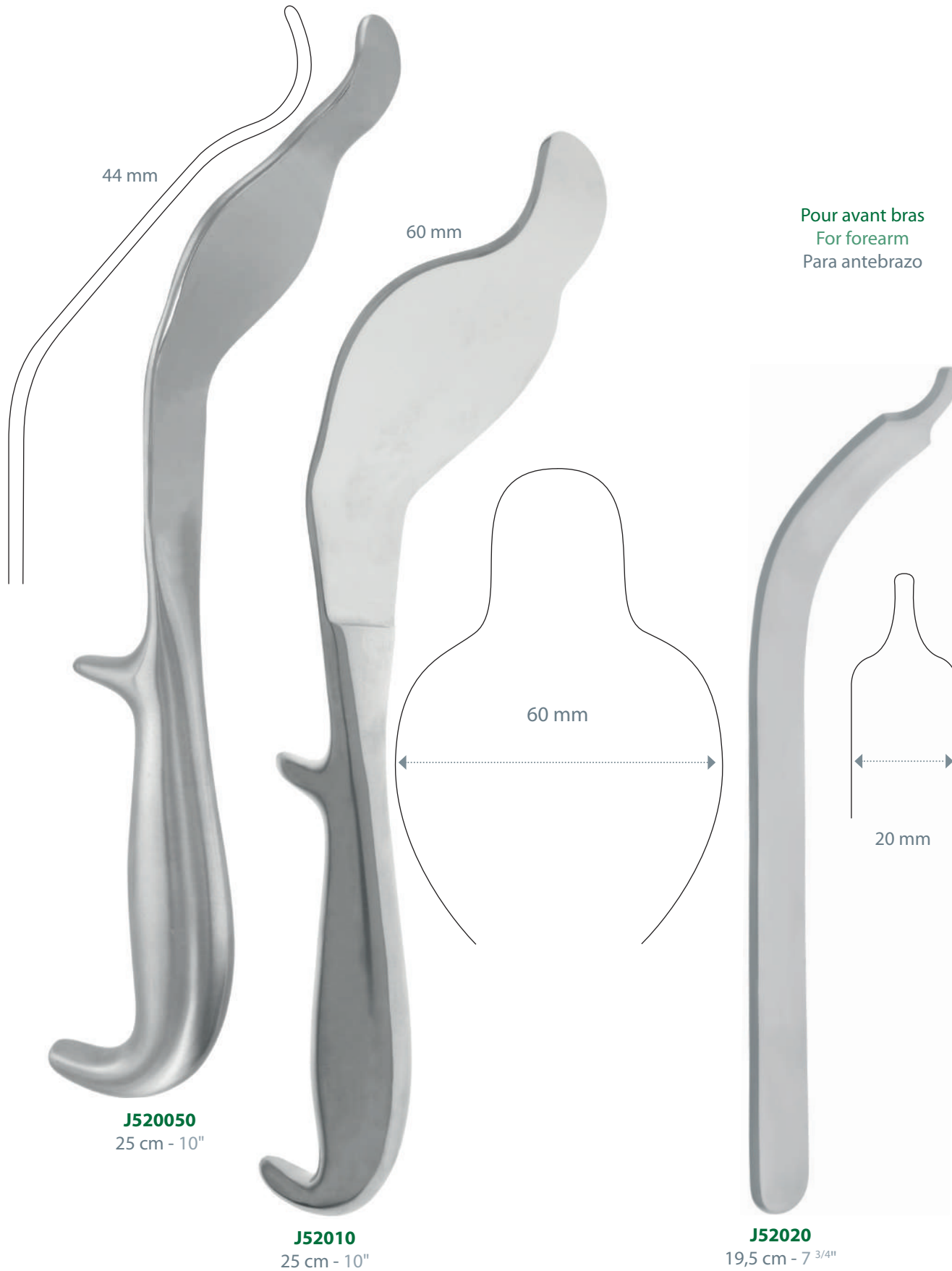

CAUCHOIX

	P	L
J52210	60 mm	35 mm
 J52220	80 mm	35 mm
J52230	100 mm	40 mm
J522400	150 mm	40 mm

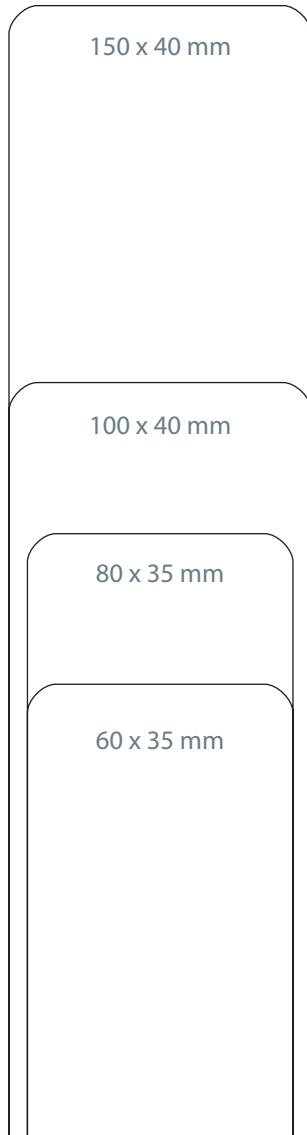

J52220
23 cm - 9"

SKID MURPHY



J52130
34 cm - 13 1/2"

LAMBOTTE



J52150
31 cm - 12 1/4"

MOORE LAMBOTTE

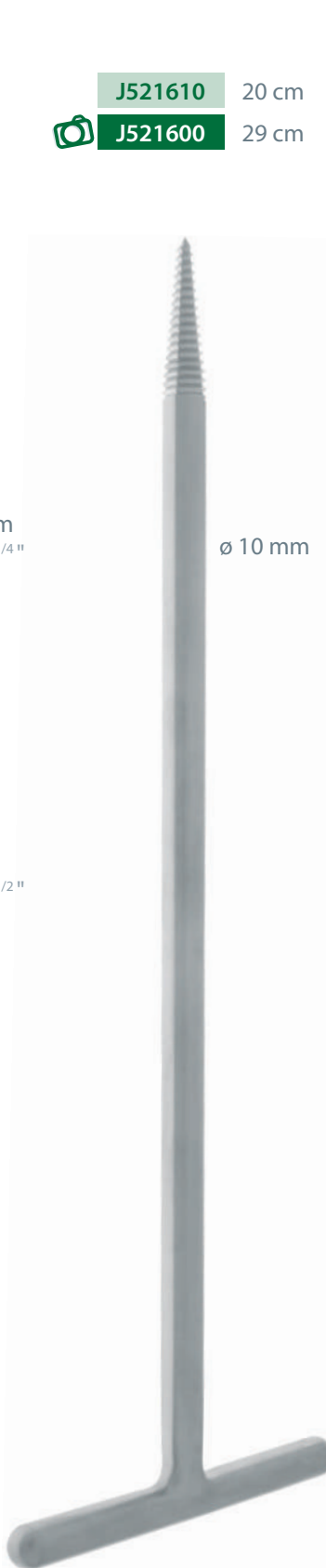

J52160
29 cm - 11 1/2"

-  **J521400** 26 cm
- J521410** 31 cm



J521400
26 cm - 10 1/4"

33 mm

J521610 20 cm

 **J521600** 29 cm

Double
Double
Doble

J52150
18 x 33 mm
31 cm - 12 1/4"

Simple
Simple
Simple

J521505
33 mm
29 cm - 11 1/2"

ø 10 mm

26 mm

18 mm

POSTEL

MAURER



J52170
19,5 cm - 8"



J521750
27 cm - 10 ³/₄"



Pinces utérines - Uterines forceps - Pinzas uterinas

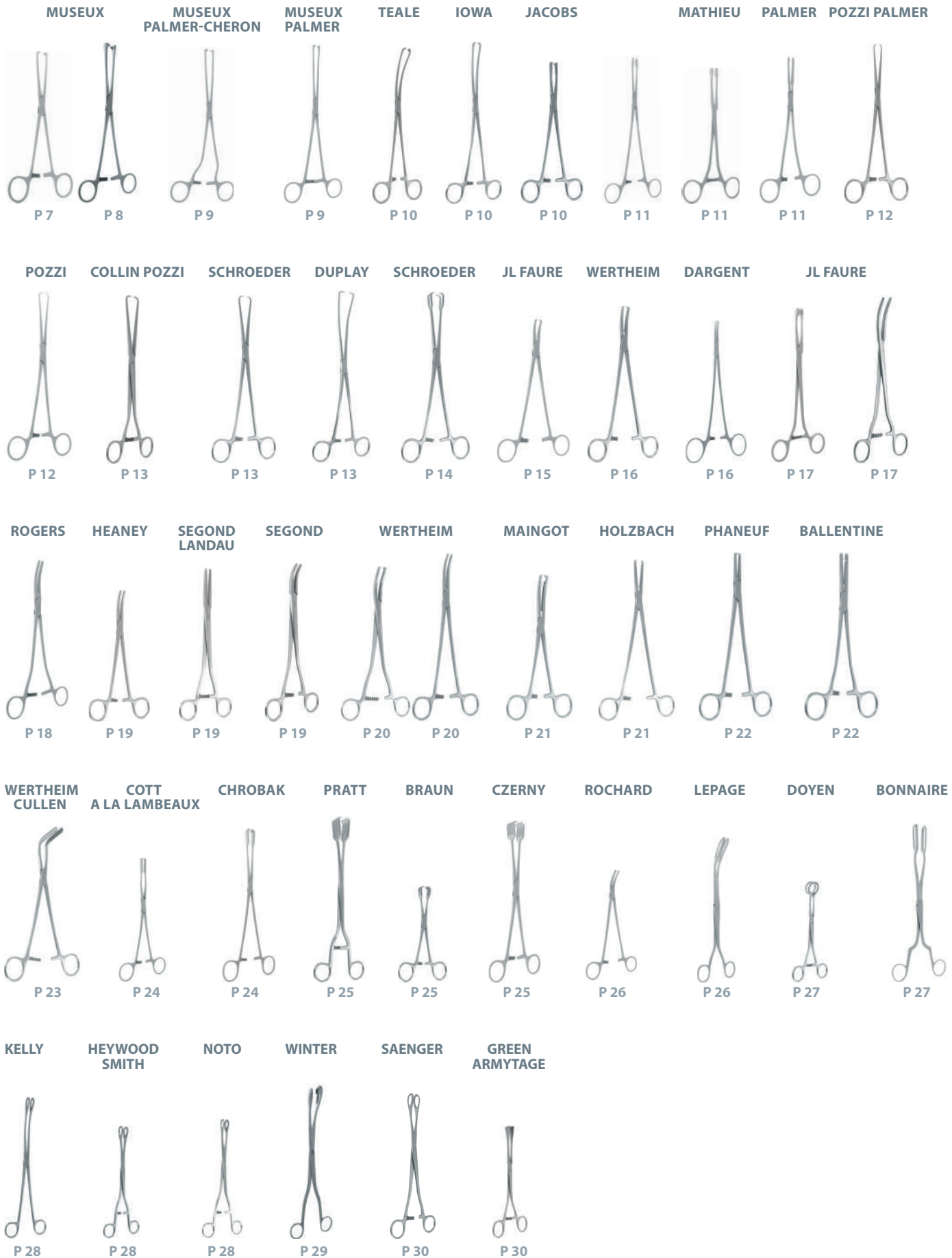

Spéculums vaginaux - Vaginal speculas - Espéculos vaginales

COLLIN JAYLE CUSCO Spéculum pour vierge
Virgin specula
Espéculo para virgen CUSCO GRAVE PEDERSON SEYFFERT SEMM



P 31 P 32 P 33 P 33 P 34 P 34 P 35 P 35 P 35

Endospéculums - Endospeculas - Endoespéculos

SCHERBAK

KOGAN



P 50

P 36

Valves vaginales - Vaginal blades - Valvas vaginales

DOYEN

MANGIAGALLI

DOUGLAS

DARGENT

LANDAU

BREISKY



P 37 P 38 P 38 P 39 P 39 P 40 P 41 P 41 P 42 P 43 P 43

JACKSON

KRISTELLER

SIMS

DOYEN

MATHIEU

ST-MARKS

JAYLE

AUVARD

SCHERBAK



P 44 P 44 P 45 P 46 P 46 P 47 P 48 P 49 P 50

Amnioscopes - Amnioscopes - Amnioscopo



P 51

Pince hystérolable - Uterine elevating forceps - Pinzas para coger el útero

COLLIN DARTIGUES SOMMER

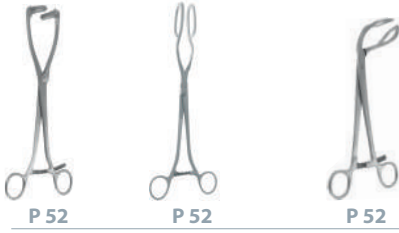

Forceps spatules - Obstetrical forceps - Forceps obstétricos



Divers - Miscellaneous - Diverso

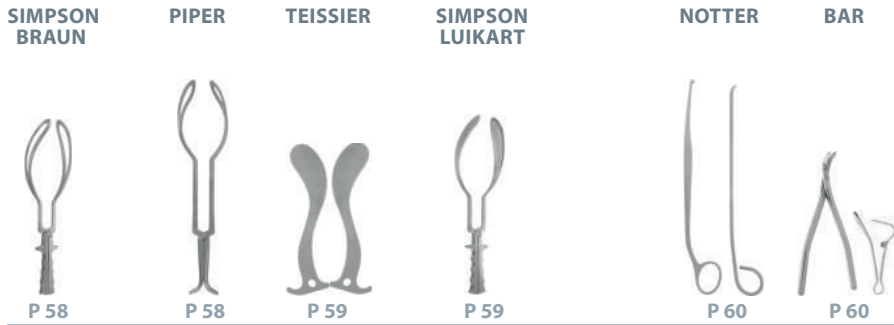

Ventouse obstétricale - Obstetric vacuum cup - Ventosa obstétrica



P 61

Pinces à biopsie - Biopsy forceps - Pinzas para biopsia

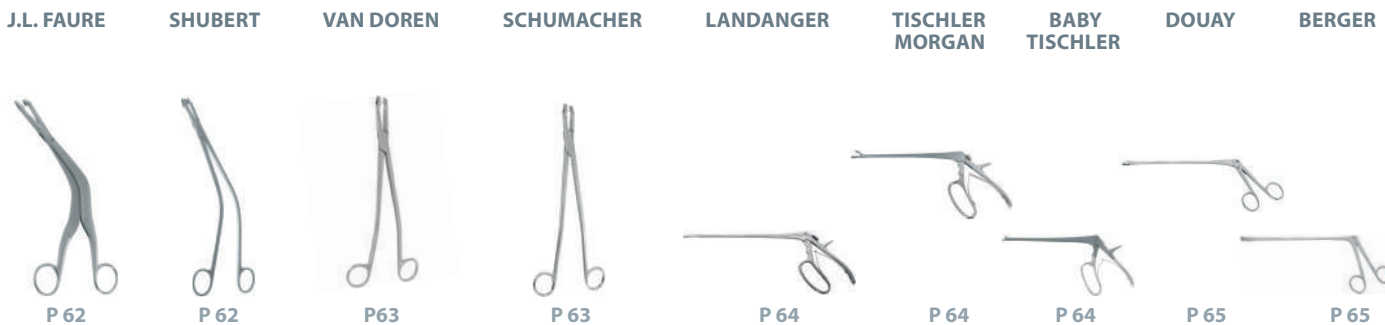

Pinces à biopsie - Biopsy forceps - Pinzas para biopsia

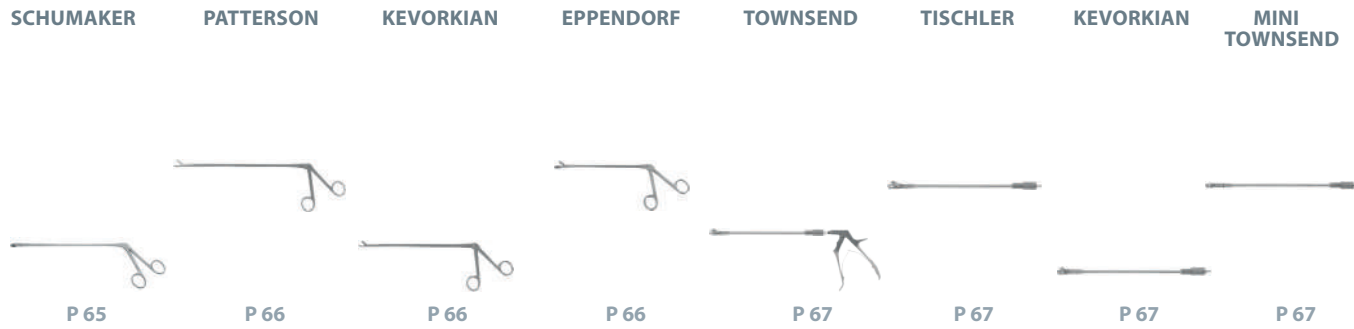

Curettes utérines - Uterines curettes - Curetas uterinas



Curettes à biopsie - Biopsy curettes - Curetas para biopsia

KEVORKIAN



P 77

Pelvimètres - Pelvimeters - Pelvimetros

MARTIN

BRIESKY



P 78



P 78

Divers - Miscellaneous - Diverso

SCHULTZE BRAUN NOVACK POZZI CIRCERON THERUM IVG DOYEN

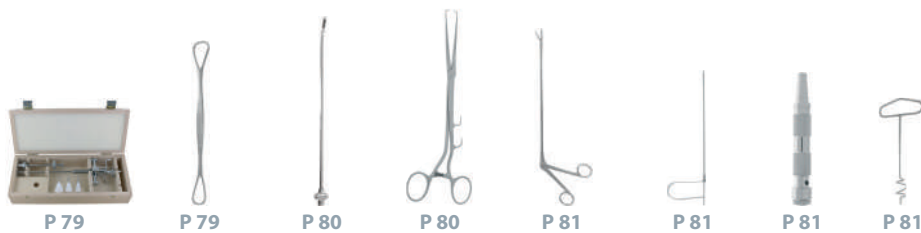

Dilatateurs utérins - Uterine dilators - Dilatadores uterinos

HEGAR PALMER HEGAR HANK PRATT



Hysteromètres - Uterine sounds - Hysterómetros

VALLEIX SIMS MARTIN
SIMPSON



Instruments pour urologie - Instruments for urology - Instrumentos para urología

GUYON Sondes métalliques
Metal catheters
Sondas metálicas



P 86



P 86



P 86

Spéculum rectaux - Rectal speculas - Espéculos rectales

PRATT MATHIEU TRELAT CZERNY SIMS



P 87



P 87



P 87



P 88



P 88



P 88

Anusscopes - Anusscopes - Anuscopios

KELLY BENSUAUDE Sphinctéroscope
Sphincteroscope
Esfinteroscopio



P 89



P 89



P 89

Écarteurs rectaux - Rectal retractors - Separadores rectales

BARR HALLE ALAN PARKS



P 90



P 90



P 91

Biopsie rectale - Biopsy forceps - Biopsia rectal

YEOMAN



P 92

Pincés pour vasectomie - Vasectomy forceps - Pinzas para vasectomia



P 93



P 93

Pincés hémorroïdales - Haemorrhoidal forceps - Pinzas hemorroidales

HEYWOOD SMITH MC GIVNEY



P 94



P 94

Instruments pour prostate - Instruments for prostate - Instrumentos para prostate



Ciseaux pour intervention en profondeur - Scissors for deep operations - Tijeras para intervención a fondo

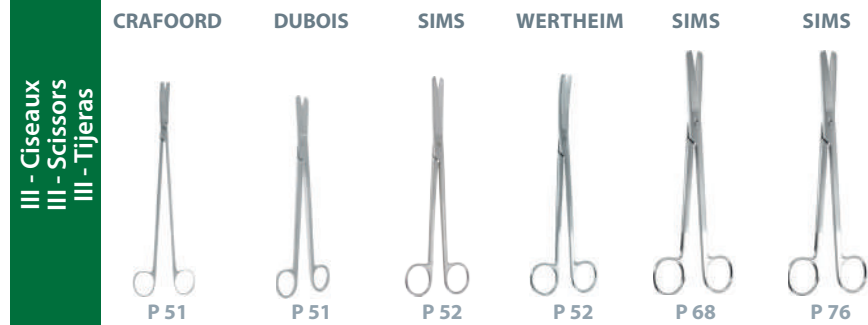

Ciseaux pour le cordon ombilical - Scissors for umbilical cord - Tijeras para el cordón umbilical

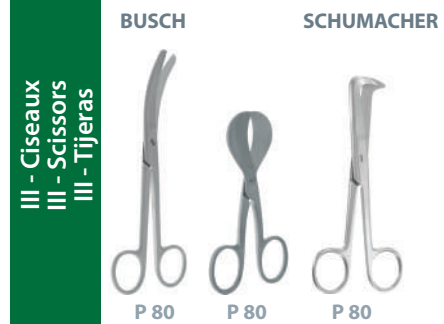

Ciseaux à épisiotomie - Episiotomy scissors - Tijeras episiotomía

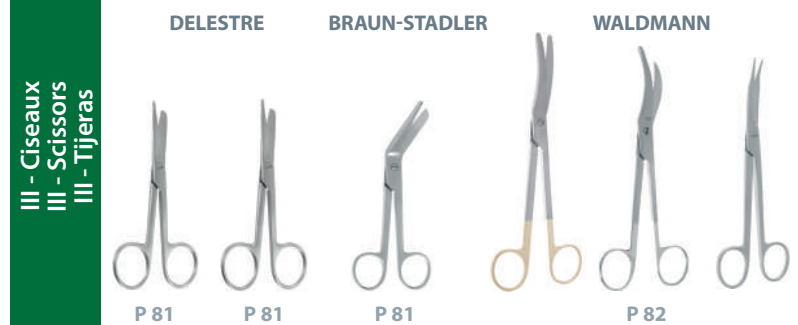

MUSEUX

Droite
Straight
Recta

14 cm - 5 1/2"

F10340

16 cm - 6 1/4"

F10350



18 cm - 7"

F10360



F10350
16 cm - 6 1/4"



F10360
18 cm - 7"

MUSEUX

Courbe latérale
Lateral curved
Curva lateral

4 griffes
4 teeth
4 dientes

	F10380 7 mm		F103801 7 mm	
	F10390 9 mm		F103901 9 mm	
	F10400 11 mm		F104001 11 mm	
	F104100 11 mm			
				6 griffes 6 teeth 6 dientes
F10400 24 cm - 9 1/2"			F103901 24 cm - 9 1/2"	

MUSEUX PALMER-CHERON

MUSEUX PALMER



F10420
23 cm - 9"



F10450
24 cm - 9 1/2"

TEALE

IOWA

JACOBS

Pour la vésicule amniotique
For the amnion bladder
Para la vesícula amniótica

Courbe latérale
Lateral curved
Curva lateral



6 mm

Double courbure
Double curvature
Doble curvatura



7,6 mm



6 mm



F10517
23 cm - 9"



F105175
26 cm - 10^{1/4}"



F105185
21 cm - 8^{1/4}"

Pinces utérines à polypes - Uterines polypus forceps - Pinzas uterinas para polipos

MATHIEU

PALMER

Pinces à polypes
Polypus forceps
Pinzas para polipos

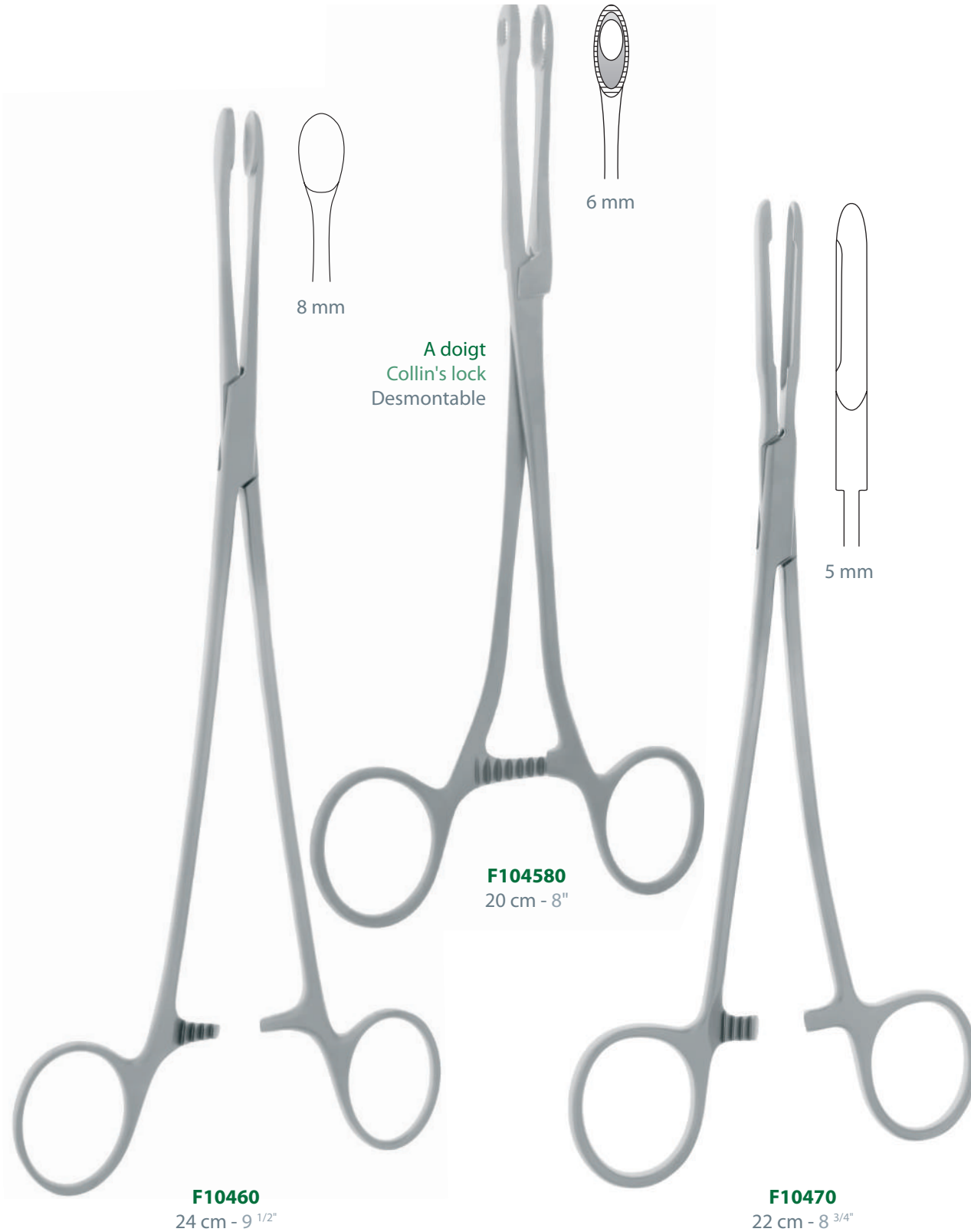

F10460
24 cm - 9 1/2"

F104580
20 cm - 8"

F10470
22 cm - 8 3/4"

A doigt
Collin's lock
Desmontable

POZZI PALMER

POZZI



F10480
23 cm - 9"



F10505
18 cm - 7"



F10515
24 cm - 9 1/2"

COLLIN POZZI

SCHROEDER

DUPLAY



A vis
With screw
Con tornillo

F105151
25 cm - 10"



F105152
25 cm - 10"



Double courbure
Double curvature
Doble curvatura

F105153
28 cm - 11"



SCHROEDER



Courbe
Curved
Curva

Courbe latérale
Lateral curved
Curva lateral

F10516
25 cm - 10"

F105155
25 cm - 10"

F105165
25 cm - 10"

JL FAURE

Modèle léger
Light model
Modelo ligero



F10550
21 cm - 8 1/4"

Modèle fort
Strong model
Modelo pesado

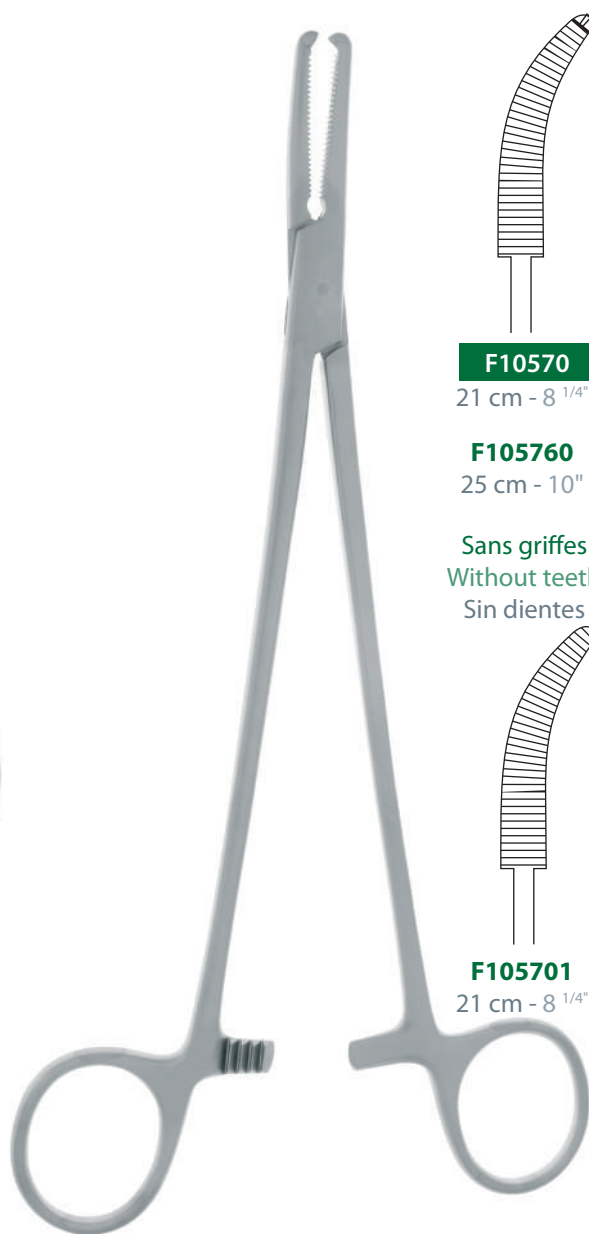

F10570
21 cm - 8 1/4"

A griffes
With teeth
Con dientes

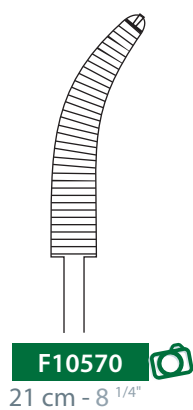

F10570
21 cm - 8 1/4"

F105760
25 cm - 10"

Sans griffes
Without teeth
Sin dientes

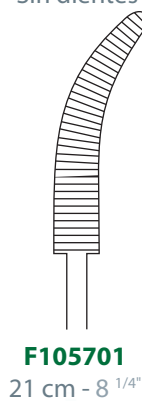

F105701
21 cm - 8 1/4"

WERTHEIM

DARGENT

Dissecteur
Dissector
Disector

1/2 Courbe
1/2 Curved
1/2 Curva



 F105970

Courbe
Curved
Curva

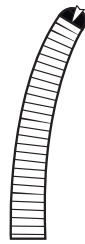

F105971



F105970
23 cm - 9"



F105450
20 cm - 8"

JL FAURE

A plateaux
With plates
Con platos



10 mm

A doigt
Collin's lock
Desmontable

F10580
22 cm - 8 3/4"

A ligament large
For wide ligament
Para ligamento ancho

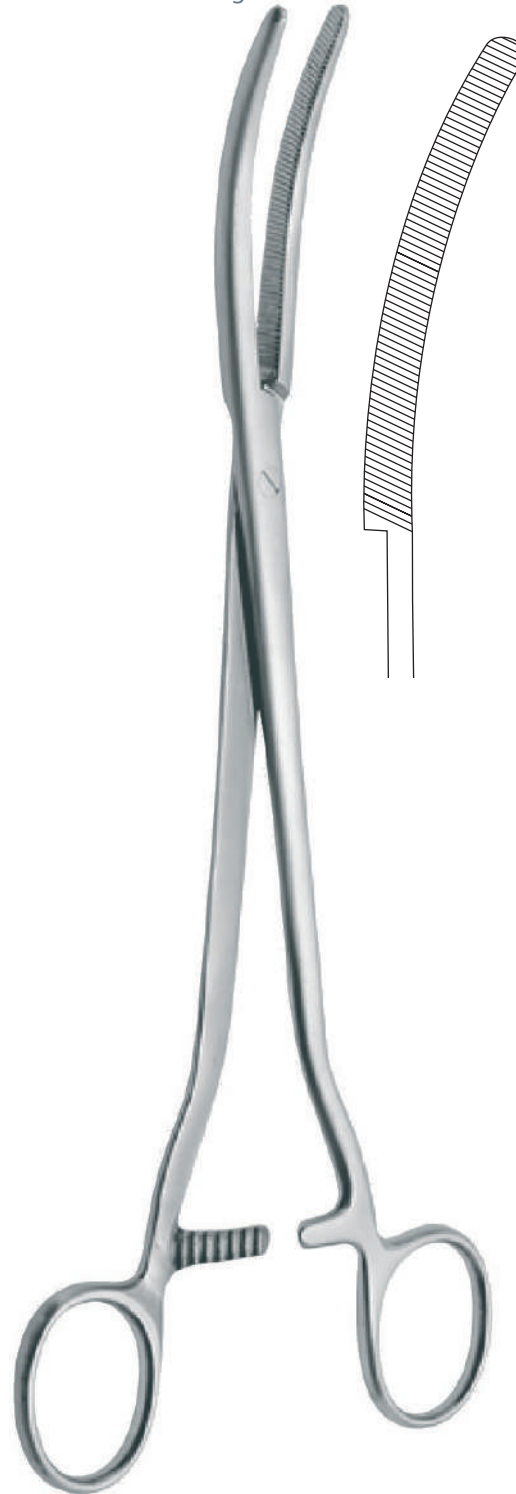

F10590
25 cm - 10"

ROGERS

	Droite Straight Recta	1/2 Courbe 1/2 Curved 1/2 Curva	Courbe Curved Curva	Coudée Angular Angulada			
22,5 cm - 8 3/4"	F105910	22 cm - 8 1/2"	F105911	21,5 cm - 8 1/2"	F105912	20,5 cm - 8"	F105913
25 cm - 10"	F105920	24,5 cm - 9 2/3"	F105921 	24 cm - 9 1/2"	F105922	23 cm - 9"	F105923

Mors atraumatique
Atraumatic jaws
Bocas atraumáticas



F105921
24,5 cm - 9 2/3"

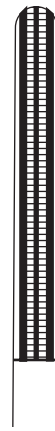

F105920
25 cm - 10"

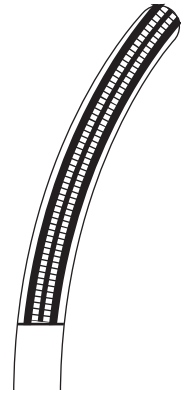

F105921
24,5 cm - 9 3/4"

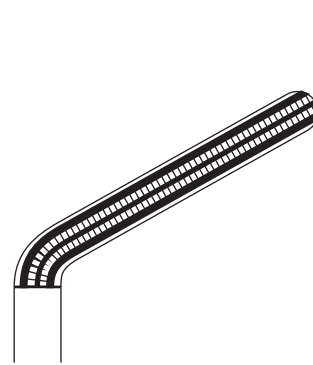

F105923
23 cm - 9"



F105922
24 cm - 9 1/2"

Pinces utérines - Uterines forceps - Pinzas uterinas

HEANEY

2 dents
2 teeth
2 dientes



F105930 19,5 cm - 7 1/2"

F105932 21 cm - 8 1/4"

F105934 23 cm - 9"

SEGOND-LANDAU

1 dent
1 tooth
1 diente

F105931

F105933

F105935



A vis
With screw
Con tornillo

SEGOND

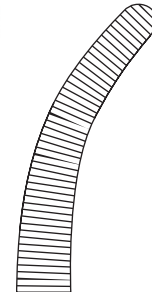

F105930
19,5 cm - 7 1/2"



F105940
24 cm - 9 1/2"



F105941
24 cm - 9 1/2"

WERTHEIM



A vis
With screw
Con tornillo

F105980
24 cm - 9 1/2"

F105981
25 cm - 10"

LANDANGER

Pinces utérines - Uterines forceps - Pinzas uterinas

MAINGOT

Courbe
Curved
Curva

20,5 cm - 8"

F105946



25 cm - 10"

F105945

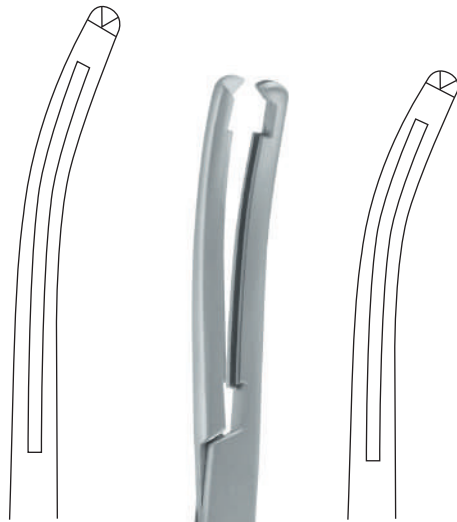

F105945

F105946

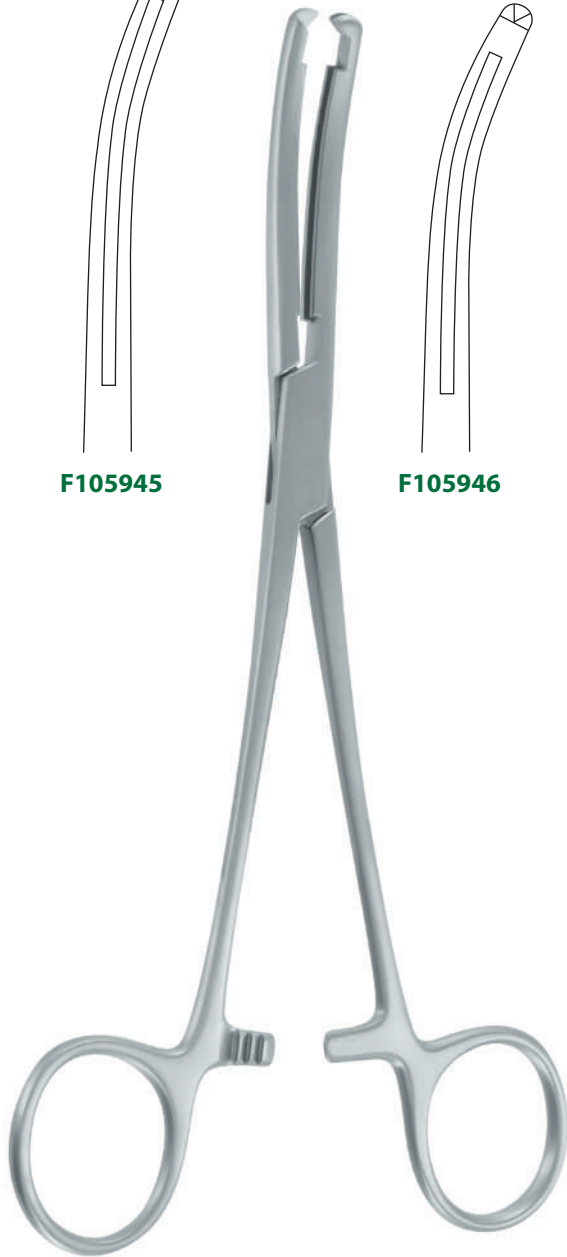

F105946
20,5 cm - 8"

HOLZBACH

Droite
Straight
Recta

Courbe
Curved
Curva

23,5 cm - 9 1/4"



F105948

F105949

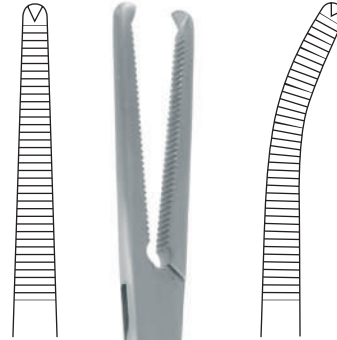

F105948
23,5 cm - 9 1/4"

Pinces utérines - Uterines forceps - Pinzas uterinas

PHANEUF

Droite
Straight
Recta

Coudée
Angular
Angulada

21,5 cm - 8 1/2"

F105950



F105951

BALLENTINE

Droite
Straight
Recta

Courbe
Curved
Curva



F105955

21 cm - 8 1/4"

F105956



F105950

21,5 cm - 8 1/2"

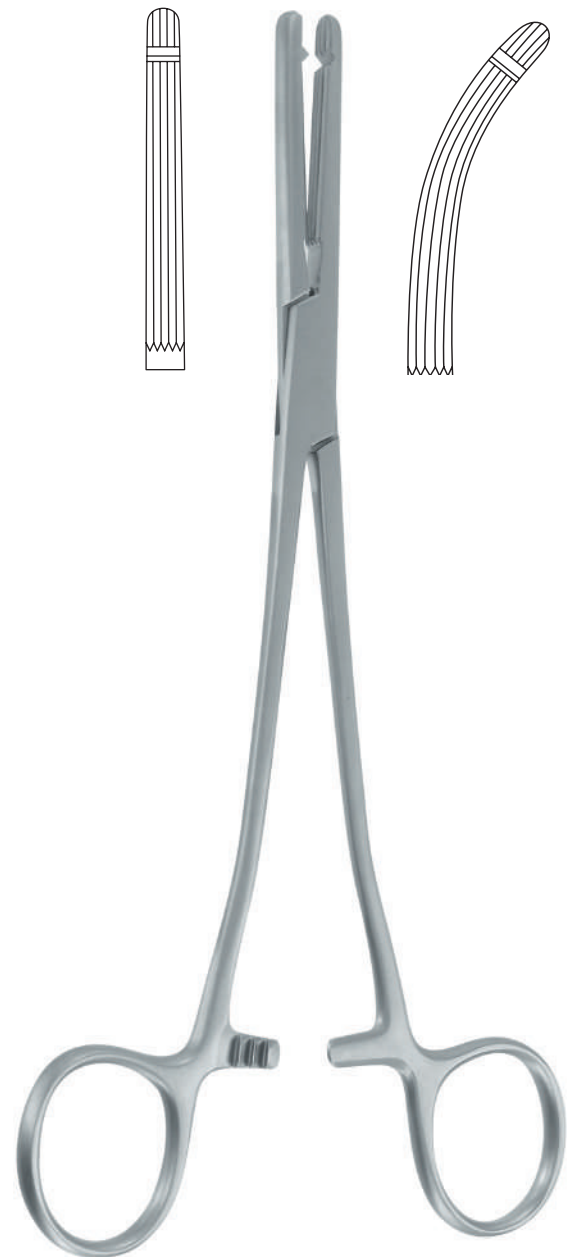

F105955

21 cm - 8 1/4"

WERTHEIM CULLEN



Pinces utérines - Uterines forceps - Pinzas uterinas

COTT (À LAMBEAUX)

Mors
Jaws
Bocas

22,5 cm - 8 ^{3/4}" **F106040** 4,5 mm
22 cm - 8 ^{2/3}" **F10605** 6,0 mm 

3 x 3 griffes
3 x 3 teeth
3 x 3 dientes

4,5 mm



6 mm



F10605
22 cm - 8 ^{2/3}"

CHROBAK

4 x 4 griffes
4 x 4 teeth
4 x 4 dientes



10 mm



F106060
26 cm - 10 ^{1/4}"

Pinces utérines - Uterines forceps - Pinzas uterinas

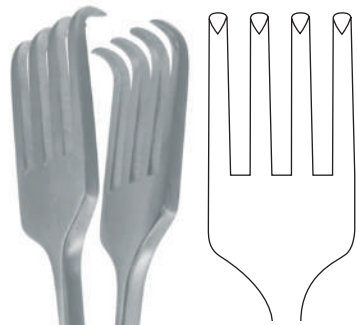
PRATT



A vis
With screw
Con tornillo



F108180
28 cm - 11"

BRAUN



F108190
15,5 cm - 6 1/4"

CZERNY

20,5 cm - 8"

F108200

26 cm - 10 1/4"

F108205

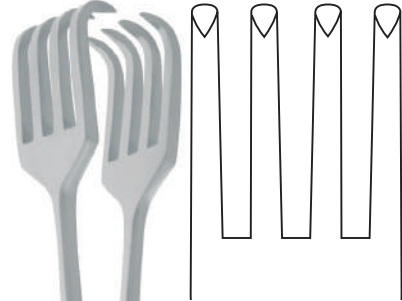

F108205
26 cm - 10 1/4"

ROCHARD



F10610
21 cm - 8 1/4"

LEPAGE



Pince à faux germes
Ovum forceps
Pinza para aborto

A tenon
With tenon lock
Con tenon

F10630
27 cm - 10 1/2"

Pinces utérines - Uterines forceps - Pinzas uterinas

DOYEN

Pince à ovaire
Ovarian forceps
Pinza para ovarios

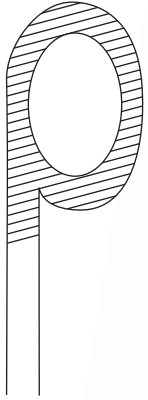

F10620
26 cm - 10 1/4"

A vis
With screw
Con tornillo



F106210
20 cm - 8"

A tenon
With tenon lock
Con tenon

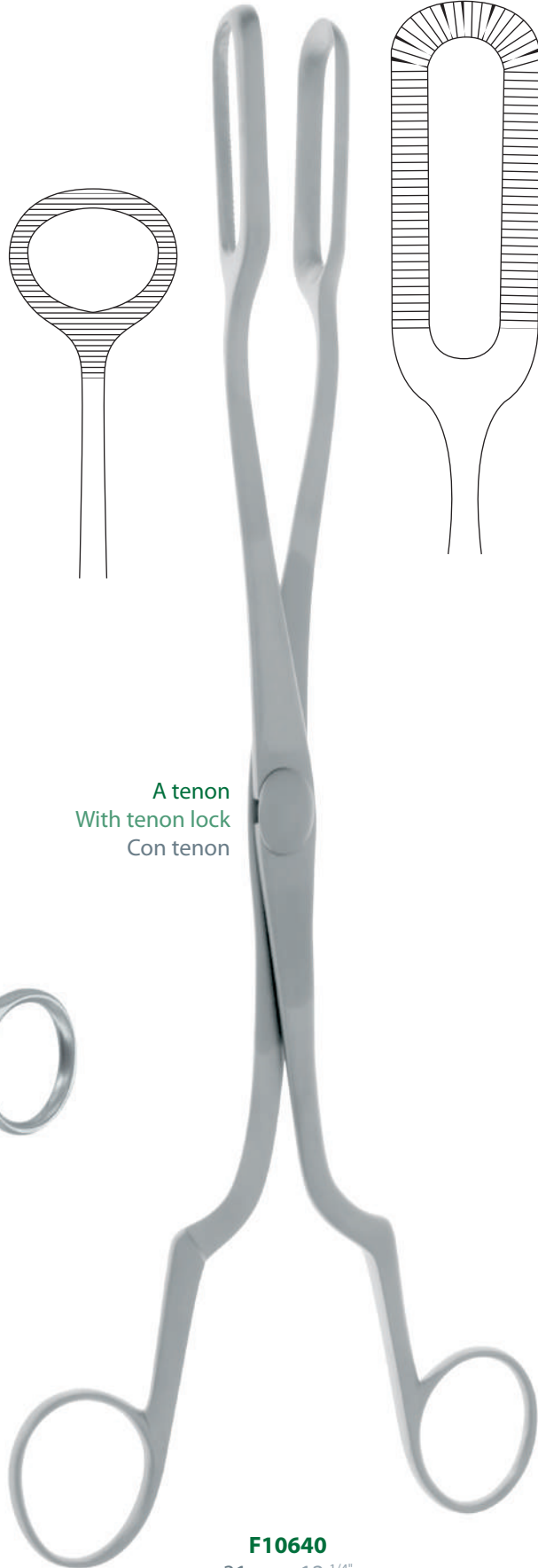

F10640
31 cm - 12 1/4"

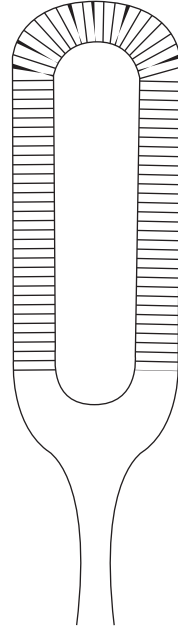

BONNAIRE



KELLY

HEYWOOD-SMITH

NOTO

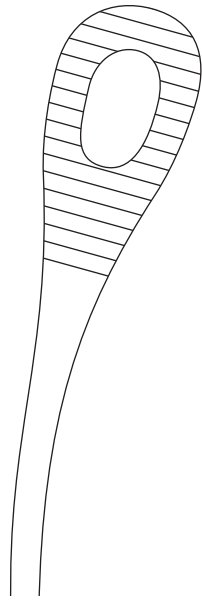

F106220
32 cm - 12 1/2"

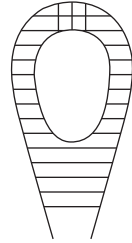

F106230
25 cm - 10"

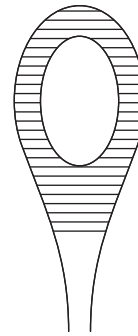

A vis
With screw
Con tornillo



F106240
27 cm - 10 1/2"

Pinces utérines - Uterines forceps - Pinzas uterinas

Avec embout de protection
With protective cap
Con tapa protectora

WINTER

A vis
With screw
Con tornillo

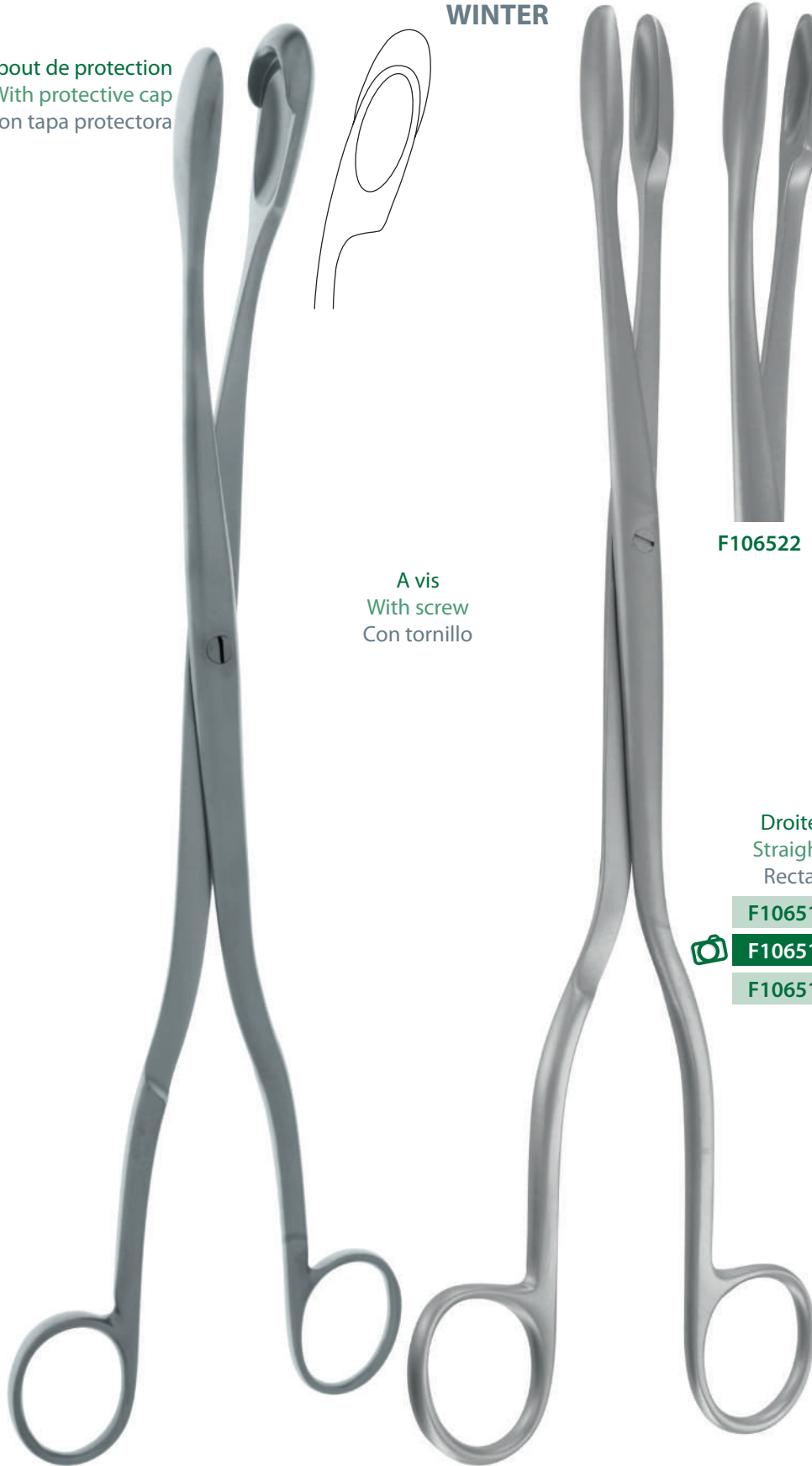

F10650
29 cm - 11 1/2"

F106512
29 cm - 11 1/2"



F106521



F106522



F106523

F106522

Droite
Straight
Recta

Courbe
Curved
Curva

F106511

9 mm

F106521



F106512

11 mm

F106522

F106513

14 mm

F106523

SAENGER

GREEN-ARMYTAGE

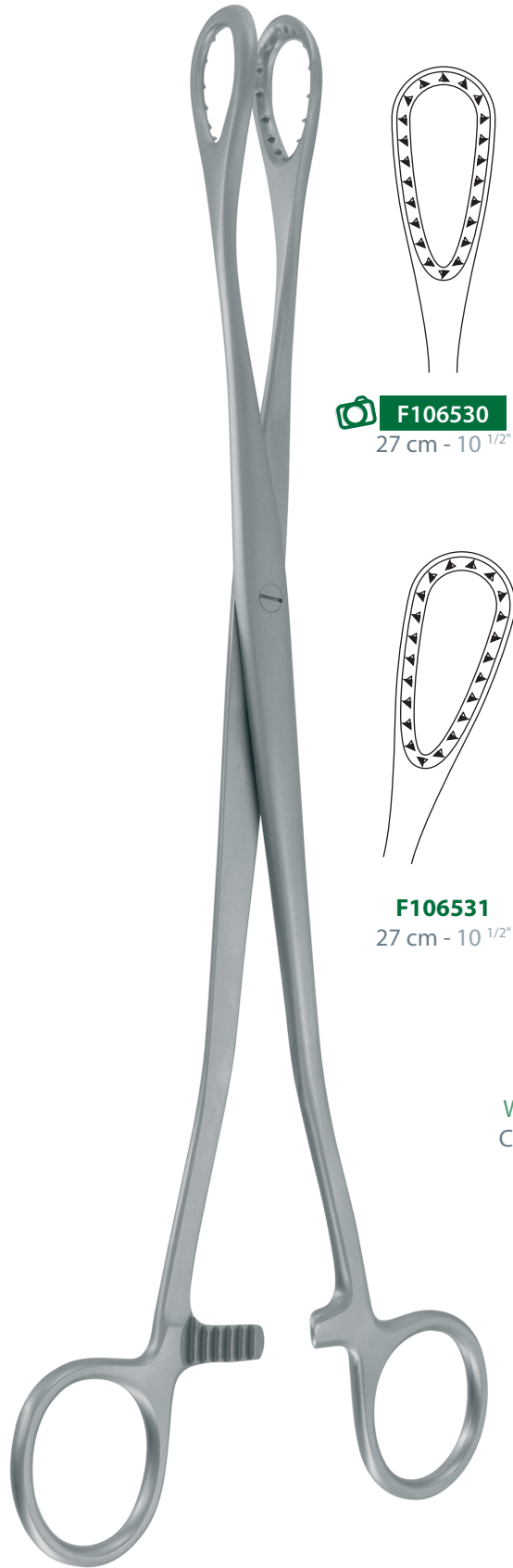

F106530
27 cm - 10 1/2"

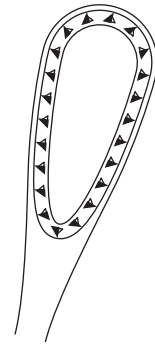

F106531
27 cm - 10 1/2"

A vis
With screw
Con tornillo

F106530
27 cm - 10 1/2"



F106540
21 cm - 8 1/4"

COLLIN

F16000	90 x 14 mm
F16010	90 x 16 mm
F16020	90 x 25 mm
F16030	90 x 30 mm
F16034	95 x 35 mm
F16038	105 x 30 mm
F16040	105 x 35 mm
F16050	105 x 38 mm
F16060	110 x 42 mm

Modèle lourd
Heavy model
Fuerte modelo

F17016	100 x 16 mm
F17025	100 x 25 mm
F17030	100 x 30 mm
F17035	100 x 35 mm
F17040	100 x 40 mm

Longues valves
Long blades
Valvulas largas

F17130	150 x 30 mm
F17135	150 x 35 mm
F17140	150 x 40 mm

Modèles avec tube d'aspiration
Models with aspiration tube
Modelos con tubo de aspiración

F18125	90 x 25 mm
F18130	90 x 30 mm
F18135	95 x 35 mm
F18230	105 x 30 mm
F18235	105 x 35 mm
F18240	110 x 40 mm

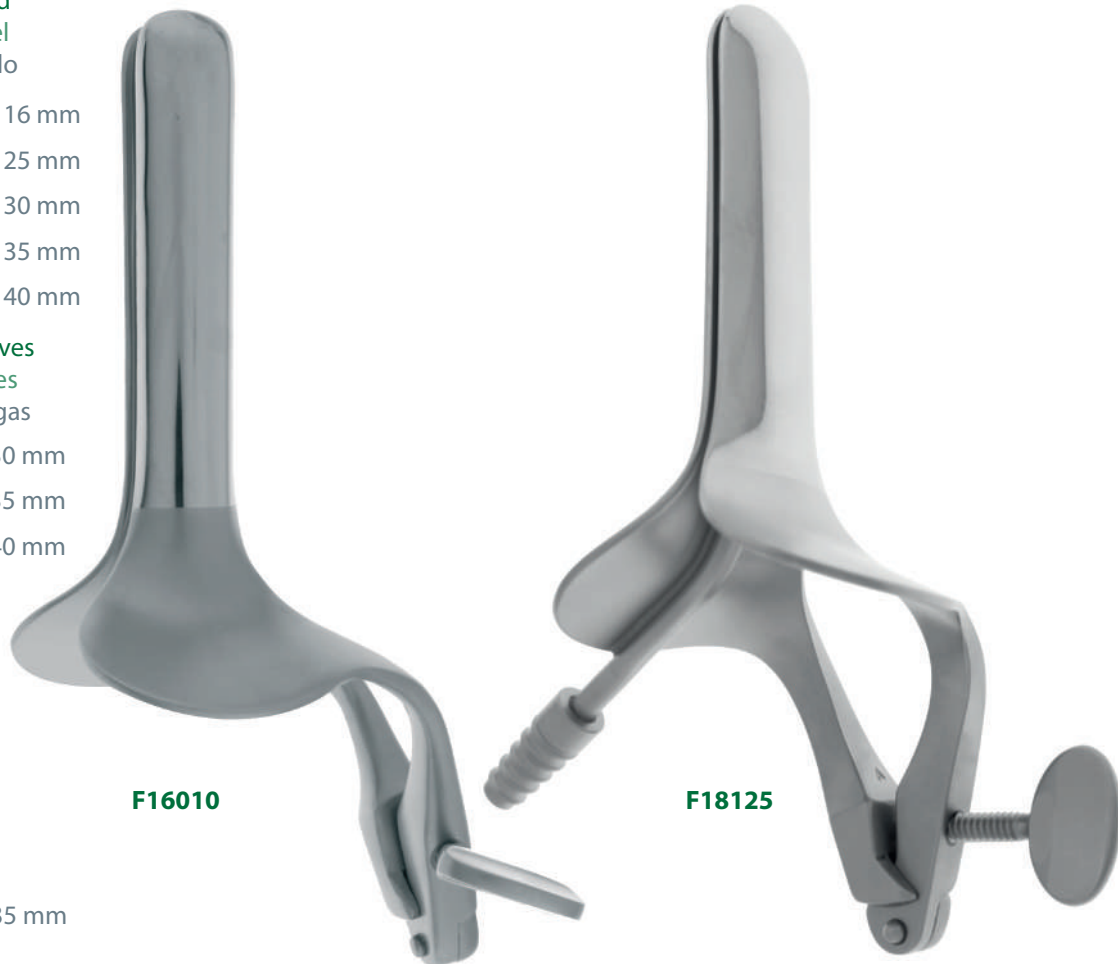

PALMER

F17165	65 x 35 mm
---------------	------------

JAYLE

	F17630	100 x 30 mm
	F17634	100 x 34 mm
	F17638	100 x 38 mm

Longues valves

Long blades



Valvulas largas

F17734	150 x 34 mm
F17738	150 x 38 mm



F17630

CUSCO

Pliant Pliable Plegable		Fixe Fixed Fijo	
F16070	100 x 16 mm	F16140	
F16080	100 x 25 mm	F16150	
F16090	100 x 28 mm	F16160 	
 F16100	100 x 30 mm	F16170	
F16110	100 x 35 mm	F16180	
F16120	100 x 37 mm	F16190	
F16130	100 x 40 mm	F16200	

SPÉCULUM POUR VIERGE VIRGIN SPECULA ESPÉCULO PARA VIRGEN

F16210	90 x 12 mm
F16220	90 x 14 mm
 F16230	90 x 16 mm
F16240	90 x 18 mm
F16250	90 x 20 mm



F16100

F16160

F16230

CUSCO

Spéculum pour vierge
Virgin specula
Espéculo para virgen

F163000 75 x 17 mm

F163001 75 x 32 mm

 **F163002** 85 x 35 mm

F163003 100 x 37 mm

GRAVE

F163011 75 x 20 mm

 **F163012** 95 x 30 mm

F163013 115 x 35 mm

Écarteur latéral
Lateral retractor
Retradores laterales



F163002



F163012



F163100

PEDERSON

F163031 75 x 13 mm

 F163032 100 x 22 mm

F163033 120 x 25 mm

SEYFFERT

F163021 100 x 17 mm

 F163022 110 x 33 mm

SEMM

F163041 90 x 14/18 mm

F163042 100 x 17/20 mm

 F163043 100 x 25/30 mm



F163032



F163022



F163043

KOGAN



F190010
24 cm - 9 1/2"



F190020
24 cm - 9 1/2"

DOYEN

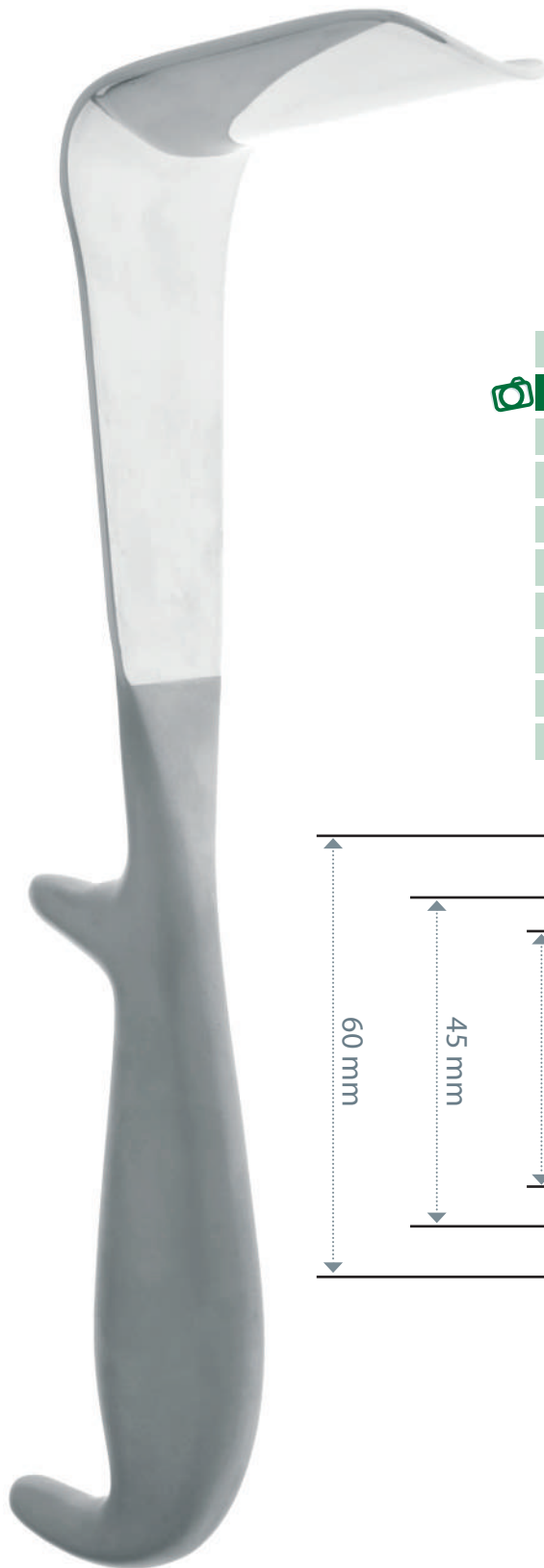

	Profondeur Depth Profundidad	Largeur Width Anchura
--	------------------------------------	-----------------------------

F250280	60 mm	35 mm
 F25030	60 mm	45 mm
F25060	60 mm	60 mm
F25035	90 mm	35 mm
F25040	90 mm	45 mm
F25070	90 mm	60 mm
F250450	120 mm	35 mm
F25050	120 mm	45 mm
F25080	120 mm	60 mm
F250810	160 mm	60 mm

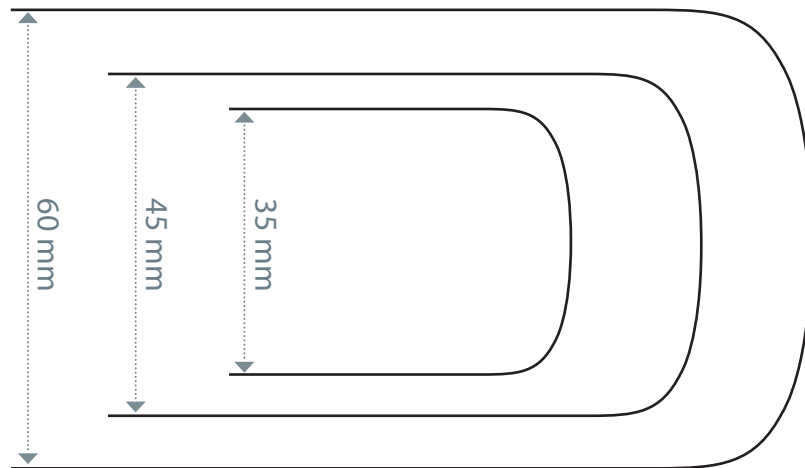

F25030
23 cm - 9"



POUR INTERVENTION PAR VOIE VAGINALE
FOR OPERATION THROUGH VAGINAL TRACT
PARA INTERVENCIÓN POR VÍA VAGINAL

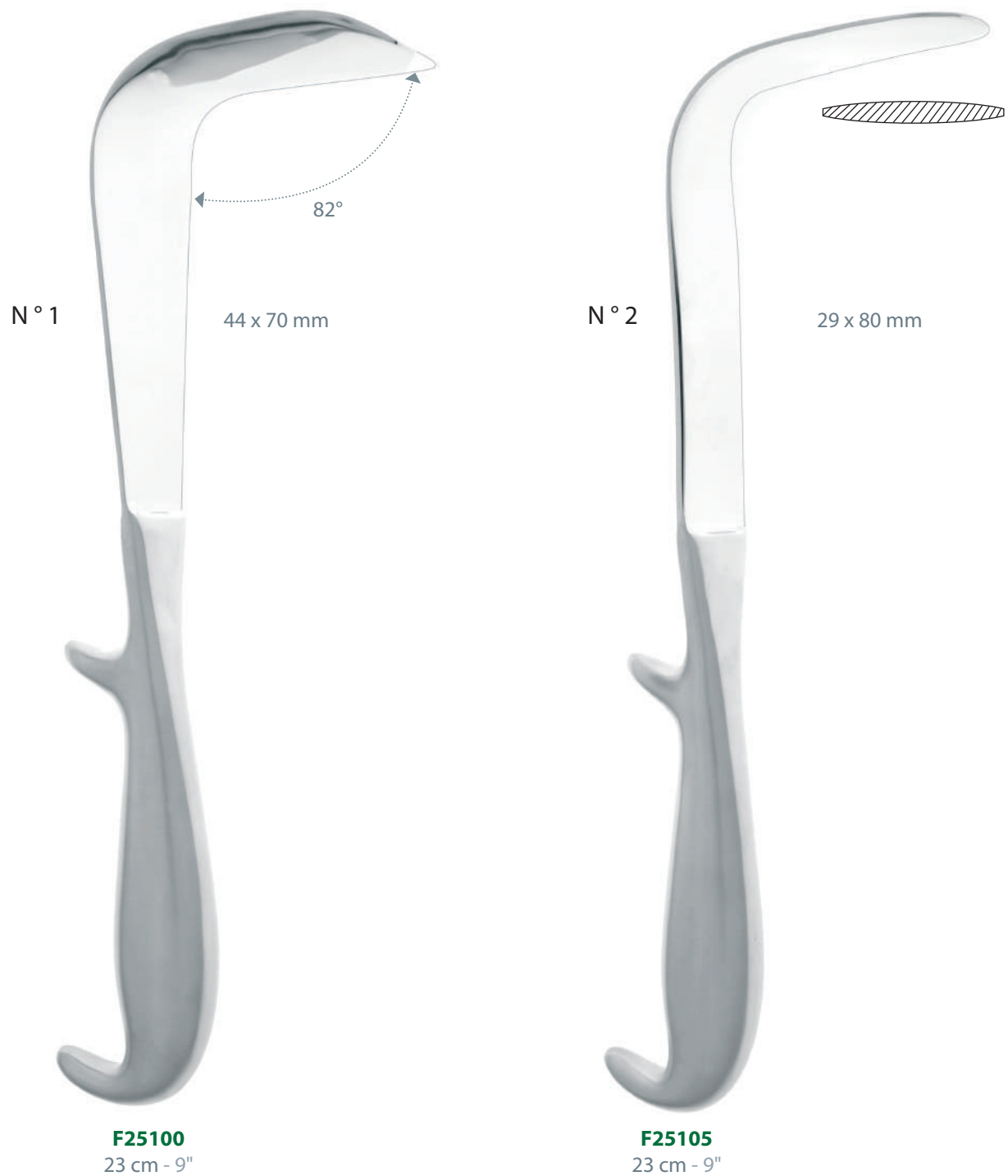

Valves vaginales - Vaginal blades - Valvas vaginales

POUR INTERVENTION PAR VOIE VAGINALE
FOR OPERATION THROUGH VAGINAL TRACT
PARA INTERVENCIÓN POR VÍA VAGINAL

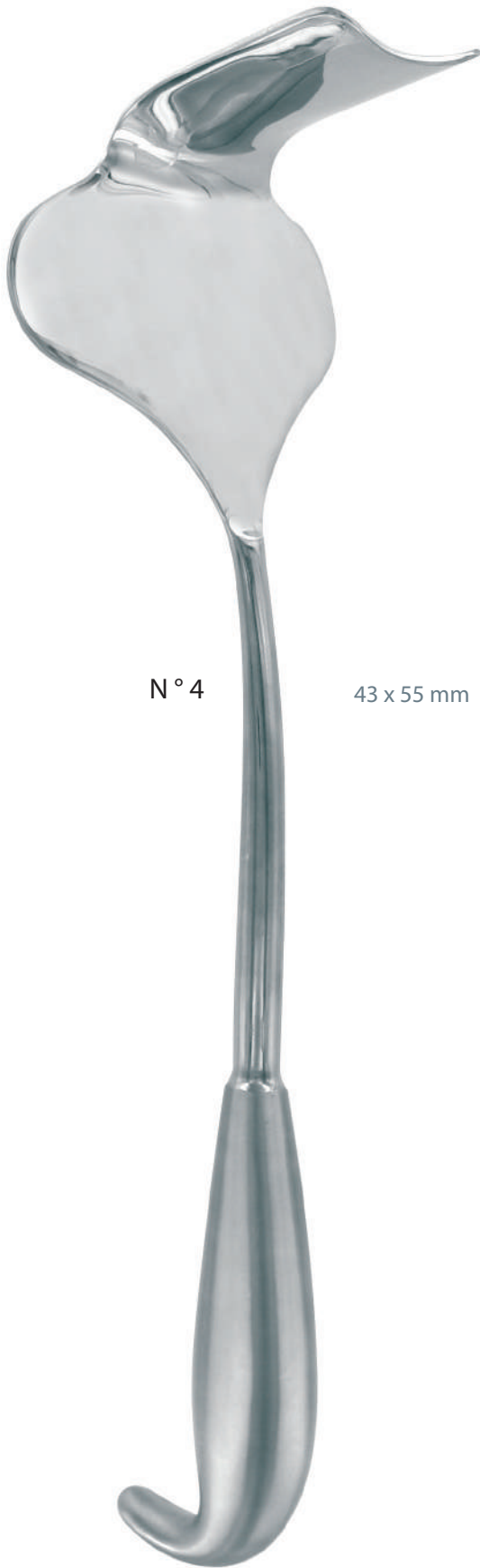

N° 4

43 x 55 mm

F25110

30 cm - 11 ³/₄"



N° 5

44 x 60 mm

F25115

23 cm - 9"

Valves vaginales - Vaginal blades - Valvas vaginales

Pour intervention par voie vaginale
For operation through vaginal tract
Para intervención por vía vaginal

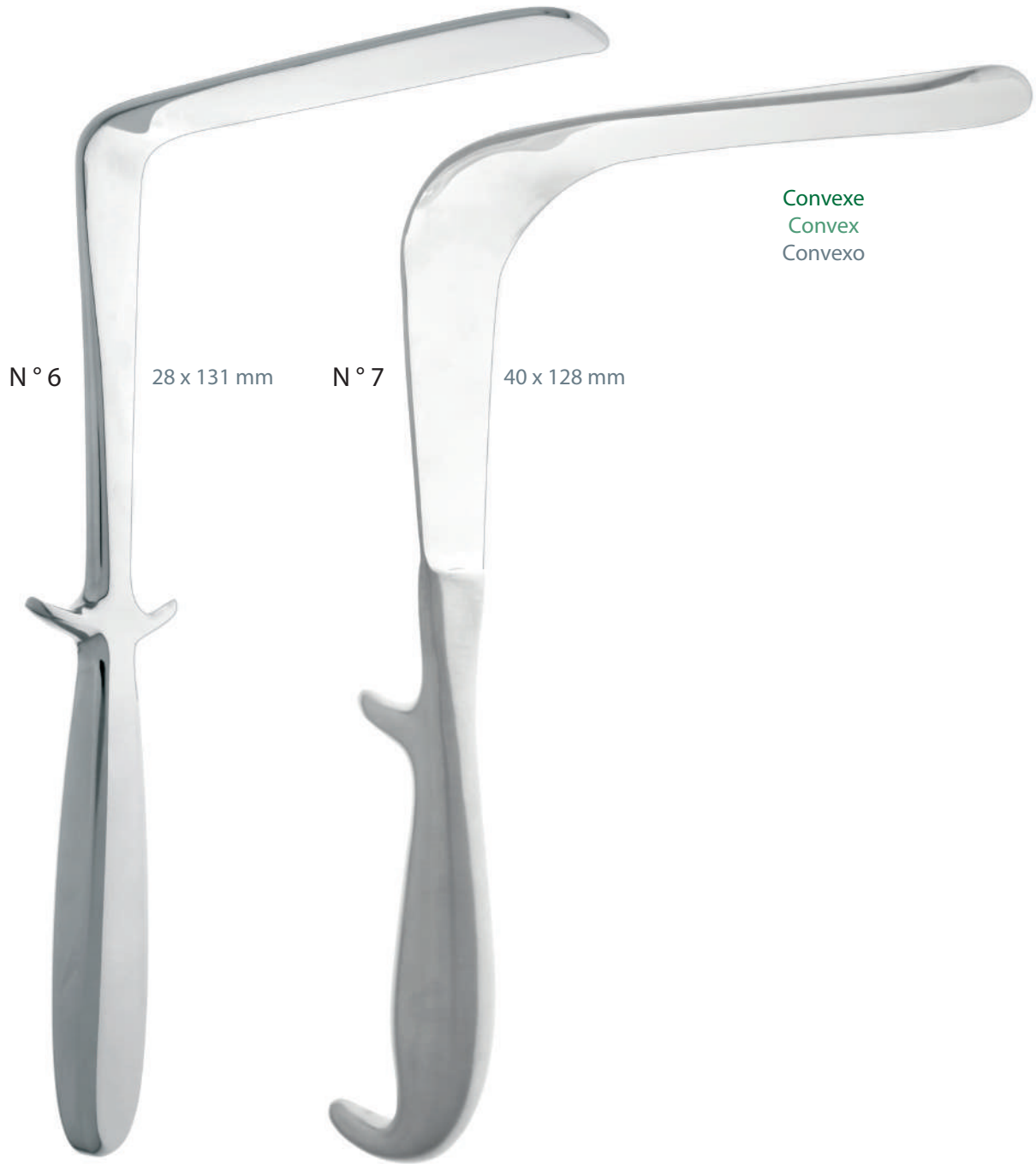

Convexe
Convex
Convexo

N° 6

28 x 131 mm

N° 7

40 x 128 mm

F25120

24 cm - 9 1/2"

F25125

23 cm - 9"

MANGIAGALLI

DOUGLAS



80 x 40 mm

F251280
19 cm - 7 1/2"



100 x 42 mm

F251281
19 cm - 7 1/2"



130 x 35 mm

F251290
18 cm - 7"

DARGENT



Baïonette
Bayonet
Bayoneta

F260010
38 cm - 15"

			Largueur Width Anchura	Longueur Length Largo
N° 1	38 cm - 15" 	F260010	40 mm	150 mm
N° 2	37 cm - 14 1/2"	F260020	48 mm	135 mm
N° 3	35 cm - 13 3/4"	F260030	50 mm	115 mm
N° 4	34 cm - 13 1/2"	F260040	40 mm	115 mm
N° 5	33 cm - 13"	F260050	38 mm	95 mm
N° 6	29 cm - 11 1/2"	F260060	32 mm	90 mm
N° 7	28 cm - 11"	F260070	28 mm	80 mm
N° 8	30 cm - 11 3/4"	F260080	32 mm	90 mm
N° 9	30 cm - 11 3/4"	F260090	30 mm	80 mm
N° 10	31 cm - 12 1/4"	F260100	30 mm	85 mm
N° 11	31 cm - 12 1/4"	F260110	22 mm	77 mm
N° 12	26 cm - 10 1/4"	F260120	15 mm	70 mm

LANDANGER

Valves vaginales - Vaginal blades - Valvas vaginales

LANDAU

		Largeur Width Anchura	Longueur Length Largo
29 cm - 11 1/2"	 F251610	28 mm	100 mm
29 cm - 11 1/2"	F251615	38 mm	100 mm



F251610
29 cm - 11 1/2"

BREISKY

		Largeur Width Anchura	Longueur Length Largo
27 cm - 10 3/4"	F251640	15 mm	70 mm
27,5 cm - 10 4/5"	F251720	28 mm	80 mm
28 cm - 11"	F251770	32 mm	90 mm
29 cm - 11 1/2"	F251645	20 mm	100 mm
29 cm - 11 1/2"	F251690	25 mm	100 mm
29 cm - 11 1/2"	F251740	30 mm	100 mm
29 cm - 11 1/2"	F251790	35 mm	100 mm
29 cm - 11 1/2"	F251840	40 mm	100 mm
32 cm - 12 1/2"	F25165	20 mm	130 mm
32 cm - 12 1/2"	F25170	25 mm	130 mm
32 cm - 12 1/2"	F25175	30 mm	130 mm
32 cm - 12 1/2"	F25180	35 mm	130 mm
32 cm - 12 1/2"	F25185	40 mm	130 mm
34 cm - 13 1/2"	F251900	40 mm	150 mm
37 cm - 14 1/2"	 F251950	40 mm	180 mm



F251950
37 cm - 14 1/2"

JACKSON



16 cm - 6 1/4"



F251620

Longueur Length Largo	Largeur Width Anchura
75 mm	40 mm
90 mm	40 mm
100 mm	40 mm

F251621

90 mm 40 mm

F251622

100 mm 40 mm

F251620

KRISTELLER

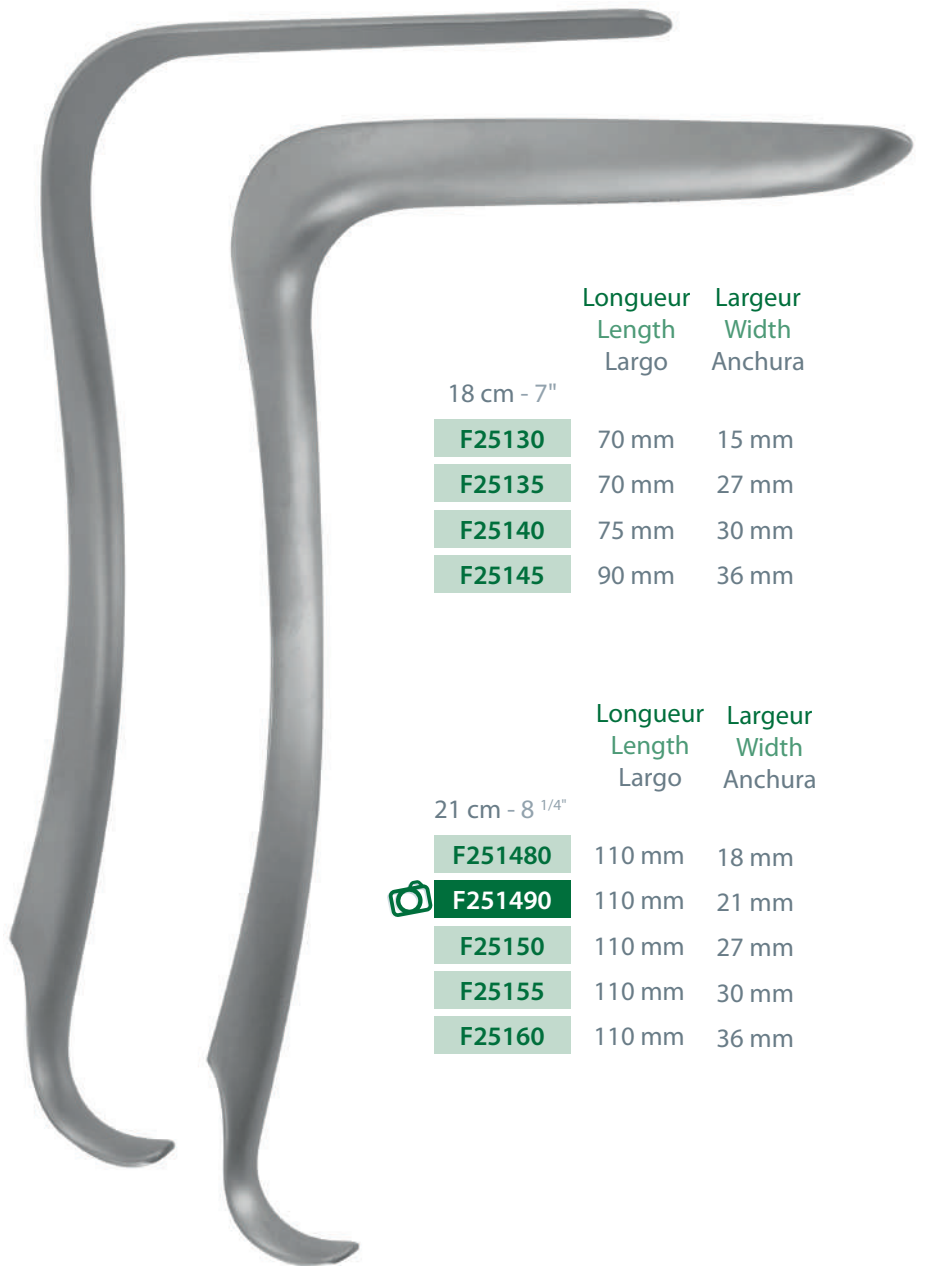

18 cm - 7"

F25130

Longueur Length Largo	Largeur Width Anchura
70 mm	15 mm
70 mm	27 mm
75 mm	30 mm
90 mm	36 mm

F25135

70 mm 27 mm

F25140

75 mm 30 mm

F25145

90 mm 36 mm

21 cm - 8 1/4"

F251480

Longueur Length Largo	Largeur Width Anchura
110 mm	18 mm
110 mm	21 mm
110 mm	27 mm
110 mm	30 mm
110 mm	36 mm



F251490

110 mm 21 mm

F25150

110 mm 27 mm

F25155

110 mm 30 mm

F25160

110 mm 36 mm

F251490

VALVE + SPECULUM
BLADE + SPECULUM
VALVULA + SPECULUM

SIMS

A l'unité - Per unit - La unidad

	Longueur Length Largo	Largeur Width Anchura	Longueur Length Largo	Largeur Width Anchura		Longueur Length Largo	Largeur Width Anchura	
	A		B					
F251631	60 mm	25 mm	60 mm	30 mm		F251635	63 mm	32 mm
F251632	70 mm	30 mm	70 mm	35 mm		F251636	76 mm	32 mm
F251633	80 mm	35 mm	80 mm	40 mm		F251637	89 mm	38 mm

Jeux de 3 - Set of 3 - Juego de 3

 **F251630**



F251630
18 cm - 7"



F251635
17 cm - 6 ³/₄"

DOYEN

F251270 60 x 30 mm

 F251271 70 x 30 mm

F251272 80 x 30 mm

MATHIEU

Valve
Blade
Valva

Spéculum
Specula
Espéculo



F251271
25 cm - 10"

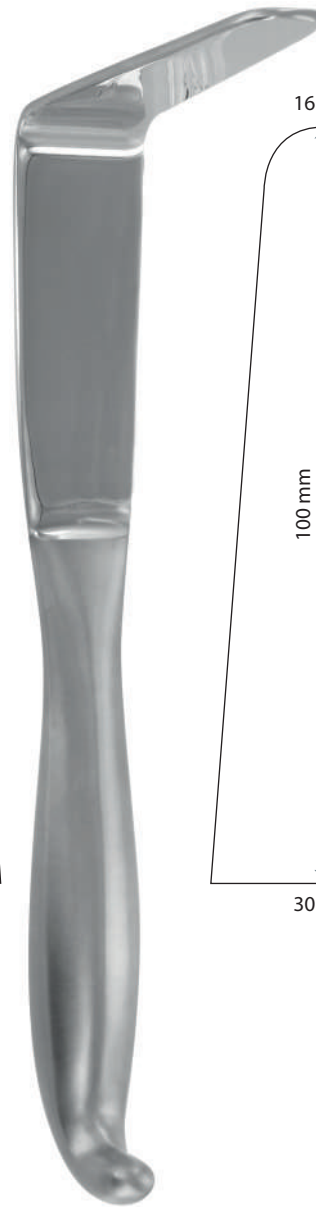
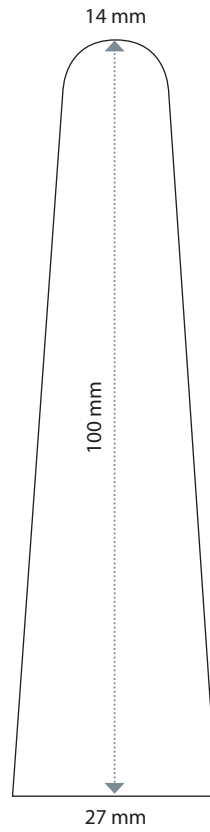

F251275
20 cm - 8"

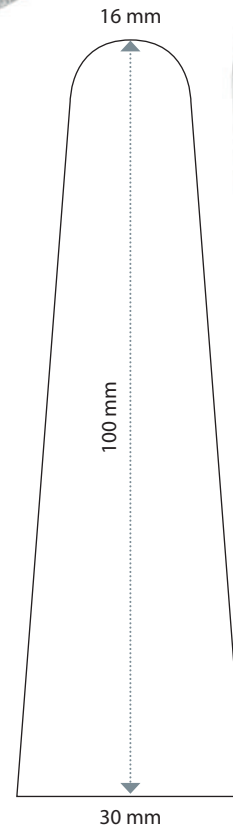

F251276
20 cm - 8"

ST MARKS



180 x 60 mm

180 x 60 mm

F251261

32,5 cm - 12 ³/₄"



130 x 60 mm

F251260

29 cm - 11 ¹/₂"

F251262

33 cm - 13"



JAYLE

Valve + Poids Blade + Weight Valva + Peso	Largeur Width Anchura	Longueur Length Largo
F25010	40 mm	60 mm
F25020	40 mm	90 mm



Poids seul (1000 g)
Weight only (2,2 pounds)
Peso sólo (1000 g)

Valve seule Blade only Valva sólo	Longueur Length Largo
 F250110	60 mm
F250210	90 mm



F250110
18 cm - 7"

F25025
16 cm - 6 1/4"



AUVARD

F250265 70 x 38 mm

 **F250266** 105 x 45 mm



Poids fixe
Fixed weight
Peso fijo

F250266
23,5 cm - 9¹/₄"



 **F250260** 80 x 38 mm

F250261 105 x 42 mm

Poids démontable
Removable weight
Peso desmontable

F250260
23 cm - 9"

SCHERBAK



F250277 55 x 40/60 mm



F250278 70 x 45/70 mm



Poids seul
Weight only
Peso solo

 **F250272** 400 Gr

F250273 800 Gr



Manche seul
Handle only
Mango solo
20 cm - 8" **F250271**



F250274 80 x 30 mm



F250275 85 x 35 mm



F250276 90 x 40 mm



F250271



F250272



F250274



F250275



F250276



F250277



F250278

Complet - Complete - Completo **F250270** 

LANDANGER

Amnioscopes - Amnioscopes - Amnioscopo

Complet avec mandrin
Complete with mandril
Completo con mandrino

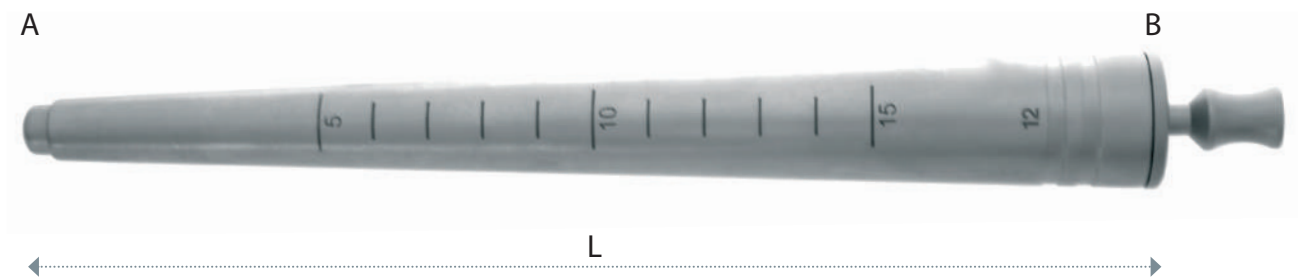

	Ø A	Ø B	L
 F15370	12 mm	24 mm	200 mm
F15380	16 mm	24 mm	200 mm
F15390	20 mm	24 mm	200 mm

Pince hystérolable - Uterine elevating forceps - Pinzas para coger el útero

COLLIN

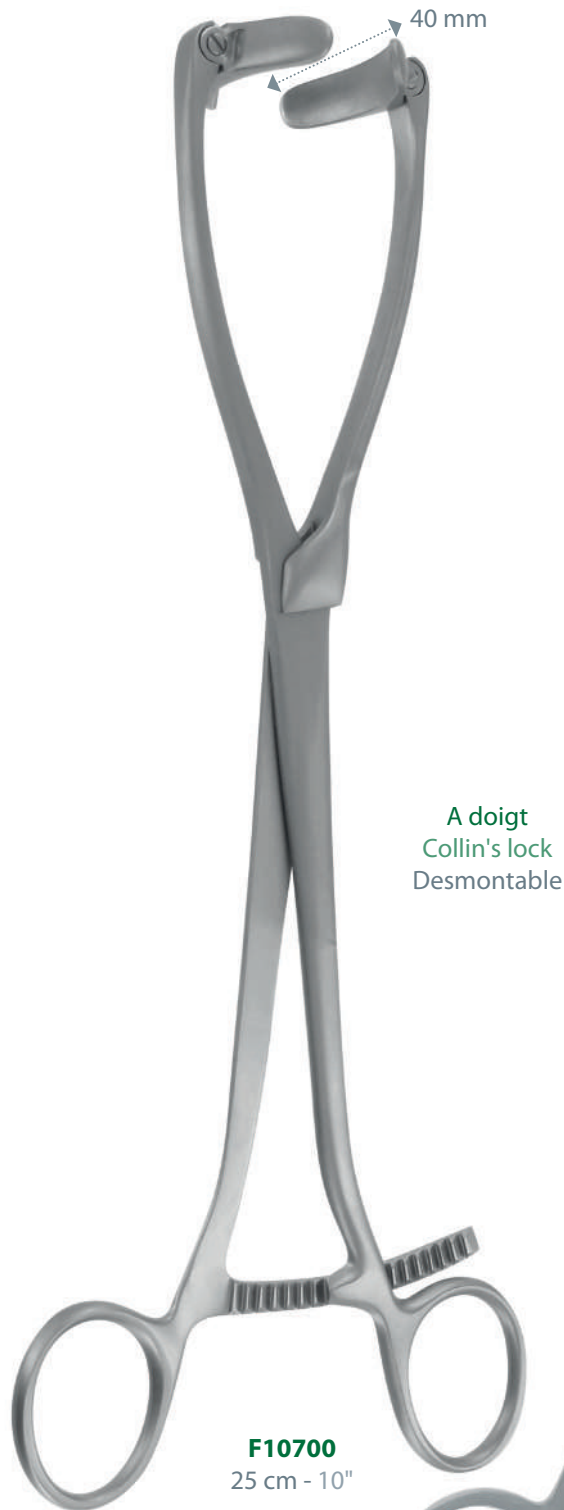

DARTIGUES

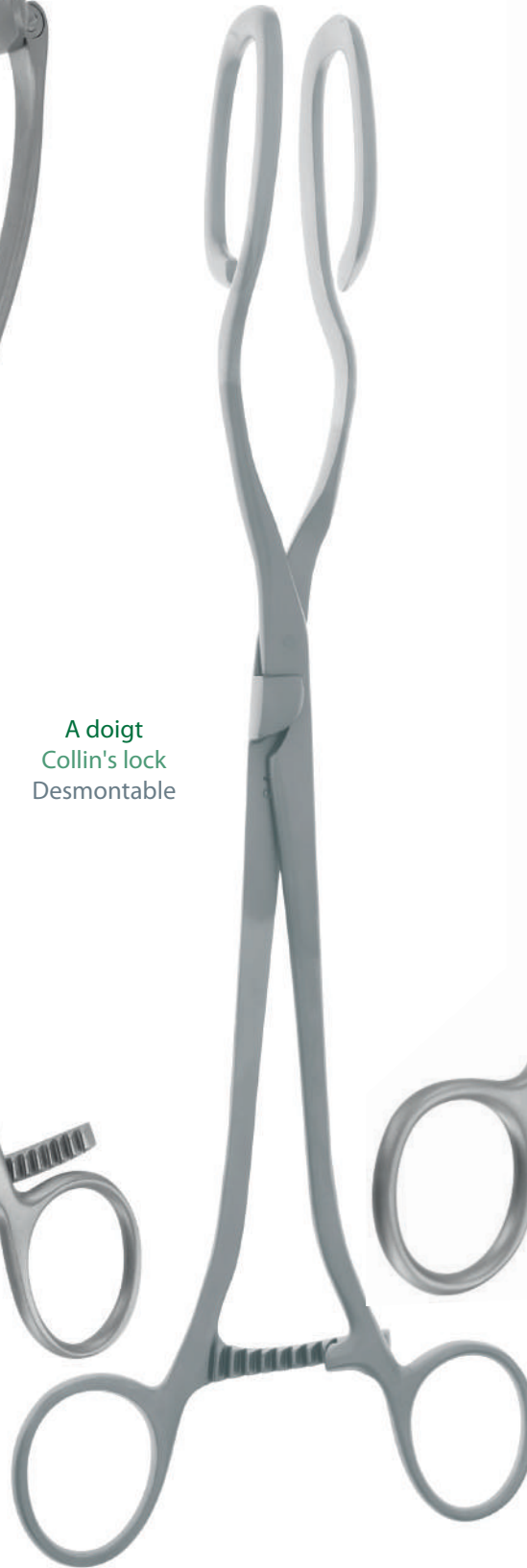

SOMMER



TARNIER

Complet
Complete
Completo

F10710
40 cm - 15 ³/₄"

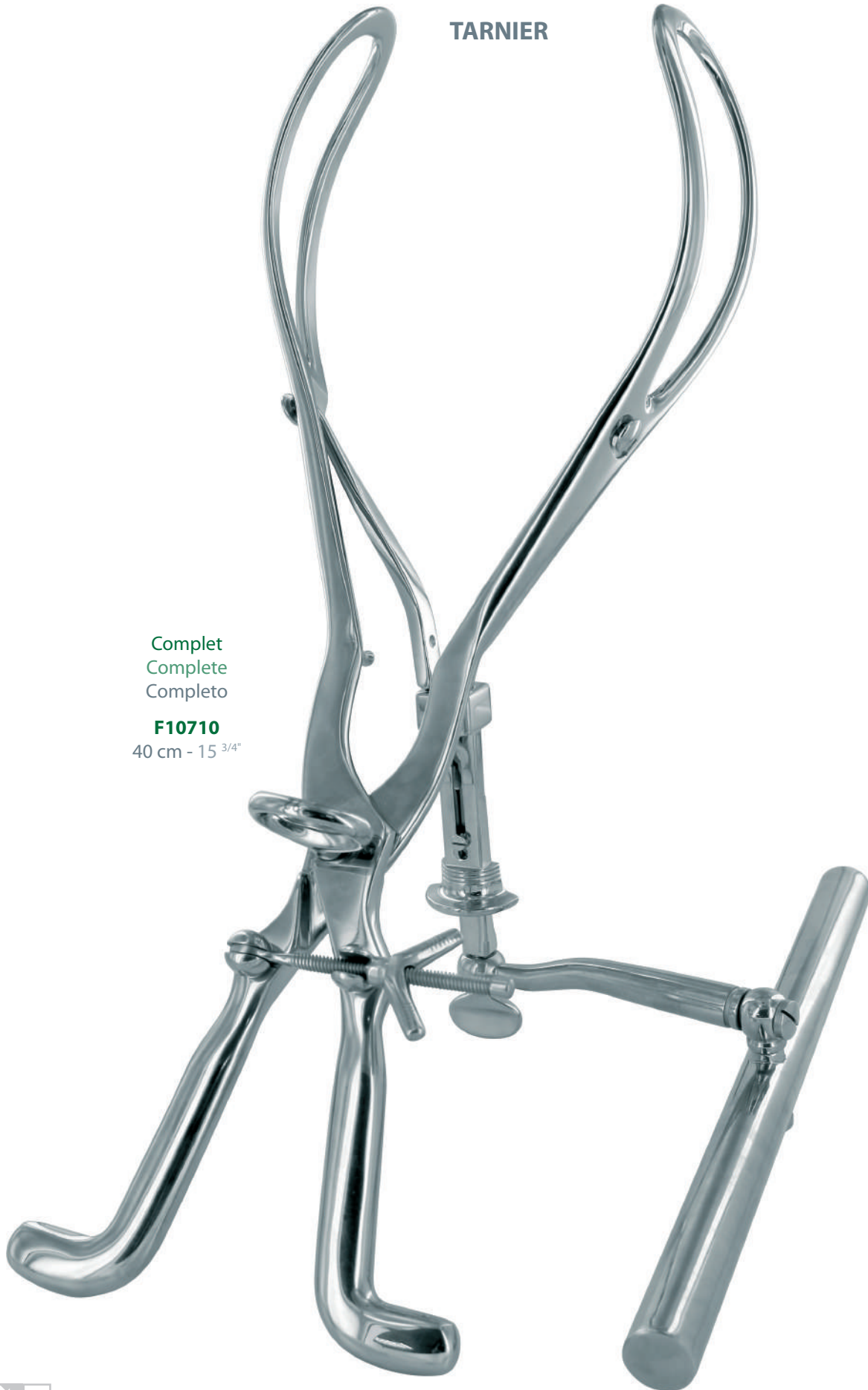

DEMELIN-SUZOR

Système de serrage seul
Screw system only
Sistema de apreta solo



F107210

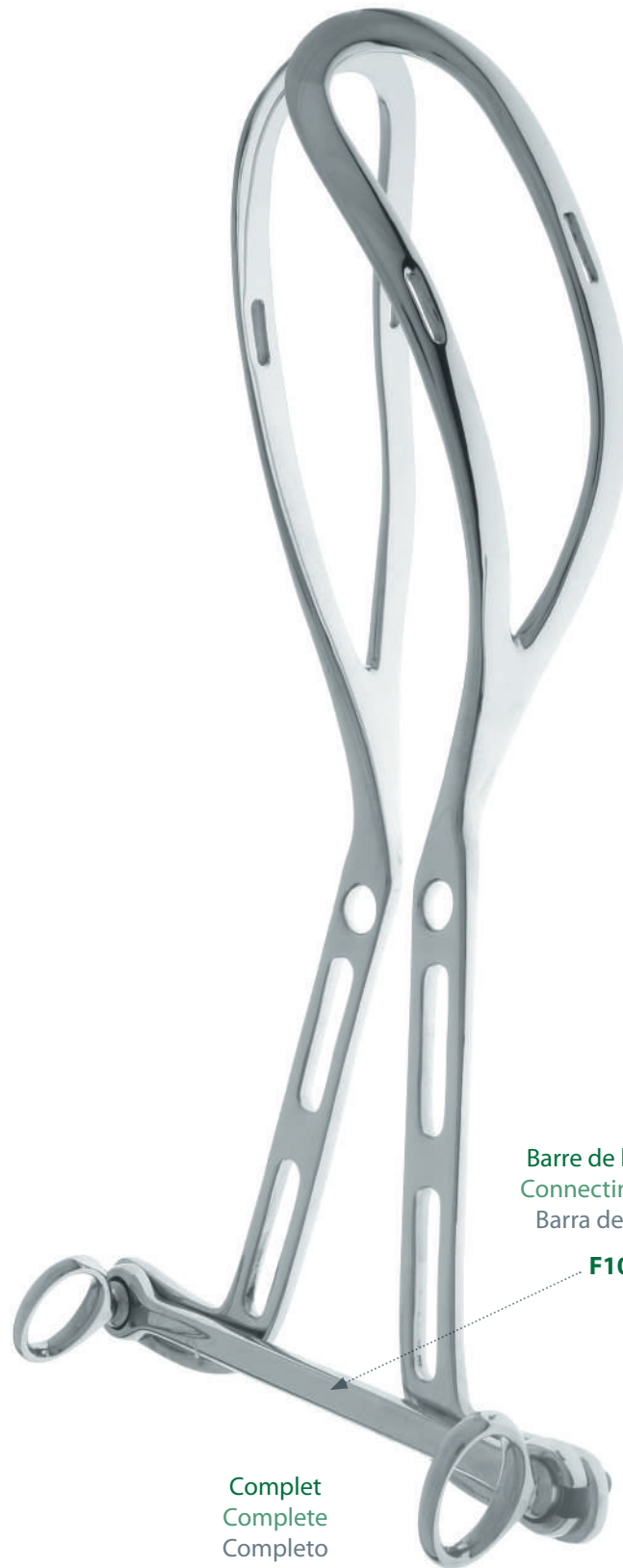

Barre de liaison seule
Connecting plate only
Barra de unión sólo

F107205

Complet
Complete
Completo

F10720
32 cm - 12 1/2"

PAJOT



F10730
36 cm - 14 1/4"

MC LEAN



F107870
36 cm - 14 1/4"

KIELAND



F10732
41 cm - 16 1/4"

NAGELE

Spatules obstétricales (paire)
 Obstetrical spatulas (pair)
 Espatulas obstetricas (par)

36 cm - 14 1/4"

F10736



39 cm - 15 1/4"

F10735



F107330

40 cm - 15 3/4"



F10736

36 cm - 14 1/4"



WRIGLEY

SIMPSON



F107220
28 cm - 11"



F107230
23 cm - 9"



F107240
30 cm - 12"

LEVRET



F107250
41 cm - 16 1/4"

SIMPSON BRAUN



F107260
36 cm - 14"

PIPER



F107270
44 cm - 17 1/4"

TEISSIER

Les 2 spatules sans tracteur
 The 2 spatulas without traction handle
 Las 2 espatulas sin tractor



F10737
 31 cm - 12 1/4"

Tracteur seul
 Traction handle only
 Tractor sólo



F10738

SIMPSON LUIKART



F107340
 36 cm - 14"

NOTTER



Perce membrane (amniotome)
Membrane punch
Perforador para la membrana

F107900
22 cm - 8 3/4"



Pince à couper les clamps
Forceps to cut the clamps
Pinzas para cortar los clamps

F10800
22 cm - 8 3/4"

BAR



F10740
8,5 cm - 3 1/3"



F10755
15 cm - 6"

Ventouse obstétricale - Obstetric vacuum cup - Ventosa obstétrica

Ventouse
Suction cup
Ventosa

	Ø
 F315005	30 mm
F315006	40 mm
F315007	50 mm

Diaphragme
Diaphragm
Diafragma

	Ø
 F315015	40 mm
F315016	50 mm
F315017	60 mm

Poignée de traction
Traction handle
Puñado de tracción

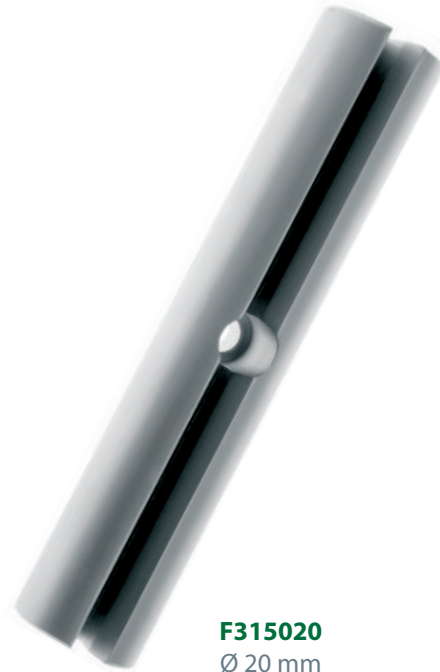

F315020
Ø 20 mm
10 cm - 4"



F315005



F315015

Lac de traction (nylon)
Vessel of traction (nylon)
Bramante de tracción (nylon)

F315021

6 brins de 1 m
6 wires of 39 1/4"
6 hilos de 1 m



3 tubes silicone
3 silicon tubs
3 tubos de silicona

 **F315022**

2 m - Ø 3 x 7 mm

Rouleau tube silicone
Roll tub silicon
Rollo tubo silicona

F315122

25 m - Ø 3 x 7 mm



J. L. FAURE

SHUBERT



A vis
With screw
Con tornillo

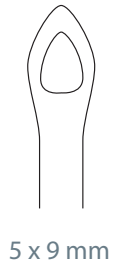

5 x 9 mm

F20160
25 cm - 10"



4,5 x 8 mm

F20165
26 cm - 10 1/4"

LANDANGER

Pinces à biopsie - Biopsy forceps - Pinzas para biopsia

VAN DOREN

SCHUMACHER

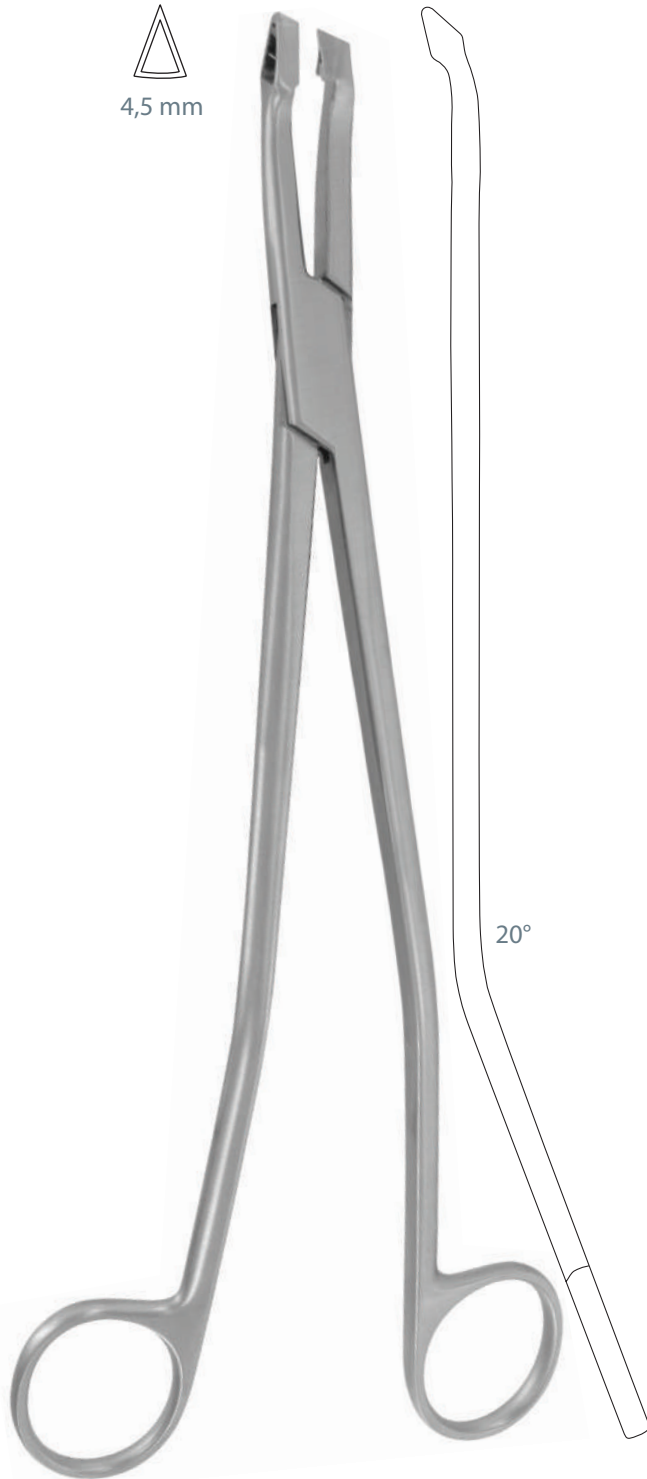
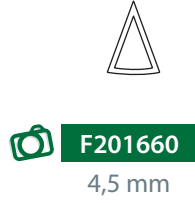

F201655
24 cm - 9 1/2"

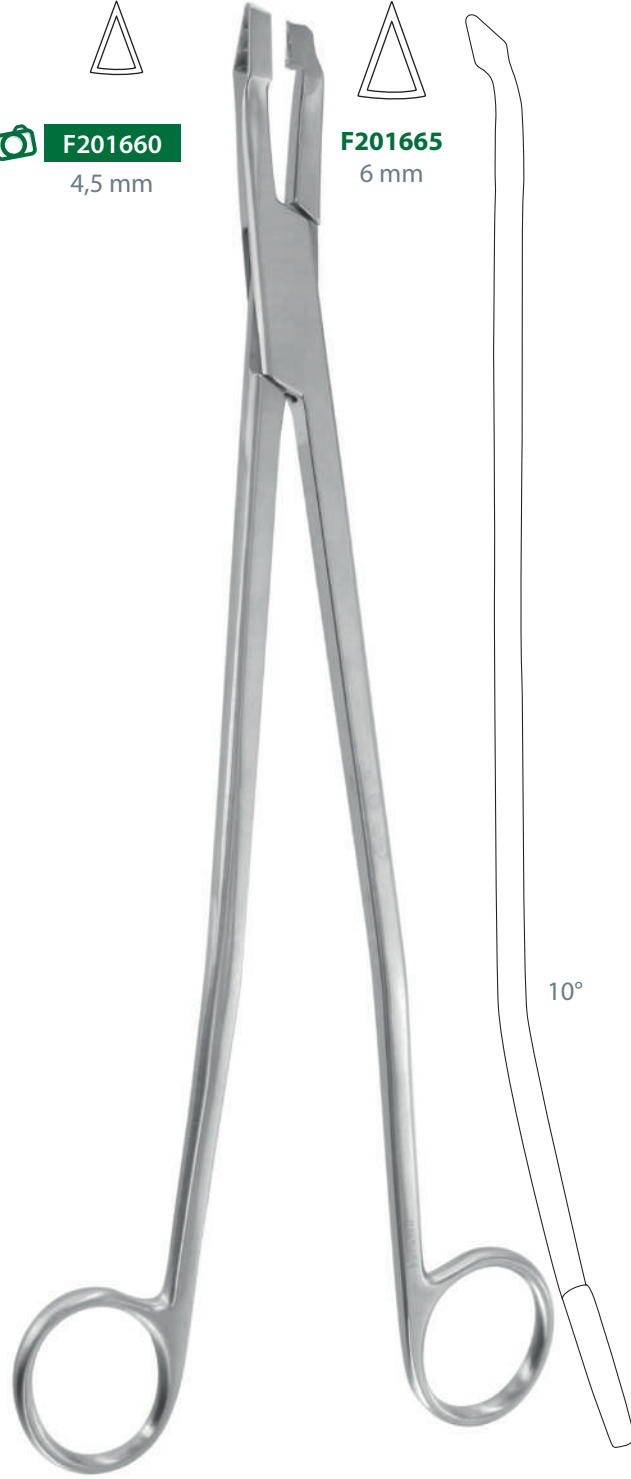

F201660
24 cm - 9 1/2"



LANDANGER

Pinces à biopsie - Biopsy forceps - Pinzas para biopsia

LANDANGER



TISCHLER-MORGAN



BABY-TISCHLER (MINI-TOWNSEND)

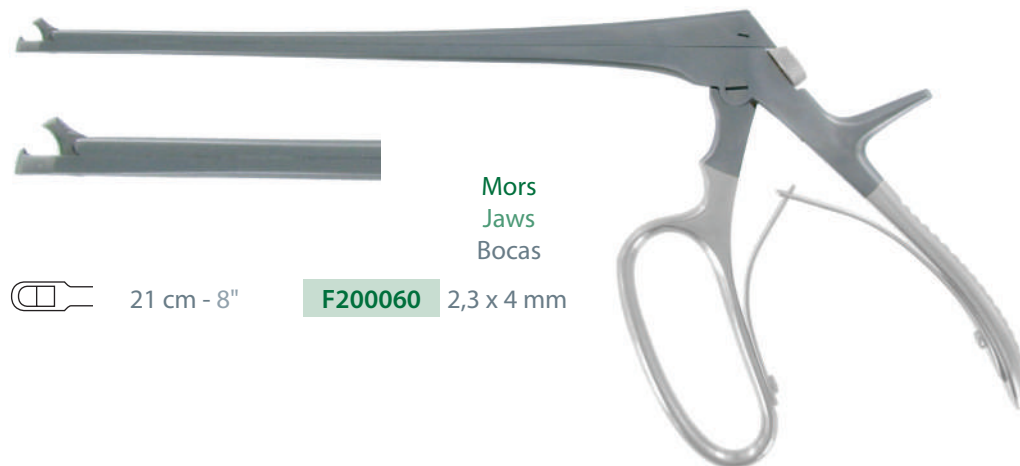

LANDANGER

Pinces à biopsie - Biopsy forceps - Pinzas para biopsia

DOUAY



20 cm - 8"  **F20010** 4 x 10 mm
25 cm - 10" **F20020** 4 x 10 mm
30 cm - 11 ³/₄" **F20030** 4 x 10 mm

BERGER

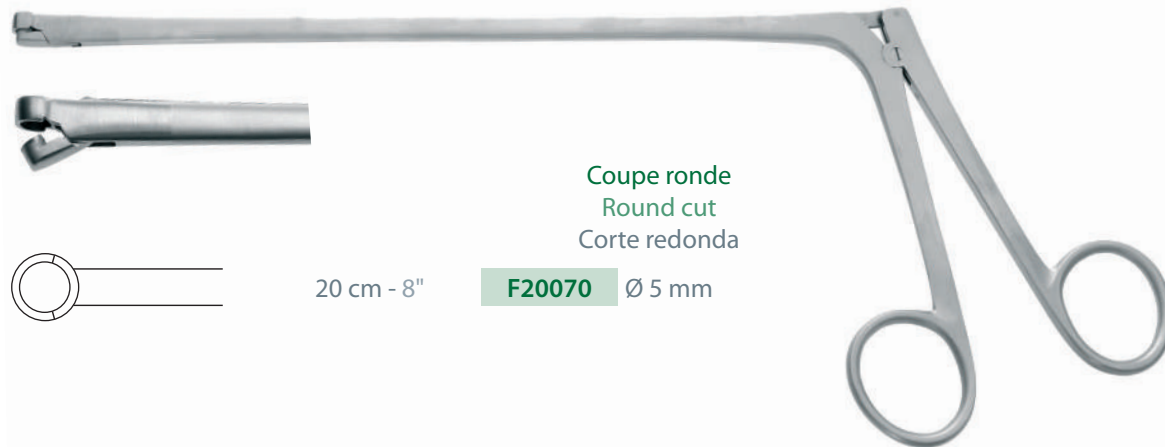

20 cm - 8" **F20070** Ø 5 mm

SCHUMAKER

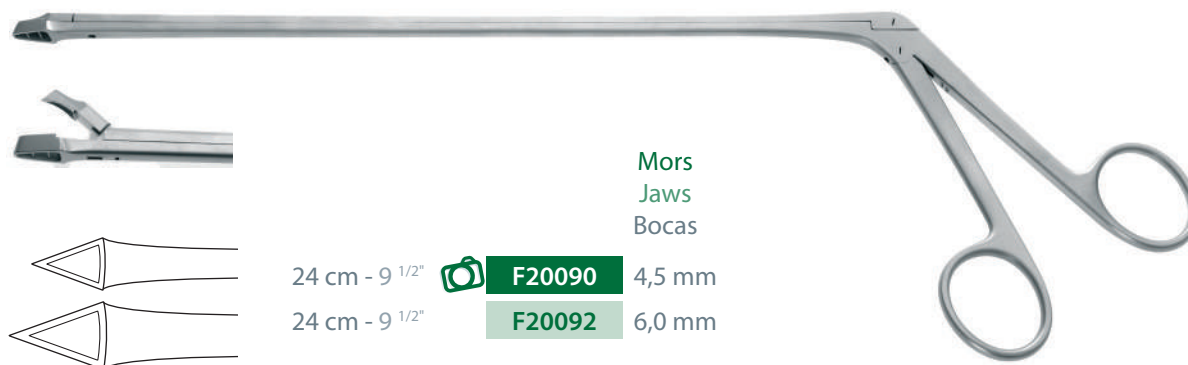

24 cm - 9 ¹/₂"  **F20090** 4,5 mm
24 cm - 9 ¹/₂" **F20092** 6,0 mm

PATTERSON

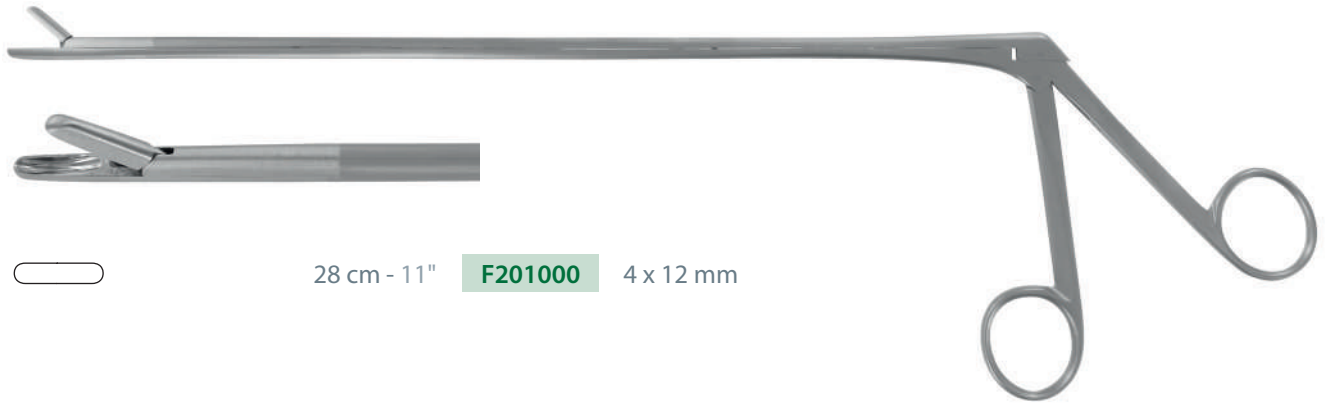

KEVORKIAN



EPPENDORF

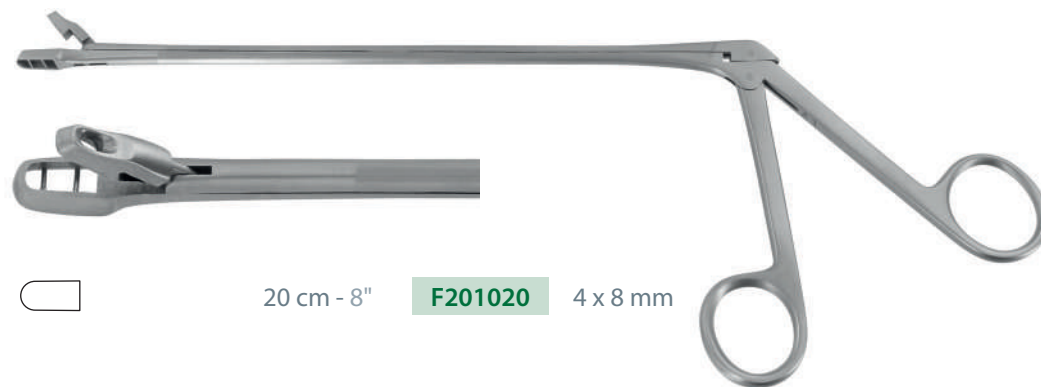

TOWNSEND

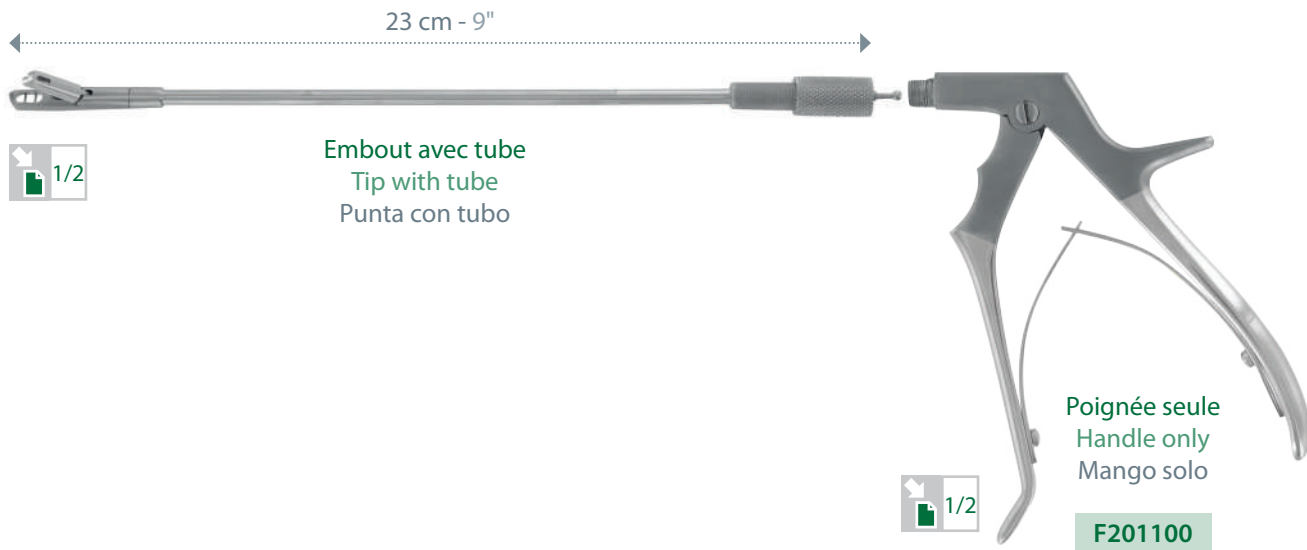

TISCHLER



KEVORKIAN



MINI TOWNSEND



GOURDET

Mousse
Blunt
Roma



F30180
26 cm - 10 1/4"

F30170

4 mm



F30180

6 mm



F30190

8 mm



F30200

10 mm



F30210

12 mm

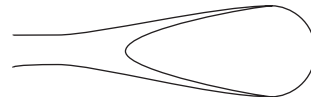

F30220

14 mm

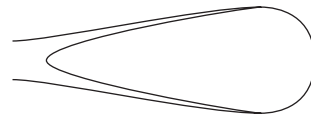

F30230

16 mm

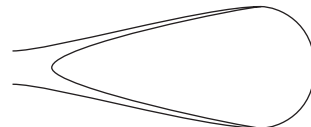

WALLICH

Mousse
Blunt
Roma



35 cm - 13 3/4"  **F30245**

12 mm

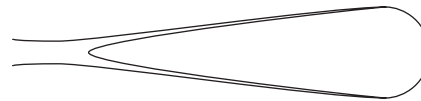

35 cm - 13 3/4" **F30250**

40 cm - 15 3/4" **F30280**

14 mm

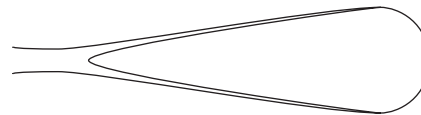

35 cm - 13 3/4" **F30260**

40 cm - 15 3/4" **F30290**

17 mm

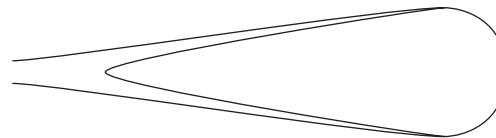

35 cm - 13 3/4" **F30270**

40 cm - 15 3/4" **F30300**

20 mm

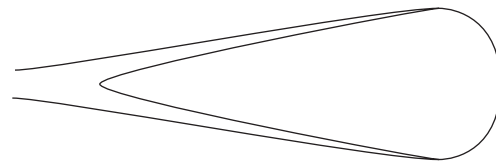

F30245
35 cm - 13 3/4"



SIMON

Tranchante
Sharp
Cortante

Double courbure
Double curvature
Doble curvatura



F30010
27 cm - 10 ³/₄"



F30010

4 mm



F30015

6 mm

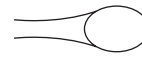

F30020

8 mm

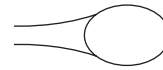

F30030

10 mm

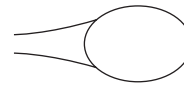

F30040

12 mm

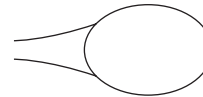

F30050

14 mm

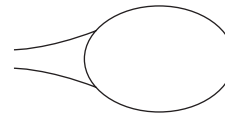

F30060

16 mm

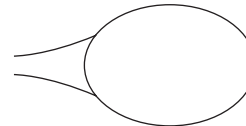

F30070

18 mm

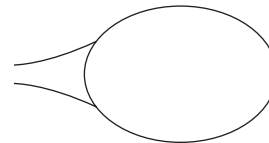

VOLKMANN

Tranchante
Sharp
Cortante



F30340
28 cm - 11"



F30340

3 mm

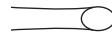

F30350

6 mm

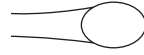

F30360

8 mm

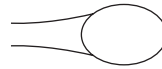

F30370

10 mm

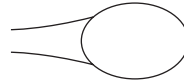

F30380

12 mm

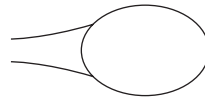

F30390

14 mm

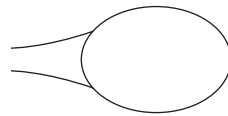

SCHRÖDER

Tranchante
Sharp
Cortante



F303913
30 cm - 12"

SIMON

Tranchante
Sharp
Cortante



F303922
25 cm - 10"

F303911

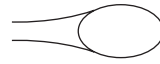

N° 1 - 7,0 mm

F303921

F303912

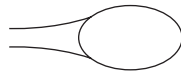

N° 2 - 8,5 mm

 **F303922**

 **F303913**

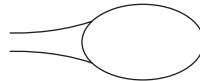

N° 3 - 10,0 mm

F303923

F303914

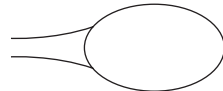

N° 4 - 11,5 mm

F303924

F303915

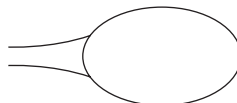

N° 5 - 13,0 mm

F303925

F303916

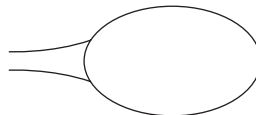

N° 6 - 14,5 mm

F303926

SIMS



F30130
28 cm - 11"

Tranchante Sharp Cortante	Mousse Blunt Roma		
F30080	F300801	3 mm	
F30090	F300901	4 mm	
F30100	F301001	5 mm	
F30110	F301101	6 mm	
F30120	F301201	8 mm	
 F30130	F301301	10 mm	
F30140	F301401	12 mm	
F30150	F301501	14 mm	
F30160	F301601	16 mm	

RECAMIER

Tranchante Sharp Cortante	Mousse Blunt Roma
---------------------------------	-------------------------

F30311	F30332	
		N° 00 - 5 mm

F30312	F30333	
		N° 01 - 7 mm

F30313	F30334	
		N° 03 - 9 mm

F30314	F30335	
		N° 05 - 12 mm

F30316	F30336	
		N° 06 - 14 mm

F30317	F30337	
		N° 08 - 16 mm

F30319	F30338	
		N° 09 - 19 mm

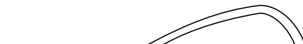
F303200	F303382	
		N°11 - 21 mm

F303210	F303383	
		N° 12 - 23 mm

Tranchante Sharp Cortante	Mousse Blunt Roma
---------------------------------	-------------------------

F303220	F303385
----------------	----------------

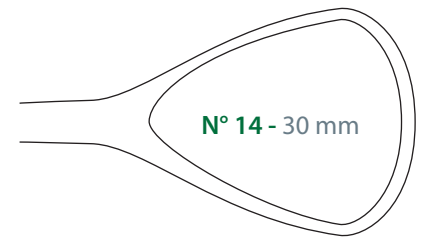

F303230	F303386
----------------	----------------

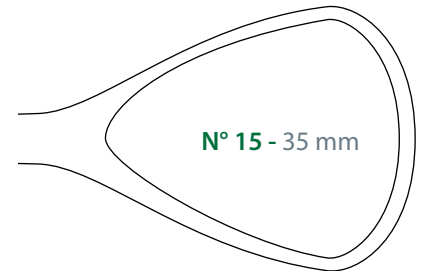

F303240	F303387
----------------	----------------

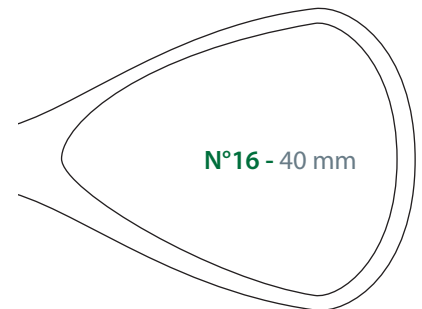



F30332
31 cm - 12 1/4"

CUZZI

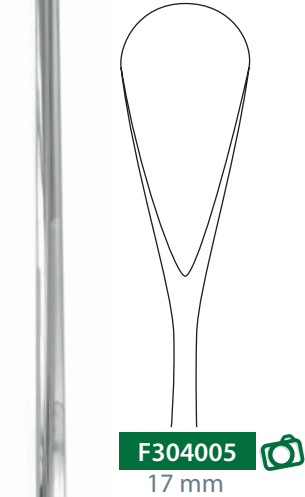

F304000
14 mm



F304005 
17 mm



F304010
20 mm

F304005
35 cm - 13 3/4"

HEANEY



7 mm

F304030
24 cm - 9 1/2"

PIRON

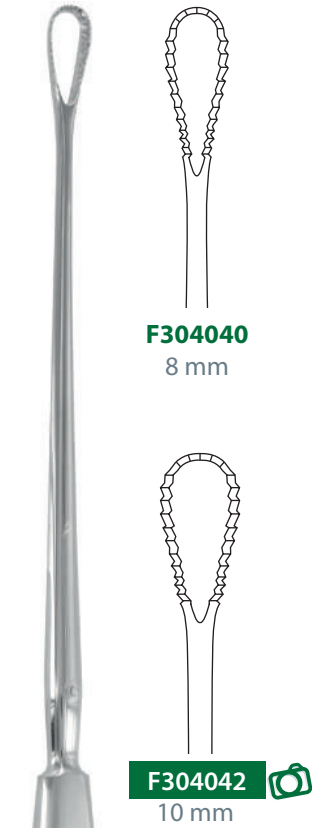

F304040
8 mm

F304042 
10 mm



F304044
12 mm

F304042
28,5 cm - 11 1/4"

POZZI

BLAKE

Tranchant
Sharp
Cortante

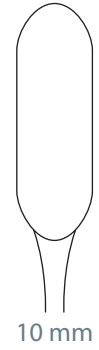

10 mm

F304050
26,5 cm - 10 1/2"

Tranchante
Sharp
Cortante

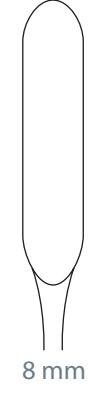

8 mm

F304065 
6 x 8 mm

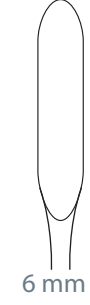

6 mm

F304060
4 x 6 mm

6 mm 4 mm

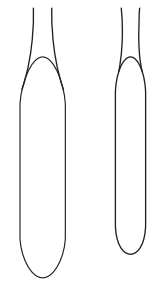

Tranchante
Sharp
Cortante

F304065
31 cm - 12 1/4"

Mousse
Blunt
Roma

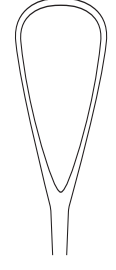

12 mm

Tranchante
Sharp
Cortante

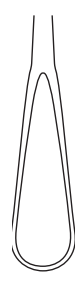

8 mm

F304070
27,5 cm - 10 1/4"

KEVORKIAN

Rigide
Rigid
Rigida



F304130
30 cm - 12"

Rigide
Rigid
Rigida



F304140
30 cm - 12"

Ø 4 mm



F304104
28 cm - 11"

Raccord pour aspiration
Connector for suction
Accesorio de succión



F304120
11cm - 4 1/2"

Ø 15 mm

-  **F304104** Ø 4 mm
- F304106** Ø 6 mm
- F304108** Ø 8 mm
- F304110** Ø 10 mm
- F304112** Ø 12 mm
- F304114** Ø 14 mm

MARTIN



F10805
34 cm - 13 1/2"

BREISKY



F10810
33 cm - 13"

SCHULTZE

Instruments pour hystéro-salpingographie
 Instruments for hystero-salpingography
 Instrumentos para histero-salpingografía



Complet
 Complete
 Completo
F304160

Sans manomètre
 Without manometer
 Sin manometro
 **F304170**

BRAUN

Dépresseur utérin
 Uterin depressor
 Depresor uterino



F304150
 28 cm - 11"

NOVACK

POZZI CHERON



F30420
24 cm - 9 1/2"
Ø 4 mm



A doigt
Collin's lock
Desmontable

A crochets
With hooks
Con ganchos

F30455
24 cm - 9 1/2"

CIRCERON (MATHIEU)



IVG

Manche à raccord tournant pour canule IVG
Handle with rotating connection for IVG cannula
Mango a racor rotativo para canula IVG



DOYEN



HEGAR

Modèle simple
Simple model
Modelo simple



F36160
18 cm - 7"

	Ø		Ø
F36010	1 mm	F36015	1,5 mm
F36020	2 mm	F36025	2,5 mm
F36030	3 mm	F36035	3,5 mm
F36040	4 mm	F36045	4,5 mm
F36050	5 mm	F36055	5,5 mm
F36060	6 mm	F36065	6,5 mm
F36070	7 mm	F36075	7,5 mm
F36080	8 mm	F36085	8,5 mm
F36090	9 mm	F36095	9,5 mm
F36100	10 mm	F36105	10,5 mm
F36110	11 mm	F36115	11,5 mm
F36120	12 mm	F36125	12,5 mm
F36130	13 mm	F36135	13,5 mm
F36140	14 mm	F36145	14,5 mm
F36150	15 mm	F36155	15,5 mm
F36160	16 mm	F36165	16,5 mm
F36170	17 mm	F36175	17,5 mm
F36180	18 mm	F36185	18,5 mm
F36190	19 mm	F36195	19,5 mm
F36200	20 mm		
F36210	21 mm		
F36220	22 mm		
F36230	23 mm		
F36240	24 mm		
F36250	25 mm		
F36260	26 mm		
F362610	27 mm		
F362620	28 mm		
F362630	29 mm		
F362640	30 mm		

PALMER



F366012
23 cm - 9"

	Ø
F366006	1 x 2 mm
F366009	2 x 3 mm
F366012	3 x 4 mm
F366015	4 x 5 mm
F366018	5 x 6 mm
F366021	6 x 7 mm
F366024	7 x 8 mm
F366027	8 x 9 mm
F366030	9 x 10 mm
F366033	10 x 11 mm
F366036	11 x 12 mm

Dilatateurs utérins - Uterine dilators - Dilatadores uterinos



Boîte complète de 4 à 17 mm
Complete case from 4 to 17 mm
Caja completa de 4 a 17 mm

 **F36270**

Boîte seule
Box only
Caja sóla

F36275 205 x 105 x 55 mm

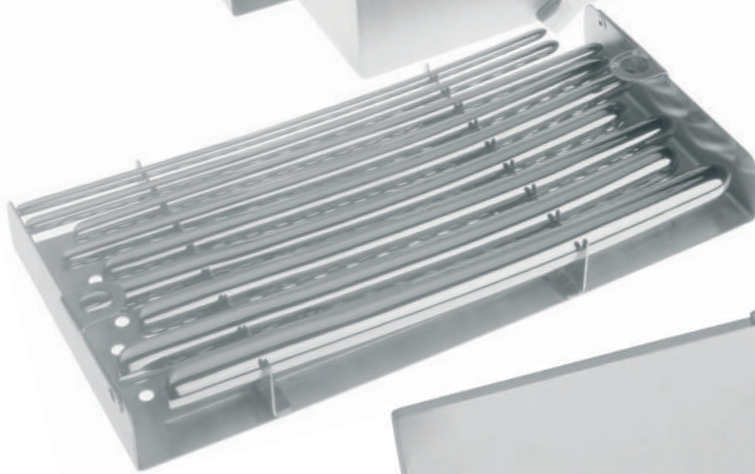

Boîte complète de 1 à 26 mm
Complete case from 1 to 26 mm
Caja completa de 1 a 26 mm

 **F36280**

Boîte seule
Box only
Caja sóla

F36285 310 x 200 x 60 mm



HEGAR

Modèle double
Double model
Modelo doble



	Ø
F36400	1 x 2 mm
F36410	3 x 4 mm
F36420	5 x 6 mm
F36430	7 x 8 mm
 F36440	9 x 10 mm
F36450	11 x 12 mm
F36460	13 x 14 mm
F36470	15 x 16 mm
F36480	17 x 18 mm
F36485	19 x 20 mm
F36490	21 x 22 mm
F36494	23 x 24 mm
F36498	25 x 26 mm



F36440
20 cm - 8"

HANK



	Ø	Fig. US
 F365050	4,5 x 5 mm	9/10
F365060	5,5 x 6 mm	11/12
F365070	6,5 x 7 mm	13/14
F365080	7,5 x 8 mm	15/16
F365090	8,5 x 9 mm	17/18
F365100	9,5 x 10 mm	19/20

F365050
27,5 cm - 10 ³/₄"

PRATT



	Ø
F365200	4,5 x 5,0 mm
F365201	5,6 x 6,3 mm
F365202	7,0 x 7,6 mm
 F365203	8,3 x 9,0 mm
F365204	9,6 x 10,3 mm
F365205	11,0 x 11,6 mm
F365206	12,3 x 13,0 mm
F365207	13,6 x 14,3 mm

F365203
29,5 cm - 11 ²/₃"



Hysteromètres - Uterine probes - Hysterómetros

VALLEIX



Curseur seul
Cursor alone
Cursor solo



F36310

F36300

29,5 cm - 11 ²/₃"

SIMS



Rigide
Rigid
Rigido

F36315 

Malléable
Malleable
Maleable

F363155

F36315

32 cm - 12 ¹/₂"

MARTIN (SIMPSON)



F363200

32 cm - 12 ¹/₂"

GUYON

Cathéter courbe (beniqué)
Curved dilating bougie
Bujia dilatadora curva

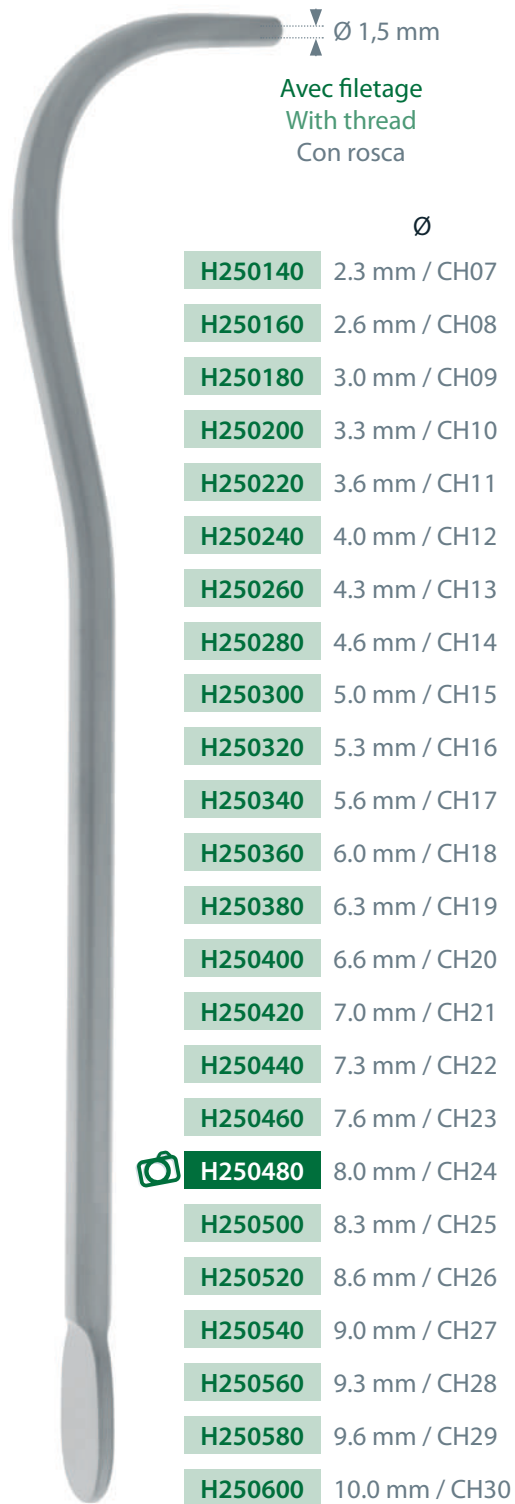

H250480
27 cm - 10^{3/4}"

Sondes métalliques
Metal catheters
Sondas metálicas



Acier chromé
Chrome steel
Acero cromado

Homme
Man
Hombre

Femme
Woman
Mujer

H251010	CH 10 - 3,3 mm	H251110
H251012	CH 12 - 4,0 mm	H251112
H251016	CH 16 - 5,3 mm	H251116
H251018	CH 18 - 6,0 mm	-

H251012
25 cm - 10"

H251112
15 cm - 6"

STRAUSS

Compresseur de l'urètre
Urethra compressor
Compresor para uretra



H20110-0
10,5 cm - 4^{1/8}"

PRATT



F153510
20,5 cm - 8"

MATHIEU



F153520
19,5 cm - 7 3/4"

TRELAT



F15340
20 cm - 8"

Avec crémaillère	Sans crémaillère
With rack	Without rack
Con cremallera	Sin cremallera



F15340

F15350

CZERNY

23 x 106 mm



F153540
22 cm - 8 3/4"

- F153626** 60 mm
- F153628** 80 mm
- F153630** 125 mm



F153628
22 cm - 8 3/4"

SIMS

18 x 80 mm



F153610

18 x 80 mm



F153620
15 cm - 6"

KELLY

Proctoscope
Proctoscope
Proctoscopio

F153350 22 x 100 mm

 **F153351** 22 x 140 mm

F153352 22 x 200 mm

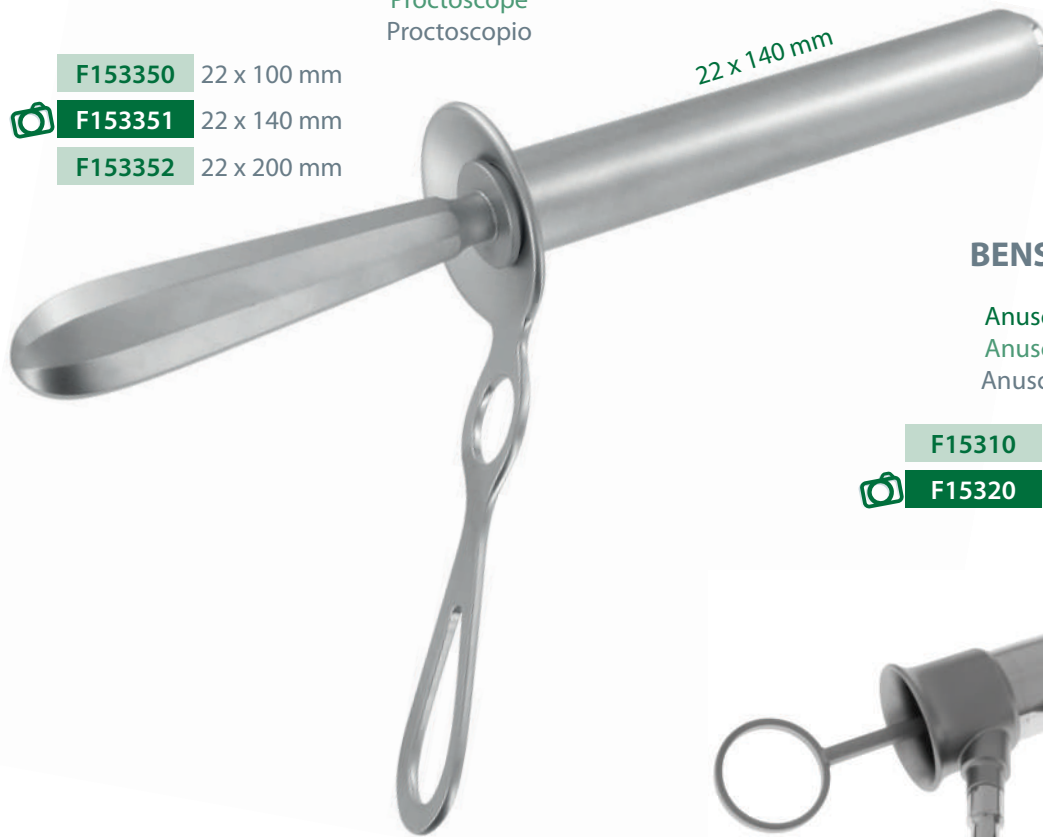

BENSAUDE

Anuscope
Anuscope
Anuscopio

F15310 19 x 70 mm

 **F15320** 22 x 70 mm



F153351

Sphinctéroscope
Sphincteroscope
Esfinteroscopio

F153340 21 x 50 mm

 **F153341** 27 x 50 mm



F153341

F15320
18 cm - 7"

BARR



B80885
17 cm - 6 ³/₄"

HALLE



F153360
9 cm - 3 ¹/₂"

ALAN PARKS

Avec 2 paires de valves latérales et 1 valve médiane
 With 2 pairs of lateral blades and 1 center blade
 Con 2 pares de Valvas laterales y 1 valva mediana

B80880

50 mm

Valves latérales (paire)
 Lateral blades (pair)
 Valvas laterales (par)

95 x 24 mm



B808850

75 x 24 mm



B808851



Valve médiane seule
 Central blade only
 Valvas mediana solas

95 x 24 mm

B808852

Pinces à biopsie rectale - Rectal biopsy forceps - Pinzas para biopsia rectal

YEOMAN



Rotative - Turntable - Giratorio





F109300
12 cm - 4^{3/4}"

F109310
14 cm - 5^{1/2}"



HEYWOOD SMITH

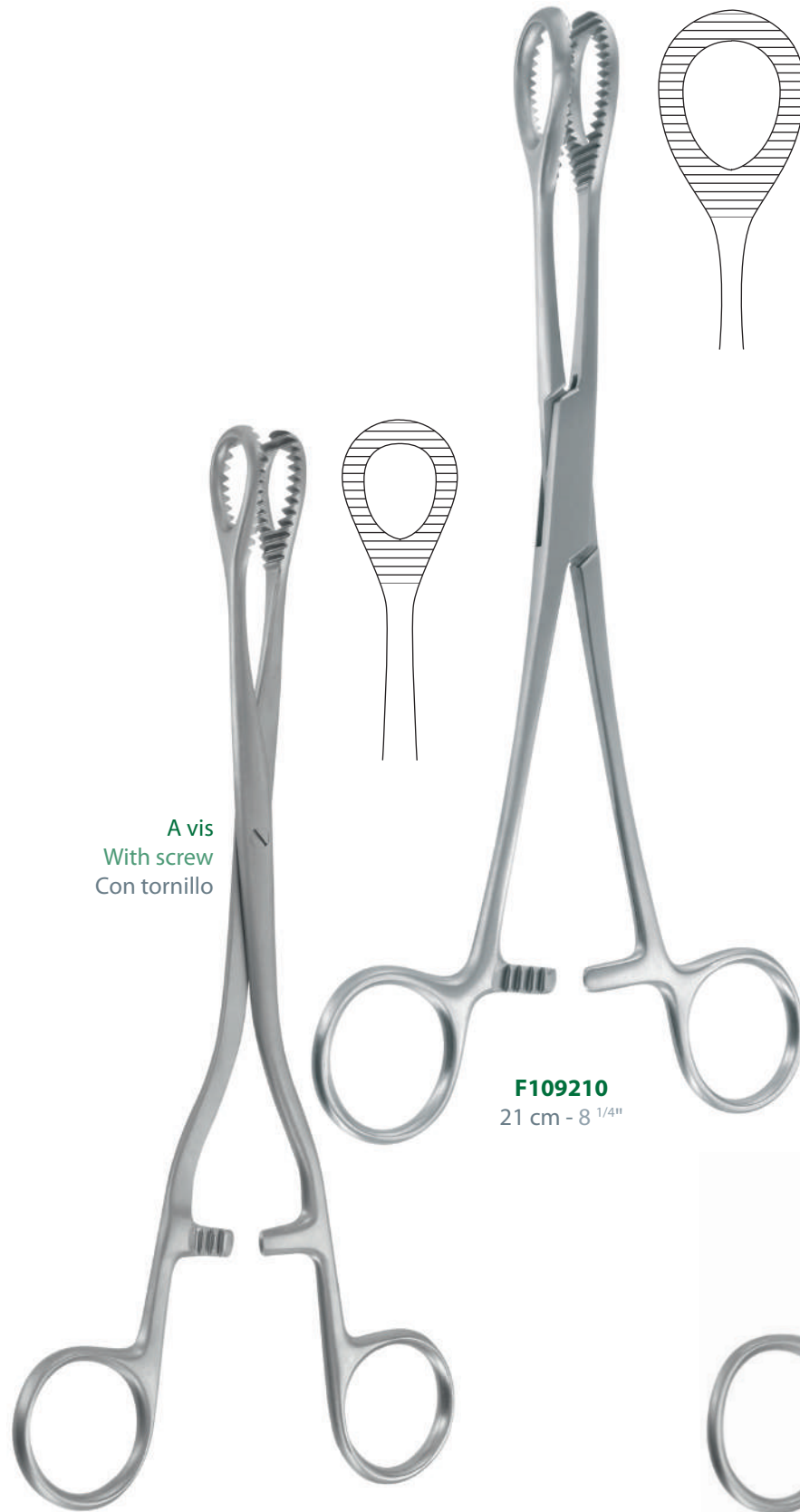

A vis
With screw
Con tornillo

F109200
20 cm - 8"

F109210
21 cm - 8 1/4"

MC GIVNEY



F109220
19 cm - 7 1/2"

METZENBAUM



B256770
28 cm - 11"

MILLIN

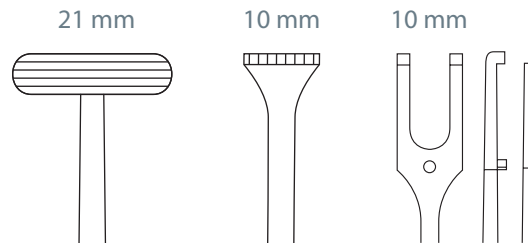

H10140
23 cm - 9"

H10145
23 cm - 9"

H10150
23 cm - 9"



H10140
23 cm - 9"

O'SHAUGNESSY



B606090
30 cm - 12"

SANTORINI



B953000
20 cm - 8"

YOUNG

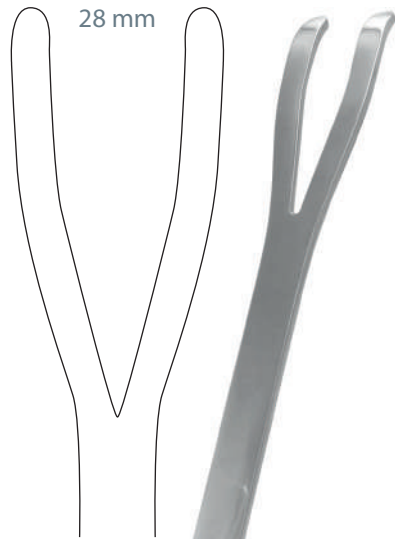

B804600
36 cm - 14"

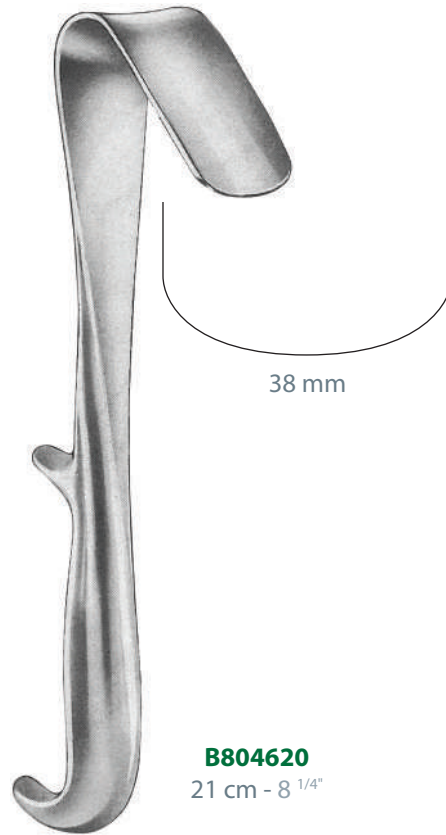

B804620
21 cm - 8 1/4"

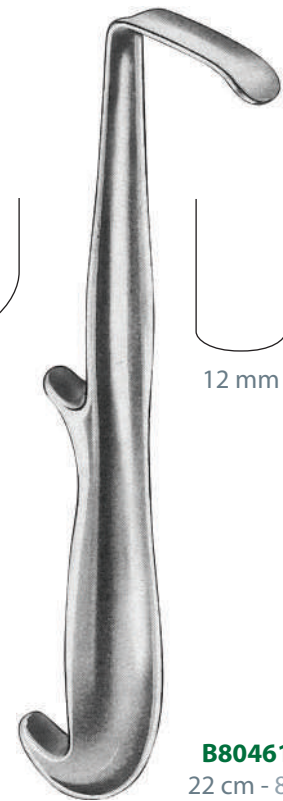

B804610
22 cm - 8 3/4"

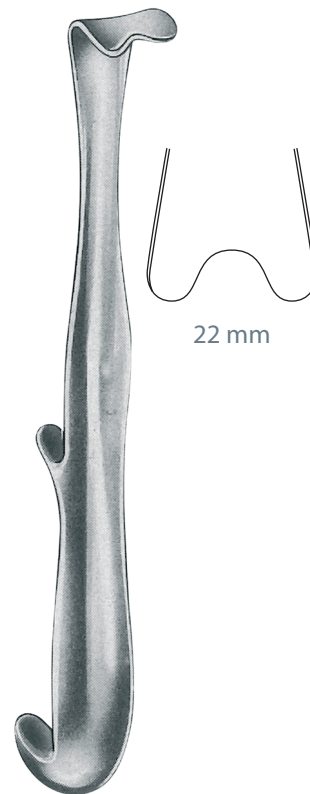

B804630
21 cm - 8 1/4"

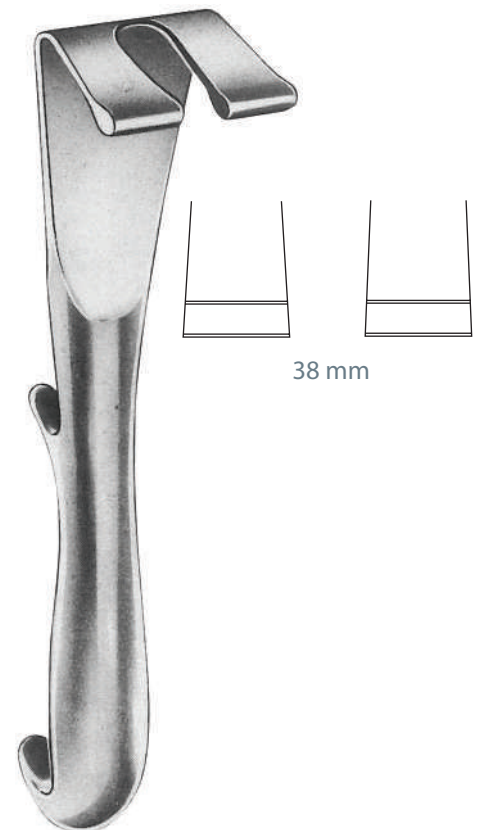

B804640
22 cm - 8 3/4"

Pinces pour calculs rénaux - Forceps for kidney stones - Pinzas para calculos renales



Pinces pour calculs biliaires - Forceps gales stones - Pinzas para calculos biliaires

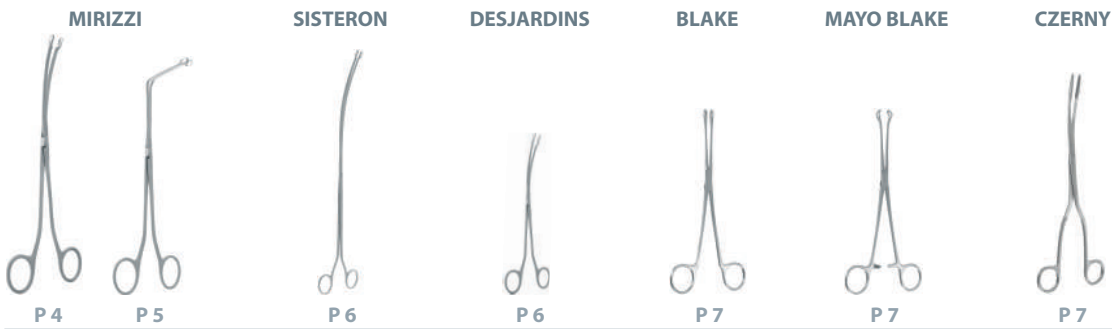

Instruments pour pédicules rénaux - Instruments for kidney pedicle - Pinzas para pedunculos renales



Instruments pour voies biliaires - Instruments for bile ducts - Instrumentos para vías biliares



Curettes pour voies biliaires - Curettes for bile ducts - Curetas para vías biliares



Dilatateurs pour voies biliaires - Dilators for bile ducts - Diladores para vías biliares

BAKES



P14

RANDALL



H100910
19 cm - 7 1/2"



H100910

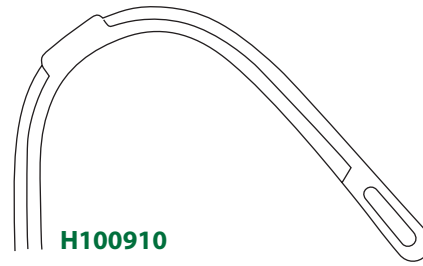

H100910
N° 6



H100911

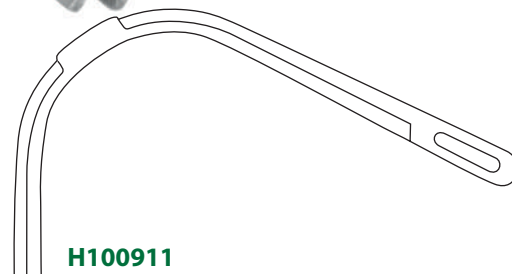

H100911
N° 5



H100921
23 cm - 9"

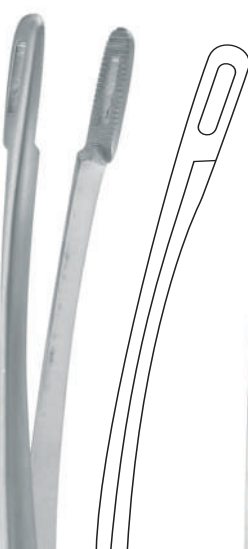

H100921
N° 1



H100922
N° 2



H100923
N° 3

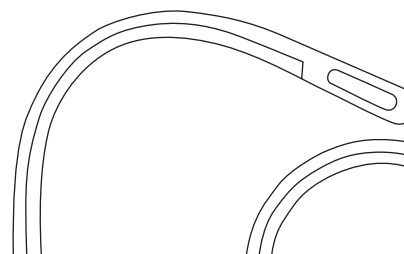

H100924
N° 4

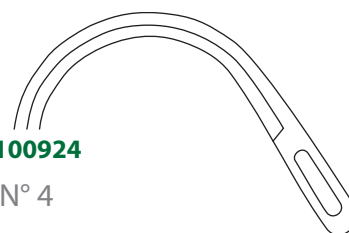

MIRIZZI



H10010
23 cm - 9"

N° 1



H10020
N° 2



H10030
N° 3



H10040
N° 4



H10050
N° 5

MIRIZZI



H10060
23 cm - 9"
N° 6



H10070
N° 7



H10080
N° 8



H10090
N° 9



SISTERON

DESJARDINS

6 mm **H10115** 

8 mm **H10120**

9 mm **H10130**



H10100
40 cm - 15 3/4"

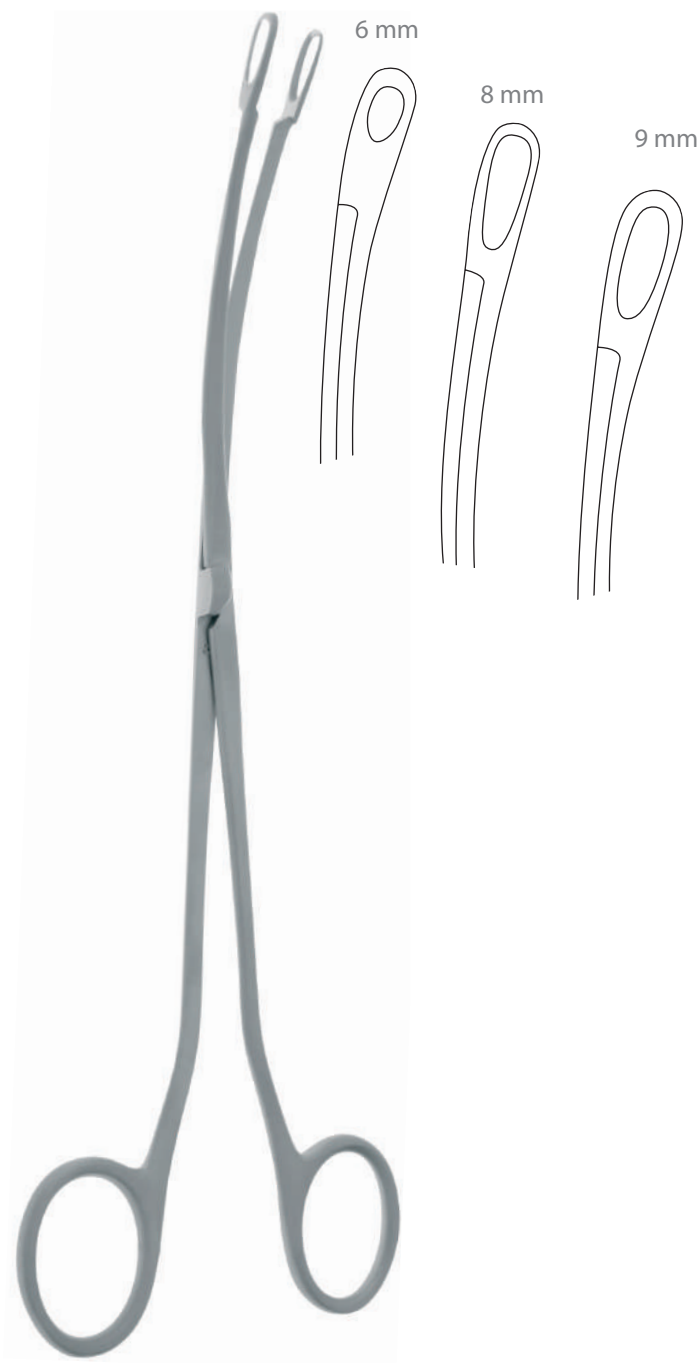

H10115
24 cm - 9 1/2"



BLAKE

MAYO BLAKE

CZERNY

Droit
Straight
Recta

Courbe
Curved
Curva

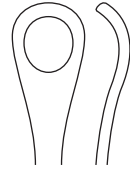

H101321
20 cm - 8"

Droit
Straight
Recta

Courbe
Curved
Curva



H101311
20,5 cm - 8"



H101320
20 cm - 8"



H101330
24,5 cm - 9 3/4"



H101310
20,5 cm - 8"

GUYON

- 20 cm - 8"  **B554000**
- 22 cm - 8 3/4" **B554005**
- 23 cm - 9" **B554025**
- 24 cm - 9 1/2" **B554010**

- Mors non traumatisants
Non-traumatic jaws
Bocas no traumáticas
- 23 cm - 9" **B554015**
 - 24 cm - 9 1/2" **B554020**

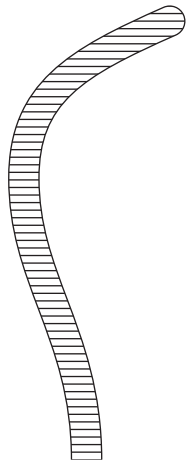

B554000

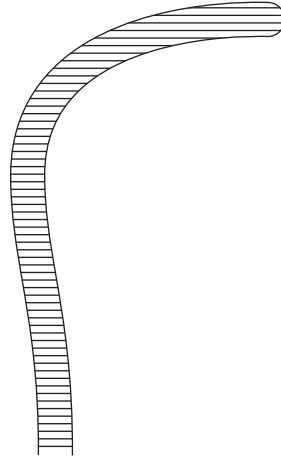

B554025

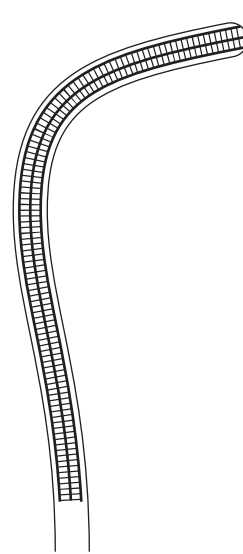

B554015

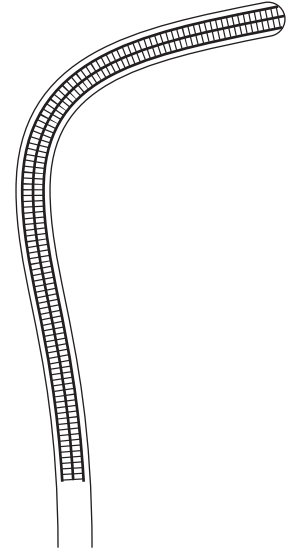

B554020

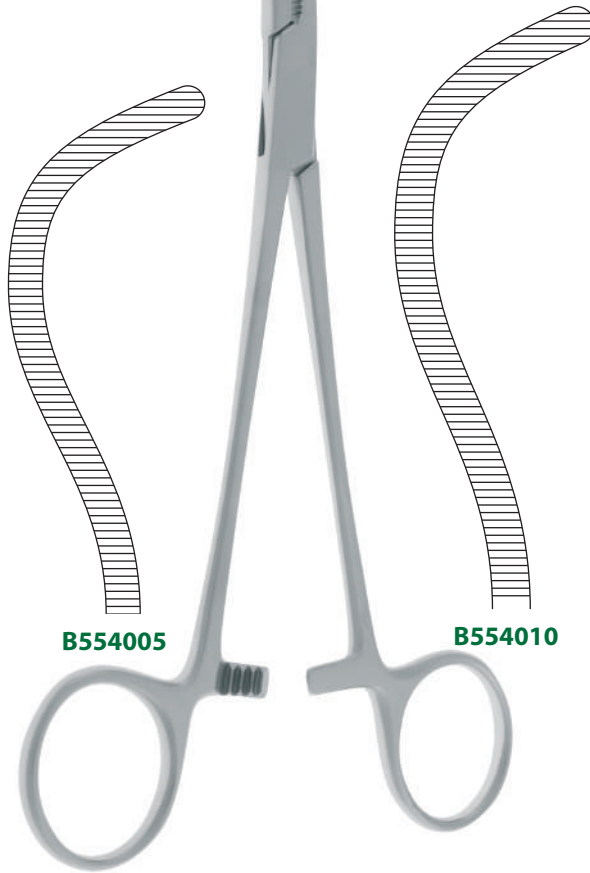

B554005

B554010

B554000
20 cm - 8"

MAYO-GUYON

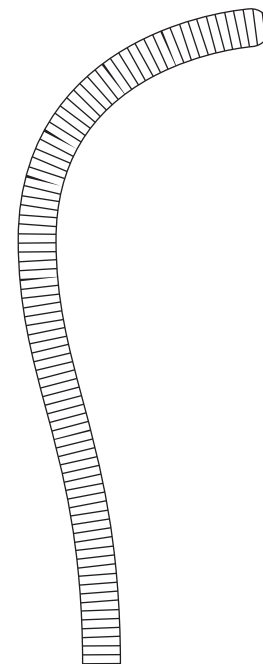

B554030
23 cm - 9"

STILLE

HERRICK

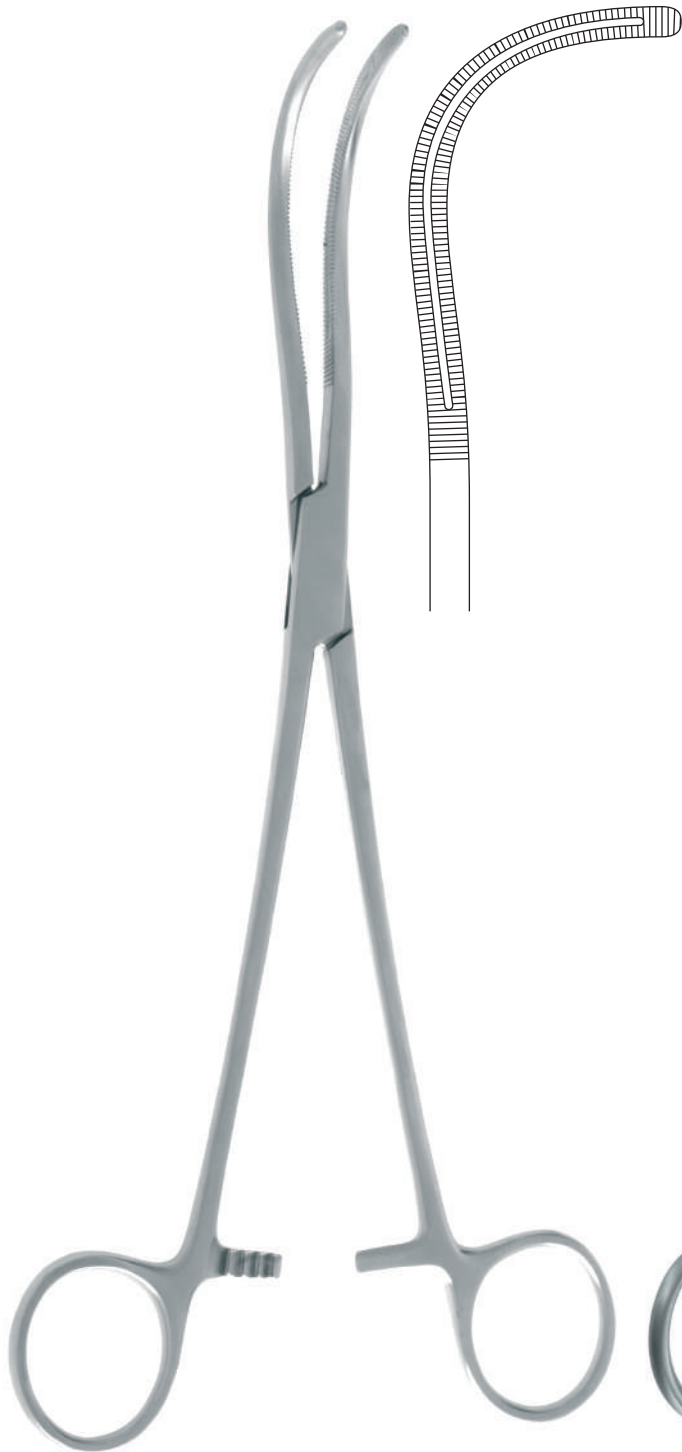

B50835
24 cm - 9 1/2 "

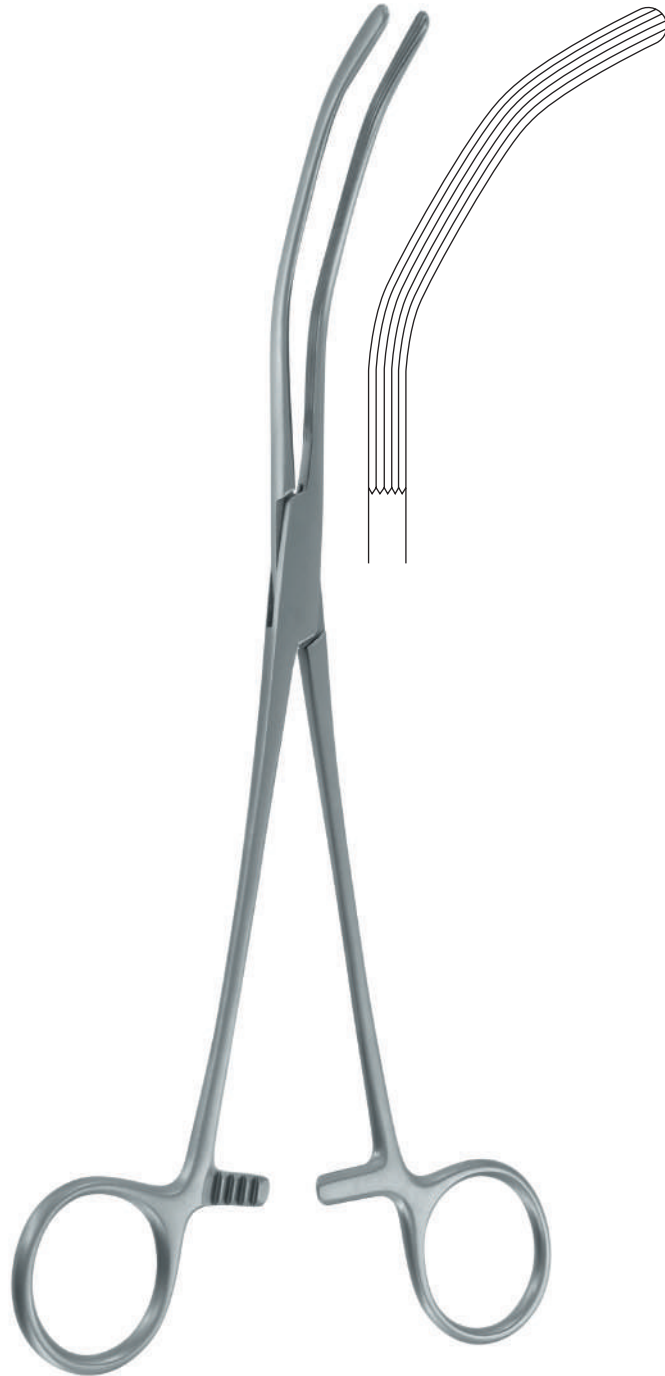

B554100
23 cm - 9 "

GRAY

Sans griffes
Without teeth
Sin dientes

22 cm - 8 3/4"

B554210

23 cm - 9"

B554200 

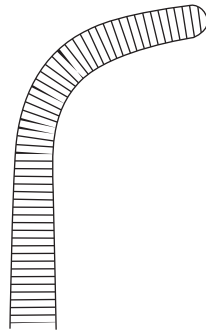

B554210

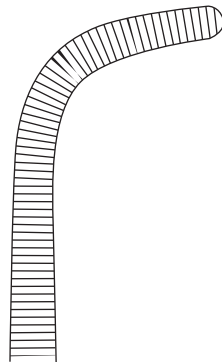

B554200

A griffes
With teeth
Con dientes

22 cm - 8 3/4"

B554211

23 cm - 9"

B554201

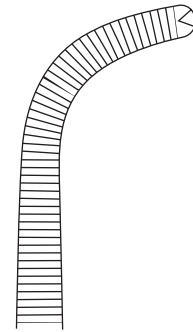

B554211

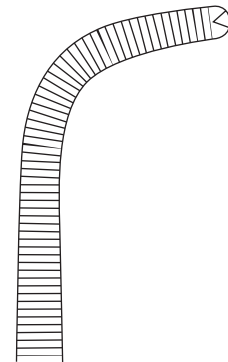

B554201

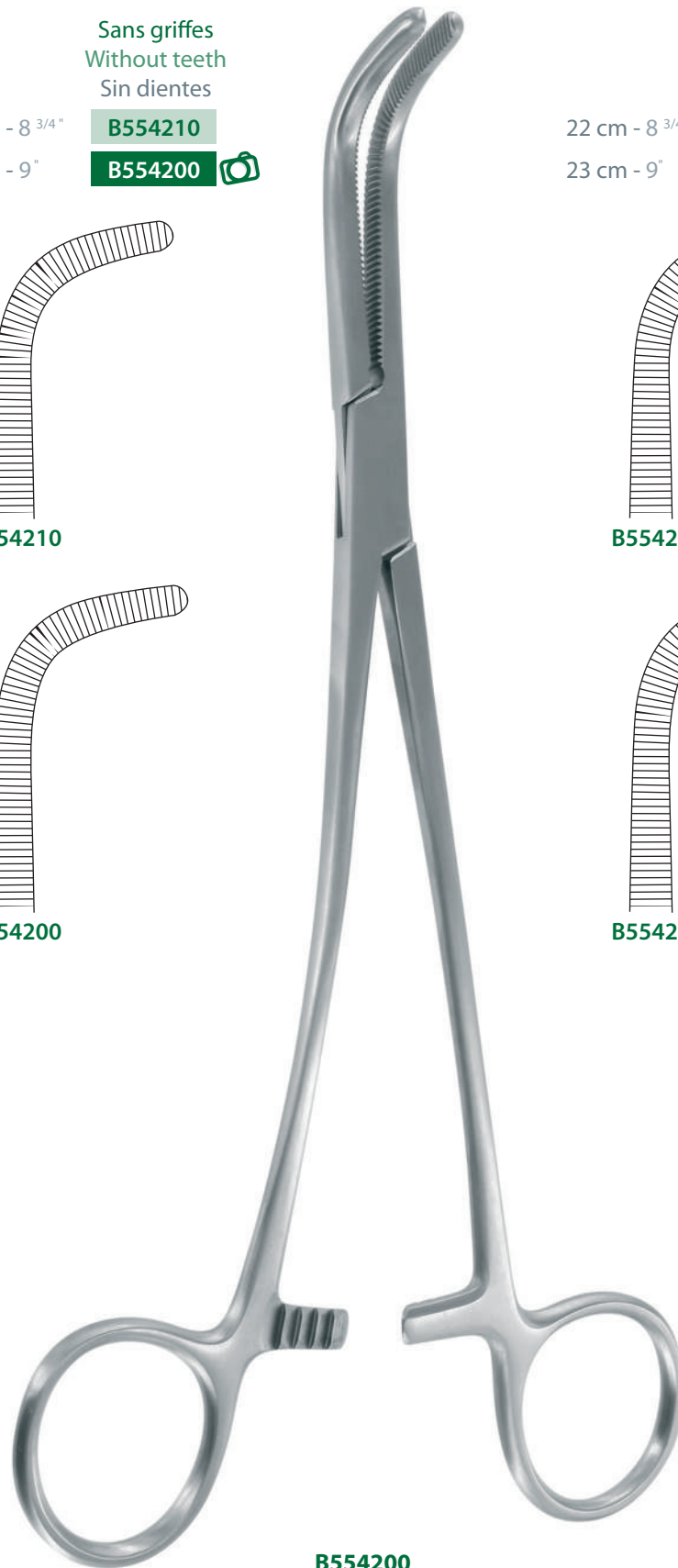

B554200
23 cm - 9"

BARRE

Pince à ailerons vésicaux
Vesical forceps
Pinzas para alabes vesicales

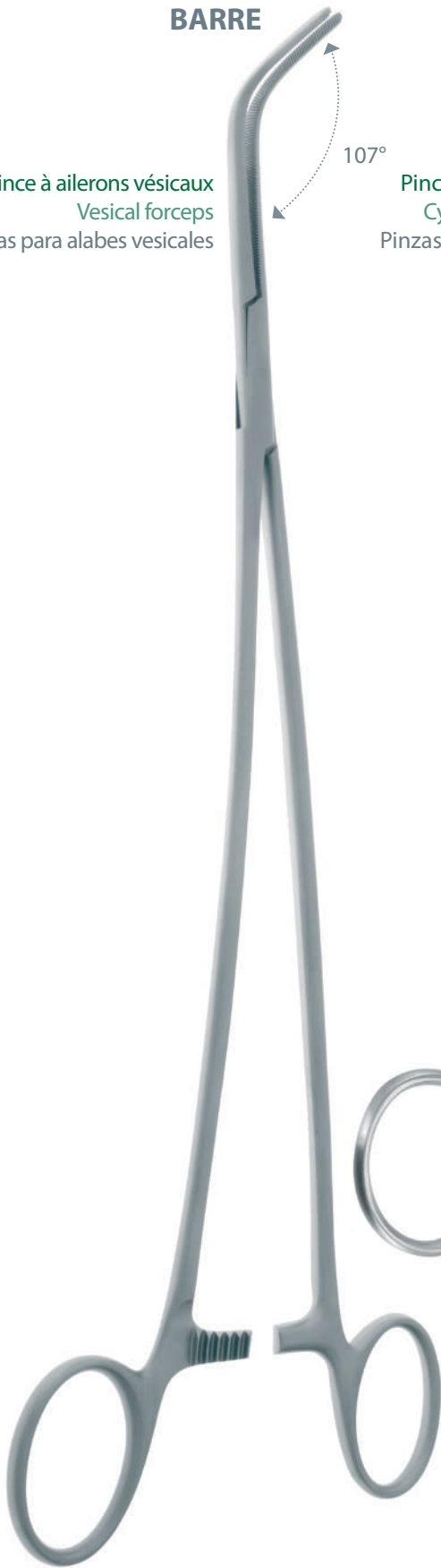

H10175
29 cm - 11 1/2 "

DESJARDINS

Pince à cystique
Cystic forceps
Pinzas para cístico



H200110
21 cm - 8 1/4 "

NISSEN

Pince à cystique
Cystic forceps
Pinzas para cístico



H200120
21 cm - 8 1/4 "

Curettes pour voies biliaires - Curettes for bile ducts - Curetas para vías biliares

DESJARDINS

Curette
Curette
Cureta

- 4 mm **H20025**
- 6 mm **H20030**
- 8 mm **H20040**
- 10 mm **H20050** 
- 12 mm **H20060**

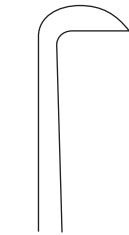

H20050



H20050

H20050
26 cm - 10 1/4 "

Explorateur
Probe
Explorador

- ø 4 mm **H20070**
- ø 6 mm **H20071** 
- ø 8 mm **H20072**



H20071
28 cm - 11"

Drague
Scoop
Draga

- ø 6 mm **H20080**
- ø 7 mm **H20081**
- ø 8 mm **H20082**
- ø 9 mm **H20083** 



H20083
30 cm - 11 3/4 "

LUER KOERTE

Malléable
Malleable
Maleable

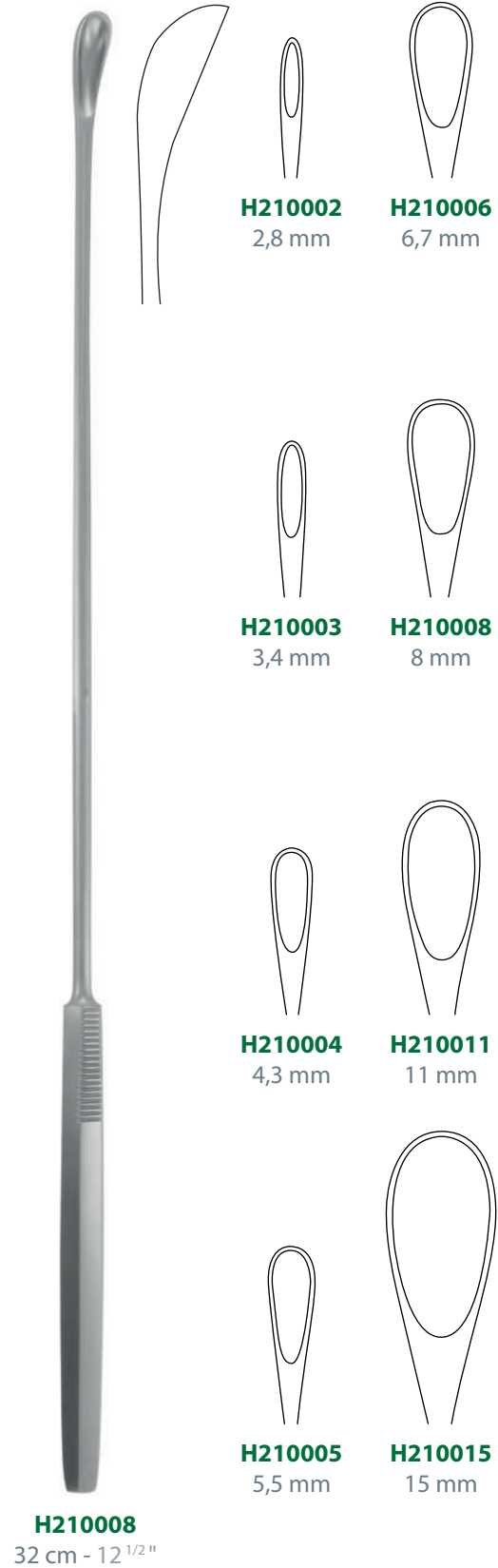

H210008
32 cm - 12 1/2"

H210002
2,8 mm

H210006
6,7 mm

H210003
3,4 mm

H210008
8 mm

H210004
4,3 mm

H210011
11 mm

H210005
5,5 mm

H210015
15 mm

BAKES



H40030
30 cm - 11 3/4 "



1 mm
H40010
N° 1



2 mm
H40020
N° 2



3 mm
H40030
N° 3



4 mm
H40040
N° 4



5 mm
H40050
N° 5



6 mm
H40060
N° 6



7 mm
H40070
N° 7



8 mm
H40080
N° 8



9 mm
H40090
N° 9



10 mm
H40100
N° 10



11 mm
H40110
N° 11



12 mm
H40120
N° 12



13 mm
H40130
N° 13

Microchirurgie ciseaux - Microsurgery scissors - Microcirugía tijeras

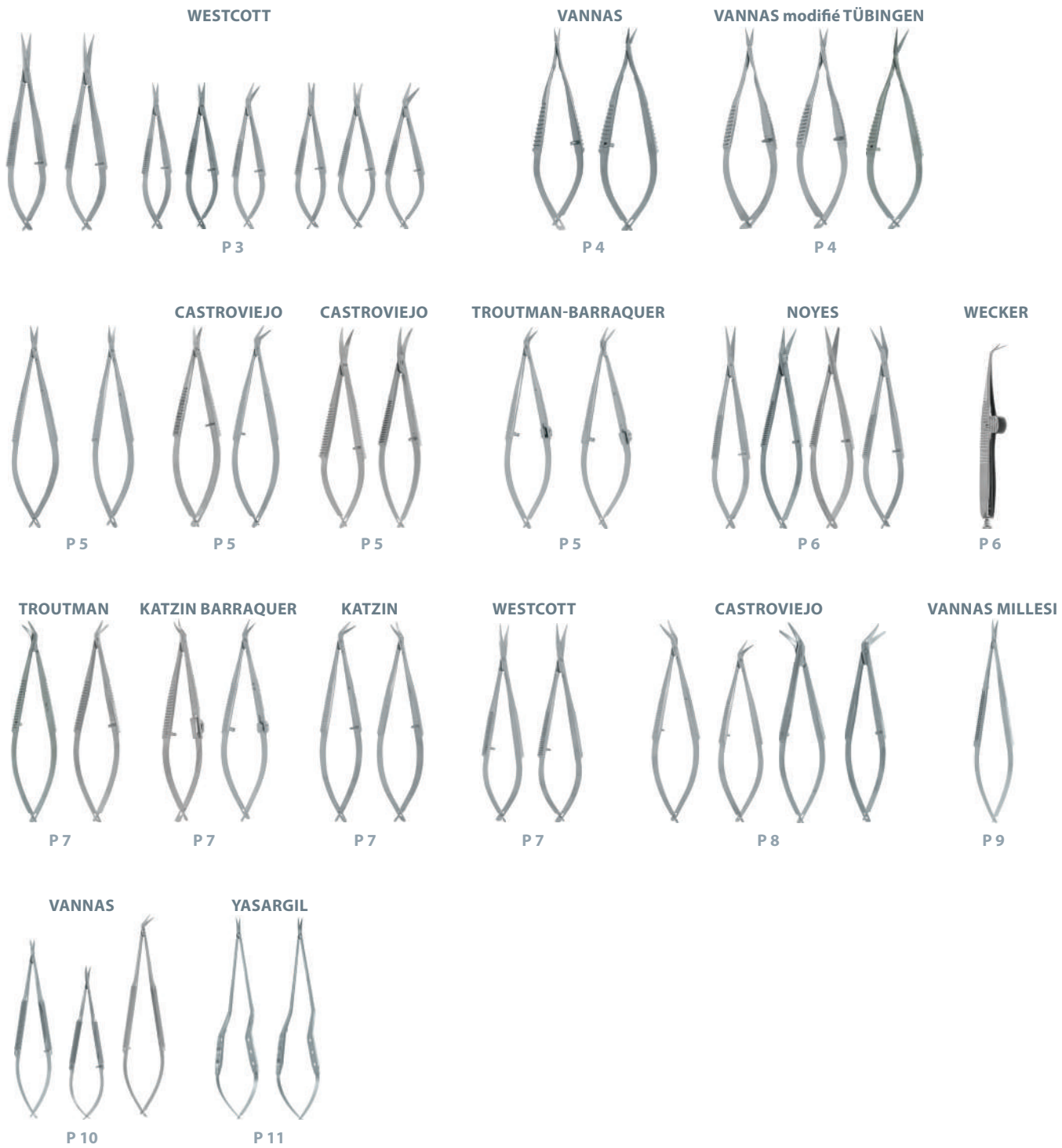

Microchirurgie porte-aiguilles - Microsurgery needle-holders - Microcirugía porta-agujas



Microchirurgie pinces fines - Microsurgery fine forceps - Microcirugía pinzas finas

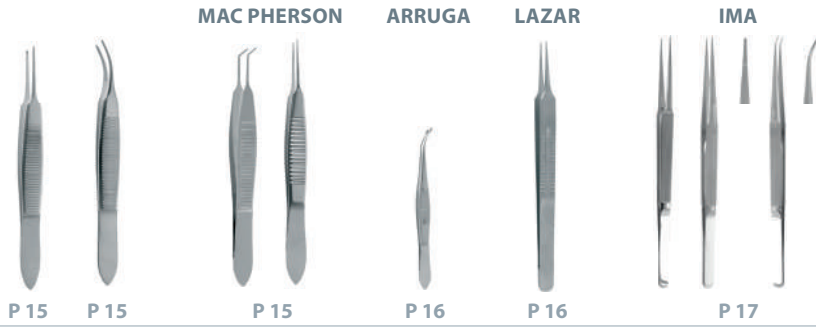

Microchirurgie crochets - Microsurgery hooks - Microcirugía ganchos

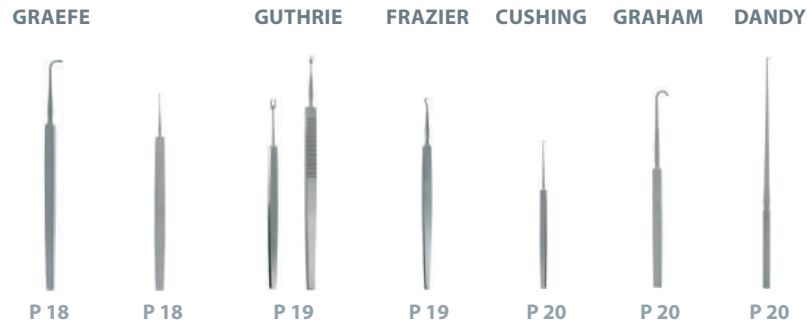

Écarteurs, crochets - Retractors, hooks - Separadores, ganchos

VII - Ecarteurs
VII - Retractors
VII - Separadores



O.R.L. crochets - E.N.T. hooks - O.R.L. ganchos

XII - O.R.L.
XII - E.N.T.
XII - O.R.L.

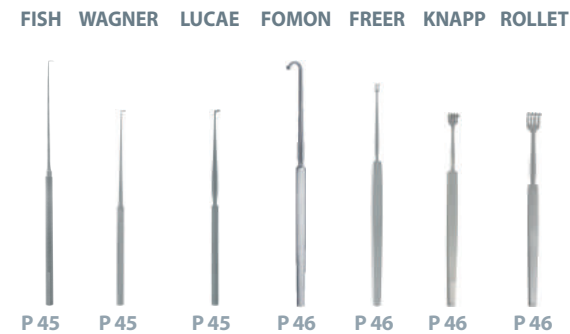

WESTCOTT

Pointu - Sharp - Aguda



Droit
Straight
Recta



D021042

11,5 cm - 4 1/2"



Courbe
Curved
Curva



D021052

11,5 cm - 4 1/2"

Pointu - Sharp - Aguda

Droit
Straight
Recta



D021062

9,5 cm - 3 3/4"

Droit
Straight
Recta



D021061

9,5 cm - 3 3/4"

Coudé
Angular
Angulada



D021082

9,5 cm - 3 3/4"

Droit
Straight
Recta



D021060

9,5 cm - 3 3/4"

Courbe
Curved
Curva



D021070

9,5 cm - 3 3/4"

Coudé
Angular
Angulada



D021080

9,5 cm - 3 3/4"

Mousse - Blunt - Roma

VANNAS

Pointu - Sharp - Aguda

Droit
Straight
Recta



D020010
8,5 cm - 3 1/2"

Courbe
Curved
Curva



D020020
8,5 cm - 3 1/2"

Coudé vers le haut
Angled up
Accodades hacia arriba



D020035
8,5 cm - 3 1/2"

VANNAS modifié TÜBINGEN

Droit
Straight
Recta



D020040
8,5 cm - 3 1/2"

Courbe
Curved
Curva



D020045
8,5 cm - 3 1/2"

Coudé vers le haut
Angled up
Accodades hacia arriba



D020055
8,5 cm - 3 1/2"

Microchirurgie ciseaux - Microsurgery scissors - Microcirugía tijeras

Pointu - Sharp - Aguda

Droit
Straight
Recta



D021102
10 cm - 4"

Courbe
Curved
Curva



D021112
10 cm - 4"

Pointu
Sharp
Aguda

Courbe
Curved
Curva



D021122
10 cm - 4"

CASTROVIEJO

Mousse
Blunt
Roma

Coudé
Angled
Angulada



D021130
10 cm - 4"

CASTROVIEJO

Pointu / Pointu
Sharp / Sharp
Aguda / Aguda



D021142
10 cm - 4"

Lames longues
Long baldes
Lamas largas



D021140
10 cm - 4"

Mousse / Mousse
Blunt / Blunt
Roma / Roma

TROUTMAN-BARRAQUER

A gauche
On the left
A la Izquierda



D021150
10 cm - 4"

Coudé
Angled
Angulada

A droite
On the right
A la Derecha



D021160
10 cm - 4"

NOYES

Pointu / Pointu
Sharp / Sharp
Aguda / Aguda



Droit
Straight
Recta

D021002
12 cm - 4 3/4"



Coudé
Angled
Angulada

D021012
12 cm - 4 3/4"

Pointu / Mousse
Sharp / Blunt
Aguda / Roma



Droit
Straight
Recta

D021001
12 cm - 4 3/4"



Coudé
Angled
Angulada

D021011
12 cm - 4 3/4"

Mousse / Mousse
Blunt / Blunt
Roma / Roma



Droit
Straight
Recta

D021000
12 cm - 4 3/4"



Coudé
Angled
Angulada

D021010
12 cm - 4 3/4"

WECKER

Coudé
Angled
Angulada

Pointu / Pointu
Sharp / Sharp
Aguda / Aguda



D021022
11 cm - 4 1/2"

Microchirurgie ciseaux - Microsurgery scissors - Microcirugía tijeras

TROUTMAN



D021170
10 cm - 4"



D021180
10 cm - 4"

KATZIN-BARRAQUER



D021190
10 cm - 4"



D021200
10 cm - 4"

KATZIN



D021210
10 cm - 4"



D021220
10 cm - 4"

Pointu / Pointu
Sharp / Sharp
Aguda / Aguda

Courbe
Curved
Curva



D021232
11 cm - 4 1/2"

WESTCOTT

Mousse / Mousse
Blunt / Blunt
Roma / Roma

Courbe
Curved
Curva



D021230
11 cm - 4 1/2"

CASTROVIEJO

Mousse - Blunt - Roma

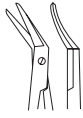

Coudé
Angled
Angulada
A gauche
On the left
A la Izquierda

D021250
10 cm - 4"

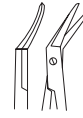

Coudé
Angled
Angulada
A droite
On the right
A la Derecha

D021260
10 cm - 4"

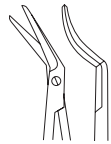

Coudé
Angled
Angulada
A gauche
On the left
A la Izquierda

D021270
11 cm - 4 1/2"

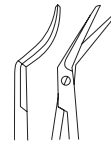

Coudé
Angled
Angulada
A droite
On the right
A la Derecha

D021280
11 cm - 4 1/2"

Microchirurgie ciseaux - Microsurgery scissors - Microcirugía tijeras

VANNAS MILLESI

	Droit Straight Recta	Pointu Sharp Aguda	Pointu, fin Sharp, fine Aguda, fina	Pointu, dentelé Sharp, serrated Aguda, dentellada
16 cm - 6 1/4"		D020400	D020410	D020420
	Courbe Curved Curva	Pointu Sharp Aguda	Pointu, fin Sharp, fine Aguda, fina	Pointu, dentelé Sharp, serrated Aguda, dentellada
16 cm - 6 1/4"		D020401	D020411	D020421 



D020400
D020420



D020410



D020401
D020421



D020411



D020421
16 cm - 6 1/4"

Microchirurgie ciseaux - Microsurgery scissors - Microcirugía tijeras

Manche ronds - Round handle - Mango redondo

VANNAS

	Droit Straight Recta	Pointu Sharp Aguda	Mousse Blunt Roma	Pointu, fin Sharp, fine Aguda, fina	Pointu, dentelé Sharp, serrated Aguda, dentellada
14 cm - 5 1/2"	D020090	-	-	-	-
16 cm - 6 1/4"	-	-	-	D020210	D020220
18 cm - 7"	D020290	-	-	-	-
	Courbe Curved Curva	Pointu Sharp Aguda	Mousse Blunt Roma	Pointu, fin Sharp, fine Aguda, fina	Pointu, dentelé Sharp, serrated Aguda, dentellada
14 cm - 5 1/2"	D02010	D02020	-	-	-
16 cm - 6 1/4"	-	-	-	D020211	D020221
18 cm - 7"	D02030	-	-	-	-
	Coudé Angular Angulada	Pointu Sharp Aguda			
18 cm - 7"	D020310	-			

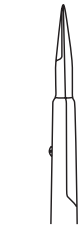
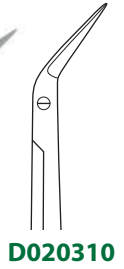

D020210

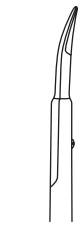

D020211



D020290



D02010



D02020

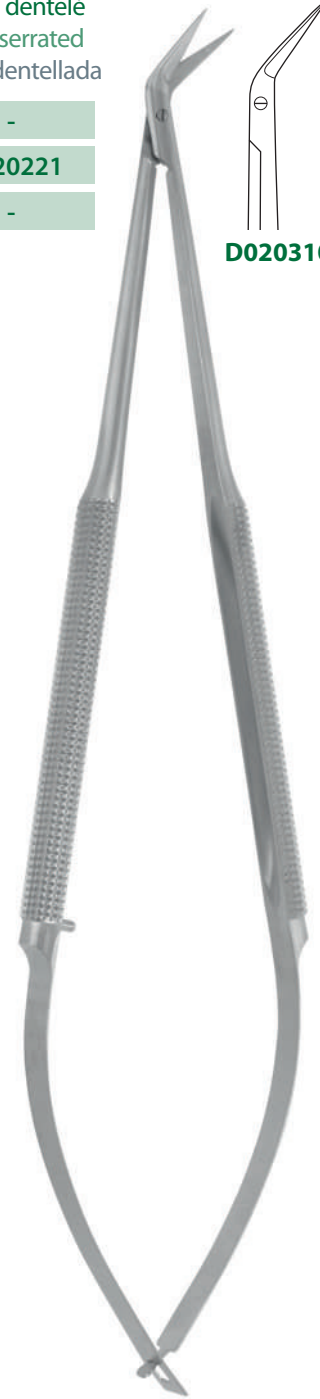

D020210
16 cm - 6 1/4"

D02020
14 cm - 5 1/2"

D020310
18 cm - 7"

YASARGIL

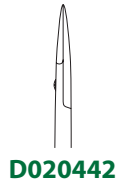
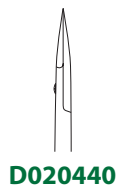

D020450
22,5 cm - 8 3/4"

Droit Straight Recta	Pointu Sharp Aguda	Mousse Blunt Roma
16,5 cm - 6 1/2"	D020430	-
20 cm - 8"	D020440	D020442
22,5 cm - 8 3/4"	D020450	D020452

Courbe Curved Curva	Pointu Sharp Aguda	Mousse Blunt Roma
16,5 cm - 6 1/2"	D020431	-
20 cm - 7 3/4"	D020441	D020443
22,5 cm - 8 3/4"	D020451	D020453

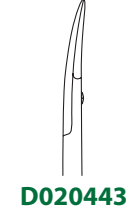
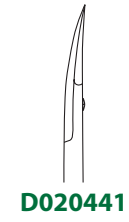

D020453
22,5 cm - 8 3/4"

CASTROVIEJO

Avec verrou - With lock - Con cerradura



TC Inserts



TC Inserts

	Mors lisses Smooth jaws Boca lisa	Mors striés Stria jaws Boca estriada		Mors lisses Smooth jaws Boca lisa	Mors striés Stria jaws Boca estriada
Droit Straight Recto					
14 cm - 5 1/2"	D01010	D010110	14 cm - 5 1/2"	D010290	D01030
Courbe Curved Curvo					
14 cm - 5 1/2"	D01020	D010210	14 cm - 5 1/2"	D010390	D01040

Mors lisses
Smooth jaws
Boca lisa



D01010



D01020

Mors striés
Stria jaws
Boca estriada



D010110



D010210

Mors lisses
Smooth jaws
Boca lisa



D010290



D010390

Mors striés
Stria jaws
Boca estriada



D01030



D01040



D01010
14 cm - 5 1/2"



D01040
14 cm - 5 1/2"

LANDANGER

Microchirurgie porte-aiguilles - Microsurgery needle-holders - Microcirugía porta-agujas

JACOBSON



TC Inserts

YASARGIL

	JACOBSON		YASARGIL	
	Droit Straight Recto	Courbe Curved Curvo	Droit Straight Recto	Courbe Curved Curvo
18 cm - 7"	D010440	D010460	D01050	D010550
20 cm - 8"	-	-	D010501	-
22,5 cm - 8 ^{3/4} "	-	-	D010502	-
	D012000	D012010		
	-	-		
	D012020	D012030		

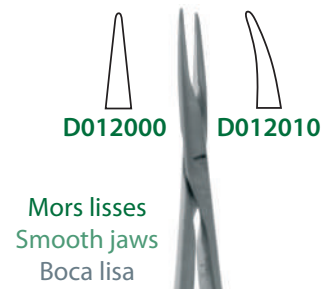

Avec verrou
With lock
Con cerradura



D010440
18 cm - 7"



D01050
18 cm - 7"





D012000
18 cm - 7"

X - Microchirurgie
X - Microsurgery
X - Microcirugía

BARRAQUER



TC Inserts

Mors lisses Smooth jaws Boca lisa	Droit Straight Recto	Courbe Curved Curvo	Mors striés Stria jaws Boca estriada	Droit Straight Recto	Courbe Curved Curvo
13 cm - 5" 	D01060	D01070	14 cm - 5 1/2"	D010790	D01080
18 cm - 7"	D01090	D01100	18 cm - 7" 	D011100	D011110

Avec verrou / With lock / Con cerradura

13 cm - 5"	D010650	D010750
------------	----------------	----------------

Mors lisses
Smooth jaws
Boca lisa



D01060
13 cm - 5"



D011100
18 cm - 7"

Microchirurgie pinces fines - Microsurgery fine forceps - Microcirugía pinzas finas

Droite
Straight
Recta



D03080
7 cm - 2 3/4"

Sans griffes
Without teeth
Sin dientes

Mors striés
Striated jaws
Bocas estriadas

Courbe
Curved
Curva



D03090
7 cm - 2 3/4"

Droite
Straight
Recta



D03060
7 cm - 2 3/4"

A griffes
With teeth
Con dientes

Courbe
Curved
Curva



D03070
7 cm - 2 3/4"

MAC PHERSON

A plateau - With platform - Con plataforma

Droite
Straight
Recta



D03120
8 cm - 3 1/4"

Sans griffes
Without teeth
Sin dientes

Mors lisses
Smooth jaws
Boca lisa

Coudée
Angled
Anglada



D03130
8 cm - 3 1/4"

Droite
Straight
Recta



D03100
8 cm - 3 1/4"

A griffes
With teeth
Con dientes

Coudée
Angled
Anglada



D03110
8 cm - 3 1/4"

LAZAR

ARRUGA

Pince capsulaire
Capsule forceps
Pinza capsular



D03160
10 cm - 4"

0,5 mm

0,8 mm



D031400
15,5 cm - 6"



D031400



D031405

Avec plateau - With platform - Con plataforma

IMA

Droite
Straight
Recta

Courbe
Curved
Curva

D031410

12 cm - 4 3/4"

D031411

D031420

15 cm - 6"

D031421



D031430

18 cm - 7"

D031431



Droite
Straight
Recta



D031440
18 cm - 7"



A griffes
With teeth
Con dientes



D031430
18 cm - 7"



D031431
18 cm - 7"

GRAEFE

Boutonné - Buttoned - Abotonado

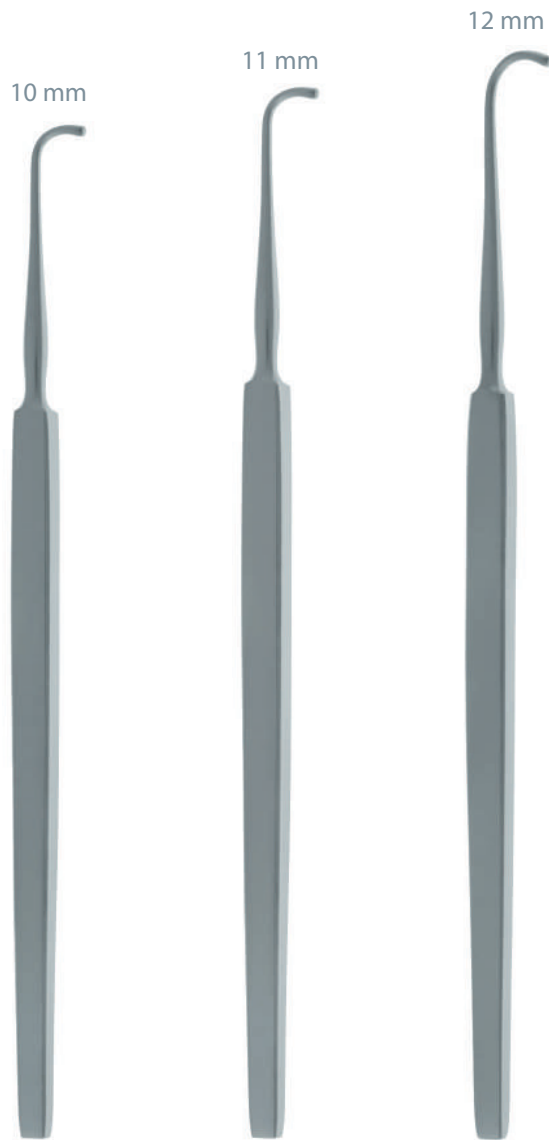

D040210
13,5 cm - 5 1/4"

D040211
14 cm - 5 1/2"

D040212
14,5 cm - 5 3/4"

Mousse
Blunt
Romo

Pointu
Sharp
Agudo

2 mm

2 mm



D04010
12 cm - 4 3/4"



D04020
12 cm - 4 3/4"

GUTHRIE

FRAZIER

À nerf - For nerve - Para nervios

Fin
Fine
Fino

2,5 mm

Fort
Strong
Fuerte

3 mm

13 cm - 5"

D040440 

18 cm - 7"

D040441

2,5 mm



D040390
12 cm - 4 ³/₄"



D040410
16 cm - 6 ¹/₄"



D040411
16 cm - 6 ¹/₄"

3,5 mm



D040440
13 cm - 5"



CUSHING

3 mm
Pointu
Sharp
Agudo



D040420
14 cm - 5 1/2"

GRAHAM

9 mm
Mousse
Blunt
Romo



D040700
16,5 cm - 6 1/2"

DANDY

6 mm
Mousse
Blunt
Romo



D040710
22 cm - 8 1/2"

Spatules - Spatulas - Espátulas

CLOVIS VINCENT

OLIVECRONA

HEIFETZ

AACHEN



P 3



P 4



P 4



P 5



P 5

Écarteurs - Retractors - Separadores

LOVE

CASPAR

TAYLOR

HOLSHER

HESS



P 6



P 7



P 7



P 7



P 8



P 8

Perforateur - Bone drill - Perforador

DOYEN

HUDSON

CUSHING

MC KENZIE

ERRICO



P 9



P 10



P 10



P 10



P 10

Pincers rongeurs - Rongeurs Forceps - Pinzas para laminectomía

CASPAR

CASPAR

FERRIS-SMITH-CUSHING

WEIL-BLAKESLEY



P 11



P 12



P 13



P 14



P 15

Pincers emporte pièces - Punches forceps - Pinzas sacabocados

FERRIS-SMITH-KERRISSON

Revêtement noir
Black coated
Negro recubierto

FERRIS-SMITH-KERRISSON

Revêtement noir
Black coated
Negro recubierto



P 16



P 17



P 18



P 19



P 20 - 21













P 22

















P 23

Écarteurs - Retractors - Separadores

VII - Ecarteurs
VII - Retractors
VII - Separadores

JANSEN DEEP	JANSEN	PLESTER	WEITLANER	WEITLANER	TRAVERS	HENLEY	MAC KEE	NORFOLK NORWICH	WEITLANER
									
P 112	P 112	P 113	P 114	P 115	P 115	P 116	P 117	P 117	P 118

WEITLANER WULLSTEIN	WEITLANER NEURO	ANDERSON ADSON	BECKMANN CONE	BECKMANN	BECKMANN	BECKMANN	DECOULX	BECKMANN EATON
								
P 118	P 119	P 119	P 120	P 120	P 121	P 122	P 123	P 124

ADSON	BECKMANN ADSON	ADSON	WALTON	MARKHAM MEYERDING
				
P 124	P 125	P 126	P 127	P 128

Encore plus d'instruments dédiés dans notre catalogue Ortho-Vertèbre
Even more dedicated instruments in our Ortho-Vertebra catalog
Incluso más instrumentos dedicados en nuestro catálogo de Orto-Vértebras



CLOVIS VINCENT

Lame malléable - Malleable spatula - Espátula maleable

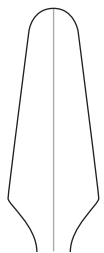

A **J150100**
18 cm - 7"

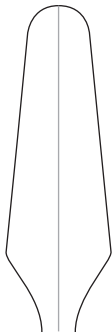

B **J150110**
19 cm - 7 1/2"

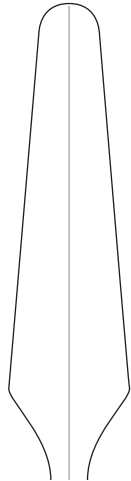

C **J150120**
21 cm - 8 1/4"

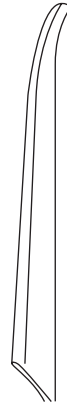

D **J150130**
21 cm - 8 1/4"

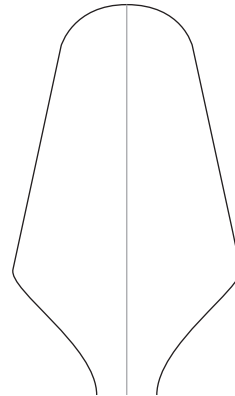

F **J150140**

F

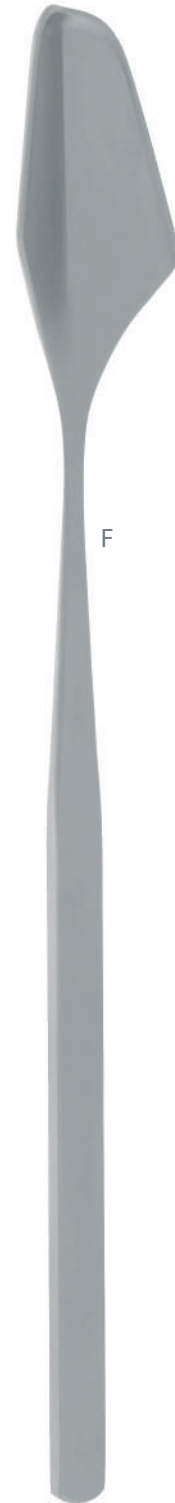

J150140
20 cm - 8"

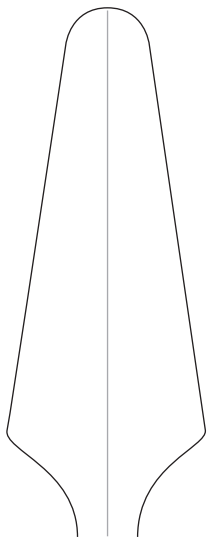

G **J150150**
22 cm - 8 3/4"

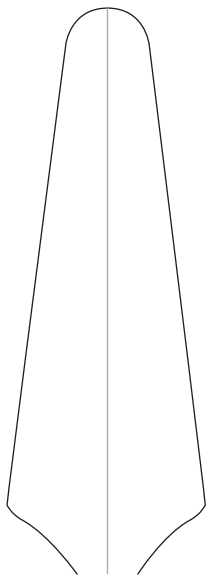

I **J150160**
23,5 cm - 9 1/4"

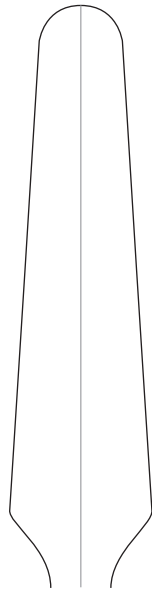

J **J150170**
23,5 cm - 9 1/4"

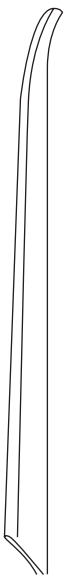

K **J150180**
23,5 cm - 9 1/4"

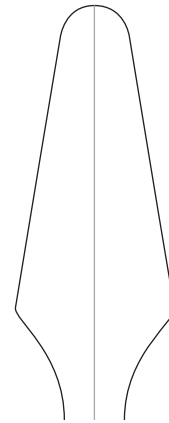

L **J150190**
20 cm - 8"

XI - Ortho-vertebrae
XI - Ortho-vertebrae
XI - Ortho-vertebrae

OLIVECRONA

7 x 9 mm **J151010** 
 11 x 13 mm **J151011**
 15 x 18 mm **J151012**
 18 x 22 mm **J151013**

7 x 9 mm **J151020**
 11 x 13 mm **J151021**
 15 x 18 mm **J151022** 
 18 x 22 mm **J151023**

12 mm **J151030**
 17 mm **J151031** 

Droite double
 Double straight
 Recta doble

Lame malléable
 Malleable spatula
 Espátula maleable

Concave
 Concave
 Cóncava

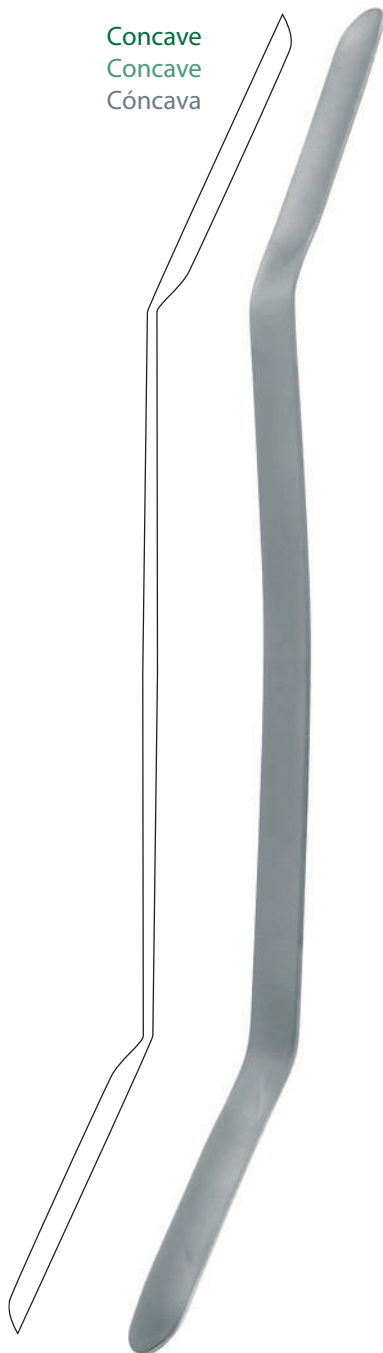

J151010
 18 cm - 7"

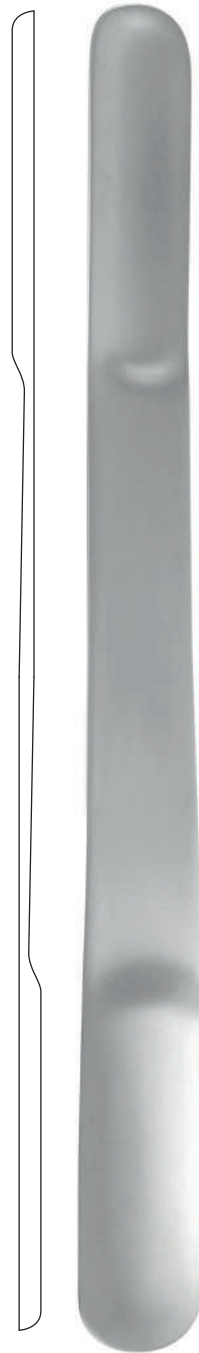

J151021
 18 cm - 7"



J151031
 20 cm - 8"

Spatules - Spatulas - Espátulas

HEIFETZ

AACHEN

- 7 x 8 mm J151040
- 10 x 11 mm J151041 
- 13 x 14 mm J151042
- 16 x 17 mm J151043
- 19 x 20 mm J151044
- 22 x 25 mm J151045

- 8 mm J151050
- 11 mm J151051 
- 14 mm J151052
- 17 mm J151053

- 7 + 8 mm J151060
- 10 + 11 mm J151061 

Lames malléables
Malleable spatulas
Espátulas maleables



J151041
20 cm - 8"

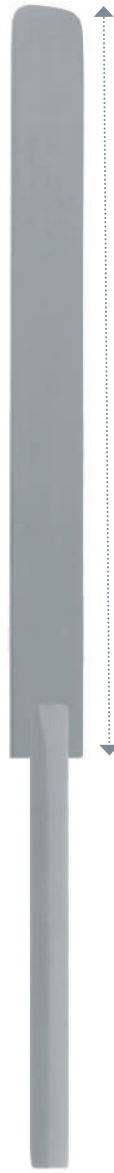

J151051
15,5 cm - 6"



J151061
20 cm - 8"

LOVE

Écarteurs à nerf
Nerve retractors
Nervios separadores

7 mm



J152001
7 mm
19,5 cm - 8"

7 mm



J152002
7 mm
19,5 cm - 8"

45°

90°

7 mm

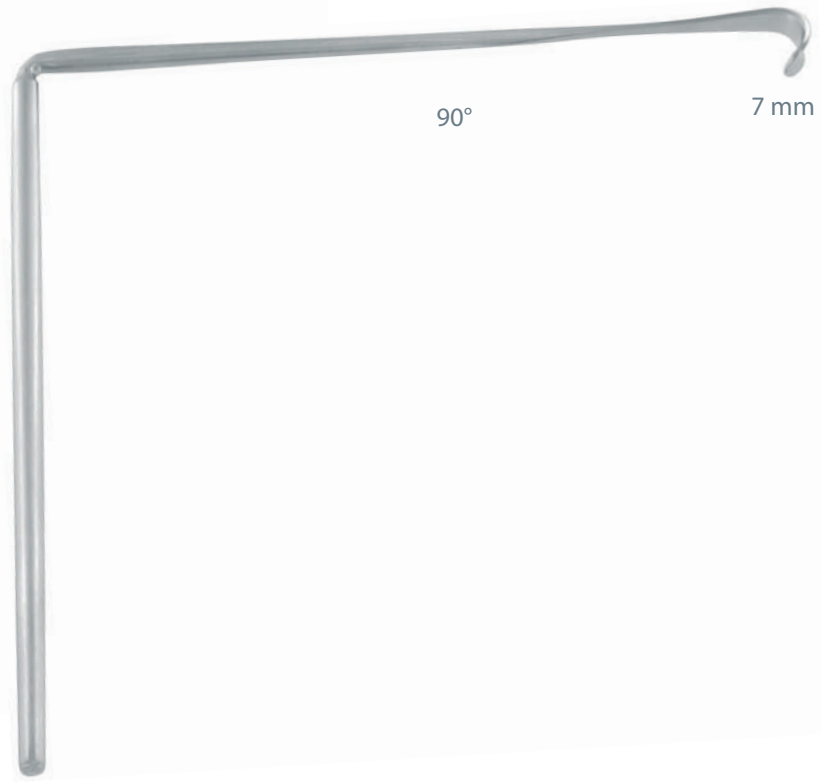

J152003
7 mm
19,5 cm - 8"

Écarteurs - Retractors - Separadores

LOVE

4 mm



J152000
21 cm - 8 1/4"

CASPAR

4 mm **J152204**

6 mm **J152206** 

8 mm **J152208**

10 mm **J152210**

Ecarteurs à nerf
Nerve retractors
Nervios separadores

J152206
24 cm - 9 1/2"

TAYLOR

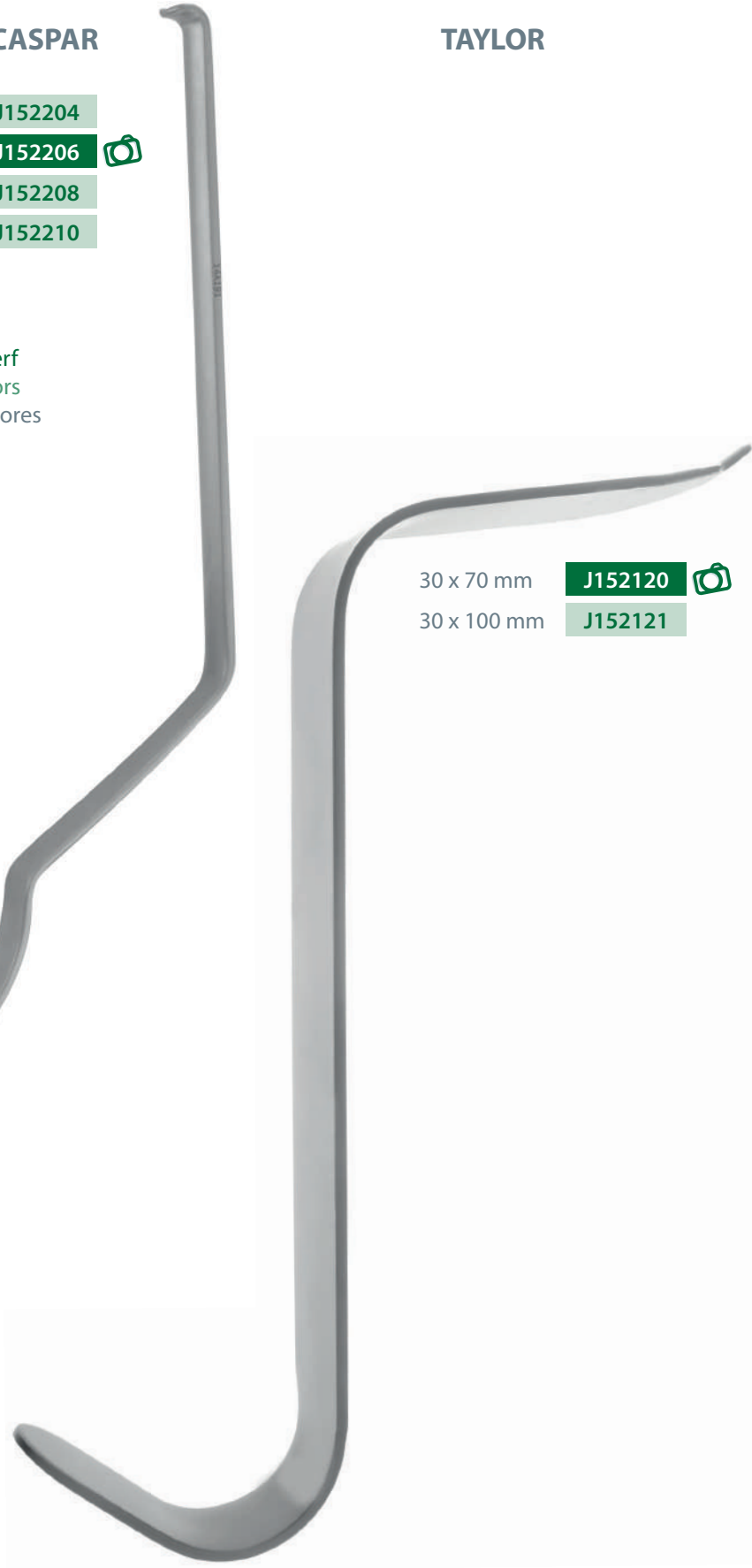

30 x 70 mm **J152120** 

30 x 100 mm **J152121**

J152120
17 cm - 6 3/4"



HOLSHER

Courbe
Curved
Curvo

7 mm **J152100** 
9 mm **J152101**

Coudé
Angled
Angulado

8 mm **J152110**
13 mm **J152111** 



J152100
24 cm - 9 1/2"



J152111
20 cm - 8"

HESS

90 mm

90 x 3 mm **J152303**
90 x 5 mm **J152305** 
90 x 7 mm **J152307**



J152305
18,5 cm - 7 1/4"

XI - Ortho-vertebre
XI - Ortho-vertebrae
XI - Ortho-vertebra

DOYEN

Perfateur initial - Initial drill - Perforador inicial



DOYEN



CLOVIS VINCENT



DOYEN (COURONNE DE TRÉPAN)



11 cm - 4^{1/4}"



Perfateur seul
Drill only
Perforador sólo

J16010

29 cm - 11^{1/3}"

HUDSON



J161010

ø 9 mm



J161020

ø 14 mm



J161030

ø 16 mm



J161040

ø 22 mm

CUSHING



J161050

ø 14 mm

Rallonge
Extension piece
Pieza alargadera

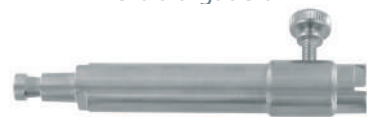

J161060

McKENZIE



J161080

ø 13 mm



J161090

ø 2 mm

ERRICO



J161100

ø 16 mm

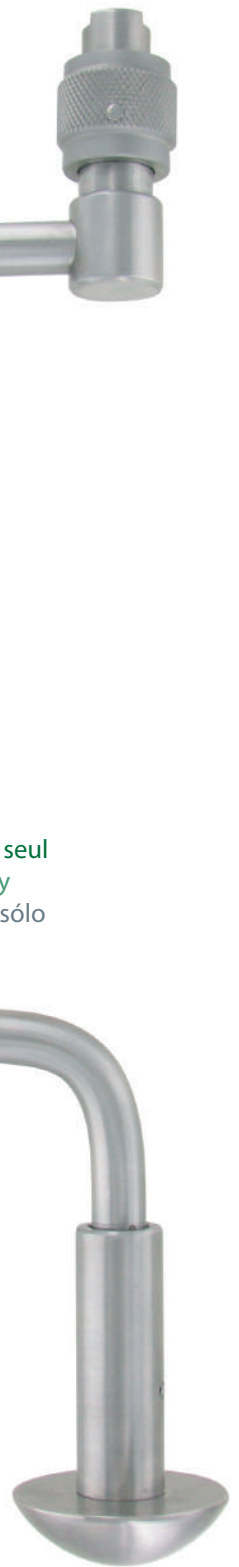

Perforateur seul
Drill only
Perforador sólo

J161000
29 cm - 11^{1/3}"

Pinces rongeurs - Rongeurs Forceps - Pinzas para laminectomía



Largeur de mors
 Width of jaw
 Anchura de boca

Longueur tige
 Length of shaft
 Largo del tallo

Droite
 Straight
 Recta

Vers le haut
 Upward
 Hacia arriba

Vers le bas
 Downward
 Hacia abajo

CUSHING

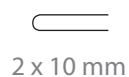

2 x 10 mm

13 cm - 5¹/₈"

15 cm - 6"

18 cm - 7"

23 cm - 9"

28 cm - 11"

J17001

J17002

J17003

J170040

J170041

J170042

J17005

J17006

J17007

J170043

J170044

-

J170046

J170047

-

LOVE-GRUENWALD



3 x 10 mm

13 cm - 5¹/₈"

15 cm - 6"

18 cm - 7"

23 cm - 9"

28 cm - 11"

J17010

J17012

J17015

J170160

J170161

J170162

J17020

J17025

J17035

J170163

J170164

-

J170166

J170167

-

SPURLING

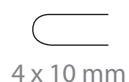

4 x 10 mm

13 cm - 5¹/₈"

15 cm - 6"

18 cm - 7"

23 cm - 9"

28 cm - 11"

J17045

J17050

J17055

J170560

J170561

J170562

J17060

J17065

J17070

J170563

J170564

-

J170566

J170567

-

CASPAR

Mors fenêtrés et dentelés
Serrated and fenestrated jaws
Serrado con ventana bocas

16 cm - 6^{1/4}"



J170919



Largeur de mors Width of jaw Anchura de boca	Longueur tige Shaft length Largo del tallo	Droite Straight Recta	Vers le haut Upward Hacia arriba	Vers le bas Downward Hacia abajo
----------------------------------------------------	--------------------------------------------------	-----------------------------	----------------------------------------	----------------------------------------

2 x 12 mm	14 cm - 5 ^{1/2} "	J170910	J170911	-
	16 cm - 6 ^{1/4} "	J170913	J170914	-
	18,5 cm - 7 ^{1/4} "	J1709330	-	-
	23 cm - 9"	J1709341	-	-
	28 cm - 11"	J1709342	-	-
3 x 12 mm	14 cm - 5 ^{1/2} "	J170916	J170917	-
	16 cm - 6 ^{1/4} "	J170919	J170920	J170921
	18,5 cm - 7 ^{1/4} "	J1709333	J1709334	J1709335
	23 cm - 9"	J1709343	-	-
	28 cm - 11"	J1709344	-	-
4 x 14 mm	14 cm - 5 ^{1/2} "	J170922	J170923	-
	16 cm - 6 ^{1/4} "	J170925	J170926	J170927
	18,5 cm - 7 ^{1/4} "	J1709336	J1709337	J1709338
	23 cm - 9"	J1709345	-	-
	28 cm - 11"	J1709346	-	-
5 x 14 mm	14 cm - 5 ^{1/2} "	J170928	J170929	-
	16 cm - 6 ^{1/4} "	J170931	J170932	-
	18,5 cm - 7 ^{1/4} "	J1709339	J1709340	-
	23 cm - 9"	J1709347	-	-
	28 cm - 11"	J1709348	-	-

CASPAR



J1709380

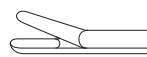



Largeur de mors
Width of jaw
Anchura de boca

Longueur tige
Shaft length
Largo del tallo

Droite
Straight
Recta

Vers le haut
Upward
Hacia arriba

Vers le bas
Downward
Hacia abajo

	2 x 15 mm	15,5 cm - 6 ^{1/8} " 	J1709380	J1709381	J1709382
	3 x 15 mm	15,5 cm - 6 ^{1/8} "	J1709383	J1709384	J1709385
	4 x 15 mm	15,5 cm - 6 ^{1/8} "	J1709386	J1709387	J1709388
	5 x 15 mm	15,5 cm - 6 ^{1/8} "	J1709389	-	-

FERRIS-SMITH-CUSHING

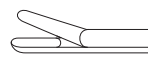

Largeur de mors
Width of jaw
Anchura de boca

Longueur tige
Shaft length
Largo del tallo

Droite
Straight
Recta

Vers le haut
Upward
Hacia arriba

Vers le bas
Downward
Hacia abajo

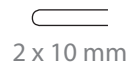

2 x 10 mm

18 cm - 7"



J170750

J170751

J170752



3 x 10 mm

18 cm - 7"

J17080

J17085

J170860



4 x 10 mm

18 cm - 7"

J17090

J170898

J170899

WEIL-BLAKESLEY



J170903

Largeur de mors
Width of jaw
Anchura de boca

Longueur tige
Shaft length
Largo del tallo

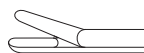

Droite
Straight
Recta



Vers le haut
Upward
Hacia arriba

3,0 x 10 mm

12 cm - 4^{3/4}"

J170901

J170902

3,5 x 10 mm

12 cm - 4^{3/4}"



J170903

J170904

4,5 x 10 mm

12 cm - 4^{3/4}"

J170905

J170906

5,0 x 10 mm

12 cm - 4^{3/4}"

J170907

J170908

6,0 x 10 mm

12 cm - 4^{3/4}"

J170909

-

FERRIS SMITH KERRISSON

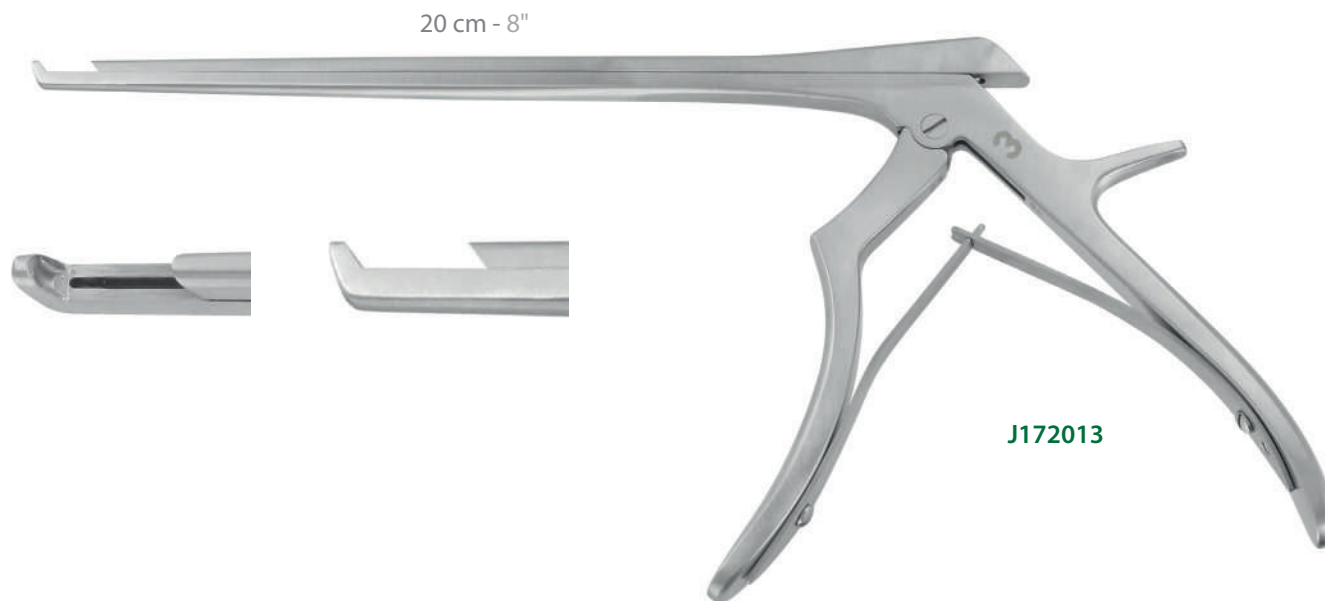

40° Haut / 40° Upward / 40° Arriba

Largeur de mors Width of jaw Anchura de boca	Longueur tige Shaft length - Largo del tallo				
	18 cm - 7"	20 cm - 8"	23 cm - 9"	25 cm - 10"	28 cm - 11"
1 mm	J171170	J172011	-	-	-
2 mm	J17118	J172012	J172312	J172512	-
3 mm	J17120	J172013	J172313	J172513	J172813
4 mm	J17130	J172014	J172314	J172514	J172814
5 mm	J17140	J172015	J172315	J172515	J172815
6 mm	-	J172016	-	-	-



40° Haut talon fin / 40° Upward thin foot plate / 40° Arriba talón fino

Largeur de mors Width of jaw Anchura de boca	Longueur tige Shaft length - Largo del tallo				
	18 cm - 7"	20 cm - 8"	23 cm - 9"	25 cm - 10"	28 cm - 11"
1 mm	J171170T	J172011T	-	-	-
2 mm	J171180T	J172012T	J172312T	J172512T	-
3 mm	J171200T	J172013T	J172313T	J172513T	J172813T
4 mm	J171300T	J172014T	J172314T	J172514T	J172814T
5 mm	J171400T	J172015T	J172315T	J172515T	J172815T
6 mm	-	J172016T	-	-	-

T: Talon fin - Thin footplate - Talón fino

FERRIS SMITH KERRISSON

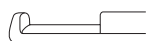
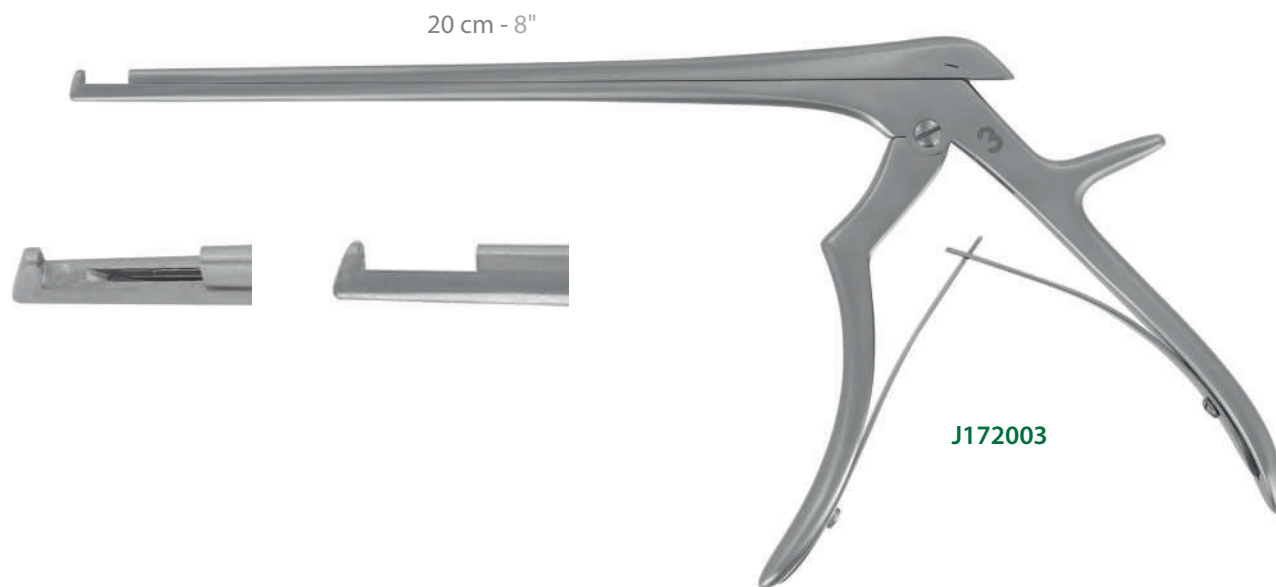

90° Haut / 90° Upward / 90° Arriba

Largeur de mors Width of jaw Anchura de boca	Longueur tige Shaft length - Largo del tallo		
	18 cm - 7"	20 cm - 8"	28 cm - 11"
	1 mm	J170940	J172001
2 mm	J17095	J172002	-
3 mm	J17100	J172003	J172803
4 mm	J17110	J172004	J172804
5 mm	J17115	J172005	J172805

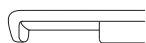

90° Bas / 90° Downward / 90° Abajo

Largeur de mors Width of jaw Anchura de boca	Longueur tige Shaft length - Largo del tallo	
	18 cm - 7"	20 cm - 8"
	1 mm	J171821
2 mm	J171822	J172022
3 mm	J171823	J172023
4 mm	J171824	J172024
5 mm	J171825	J172025



40° Bas / 40° Downward / 40° Abajo

Largeur de mors Width of jaw Anchura de boca	Longueur tige Shaft length - Largo del tallo	
	18 cm - 7"	23 cm - 9"
	1 mm	J171831
2 mm	J171832	-
3 mm	J171833	J172333
4 mm	J171834	J172334
5 mm	J171835	J172335

FERRIS SMITH KERRISSON

Avec éjecteur - With ejector - Con Eyector

20 cm - 8"



J172015E



40° Haut / 40° Upward / 40° Arriba

Largeur de mors Width of jaw Anchura de boca	Longueur tige Shaft length - Largo del tallo	
	18 cm - 7"	20 cm - 8"
1 mm	J171170E	J172011E
2 mm	J17118E	J172012E
3 mm	J17120E	J172013E
4 mm	J17130E	J172014E
5 mm	J17140E	J172015E 
6 mm	-	J172016E

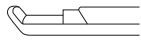

40° Haut talon fin / 40° Upward thin foot plate 40° Arriba talón fino

Largeur de mors Width of jaw Anchura de boca	Longueur tige Shaft length - Largo del tallo	
	18 cm - 7"	20 cm - 8"
1 mm	J171170ET	J172011ET
2 mm	J171180ET	J172012ET
3 mm	J171200ET	J172013ET
4 mm	J171300ET	J172014ET
5 mm	J171400ET	J172015ET
6 mm	-	J172016ET

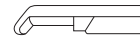

40° Bas talon fin / 40° Downward thin foot plate / 40° Abajo talón fino

Largeur de mors Width of jaw Anchura de boca	Longueur tige Shaft length - Largo del tallo	
	18 cm - 7"	23 cm - 9"
1 mm	J171831ET	-
2 mm	J171832ET	-
3 mm	J171833ET	J172333ET
4 mm	J171834ET	J172334ET
5 mm	J171835ET	J172335ET

E : Ejecteur - Ejector - Eyector
T : Talon fin - Thin footplate - Talón fino

FERRIS SMITH KERRISSON

Revêtement céramique noir - Black ceramic coating - Revestimiento de ceramica negro

20 cm - 8"



J172012TB

90° Haut / 90° Upward / 90° Arriba

Largeur de mors
Width of jaw
Anchura de boca

Longueur tige
Shaft length - Largo del tallo

	18 cm - 7"	20 cm - 8"
1 mm	J170940B	-
2 mm	J17095B	-
3 mm	J17100B	J172003B
4 mm	J17110B	J172004B
5 mm	J17115B	J172005B

40° Haut / 40° Upward / 40° Arriba

Largeur de mors
Width of jaw
Anchura de boca

Longueur tige
Shaft length - Largo del tallo

	18 cm - 7"	20 cm - 8"	25 cm - 10"
1 mm	J171170B	J172011B	-
2 mm	J17118B	J172012B	J172512B
3 mm	J17120B	J172013B	J172513B
4 mm	J17130B	J172014B	J172514B
5 mm	J17140B	J172015B	J172515B

40° Haut talon fin / 40° Upward thin foot plate 40° Arriba talón fino

Largeur de mors
Width of jaw
Anchura de boca

Longueur tige
Shaft length - Largo del tallo

	18 cm - 7"	20 cm - 8"	25 cm - 10"
1 mm	J171170TB	J172011TB	-
2 mm	J171180TB	J172012TB	J172512TB
3 mm	J171200TB	J172013TB	J172513TB
4 mm	J171300TB	J172014TB	J172514TB
5 mm	J171400TB	J172015TB	J172515TB

T: Talon fin - Thin footplate - Talón fino

B: Revêtement céramique noir - Black ceramic coating - Revestimiento de ceramica negro

FERRIS SMITH KERRISSON

Démontable - Detachable - Desmontable
Avec éjecteur - With ejector - Con Ejector

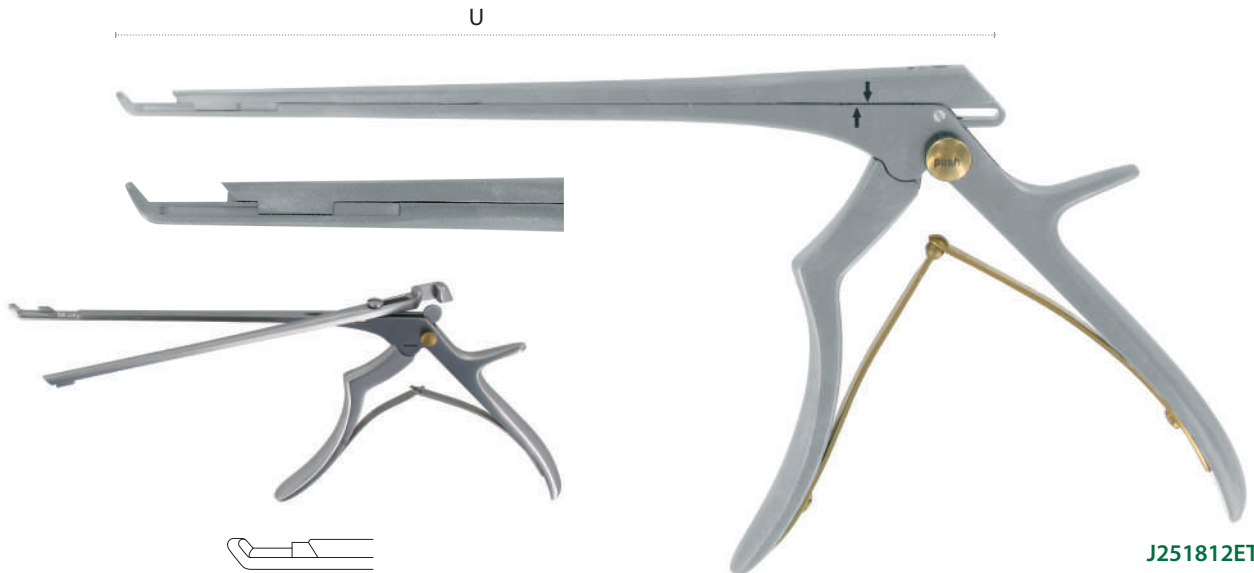

J251812ET

U : 180 mm - 7"

40° Haut / 40° Upward / 40° Arriba

Largeur de mors Width of jaw Anchura de boca	Longueur tige Shaft length - Largo del tallo			
	18 cm - 7"	20 cm - 8"	23 cm - 9"	28 cm - 11"
1 mm	J251811E	J252011E	J252311E	J252811E
2 mm	J251812E	J252012E	J252312E	J252812E
3 mm	J251813E	J252013E	J252313E	J252813E
4 mm	J251814E	J252014E	J252314E	J252814E
5 mm	J251815E	J252015E	J252315E	J252815E

40° Haut talon fin / 40° Upward thin foot plate / 40° Arriba talón fino

Largeur de mors Width of jaw Anchura de boca	Longueur tige Shaft length - Largo del tallo			
	18 cm - 7"	20 cm - 8"	23 cm - 9"	28 cm - 11"
1 mm	J251811ET	J252011ET	J252311ET	J252811ET
2 mm	J251812ET	J252012ET	J252312ET	J252812ET
3 mm	J251813ET	J252013ET	J252313ET	J252813ET
4 mm	J251814ET	J252014ET	J252314ET	J252814ET
5 mm	J251815ET	J252015ET	J252315ET	J252815ET

T: Talon fin - Thin footplate - Talón fino

XI - Ortho-vertebre
XI - Ortho-vertebrae
XI - Ortho-vertebra

FERRIS SMITH KERRISSON

Démontable - Detachable - Desmontable
Avec éjecteur - With ejector - Con Ejector

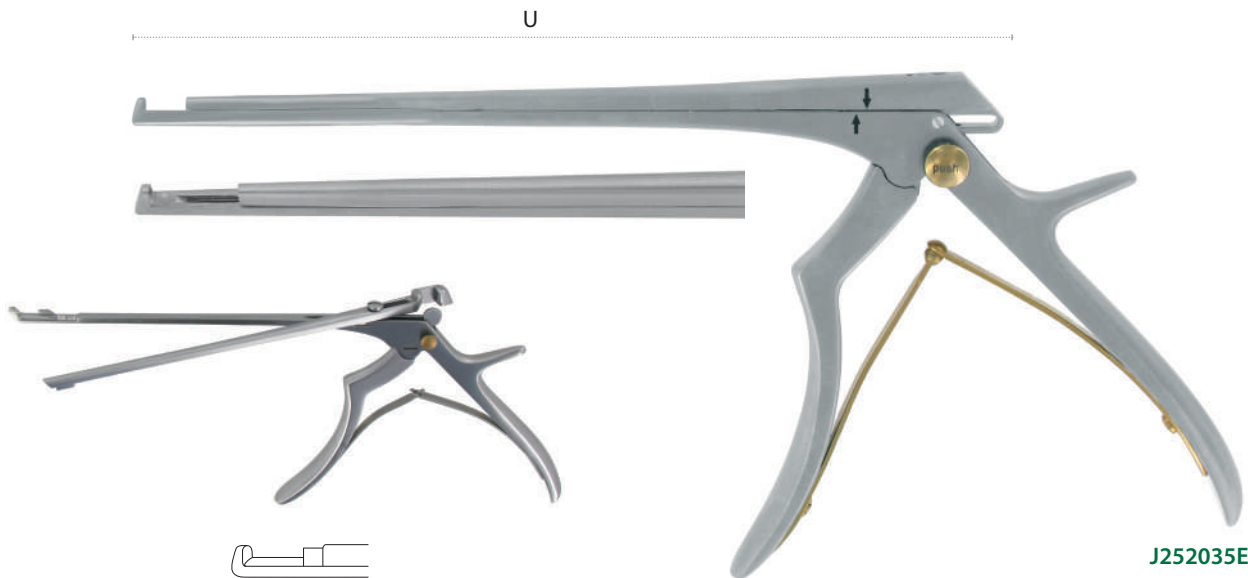

J252035E

U : 200 mm - 8"

90° Haut / 90° Upward / 90° Arriba

Largeur de mors Width of jaw Anchura de boca	Longueur tige Shaft length - Largo del tallo			
	18 cm - 7"	20 cm - 8"	23 cm - 9"	28 cm - 11"
1 mm	J251831E	J252031E	J252331E	J252831E
2 mm	J251832E	J252032E	J252332E	J252832E
3 mm	J251833E	J252033E	J252333E	J252833E
4 mm	J251834E	J252034E	J252334E	J252834E
5 mm	J251835E	J252035E	J252335E	J252835E

90° Haut talon fin / 90° Upward thin foot plate / 90° Arriba talón fino

Largeur de mors Width of jaw Anchura de boca	Longueur tige Shaft length - Largo del tallo			
	18 cm - 7"	20 cm - 8"	23 cm - 9"	28 cm - 11"
1 mm	J251831ET	J252031ET	J252331ET	J252831ET
2 mm	J251832ET	J252032ET	J252332ET	J252832ET
3 mm	J251833ET	J252033ET	J252333ET	J252833ET
4 mm	J251834ET	J252034ET	J252334ET	J252834ET
5 mm	J251835ET	J252035ET	J252335ET	J252835ET

T: Talon fin : seulement pour usage délicat – petites portions d'os ou tissus mous
T : Thin footplate : for delicate use only – small portion of bones or soft tissues
T : Talón fino : solo para uso delicado – pequeña porción de huesos o tejidos blandos

U : Longueur utile
U : Working length
U : Longitud útil

XI - Ortho-vertebrae
XI - Ortho-vertebrae
XI - Ortho-vertebrae

FERRIS SMITH KERRISSON

Démontable - Detachable - Desmontable
Avec éjecteur - With ejector - Con Ejector

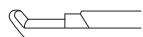

40° Haut / 40° Upward / 40° Arriba

Largeur de mors Width of jaw Anchura de boca	Longueur tige Shaft length - Largo del tallo			
	18 cm - 7"	20 cm - 8"	23 cm - 9"	28 cm - 11"
	1 mm	J201811E	J202011E	J202311E
2 mm	J201812E	J202012E	J202312E	J202812E
3 mm	 J201813E	J202013E	J202313E	J202813E
4 mm	J201814E	J202014E	J202314E	J202814E
5 mm	J201815E	J202015E	J202315E	J202815E
6 mm	-	J202016E	-	-



90° Haut / 90° Upward / 40° Arriba

Largeur de mors Width of jaw Anchura de boca	Tige Shaft - Tallo
	18 cm - 7"
	1 mm
2 mm	J201832E
3 mm	J201833E
4 mm	J201834E
5 mm	J201835E

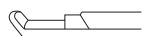

40° Haut talon fin / 40° Upward thin foot plate 40° Arriba talón fino

Largeur de mors Width of jaw Anchura de boca	Longueur tige Shaft length - Largo del tallo		
	18 cm - 7"	20 cm - 8"	23 cm - 9"
	1 mm	J201811ET	J202011ET
2 mm	J201812ET	J202012ET	J202312ET
3 mm	J201813ET	J202013ET	J202313ET
4 mm	J201814ET	J202014ET	J202314ET
5 mm	J201815ET	J202015ET	J202315ET



40° Bas / 40° Downward / 40° Abajo

Largeur de mors Width of jaw Anchura de boca	Longueur tige Shaft length - Largo del tallo	
	18 cm - 7"	23 cm - 9"
	1 mm	-
2 mm	-	-
3 mm	J201823E	J202323E
4 mm	J201824E	J202324E
5 mm	J201825E	J202325E

E : Ejecteur - Ejector - Ejector
T : Talon fin - Thin footplate - Talón fino

FERRIS SMITH KERRISSON

Démontable - Detachable - Desmontable
 Avec éjecteur - With ejector - Con Eyector
 Revêtement céramique noir - Black ceramic coating - Revestimiento de ceramica negro

20 cm - 8"



J202013EB

40° Haut / 40° Upward / 40° Arriba

Largeur de mors
 Width of jaw
 Anchura de boca

Longueur tige
 Shaft length - Largo del tallo

	18 cm - 7"	20 cm - 8"	23 cm - 9"	28 cm - 11"
1 mm	J201811EB	J202011EB	J202311EB	J202811EB
2 mm	J201812EB	J202012EB	J202312EB	J202812EB
3 mm	J201813EB	J202013EB	J202313EB	J202813EB
4 mm	J201814EB	J202014EB	J202314EB	J202814EB
5 mm	J201815EB	J202015EB	J202315EB	J202815EB
6 mm	-	J202016EB	-	-



40° Haut talon fin / 40° Upward thin foot plate 40° Arriba talón fino

Largeur de mors
 Width of jaw
 Anchura de boca

Longueur tige
 Shaft length - Largo del tallo

	18 cm - 7"	20 cm - 8"	23 cm - 9"
1 mm	J201811ETB	J202011ETB	-
2 mm	J201812ETB	J202012ETB	J202312ETB
3 mm	J201813ETB	J202013ETB	J202313ETB
4 mm	J201814ETB	J202014ETB	J202314ETB
5 mm	J201815ETB	J202015ETB	J202315ETB

E: Ejecteur - Ejector - Eyector

T: Talon fin - Thin footplate - Talón fino

B: Revêtement céramique noir - Black ceramic coating - Revestimiento de ceramica negro

O.R.L. ouvre-bouche - E.N.T. mouth gag - O.R.L. abre-boca

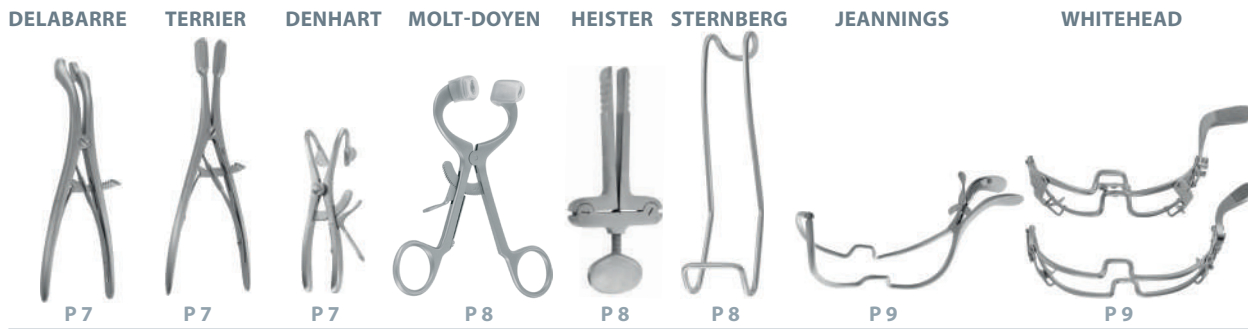

O.R.L. dilatateurs - E.N.T. dilators - O.R.L. dilatadores

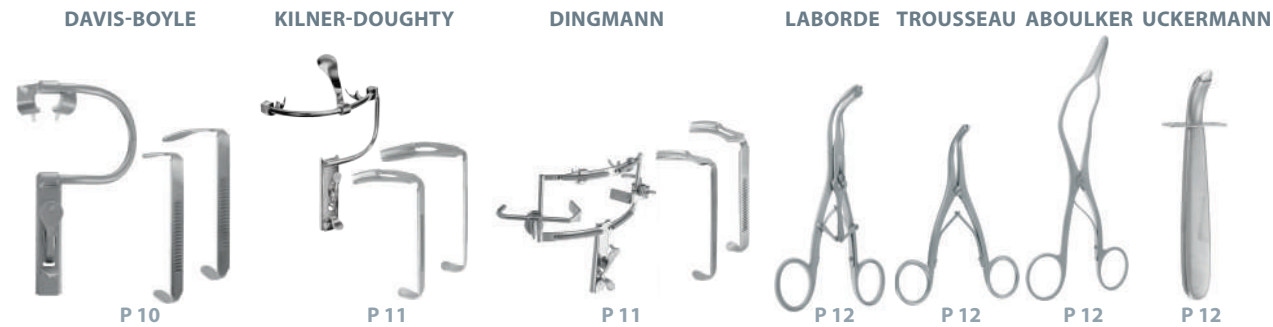

O.R.L. pinces à préhension - E.N.T. grasping forceps - O.R.L. pinzas a presión

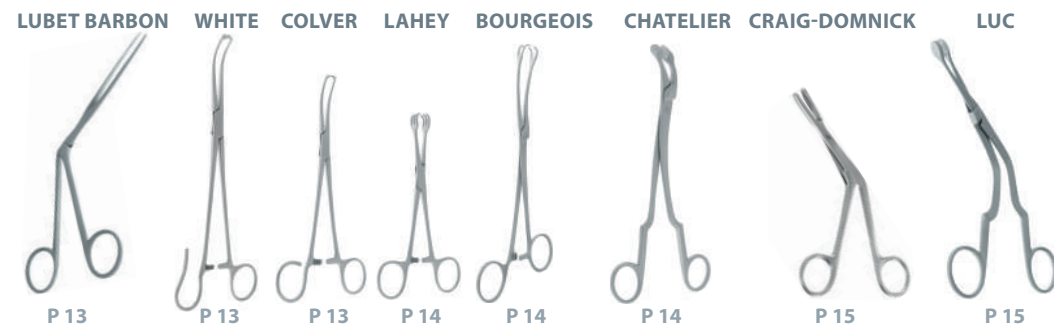

O.R.L. speculums - E.N.T. specula - O.R.L. espéculos

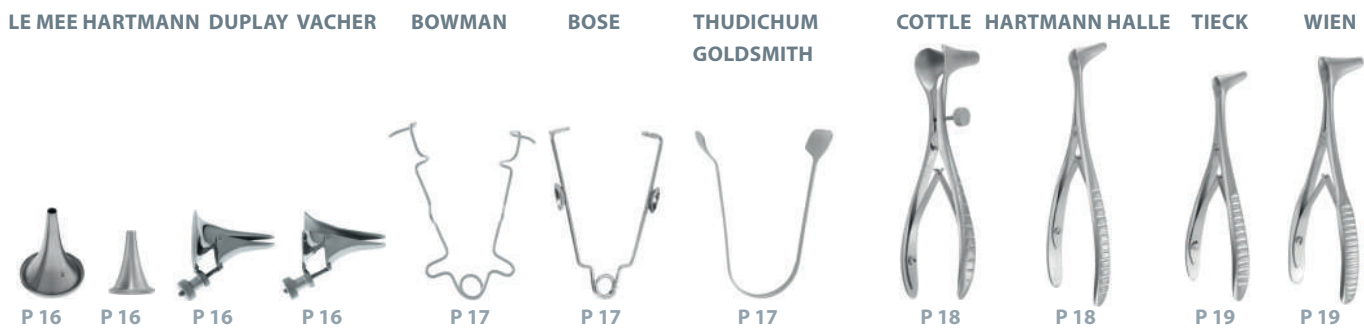

O.R.L. Serre-noeuds - E.N.T. snares - O.R.L. cierra nudos

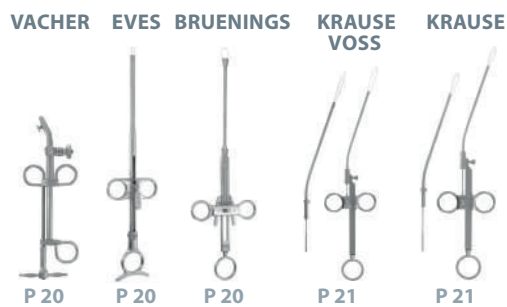

O.R.L. aiguilles à paracentèse - E.N.T. paracentesis needles - O.R.L. agujas para paracentesis



O.R.L. couteaux à végétations - E.N.T. adenoids knives - O.R.L. cuchillos para vegetaciones



O.R.L. couteaux spatules - E.N.T. knives spatula - O.R.L. bistouris espátulas

KOCHER RUAULT ABRAHAM



P 25 P 25 P 25

O.R.L. amygdalotome - E.N.T. tonsillotome - O.R.L. amigdalotomo

SLUDDER-BALLENGER



P 26 P 26

O.R.L. emporte pièces - E.N.T. punch forceps - O.R.L. sacabocados

KERRISSON CITELLI TAKAHASHI HARTMANN STRUYCKEN HAJEK GRUENWALD-HENKE JANSEN



P 27 P 27 P 28 P 28 P 28 P 28 P 28 P 28 P 29 P 29

O.R.L. pinces à polypes - E.N.T. polypus forceps - O.R.L. pinzas para pólipos

HARTMANN HARTMANN CITELLI HARTMANN

O.R.L. pinces pour oreilles - E.N.T. ear forceps - O.R.L. pinzas para orejas

HARTMANN HARTMANN WEINGARTNER



P 30 P 30 P 30



P 31 P 31 P 31

O.R.L. pinces pour oreilles - E.N.T. ear forceps - O.R.L. pinzas para orejas

BUCK QUIRE HARTMANN

O.R.L. micro instruments - E.N.T. micro instruments - O.R.L. micro instrumentos

BELLUCI



P 32 P 32 P 32



P 33 P 33

O.R.L. pinces et cisaille - E.N.T. forceps and shear - O.R.L. pinzas y cizalla

MOORE ASCH RUBIN



P 34 P 34 P 34

O.R.L. pinces à repositionner - E.N.T. reposition forceps - O.R.L. pinzas para reposicionar

O.R.L. pinces pour oesophagoscopie - E.N.T. forceps for oesophagoscopy - O.R.L. pinzas para esofagoscopia

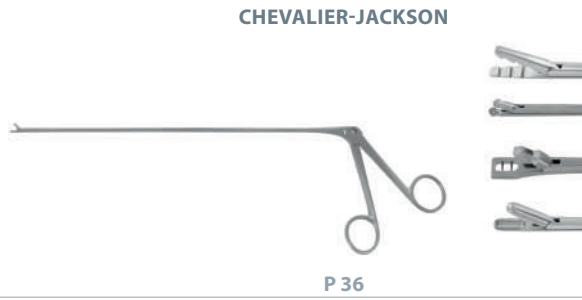

O.R.L. burins et gouges - E.N.T. chisels and gouges - O.R.L. cinceles y gubias O.R.L. ostéotomes - E.N.T. osteotome - O.R.L. osteotomos



O.R.L. gouges - E.N.T. gouges - O.R.L. gubias

O.R.L. rugines - E.N.T. raspatories - O.R.L. raspadores



O.R.L. râpes - E.N.T. rasps - O.R.L. raspas



O.R.L. crochets - E.N.T. hooks - O.R.L. ganchos



O.R.L. écarteurs - E.N.T. retractors - O.R.L. separadores

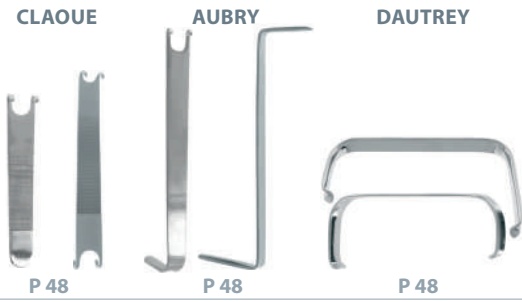

O.R.L. écarteurs et crochets - E.N.T. retractors and hooks - O.R.L. separadores y ganchos

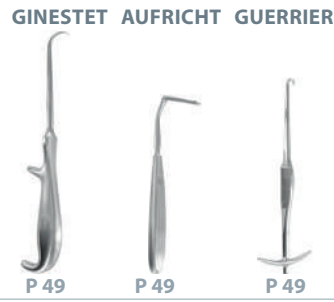

O.R.L. éleveurs - E.N.T. elevator - O.R.L. elevadores

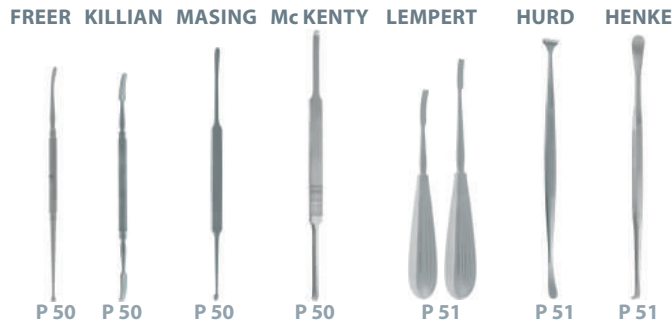

O.R.L. Instruments de Joseph - E.N.T. Joseph's instruments - O.R.L. Instrumentos de Joseph



O.R.L. maillets et curettes - E.N.T. mallets and curettes - O.R.L. mazos y curetas



O.R.L. curettes - E.N.T. curettes - O.R.L. mazos y curetas

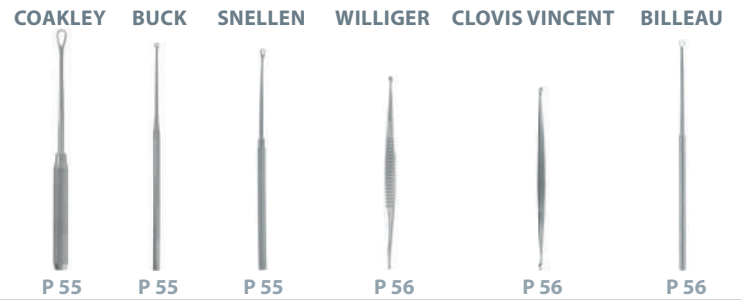

O.R.L. canules aspiratrices - E.N.T. suction tubes - O.R.L. canulas aspirantes

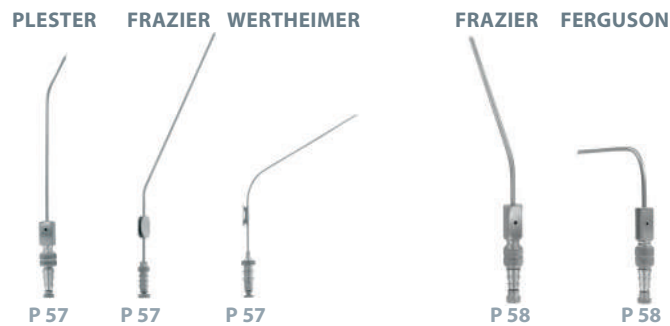

O.R.L. diapason - E.N.T. tuning forks - O.R.L. diapasones



Pinces à dissection ORL - ENT dissecting forceps - Pinzas para disección ORL

II - Dissection
II - Dissecting
II - Disección

TROELTSCH



P 38

POLITZER

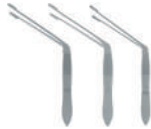

P 39

LUCAE



P 40

JANSEN LUCAE



P 40

Ciseaux ORL - ENT scissors - Tijeras ORL

III - Ciseaux
III - Scissors
III - Tijeras

JOSEPH



P 83

FOMON



P 83

HALLE



P 83

FOMON



P 84

COTTLE



P 84

HEYMANN



P 84

Encore plus d'instruments dédiés dans notre catalogue O.R.L.
Even more dedicated instruments in our E.N.T. catalog
Incluso más instrumentos dedicados en nuestro catálogo de O.R.L.

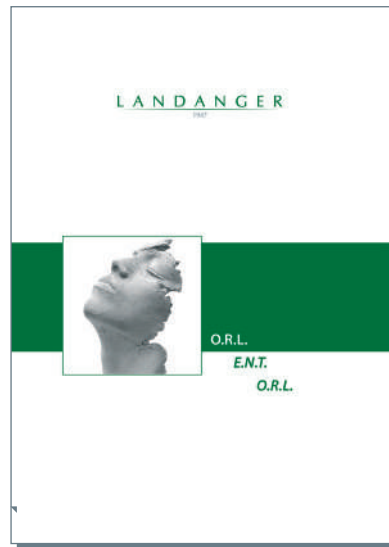

DELABARRE

TERRIER

DENHART



Mors droits
Straight jaws
Bocas rectas

I05020

21 cm - 8 1/4"



Mors coudés
Angled jaws
Bocas anguladas

I05010

20 cm - 8"



I05030

19 cm - 7 1/2"



I050410

13 cm - 5 1/8"



3/4

MOLT-DOYEN

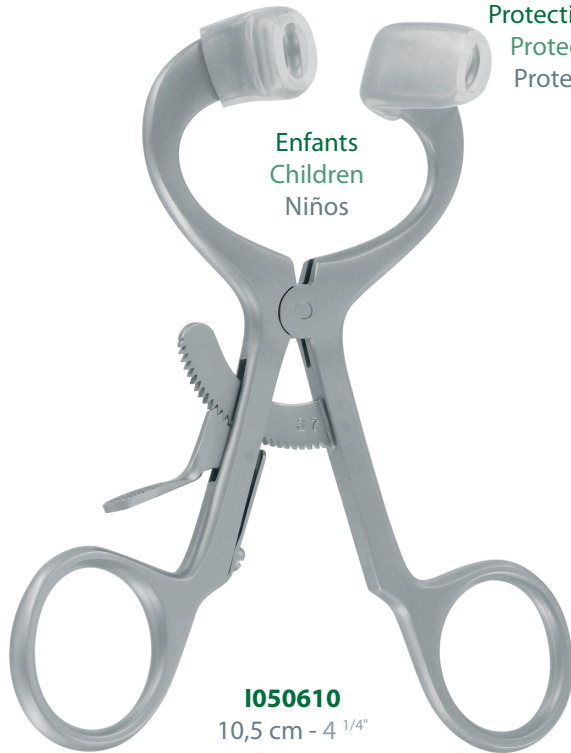

Enfants
Children
Niños

I050610

10,5 cm - 4 1/4"

Protections seules (paire)
Protection only (pair)
Protección sólo (par)

I050611

HEISTER



I05120

13 cm - 5"

STERNBERG



I051210

14 cm - 5 1/2"



Adultes
Adults
Adultos

I050620

14 cm - 4 1/2"

Protections seules (paire)
Protection only (pair)
Protección sólo (par)

I050621

JENNINGS

- 9 cm - 3 1/2" **I050690**
- 11 cm - 4 1/4" **I05070**
- 13 cm - 5" **I05080**
- 15 cm - 6" **I050810** 

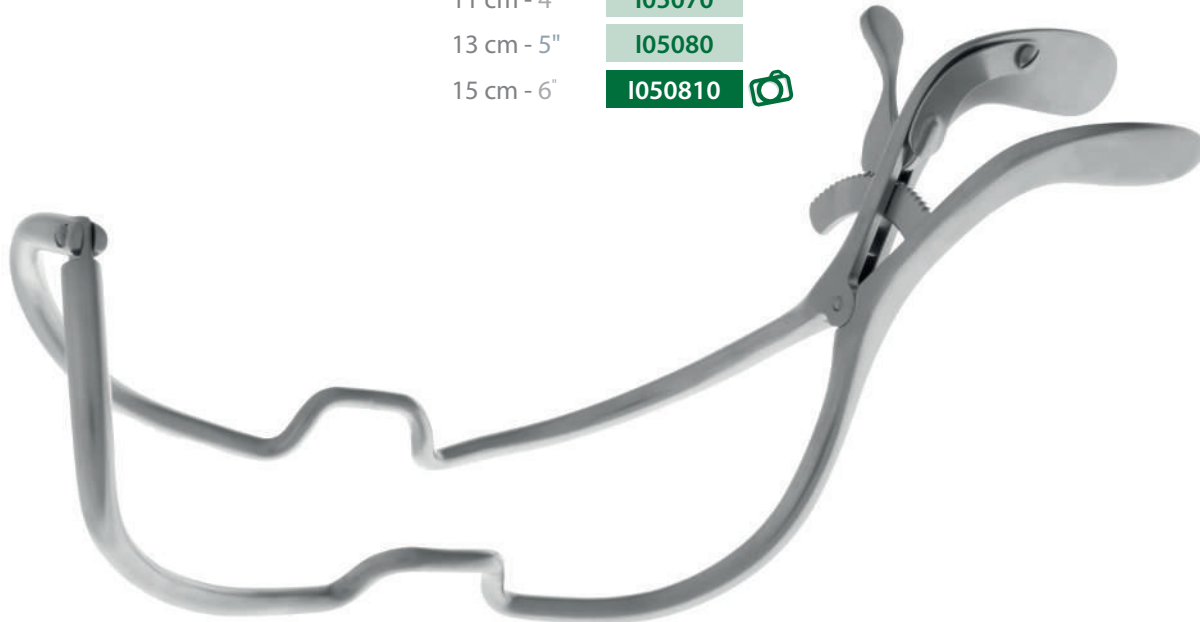

I050810
15 cm - 6"

WHITEHEAD

Avec abaisse langue
With tongue depressor
Con depresor de lengua

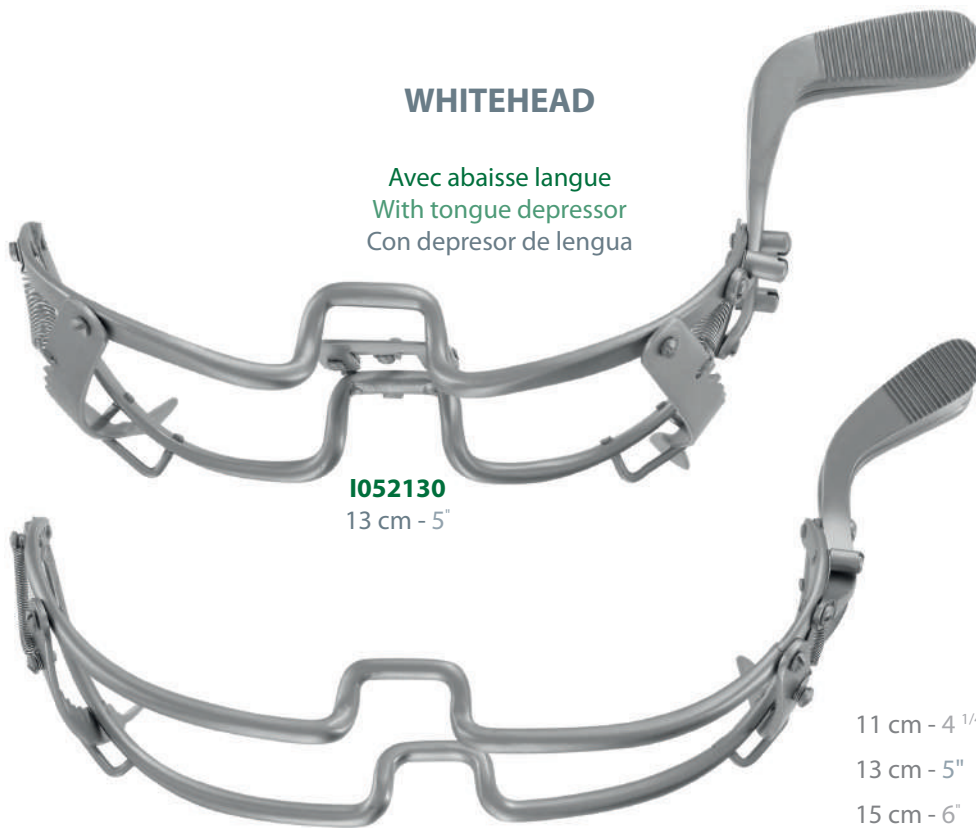

I052130
13 cm - 5"

I052110
13 cm - 5"

- 11 cm - 4 1/4" **I052100**
- 13 cm - 5" **I052110** 
- 15 cm - 6" **I052120**

DAVIS-BOYLE



I051320
15 cm - 6"

Ouvre-bouche
Mouth-gag
Mordaza de boca



Ouverture à gauche
Open on left
Abierta a la izquierda

Ouverture à droite
Open on right
Abierta a la derecha

I051320	I051319
I051322	I051321

Adulte
Adult
Adulto

Enfant
Child
Niño

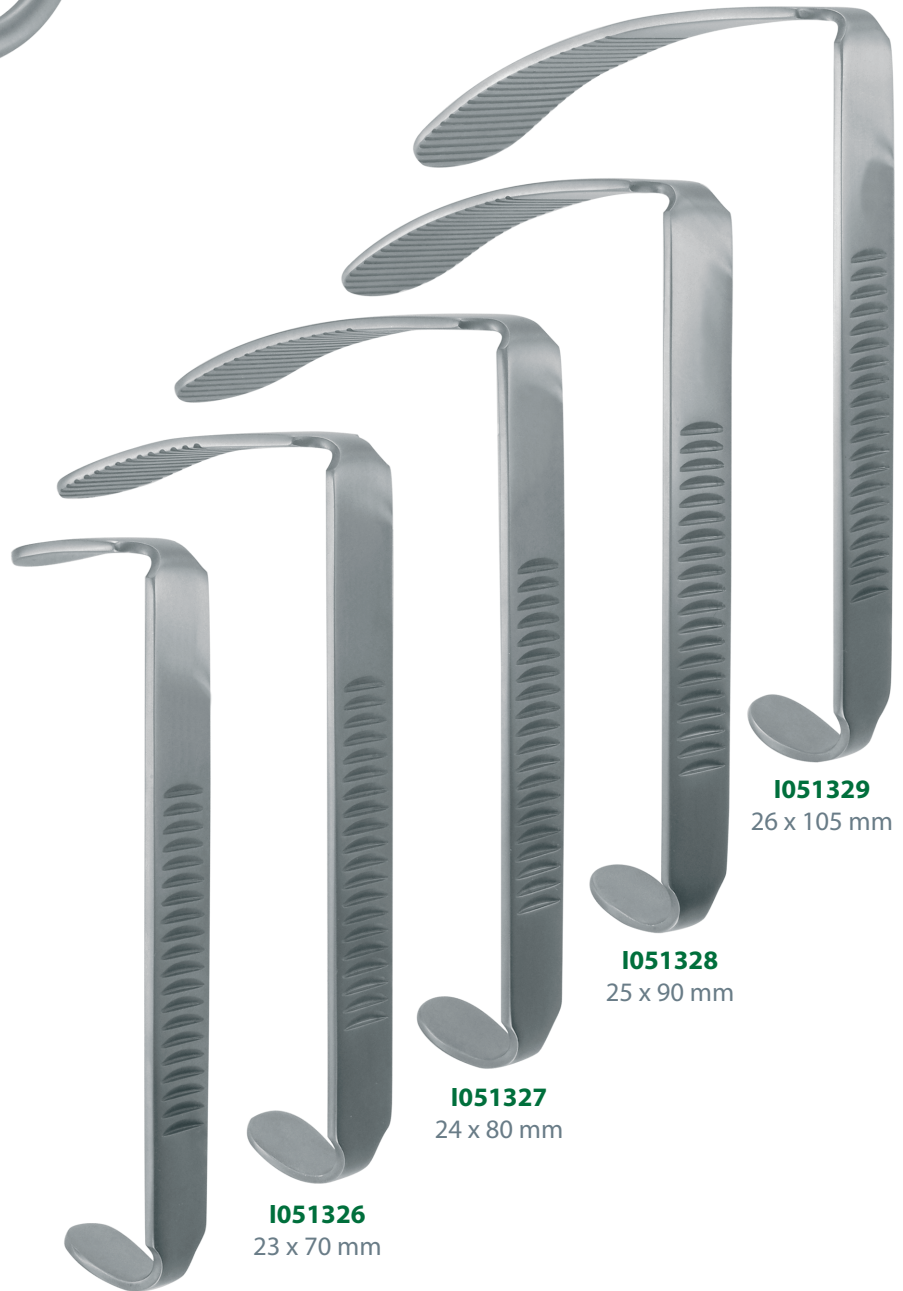

I051329
26 x 105 mm

I051328
25 x 90 mm

I051327
24 x 80 mm

I051326
23 x 70 mm

Protections seules (paire)
Protection only (pair)
Protección sólo (par)

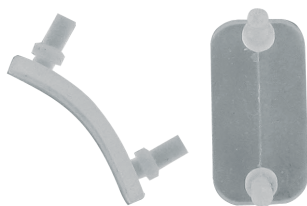

I051310
20 x 35 mm

I051325
20 x 35 mm



KILNER-DOUGHTY



I051410

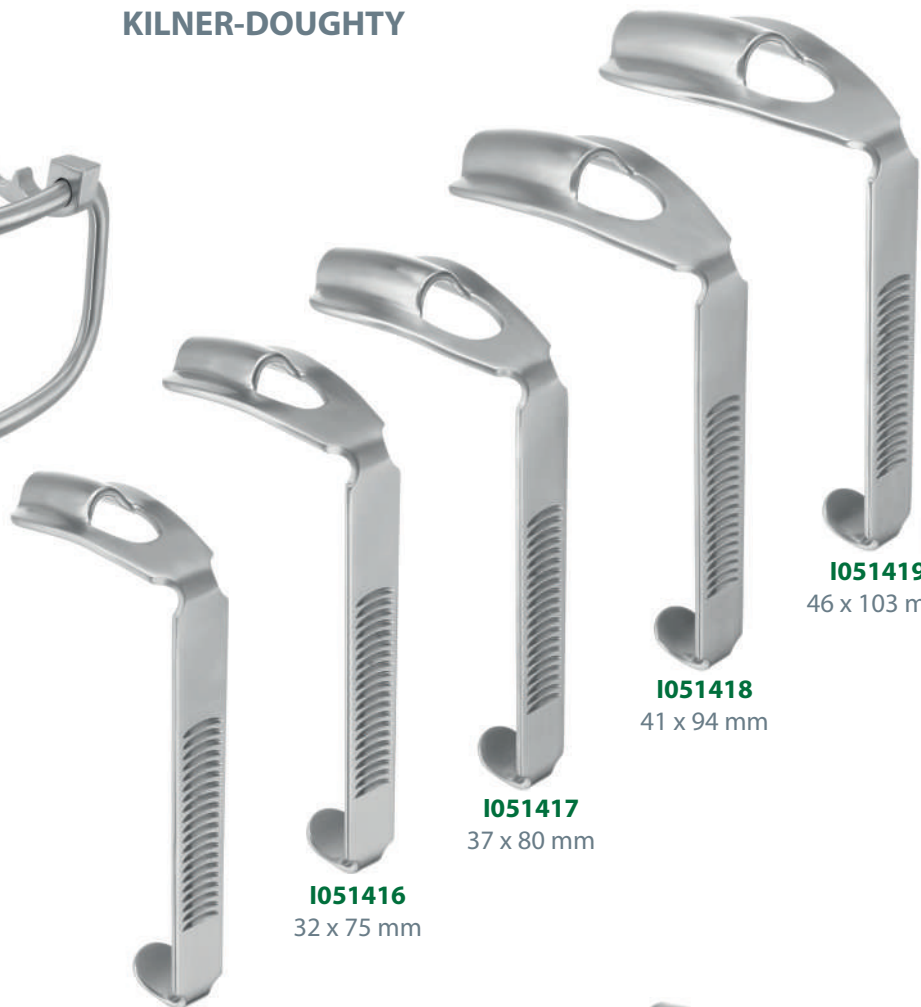

I051415
28 x 65 mm

I051416
32 x 75 mm

I051417
37 x 80 mm

I051418
41 x 94 mm

I051419
46 x 103 mm

DINGMANN



I051510



I051515
24 x 62 mm

I051516
28 x 65 mm

I051517
31 x 75 mm

XII - O.R.L.
XII - E.N.T.
XII - O.R.L.

LABORDE

12 cm - 4^{3/4}"

I10010

15 cm - 6"

I10015



TROUSSEAU

2 branches
2 mors
2 bocas

I10020

12 cm - 4^{3/4}"

ABOULKER

Enfants
Childrens
Niños

18 cm - 7"

I10022

8 mm

Adultes
Adults
Adultos

18 cm - 7"

I10024

10 mm



3 branches
3 mors
3 bocas

I10015

15 cm - 6"



UCKERMANN

ø 10 mm



1/1

I100300

13 cm - 5"



4/5

O.R.L. pinces à préhension - E.N.T. grasping forceps - O.R.L. pinzas a presión

LUBET BARBON

WHITE

COLVER

Sans griffes A griffes
 Without teeth With teeth
 Sin dientes Con dientes

21 cm - 8 1/4"



I15080

I15070

18 cm - 7"

I150810

23 cm - 9"

I150815



I15080

21 cm - 8 1/4"



I150815

23 cm - 9"

Courbe
 Curved
 Curva



I150820

19 cm - 7 1/2"



LAHEY

A goitre
For goiter
Para gocio



I150250
15 cm - 6"

BOURGEOIS

Anneaux décalés
Displaced ring
Anillos decalados



I15030
21 cm - 8 1/4"

CHATELIER

Enfants
Childrens
Niños

20 cm - 8" **I15020** 6 mm

Adultes
Adults
Adultos

22 cm - 8 3/4" **I15010** 10 mm

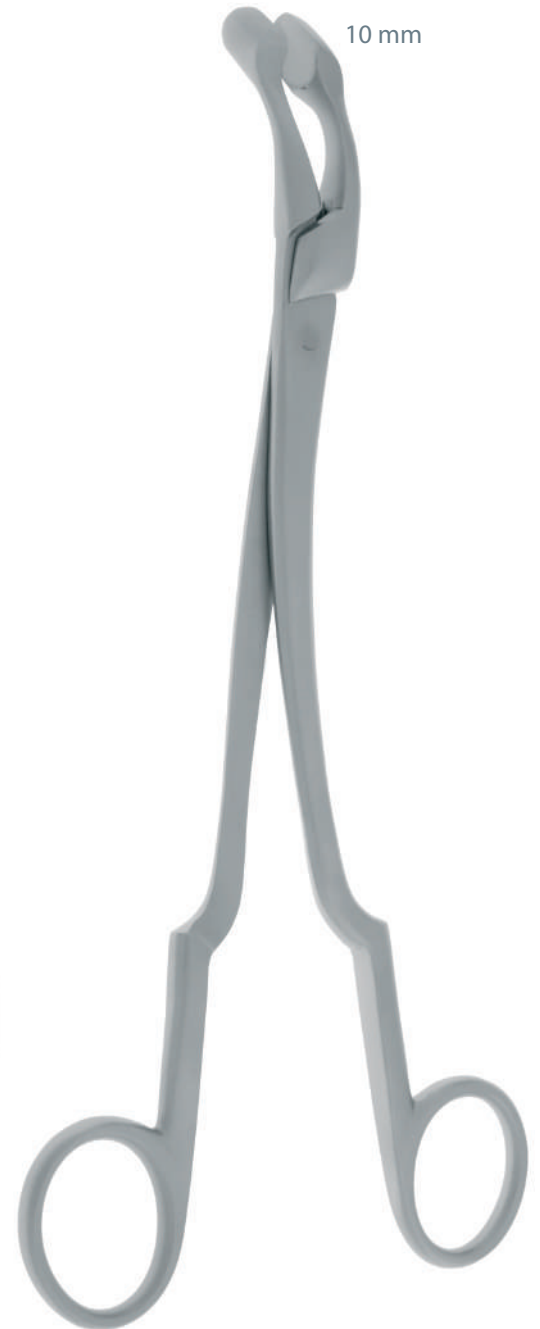

I15010
22 cm - 8 3/4"

10 mm

CRAIG-DOMNICK

17,5 cm - 7" **I150310** 5 mm

17,5 cm - 7" **I150311** 5 mm



Courbe à droite
Curved on right
Curva a la derecha

5 mm

I150310



Courbe à gauche
Curved on left
Curva a la izquierda

5 mm

I150311



I150311
17,5 cm - 7"

LUC

Mors pleins Mors fenêtrés
Full jaws Open work jaws
Bocas llenas Bocas perforadas

20 cm - 8" **I15032** **I15038** 7 mm

20 cm - 8"  **I15034** **I15042** 9 mm

20 cm - 8" **I15036** **I15044** 11 mm

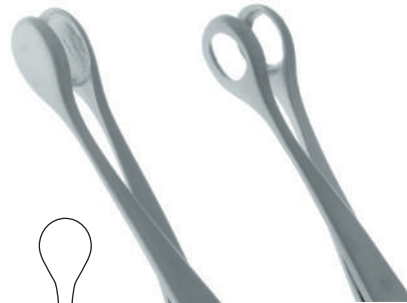

I15042



7 mm
I15032



9 mm
I15034



11 mm
I15036



7 mm
I15038



9 mm
I15042



11 mm
I15044



I15034
20 cm - 8"

LE MEE

Ø 1 mm	I15141-0
Ø 2 mm	I15142-0
Ø 3 mm	I15145-0
Ø 4 mm	I15146-0 
Ø 5 mm	I15147-0
Ø 6 mm	I15148-0



I15146-0

HARTMANN

Ø 2 mm	I151382
Ø 3 mm	I151383
Ø 4 mm	I151384 
Ø 5,5 mm	I151385
Ø 6,5 mm	I151386
Ø 7,5 mm	I151388



I151384

DUPLAY

Adultes	Enfants
Adults	Children
Adultos	Niños
 I15150	I15151



I15150

VACHER

Adultes	Enfants
Adults	Children
Adultos	Niños
 I15160	I15170



I15160

BOWMAN (PALMER)

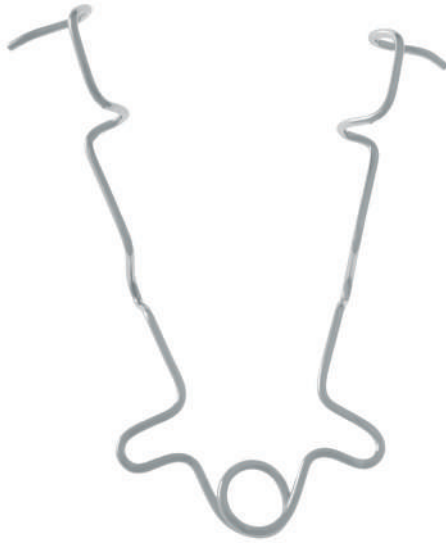

I151305
7 cm - 2 3/4"

BOSE



I151306
7 cm - 2 3/4"

THUDICHUM (GOLDSMITH)



I151311
6,5 cm - 2 1/2"

Petit
Small
Pequeñas

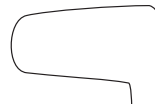

9 mm **I151310**

Moyen
Medium
Medianas

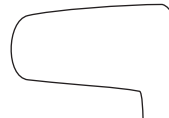

11 mm **I151311** 

Grand
Large
Grandes

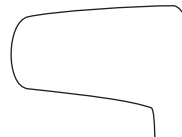



13 mm **I151312**

COTTLE (KILLIAN)

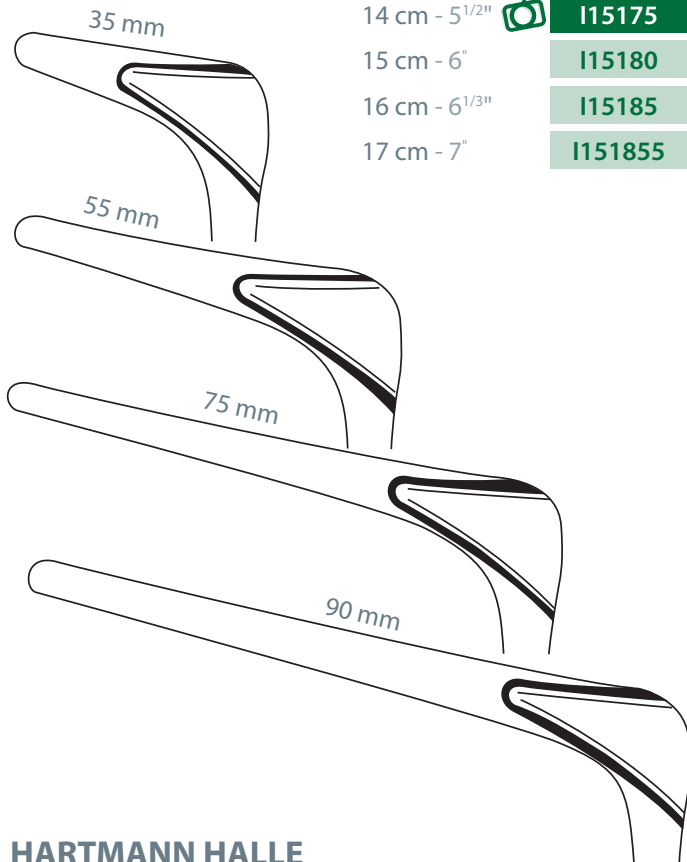

I15175
14 cm - 5 1/2"



14 cm - 5 1/2"	 I15175	35 mm
15 cm - 6"	I15180	55 mm
16 cm - 6 1/3"	I15185	75 mm
17 cm - 7"	I151855	90 mm

HARTMANN HALLE



I151862
15 cm - 6"

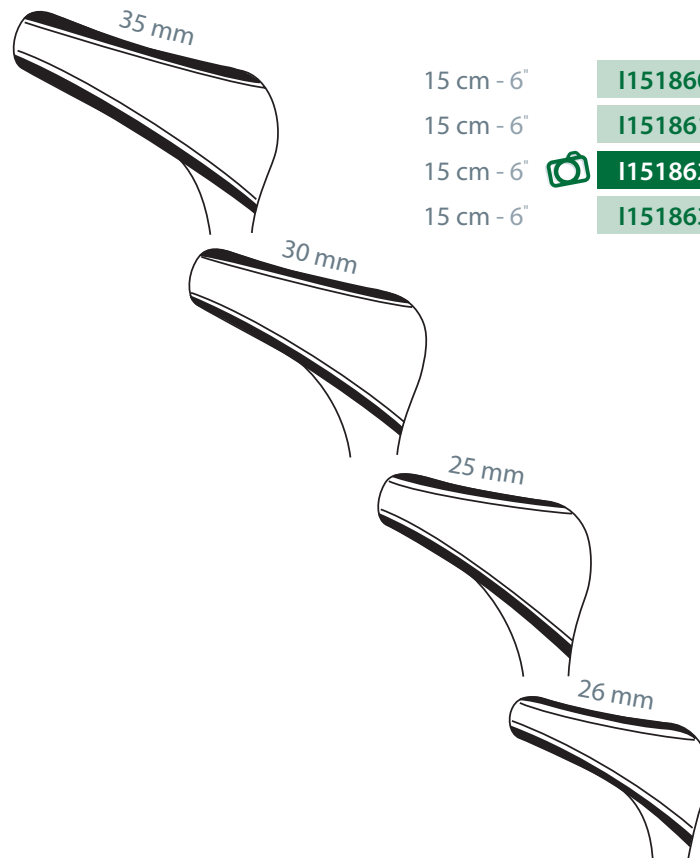

15 cm - 6"	I151860	26 mm
15 cm - 6"	I151861	25 mm
15 cm - 6"	 I151862	30 mm
15 cm - 6"	I151863	35 mm

TIECK



I151872
13 cm - 5"



I151871

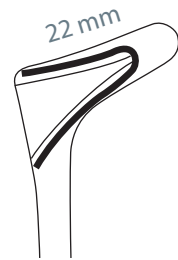

I151872

	Enfants Children Niños	Nourrissons Infants Niños de pecho
13 cm - 5"	I151872 22 mm	I151871 17 mm

WIEN



I151882
14 cm - 5 1/2"

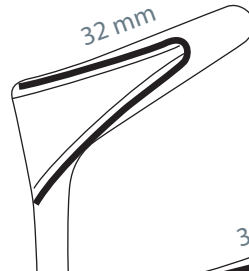

I151883

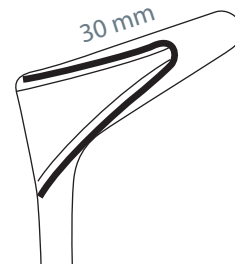

I151882



I151881

14 cm - 5 1/2"	I151881	28 mm
14 cm - 5 1/2"	I151882	30 mm
14 cm - 5 1/2"	I151883	32 mm

VACHER

EVE

BRUENINGS

Canule seule
Cannula only
Canula sóla



I15200
13,5 cm - 5 1/4"

Complet avec canule
Complete with cannula
Completo con canula

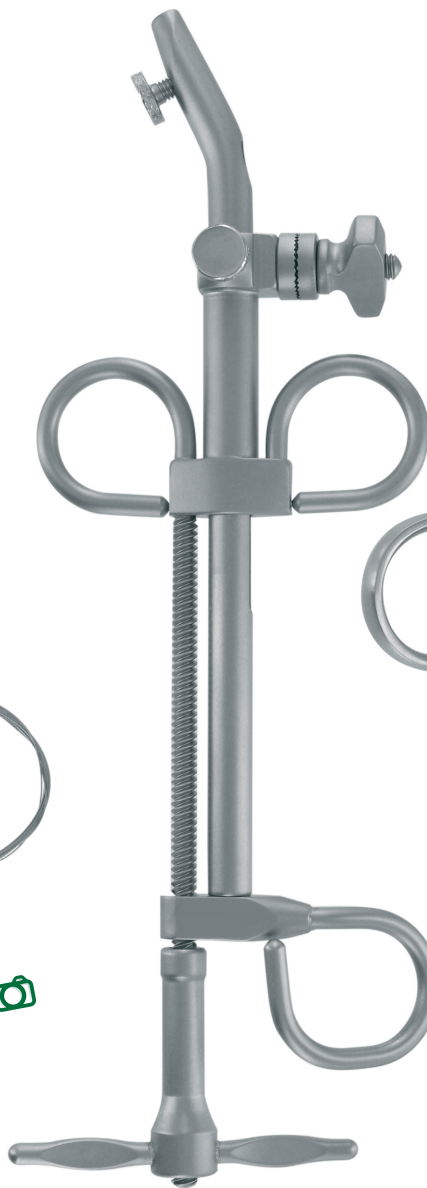

I15190
22,5 cm - 32 cm - 8 4/5" - 12 1/2"

Fil
Wire
Hilo

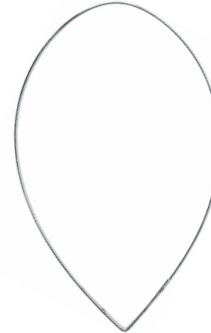

I152091

Ø 0,4 mm



Fil inox
Stainless wire
Hilo inoxidable

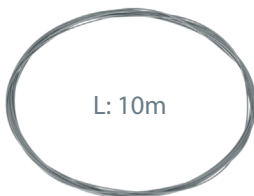

L: 10m

I152003

Ø 0,3 mm

I152004 

Ø 0,4 mm

I152001

Ø 0,5 mm

I152002

Ø 0,6 mm



I152090
28 cm - 11"



I152092
28 cm - 11"

KRAUSE-VOSS

KRAUSE

Complet avec canule - Complete with cannula - Completo con canula

18 cm - 7 1/4"

I152110

26 cm - 10 1/4"

I152100



18 cm - 7 1/4"

I152115

26 cm - 10 1/4"

I152105



Verticale
Vertikal
Vertical

Horizontale
Horizontal
Horizontal

Canule seule
Snare tube only
Canula sóla

Canule seule
Snare tube only
Canula sóla

I152101

I152102

I152106

I152100
26 cm - 10 1/4"

I152105
26 cm - 10 1/4"

O.R.L. aiguilles à paracentèse - E.N.T. paracentesis needles - O.R.L. agujas e para paracentesis



I15240
11 cm - 4^{1/4}"

Adultes
Adults
Adultos



I15230
8 cm - 3^{1/4}"

Enfants
Children
Niños



I15232
8 cm - 3^{1/4}"

Nourrissons
Babies
Niños de pecho



I15234
8 cm - 3^{1/4}"

CORPS ÉTRANGERS
FOREIGN BODIES
CUERPOS EXTRAÑOS

Droite
Straight
Recta



I15250
13 cm - 5"

Coudée
Angled
Angulada



I15220
16,5 cm - 6^{1/2}"

LERMOYER

23 cm - 9"

10 mm	I15340
14 mm	I15342
16 mm	I15344 
20 mm	I15346



I15344
23 cm - 9"

BECKMANN

21 cm - 8 1/4"

12 mm	I15348
14 mm	I15350 
16 mm	I15360
18 mm	I15370



I15350
21 cm - 8 1/4"

BECKMANN (MOORE)

Avec panier
With basket
Con cesto

-	8 mm
I153990	10 mm
I153991	11 mm
I153992	12 mm
I153993	13 mm
I153995	15 mm
I153996	16 mm

Sans panier
Without basket
Sin cesto

I153978	
I153980	
I153981	
I153982	
I153983	
I153985	
I153986	



I153992

21,5 cm - 8 1/4"

I153982

21,5 cm - 8 1/4"

BALLENGER

I154903

3 mm

I154913



I154904

4 mm

I154914



I154905

5 mm

I154915

Droits
Straight
Rectas

Coudés
Angled
Angulada

4



I154904

20 cm - 8"



I154914

20 cm - 8"

KOCHER



I15330
16 cm - 6 1/4"

RUAULT



I15495
22 cm - 8 3/4"



I15500
22 cm - 8 3/4"

Boutonnée
With tip
Abotonado

ABRAHAM



I155010
22 cm - 8 3/4"

Courbe
Curved
Curva

XII - O.R.L.
XII - E.N.T.
XII - O.R.L.

SLUDDER-BALLENGER

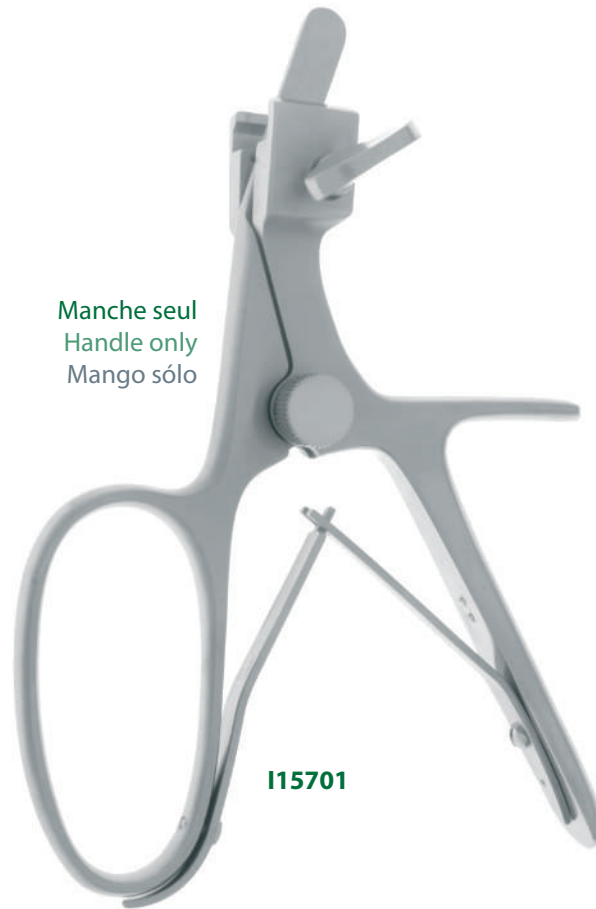

Manche seul
Handle only
Mango sólo

I15701

Lames seules
Blades only
Hojas sólo

N° 1 - 20 mm

I15703

N° 2 - 24 mm

I15704

N° 3 - 27 mm

I15705



I15705
N° 3 - 27 mm

KERRISSON

3,5 mm	I16005
4 mm	I16010 
5 mm	I16015
6 mm	I16020



CITELLI

2 mm **I160439**



XII - O.R.L.
XII - E.N.T.
XII - O.R.L.

TAKAHASHI

Droite
Straight
Recta

Coudée vers le haut
Angled upward
Angulada arriba

12 cm - 4^{3/4}"

I160250

3 x 10 mm

I160260



17 cm - 6^{3/4}"

I160255

3 x 10 mm

12 cm - 4^{3/4}"



I160250

12 cm - 4^{3/4}"

I160260



HARTMANN

12 cm - 4^{3/4}"

I16055

5 mm

12 cm - 4^{3/4}"

I160570

7 mm

12 cm - 4^{3/4}"

I16060

9 mm



ø 5 mm

ø 7 mm

ø 9 mm

STRUYCKEN



12 cm - 4^{3/4}"

I160611

1,0 x 16 mm

1,0 x 16 mm

GRUENWALD

HAJEK



12 cm - 4^{3/4}"

I171103

3,5 x 10,5 mm

12 cm - 4^{3/4}"

I160620

3,5 x 14 mm

3,5 x 10,5 mm

3,5 x 14 mm

JANSEN
(MIDDLETON)

5 mm

4 mm

4 articulations
4 articulations
4 articulaciones



I16035
19 cm - 7 1/2"



I160360
19 cm - 7 1/2"



O.R.L. pinces à polypes - E.N.T. polypus forceps - O.R.L. pinzas para pólipos



O.R.L. pincers pour oreilles - E.N.T. ear forceps - O.R.L. pinzas para orejas

HARTMANN

8,5 cm - 3 1/4"



Sans griffes
Without teeth
Sin dientes

8,5 cm - 3 1/4" **D03170**

14 cm - 5 1/2" **D03190**

D03170

8,5 cm - 3 1/4"

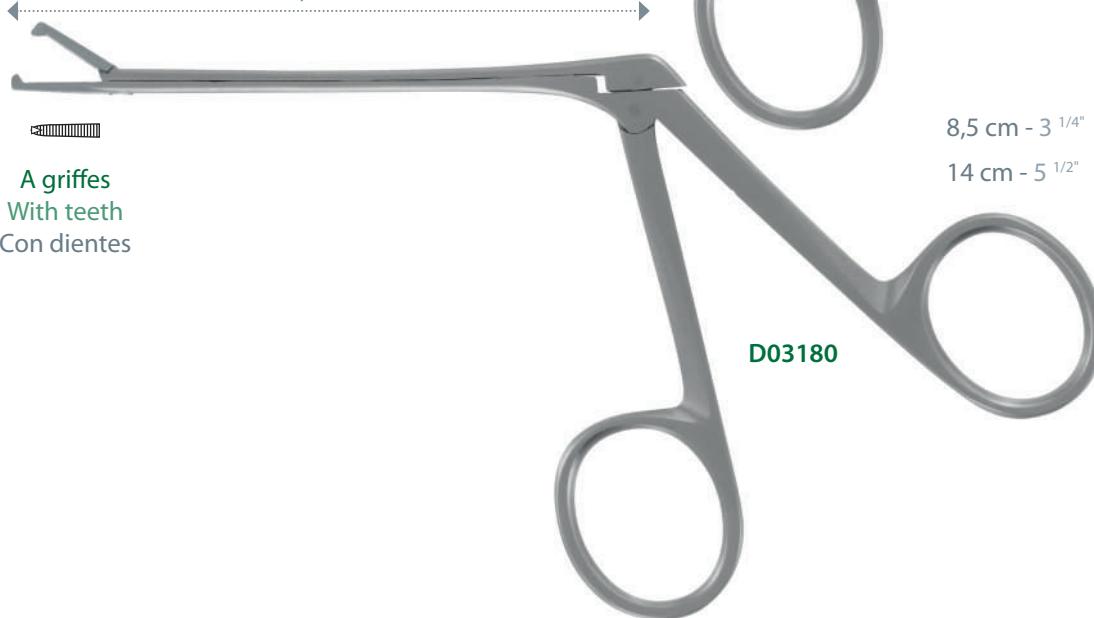

A griffes
With teeth
Con dientes

8,5 cm - 3 1/4" **D03180**

14 cm - 5 1/2" **D03191**

D03180

HARTMANN WEINGARTNER

8,5 cm - 3 1/4"



D031920
8,5 cm - 3 1/4"

BUCK



D034000

1,3 X 9 mm

QUIRE

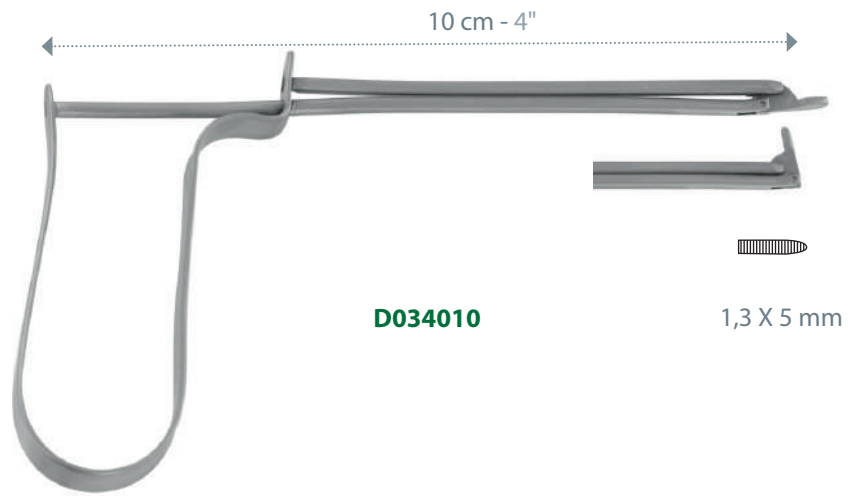

D034010

1,3 X 5 mm

HARTMANN

- 12 cm - 4 ³/₄" **D035000**
- 14 cm - 5 ¹/₂" **D035010**
- 16 cm - 6 ¹/₄" **D035020** 
- 20 cm - 8" **D035030**



D035020
16 cm - 6 ¹/₄"



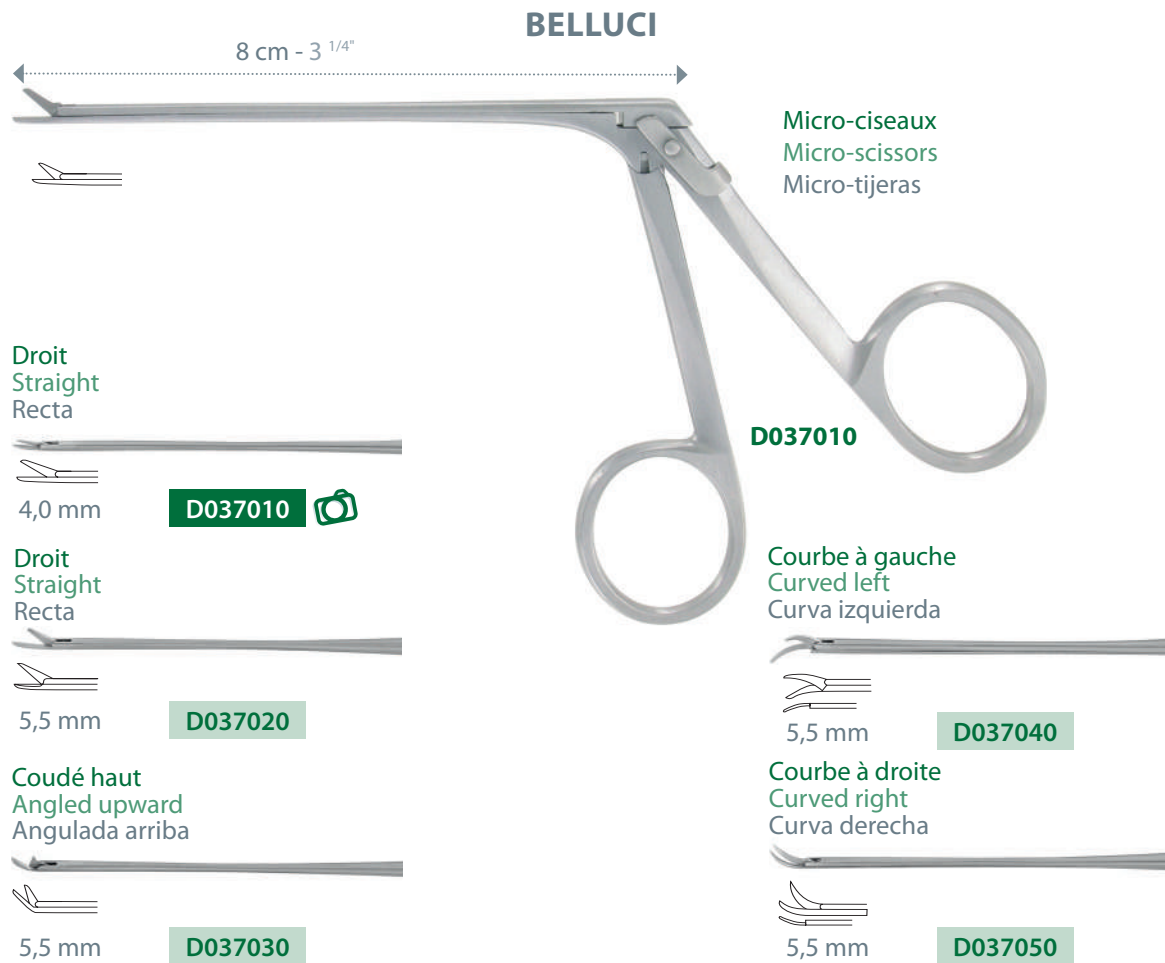
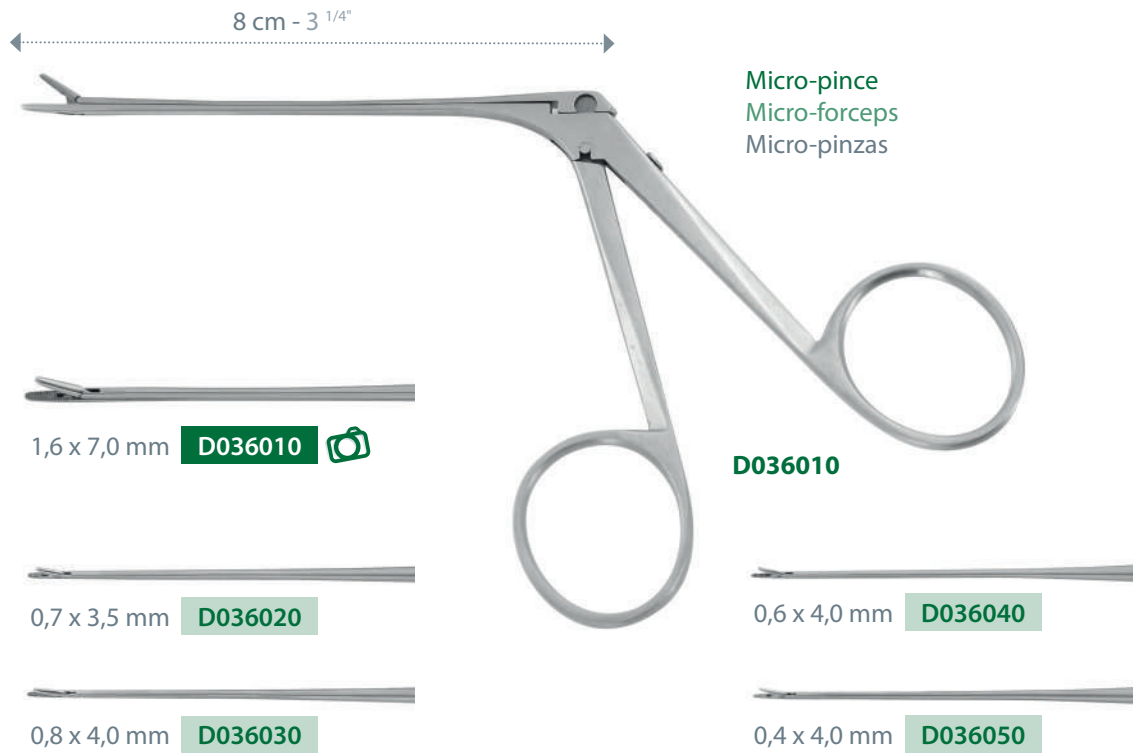

MOORE

Cranté
Serrated
Serrado



I16040
20 cm - 8"

ASCH



I160300
23 cm - 9"

RUBIN



4 articulations
4 articulations
4 articulaciones

5 mm

I160310
20 cm - 8"

LANDANGER

O.R.L. pincés à repositionner - E.N.T. reposition forceps - O.R.L. pinzas para reposicionar

ROWE

Gauche
Left
Izquierda

Droit
Right
Derecha

I162000

22,5 cm - 8 3/4"

I162001

I162010

23,5 cm - 9 1/4"

I162011



I162020

24,0 cm - 9 1/2"

I162021



I162020
24 cm - 9 1/2"

I162021
24 cm - 9 1/2"

WALSHAM

Gauche
Left
Izquierda

Droit
Right
Derecha

23 cm - 9"

I162041

I162040

I162042



I162041

I162042

I162040
23 cm - 9"

Connecteur
Connector
Conector



I162030
5 cm - 2"

CHEVALIER-JACKSON

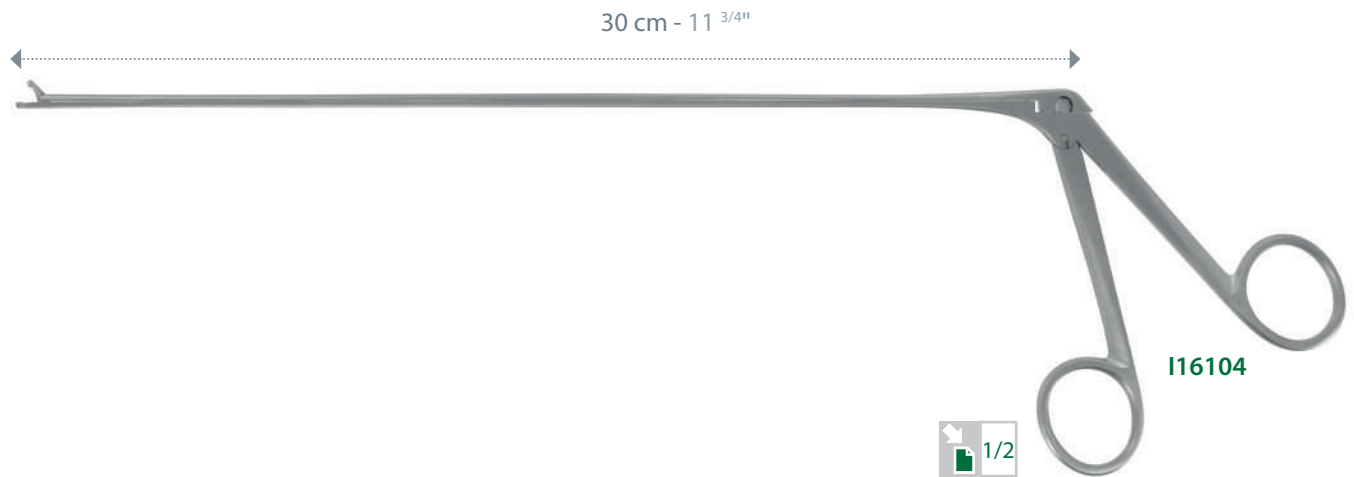

30 cm - 11 ³/₄"

Mors dents de brochet - Pike teeth jaws - Bocas dientes lucio

116100



116102

Mors en curette - Curette jaws - Bocas curetas



116104



Ø 2 mm

116106

Mors emporte pièce - Punch jaws - Bocas cortador

116108



3 x 6 mm

116110

Mors en creux - Hollow jaws - Bocas hueco

116112



4 x 10 mm

116114

ROBIN

8 x 12 mm	I17001	
10 x 14 mm	I170009	
12 x 16 mm	I170008	
14 x 18 mm	I170007	

FREER

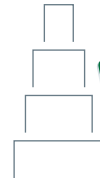

I170020	4 mm	I170010
I170021	7 mm	I170011
I170022	9 mm	I170012
I170023	12 mm	I170013

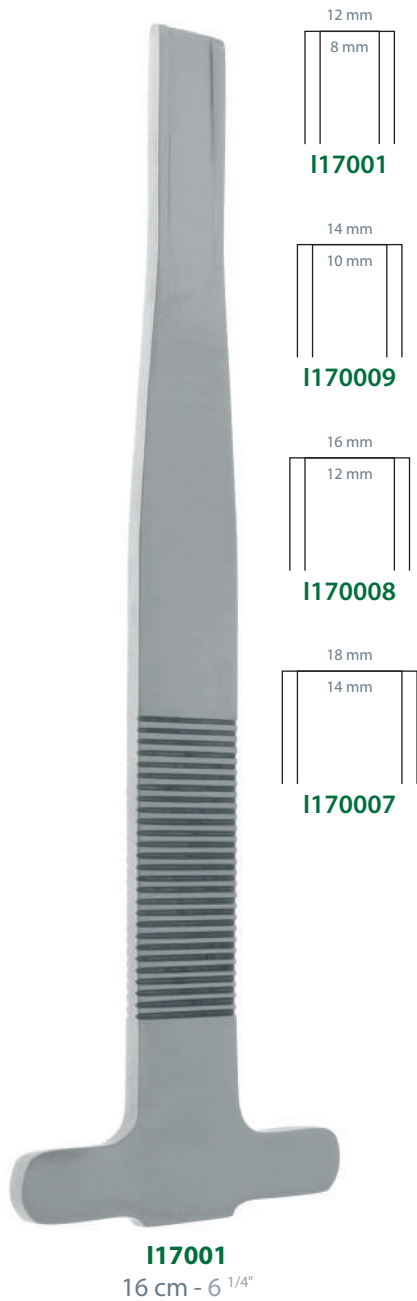

Burin
Chisel
Cinceles

7 mm

Ostéotome
Osteotome
Osteotomo



PARTSCH (HAUTANT)

1 mm	-		I170191
2 mm	J320612		I170192
3 mm	J320613		I170193
4 mm	J320614		I170194
5 mm	J320615		I170195
6 mm	J320616		I170196
7 mm	J320617		I170197
8 mm	J320618		I170198

LELIEVRE

	Burin fin Fine chisel Cinzel fino	6 mm
4 mm	I170460	
6 mm	I170461	

4 mm
Burin
Chisel
Cinceles



J320614
13,5 cm - 5^{1/4}"

3 mm
Gouge
Gouge
Gubias



I170193
13 cm - 5"



I170461
21 cm - 8^{1/4}"

MASING (SILVER)

CINELLI

A gauche
On the left
A la Izquierda



I170031
17,5 cm - 7"

Droit
Straight
Recta



I170030
17,5 cm - 7"

A droite
On the right
A la Derecha



I170032
17,5 cm - 7"

10 mm **I170040**

12 mm **I170042** 

14 mm **I170044**

16 mm **I170046**



I170042
16 cm - 6 1/4"

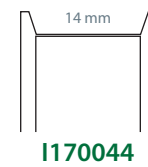

LEBEAU

FREER

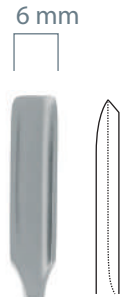

I170920
15 cm - 6"

BALLENGER

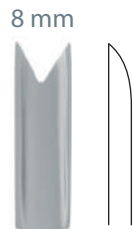
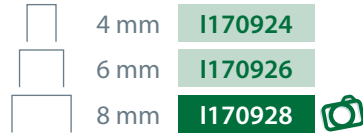

I170928
16 cm - 6 1/4"

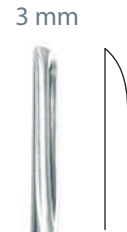
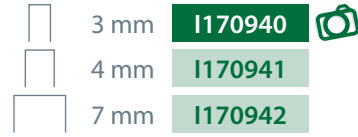

I170940
20 cm - 8"

KILLIAN

Droite
Straight
Recta



Baïonnette
Bayonet
Bayoneta

En V
V form
Forma V



I17108
15 cm - 6"

I17110
15 cm - 6"

SEBILEAU

PENNINGTON

Droite
Straight
Recta

4 mm



I17100
15 cm - 6"

1/2 courbe
1/2 curved
Media curva

4 mm



I17102
15 cm - 6"

Courbe
Curved
Curva

4 mm



I17104
15 cm - 6"



I171060
21 cm - 8 1/4"

TAKAHASHI

Convexe
Convex
Convexo

7 mm

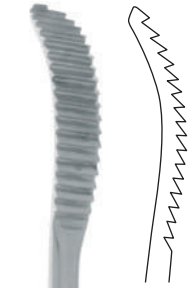

I17112
19 cm - 7¹/₂"

DUFOURMENTEL

Concave
Concave
Concava

7,5 mm

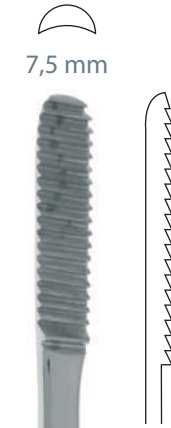

I17116
18 cm - 7"

MALTZ

9 mm

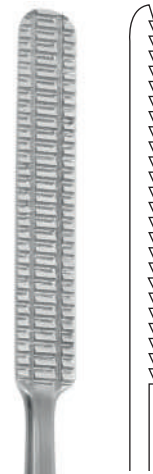

I171170
19 cm - 7¹/₂"

GALLAHER

Droite
Straight
Recta

7 mm



I17118
16 cm - 6¹/₄"

LEWIS

Denture fine
Fine toothing
Dentado fino



I171260
18 cm - 7"

COTTLE

7 mm



I171270
21 cm - 8 1/4"

AUFRICHT

Denture vers l'avant
Toothing forwards
Dentado acia adelante

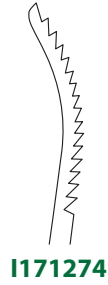

I171274

Denture vers l'arrière
Toothing backwards
Dentado hacia atrás

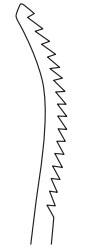

I171275



I171275
21 cm - 8 1/4"



MILLER



I171280
18 cm - 7"

FOMON

Denture fine
Toothing fine
Dentado fino

6.5 mm



I171242
7.5 mm
20.5 cm - 8"

Denture forte
Toothing strong
Dentado fuerte

6.5 mm



I171243
7.5 mm
20.5 cm - 8"

7.5 mm



I171245
7.5 mm
20.5 cm - 8"

12 dents
12 teeth
12 dientes

Denture
Toothing
Dentado

16/20

24/30



I171246
20.5 cm - 8"

I171247
20.5 cm - 8"

36/44

52/62

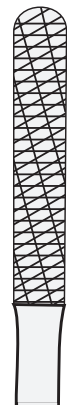

I171248
20.5 cm - 8"

I171249
20.5 cm - 8"

14 dents
14 teeth
14 dientes

FISH

2 mm



J08035

18,5 cm - 7 1/4"

WAGENER

Fin
Fine
Fino

2.5 mm



D04060

14 cm - 5 1/2"

Fort
Strong
Fuerte

3 mm



D04050

14 cm - 5 1/2"

LUCAE

Petit
Small
Pequeñas

2 mm



D040800

14 cm - 5 1/2"

Moyen
Medium
Medianas

2.5 mm



D040801

14 cm - 5 1/2"

Grand
Large
Grandes

3 mm



D040802

14 cm - 5 1/2"

FOMON

Boutonnée
With tip
Abotonado



I171308
17 cm - 6 ³/₄"

FREER

Crochet double
Double hook
Doble gancho

Pointu
Sharp
Aguda



I171305
15 cm - 6 "

KNAPP

Mousse
Blunt
Roma



I171306

ROLLET

Pointu
Sharp
Aguda



I171307
13 cm - 5 "



I171306
13 cm - 5 "

CASTROVIEJO



I171355
8 cm - 3 ¹/₄"

COTTLE NEIVERT

Boutonnée
With tip
Abotonado
5 x 11 mm



I171315
20 cm - 8"

COTTLE

Boutonné - pointu
With tip - sharp
Abotonado - aguda
Pointu - boutonné
Sharp - with tip
Aguda - abotonado



I171311



I171312

4 x 9 mm



I171310
14 cm - 5 1/2"

CONVERSE



I171322
12 cm - 4 3/4"

7 x 12 mm

8 x 12 mm

COTTLE



10 x 12 mm

KILNER

Pointu
Sharp
Aguda
3 x 10 mm



I171318
8 cm - 3 1/4"



I171325
15 cm - 6"

CLAOUE



I17140
9,5 cm - 3 3/4"

I17142
10,5 cm - 4 1/4"

AUBRY (en Z)

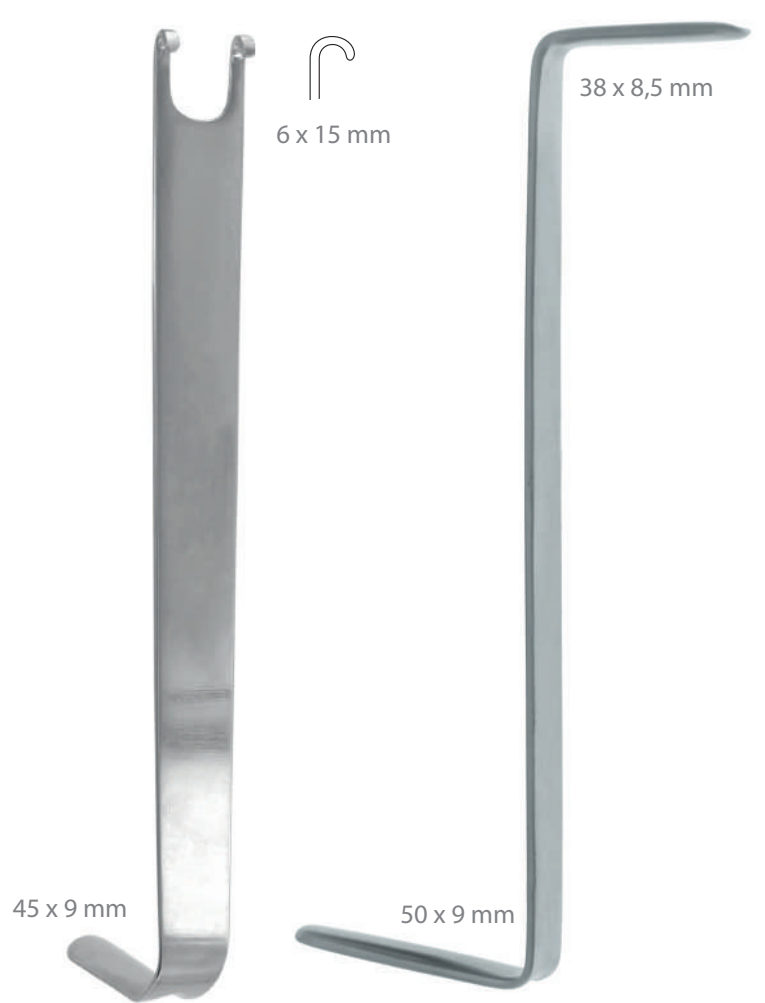

I17144
15 cm - 5 1/4"

I17146
15,5 cm - 5 1/4"

DAUTREY



I171481
13 cm - 5"

I17148
15 cm - 6"

GINESTET

20 mm **I171330**

23 mm **I171331** 

27 mm **I171332**

Petit
Small
Pequeñas



20 mm

I171330

Moyen
Medium
Medianas



23 mm

I171331

Grand
Large
Grandes

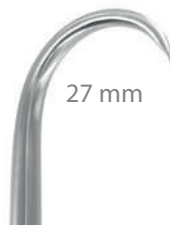

27 mm

I171332



I171331
24,5 cm - 10"

AUFRICHT

45 x 8 mm

Bi-coudé
Bi-angled
Bi-angulada

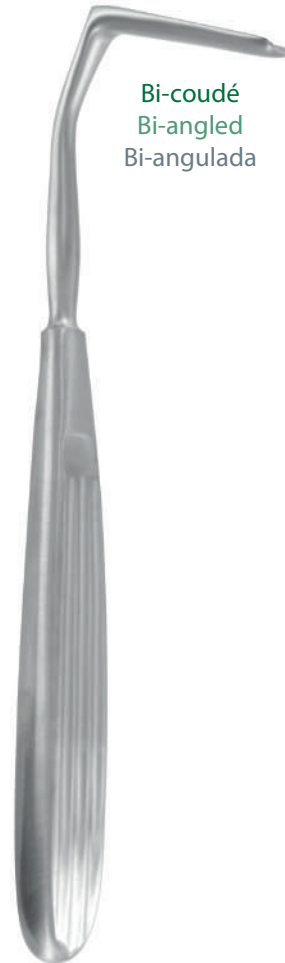

I171340
16 cm - 6 1/4"

GUERRIER

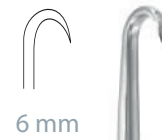

6 mm



I171335
17 cm - 6 3/4"

FREER

Tranchant
Sharp
Cortante

5 mm



I171360



ø 4,5 mm

I171360

18,5 cm - 7 1/4"

Mousse
Blunt
Romo



I171361

KILLIAN

Tranchant
Sharp
Cortante



4,5 mm



Mousse
Blunt
Romo

4,5 mm



I171365

18,5 cm - 7 1/4"

MASING

Mousse
Blunt
Romo



4 mm



Tranchant
Sharp
Cortante

4,5 mm



I171370

20,5 cm - 8"

Mc KENTY

Tranchant
Sharp
Cortante

5 mm



Tranchant
Sharp
Cortante

5 mm

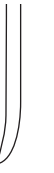

I171375

22cm - 8 3/4"

LEMPERT



I171380
18 cm - 7"

I171381
20,5 cm - 8"

HURD



I171390
22,5 cm - 8 ³/₄"

HENKE

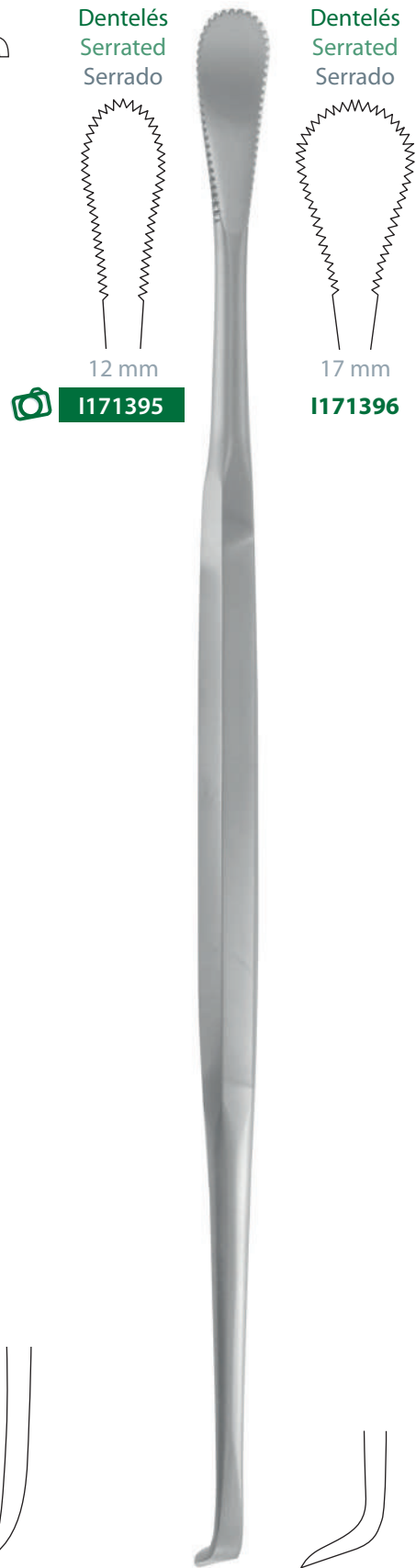

I171395
23 cm - 9"

JOSEPH

3 mm	I171292 
5 mm	I171295
7 mm	I171297
10 mm	I171300

Baïonnette à gauche
Bayonet left
Bayoneta a la izquierda

Baïonnette à droite
Bayonet right
Bayoneta a la derecha

7 mm



I17114
17 cm - 6 ³/₄"



I17155
19,5 cm - 7 ³/₄"



I17150
19,5 cm - 7 ³/₄"

5 mm



I171290
15 cm - 6 "



3 mm
I171292



5 mm
I171295



7 mm
I171297



10 mm
I171300



I171292
16 cm - 6 ¹/₄"



JOSEPH

TRANCHANT - SHARP - CORTANTE

Droit
Straight
Recta

Courbe
Curved
Curva

14 cm - 5 1/2"

I19010

I19020



Élévateur
Elevator
Elevador

Rugine
Raspatory
Raspador

Droite
Straight
Recta
5 mm

Courbe
Curved
Curva
5 mm

3 mm



I19010
14 cm - 5 1/2"



I19030
16,5 cm - 6 1/2"



I19040
17 cm - 6 3/4"



I19050
17 cm - 6 3/4"

SEGURA

95 g **I17160** Ø 18 mm
 115 g **I17162** Ø 20 mm



I17162
20 cm - 8"

BLONDIAU

Mousse
Blunt
Roma
20 mm



I180000
24 cm - 9 1/2"

LIMA

3 mm **I18005** 
 5 mm **I18010**
 7 mm **I18020**



I18005
26 cm - 10 1/4"

SEBILEAU

Pleine
Full
Llena

Ø 4 mm Ø 5 mm

Droite
Straight
Recta

Ø 4 mm **I18021** 
 Ø 5 mm **I18022**

1/2 Courbe
1/2 Curved
1/2 Curva

Ø 4 mm **I18024**
 Ø 5 mm **I18025**

Courbe
Curved
Curva

Ø 4 mm **I18027**
 Ø 5 mm **I18028**

Fenêtrée
Open work
Conventana

Ø 4 mm Ø 5 mm

Droite
Straight
Recta

Ø 4 mm **I18030**
 Ø 5 mm **I18031**

1/2 Courbe
1/2 Curved
1/2 Curva

Ø 4 mm **I18033**
 Ø 5 mm **I18034**

Courbe
Curved
Curva

Ø 4 mm **I18036**
 Ø 5 mm **I18037**



I18021
21 cm - 8"

COAKLEY

BUCK

SNELLEN

	Droite Straight Recta		Courbe Curved Curva	
	I180372	2,8 mm	I180373	
	I180374	3,3 mm	I180375	
	I180376	3,8 mm	I180377	

N° 0	I180382	2,7 mm
N° 1	I180380	3,2 mm
N° 2	I180381	3,7 mm

7 mm



I180002



I180003



I180004

I180002
17 cm - 6 3/4"

Mousse fenêtrée
Blunt fenestrated
Roma fenestrado



N°0
2,8 mm

N°1
3,3 mm

N°2
3,8 mm



I180374
16,5 cm - 6 1/2"



I180375
16,5 cm - 6 1/2"



I180381
16 cm - 6 1/4"



WILLIGER

2,0 x 3,0 mm **I180022** 
 3,0 x 3,5 mm **I180023**

Double ronde
 Double round
 Doble ronda



I180022
 14 cm - 5 1/2"

○ 2,0 mm ○ 3,0 mm
 ○ 3,0 mm ○ 3,5 mm

CLOVIS VINCENT

Malléable Rigide
 Malleable Rigid
 Maleable Rigida

3 x 4 mm **I180030** **I180035** 
 5 x 6 mm **I180031** **I180036**
 7 x 8 mm **I180032** **I180037**
 9 x 10 mm **I180033** **I180038**

Double
 Double
 Doble



I180035
 20 cm - 8"

○ 3 mm ○ 4 mm
 ○ 5 mm ○ 6 mm
 ○ 7 mm ○ 8 mm
 ○ 9 mm ○ 10 mm

BILLEAU

N° 1 **I180385** 
 N° 2 **I180386**
 N° 3 **I180387**

Anses
 Loops
 Bucle



I180385
 16,5 cm - 6 1/2"

○ N° 1
 3,4 mm
 ○ N° 2
 3,9 mm
 ○ N° 3
 4,6 mm

LANDANGER

O.R.L. canules aspiratrices - E.N.T. suction tubes - O.R.L. canulas aspirantes

PLESTER

Ø 1,5 mm	I182015	Ch 5
Ø 2,0 mm	I182020	Ch 6
Ø 2,5 mm	I182025	Ch 8
Ø 3,0 mm	I182030	Ch 9

FRAZIER

Ø 2,0 mm	DC71354-06	Ch 6
Ø 2,5 mm	DC71354-08	Ch 8
Ø 3,3 mm	DC71354-10	Ch 10
Ø 4,0 mm	DC71354-12	Ch 12

WERTHEIMER

Ø 2,0 mm	I180502	Ch 6
Ø 3,0 mm	I180503	Ch 9
Ø 4,0 mm	I180504	Ch 12
Ø 5,0 mm	I180515	Ch 15



FRAZIER

Ø 2,0 mm	I182102	Ch 6
Ø 2,3 mm	I182103	Ch 7
Ø 2,6 mm	I182104	Ch 8
Ø 3,0 mm	I182105	Ch 9 
Ø 3,3 mm	I182106	Ch 10
Ø 4,0 mm	I182108	Ch 12
Ø 5,0 mm	I182109	Ch 15

FERGUSSON

Ø 1,6 mm	I182201	Ch 5
Ø 2,0 mm	I182202	Ch 6
Ø 2,3 mm	I182203	Ch 7
Ø 2,6 mm	I182204	Ch 8
Ø 3,0 mm	I182205	Ch 9 
Ø 3,3 mm	I182206	Ch 10
Ø 4,0 mm	I182208	Ch 12
Ø 5,0 mm	I182209	Ch 15

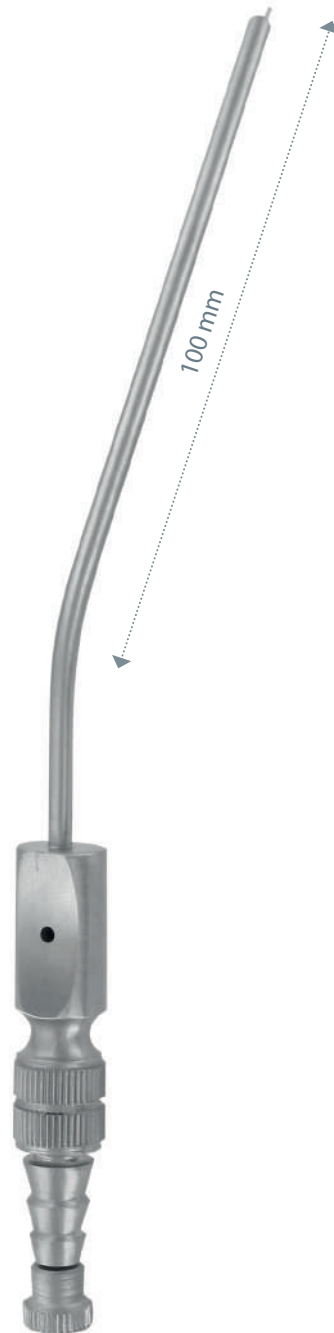

I182105
17 cm - 6^{3/4}"



I182205
17 cm - 6^{3/4}"

HARTMANN

C 128	I180703	250 mm 
C 256	I180704	193 mm
C 512	I180705	152 mm
C 1024	I180706	124 mm
C 2048	I180707	133 mm
C 4096	I180708	131 mm

LUCAE HARTMANN

C 128	I180713	253 mm
C 256	I180714	200 mm 
C 512	I180715	165 mm
C 1024	I180716	138 mm
C 2048	I180717	134 mm
C 4096	I180718	128 mm

FRENCH

C 16	I180720	355 mm
C 32	I180721	293 mm
C 64	I180722	227 mm 
C 128	I180723	170 mm
C 256	I180724	135 mm

Sans curseur
Without cursor
Sin cursor



I180703
25 cm - 10"

Sans curseur avec pied
without cursor with foot
Sin cursor con el pie



I180714
20 cm - 8"

Pied
Foot
Pie

Avec curseur
With cursor
Con cursor



I180722
22,7 cm - 8^{8/9}"

LUCAE

HARTMANN

Avec curseur et pied
With cursor and foot
Con cursor y el pie

C 128



I180733
18 cm - 7"

Pied
Foot
Pie

Avec curseur
With cursor
Con cursor

C 128



I180743
16 cm - 6 1/4"

C 128



I180753
20,6 cm - 8 1/8"

Aluminium
Aluminum
Aluminio

Avec curseur
With cursor
Con cursor

C 256



I180754
17,3 cm - 6 4/5"

Aluminium
Aluminum
Aluminio

Chirurgie des tendons - Surgery for tendons - Cirugía para tendones

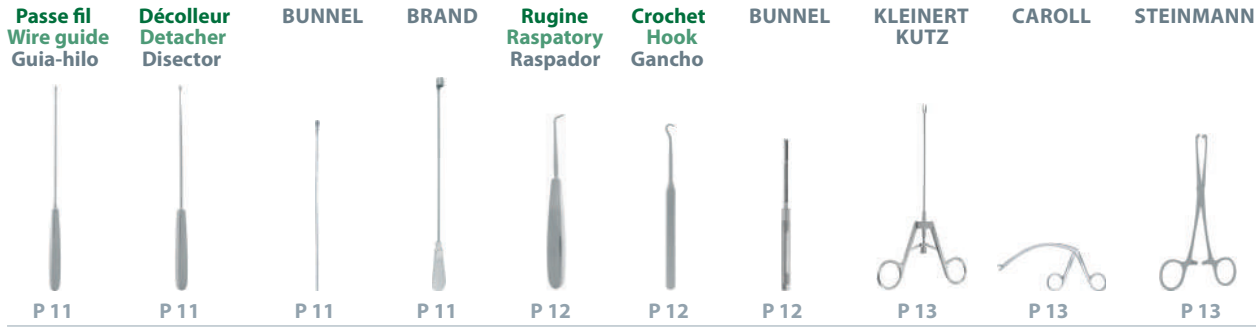

Instrument pour amputation - Instruments for amputation - Instrumentos para amputación

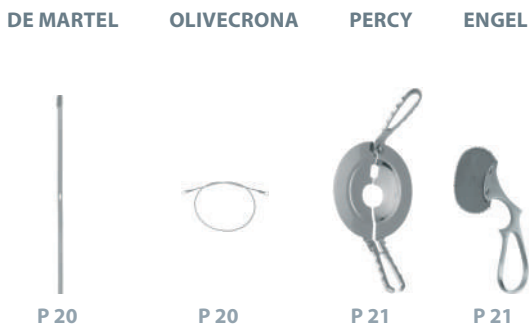
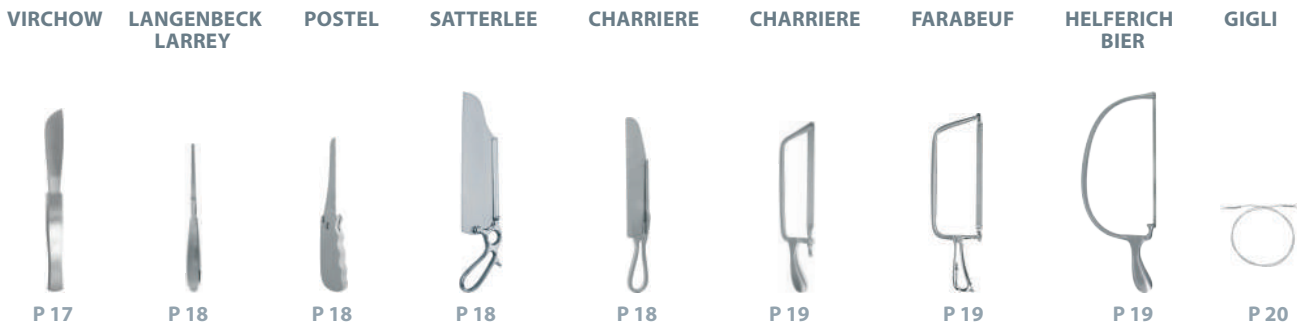
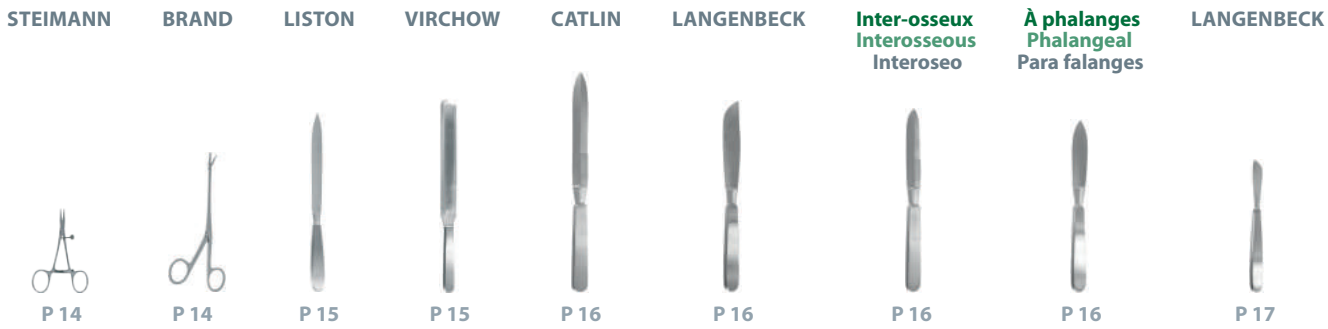

Instruments pour autopsie - Instruments for autopsy - Instrumentos para autopsia

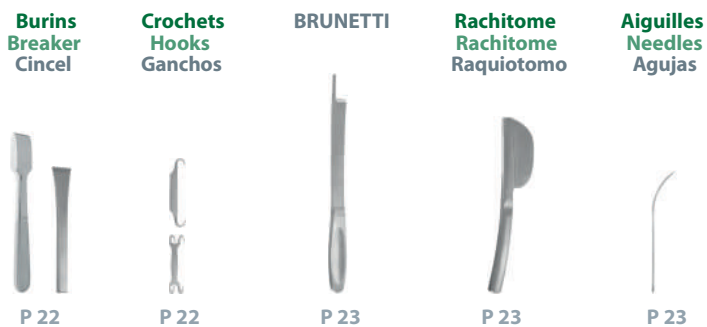

Crochets - Hooks - Ganchos

FISH ADSON CLOWARD CRILE CUSHING CASPAR



Rugines et dissecteurs - Raspatories and elevators - Raspadores y elevadores

OLIVECRONA RIZZUTI FREER FREER YASARGIL MOREL FATIO HOWARTH DAVIS MOLT WOODSON CREED

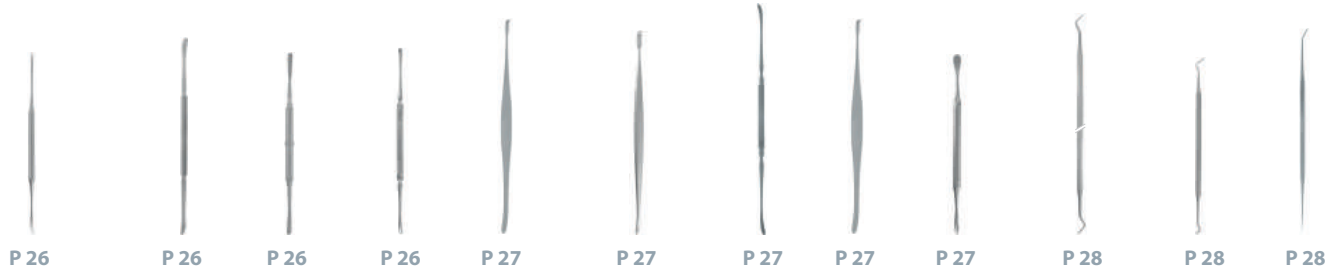

MILLIGAN CARPENTER ROBB SYME JOST ALEXANDER PENFIELD MC DONALD YASARGIL COTTLE WATSON CHEYNE

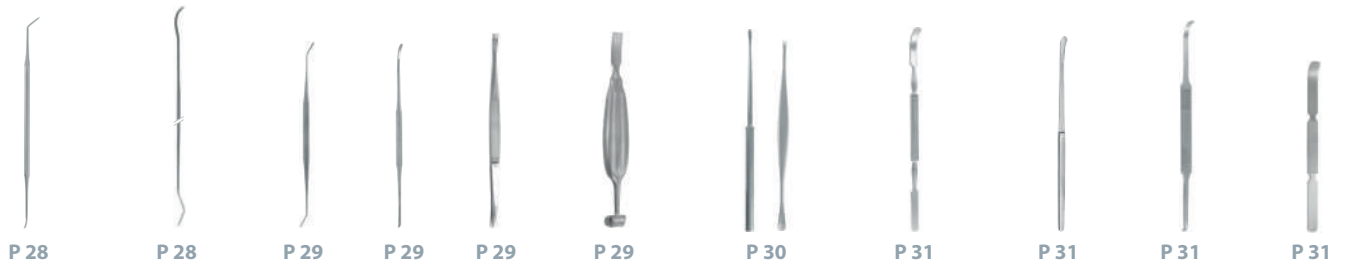



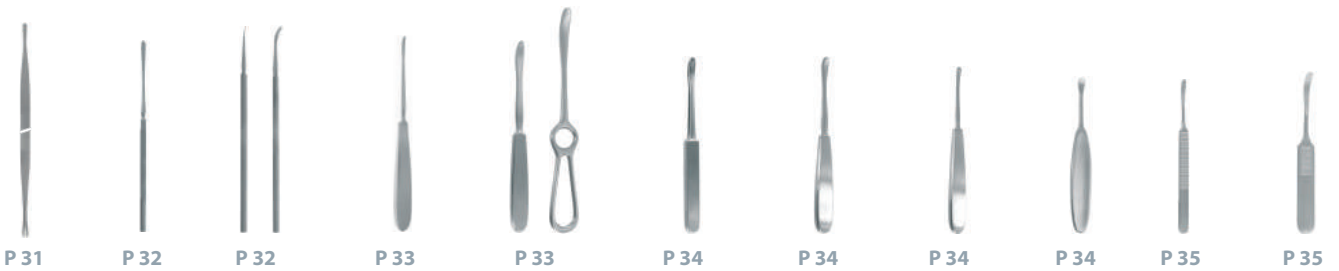



























TOENNIS HALLE ABOULKER LERICHE LANGENBECK LEBEAU YANKAUER SEBILEAU HOEN KÖNIG WILLIGER













SEWALL SACHS HORSLEY FRAZIER SICART CAIRNS CLOVIS VINCENT DE MARTEL PETIT DUTAILLY



Rugines - Raspatories - Raspadores

ADSON	LOVE ADSON	MC KENTY	CASPAR	MUHLING	JANSEN	KRAMER	KEY	CUSHING	PENNYBACKER
									
P 38	P 38	P 39	P 39	P 40	P 40	P 41	P 41	P 41	P 42
LANGENBECK	CUSHING	MITCHELL	KRAEMER	SEDILLOT	COTTLE	FARABEUF	OLLIER	DOYEN	
									
P 42	P 42	P 42	P 43	P 43	P 43	P 44	P 44	P 45	P 46
SEMB	LANGENBECK	ROUX	Pour ligament jaune For yellow ligament Para ligamento amarillo	CLOVIS VINCENT	LELIEVRE	MERLE D'AUBIGNE	LAMBOTTE	MAURER	
									
P 47	P 47	P 47	P 47	P 48	P 48	P 48	P 49	P 49	P 50
COBB	WAGNER								
									
P 51	P 51	P 51							

Curettes - Curettes - Curetás

VIDAL	BROCK	BESNIER	UNNA	MARTINI	WILLIGER	JACOBSON	JANSEN	VOLKMANN	BARTH
									
P 52	P 52	P 52	P 53	P 53	P 53	P 53	P 54	P 54	P 54

Curettes - Curettes - Curetas

VOLKMANN VOLKMANN VOLKMANN SCHEDE BRUNS UFFENORDE CLOWARD HALLE DAUBENSPECK



P 55 P 56 P 57 P 57 P 58 P 58 P 59 P 60 P 60

LEMPERT BRUNS BUSCHE SCOVILLE CASPAR CHARNLEY LETOURNEL



P 61 P 62 P 63 P 63 P 64 P 65 P 65

Ciseaux ostéotomes - Osteotomes - Osteotomos

LAMBOTTE LAMBOTTE DUPONT OBWEGESER
PAUWELLS



P 66 P 67 P 67 P 67

Ciseaux burins, gouges - Bone chisels, gouges - Osea cincelas, gubias

PARTSCH LUCAS **Ciseaux burins** POIRIER OMBREDANNE ALEXANDER SMITH PETERSEN STILLE LUCAS
Bone chisels
Osea cincelas



P 68 P 68 P 69 P 70 P 70 P 71 P 71 P 72 P 73 P 74

HIBBS MAC EVEN JUDET FARABEUFF CAUCHOIX GUILLAUME NANCY SMITH PETERSEN HONTON STAGNARA



P 74 P 75 P 75 P 76 P 77 P 78 P 78 P 78 P 79 P 80

Râpes - Rasps - Raspas



Maillets - Mallets - Martillos



Poinçons - Punches - Punzones



Crochets - Hooks - Ganchos



Mesureurs - Measures - Medidores

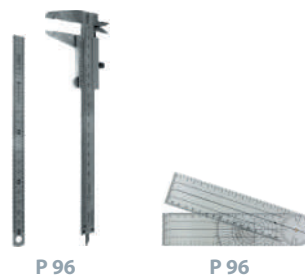

Pinces gougues - Bone rongeur forceps - Pinzas gubias

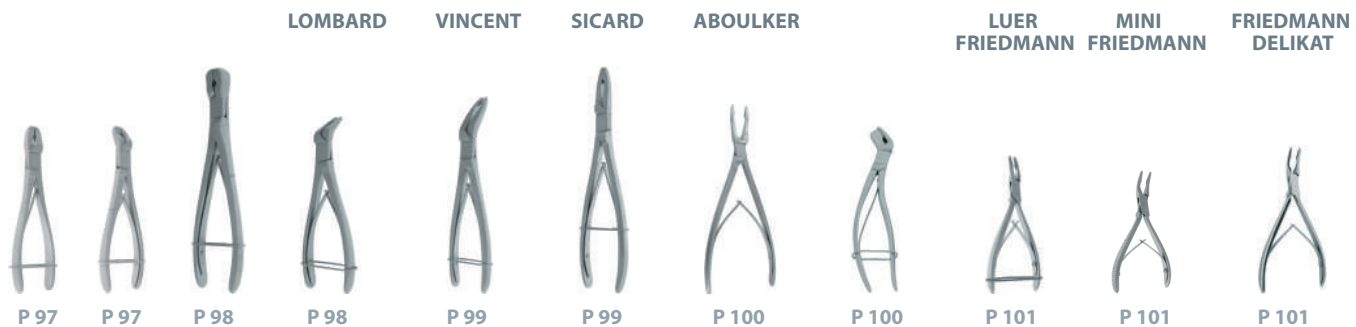

BLUMENTHAL MEAD LUER CLEVELAND HAKANSSON LUER ADSON STELLBRINK BANE HARTMANN JANSEN



OLIVECRONA BEYER LEMPERT NORTHFIELD PENNYBACKER JANSEN STOOKEY BACON BOEHLER

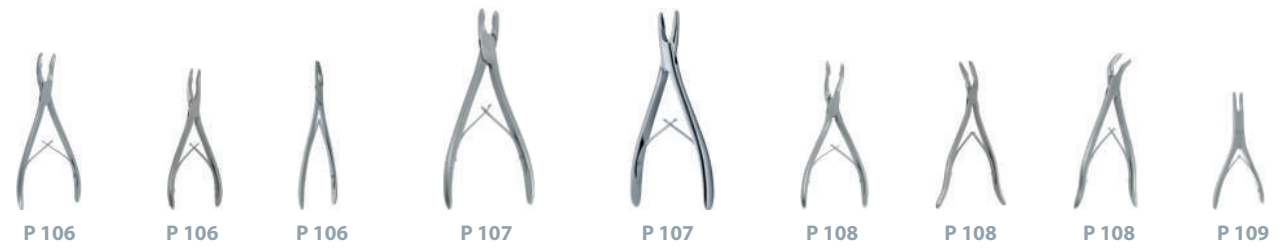

BEYER ZAUFAL BEYER MARQUARDT MAYFIELD RUSKIN STILLE RÖTTGEN RUSKIN SMITH PETERSEN LEKSELL STILLE ECHLIN FRYKHOLM

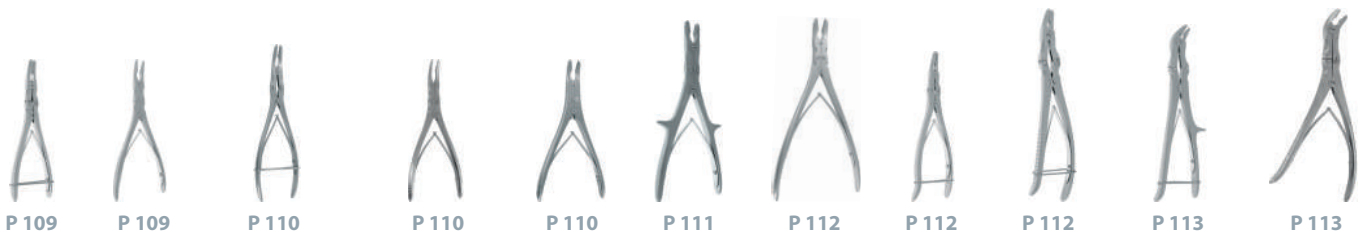

SAUERBRUCH DAVID SEMB STILLE LUER



Pinces coupantes - Bone cutting forceps - Pinzas cortantes

LISTON LITTAUER LISTON CLEVELAND KAZANJIAN RUSKIN LISTON BOEHLER MACINDOE LISTON LISTON-KEY HORSLEY SEMB



Costotomes - Costotomes - Costotomos

COLLIN BETHUNE MAURER BRUNNER GLUCK GIERTZ STILLE SAUERBRUCH FREY SAUERBRUCH VELPEAU TRICOISE DOYEN LEBSCHÉ



P 121 P 122 P 122 P 123 P 123 P 123 P 124 P 124 P 125 P 125 P 125

Daviers - Bone holding forceps - Pinzas para huesos

REILL DINGMANN VERBRUGGE LANDANGER VERBRUGGE VERBRUGGE ULRICH FARABEUF LAMBOTTE



P 126 P 127 P 127 P 128 P 129 P 130 P 131 P 133 P 134

LANE KERN OLLIER SETTER HEY GROVES SEMB LANGENBECK FERGUSSON OLLIER Résection Resection Resección



P 135 P 135 P 136 P 137 P 137 P 138 P 139 P 139 P 140 P 140

Écarteur - Retractor - Separador

À sequestre Sequester Secuestro Distraction Distractor Distracción LOWMAN HUGLUND LOWMAN MUSEUX LERAT LEWIN CHARNLEY



P 140 P 141 P 141 P 141 P 142 P 142 P 142 P 143

Mains de plomb - Lead hands - Manos de plomo



P 143

Chasse-greffons - Grafts pusher - Empujador de injertos

TRILLAT DEMOISELLE PASSOW



P 144 P 144 P 144 P 144 P 145

Instrumentation pour épaule - Shoulder instrumentation - Instrumentación para hombro

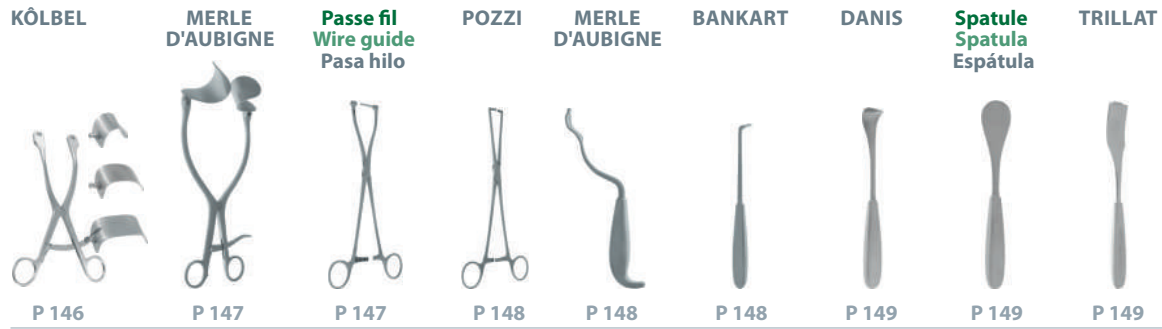

Pour ligatures - For ligatures - Para ligaduras



Pour ménisque - For meniscus - Para menisco

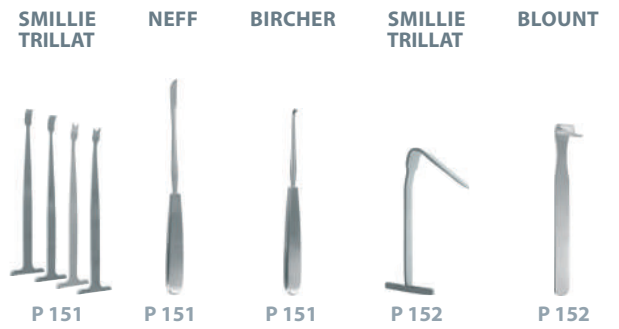

Pour genou - For knee - Para rodilla



Étriers de traction - Traction bows - Estribos de tracción

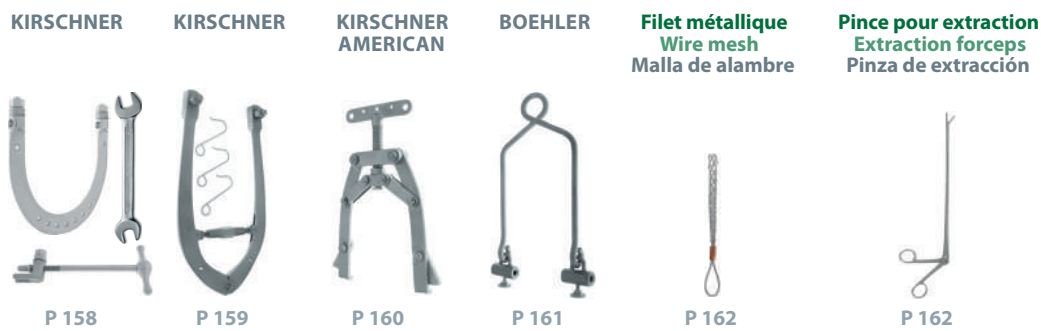

III - Ciseaux
III - Scissors
III - Tijeras

Ciseaux pour chirurgie osseuse - Bone surgery scissors - Tijeras para cirugía ósea

Ciseaux à ménisque
Meniscus scissors
Tijeras para menisco

SMITH



P 86



P 87

VII - Ecarteurs
VII - Retractors
VII - Separadores

BUCK GRAMCKO LANGE HOHMANN WAGNER LANGE HOHMANN LANGE HOHMANN VERBRUGGE MULLER



P 132



P 133



P 133



P 134



P 135



P 136

LANGE HOHMANN



P 137

HOHMANN ALDINGER



P 137

SCHUMACHER WAGNER



P 138

SCHUMACHER



P 138

MERLE D'AUBIGNE



P 139

MERLE D'AUBIGNE



P 140

JUDET



P 140

CHANDLER



P 141

LANE TRETOWAN



P 141

LANE



P 141

BRISTOW



P 141

BLOUNT



P 142

FUKUDA



P 142

BENNET



P 143

TRILLAT



P 143

CAUCHOIX



P 144

SKID MURPHY



P 145

LAMBOTTE



P 145

MOORE LAMBOTTE



P 145

POSTEL



P 146

MAURER



P 146

XII - O.R.L.
XII - E.N.T.
XII - O.R.L.

O.R.L. burins et gouges - E.N.T. chisels and gouges - O.R.L. cinceles y gubias

ROBIN FREER COTTLE HAUTANT LELIEVRE



P 37



P 37



P 37



P 38



P 38



P 38

O.R.L. râpes - E.N.T. rasps - O.R.L. raspas

XII - O.R.L.
XII - E.N.T.
XII - O.R.L.

TAKAHASHI DUFORMENTEL MALTZ GALLAHER LEWIS COTTLE AUFRICHT MILLER FOMON

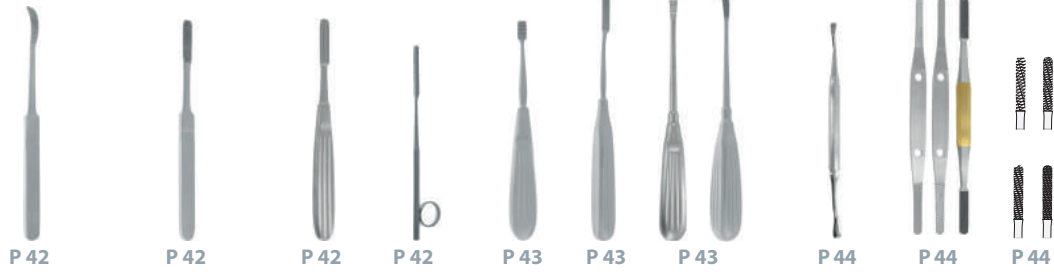

Passe fil
Wire guide
Guia - hilo



J04010
28 cm - 11"

Décolleur
Detach
Disector



J04040
28 cm - 11"

BUNNEL

Guide
Guide
Guia

Malléable
Malleable
Maleable



J040410
23 cm - 9"

BRAND

Guide
Guide
Guia



3 mm

J040420

30 cm - 11^{3/4}"



6 mm

J040430

50 cm - 19^{3/4}"



J040430
50 cm - 19^{3/4}"

BUNNEL

Rugine
Raspatory
Raspador



J04050
18 cm - 7"

Crochet
Hook
Gancho



J04070
17 cm - 6 ³/₄"

J04060

Stripper à tendons
Tendon stripper
Enucleator de tendones

- Ø 2 mm **J040802**
- Ø 3 mm **J040803** 
- Ø 4 mm **J040804**
- Ø 6 mm **J040806**



J040803
15 cm - 6"

KLEINERT-KUTZ

Pour saisir les tendons - To grasp Tendons - Para coger tendones



J041095
20 cm - 8"

CAROLL



J041090
11 cm - 4 1/2"

STEINMANN



J04090
16 cm - 6 1/4"

STEINMANN

BRAND

Pour saisir les tendons - To grasp Tendons - Para coger tendones



J041060
13 cm - 5"



J041070

J041080

J041070
15 cm - 6"

	Courbe Curved Curva	Droite Straight Recta
	J041030 15 cm - 5 3/4"	J041000
	J041040 19 cm - 7 1/2"	J041010
	J041050 24 cm - 9 1/2"	J041020

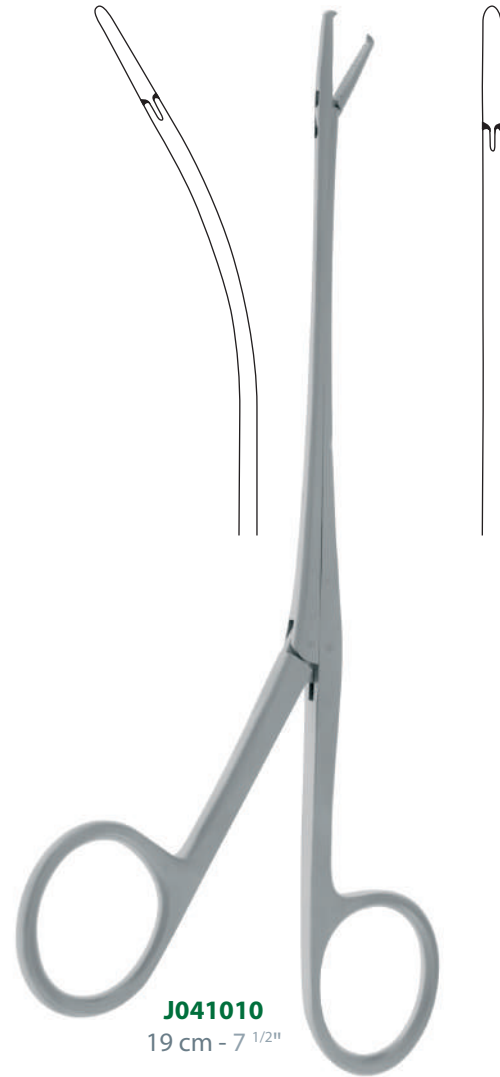

J041010
19 cm - 7 1/2"

LISTON

VIRCHOW

160 mm

Lame
Blade
Hoja

130 mm

J120649

26,5 cm - 10 1/2"

160 mm

J120650 

29,5 cm - 11 1/2"

190 mm

J120651

32,5 cm - 12 3/4"

220 mm

J120652

35,5 cm - 14"

J120650

29,5 cm - 11 1/2"

Lame
Blade
Hoja

150 mm

J12030 

26 cm - 10 1/4"

200 mm

J12060

31 cm - 12 1/4"

J12030

26 cm - 10 1/4"



Lame
Blade
Hoja

160 mm

J141290

30 cm - 11 3/4"

200 mm

J141300 

33 cm - 13"

240 mm

J141310

37,5 cm - 14 3/4"

J141300

33 cm - 13"

175 mm



J14140

28,5 cm - 11 1/4"

CATLIN

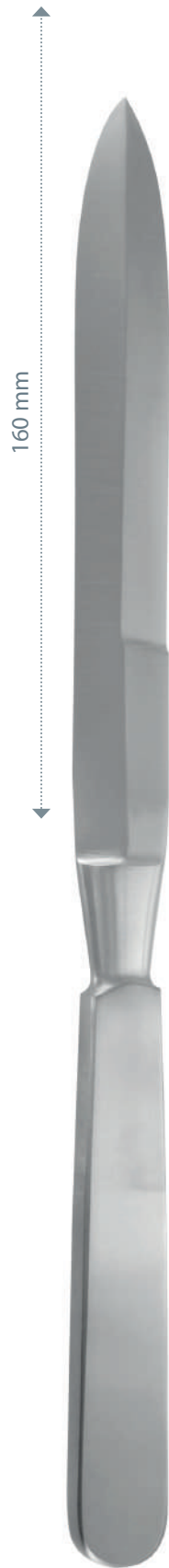

160 mm

J141100
28 cm - 11"

LANGENBECK

Couteaux pour lobes
Flap knives
Cuchillos para lóbulos



120 mm

J141110
26 cm - 10 1/4"

Couteau inter-osseux
Interosseous knife
Cuchillo interóseo



110 mm

J141120
25 cm - 10"

Couteau à phalanges
Phalangeal knife
Cuchillo para falanges



95 mm

J141130
23 cm - 9"

LANGENBECK

VIRCHOW



J141140
18 cm - 7"



J141150
18 cm - 7"



J141160
25 cm - 10"



J141200
17,5 cm - 7"

LANGENBECK (LARREY)



J12230
23 cm - 9"

POSTEL

Lame seule
Blade only
Hoja sólo

J120932
23 cm - 9"

Lame seule
Blade only
Hoja sólo

J120710
14,5 cm - 5 3/4"



J120700
23,5 cm - 9 1/4"

SATTERLEE



J120931
31 cm - 12 1/4"

CHARRIERE

27 cm - 10 3/4"

J120827



30 cm - 11 3/4"

J120830

Lame seule
Blade only
Hoja sólo

18,3 cm - 7 1/4"

J120828

21,3 cm - 8 1/2"

J120831



J120827
27 cm - 10 3/4"

CHARRIERE

Complète avec 2 lames
Complete with 2 blades
Completa con 2 hojas

Lame seule - Blade only - Hoja sólo

12 mm **J121612**

15 mm **J121615**



J121610

35 cm - 13 ³/₄"

FARABEUF

Complète avec 3 lames
Complete with 3 blades
Completa con 3 hojas

Lame seule - Blade only - Hoja sólo

8 mm **J12190**

16 mm **J12220**

20 mm **J12225**



J12180

37 cm - 14 ¹/₂"

HELFERICH-BIER

Complète avec 3 lames
Complete with 3 blades
Completa con 3 hojas

Lame seule
Blade only
Hoja sólo

4 mm **J121623**

6 mm **J121625**

8 mm **J121627**



J121620

42 cm - 16 ¹/₄"



GIGLI

DE MARTEL

Conducteur à crochet simple
 Conductor with simple hook
 Conductor con ganchura simple

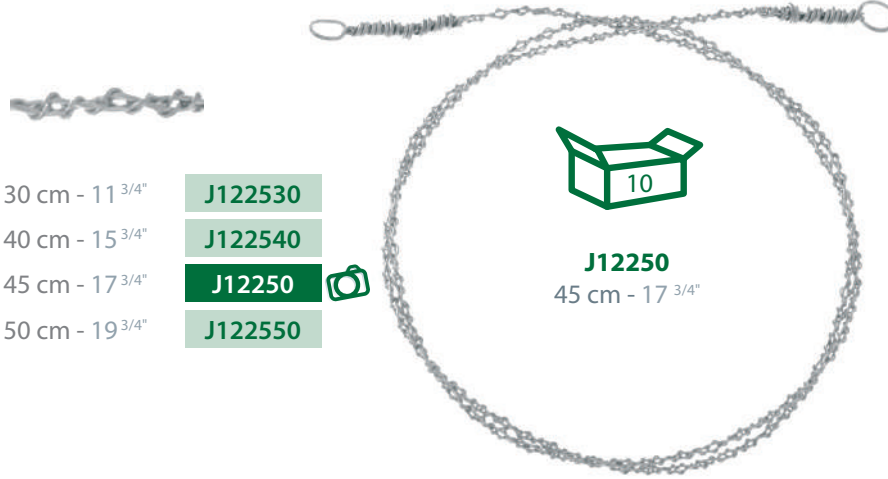

- 30 cm - 11 3/4" **J122530**
- 40 cm - 15 3/4" **J122540**
- 45 cm - 17 3/4" **J12250** 
- 50 cm - 19 3/4" **J122550**

OLIVECRONA

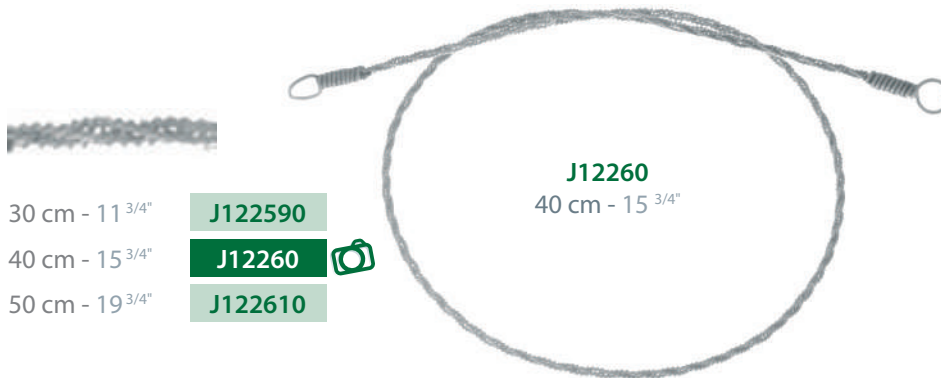

- 30 cm - 11 3/4" **J122590**
- 40 cm - 15 3/4" **J12260** 
- 50 cm - 19 3/4" **J122610**

Poignée pour scie
 Handle for saw
 Puñado para sierra



J12240



J12285
 35 cm - 13 3/4"

PERCY



J12270

ENGEL

Pour os et plâtre
For bone and plaster
Para hueso y yeso



J14090
15 cm - 6"



BURIN POUR LE CRÂNE
SKULL BREAKER
CINCEL ROMPE-CRÂNEO



J140310
14 cm - 5 1/2"

CROCHETS POUR MUSCLES
MUSCLE HOOKS
GANCHOS MUSCULARES



J140400
7 cm - 2 3/4"

22 mm



J14020
16,5 cm - 6 1/2"

22 mm



J140210
13 cm - 5"



J140410
6,5 cm - 2 1/2"

BRUNETTI



15 mm

J140620

J140610
28 cm - 11"

RACHITOME
RACHITOME
RAQUIOTOMO



J140710
22 cm - 8 3/4"

AIGUILLES
NEEDLES
AGUJAS

N° 1 - 135 mm **J140801**

N° 2 - 125 mm **J140802** 

N° 3 - 110 mm **J140803**

N° 4 - 100 mm **J140804**

N° 5 - 85 mm **J140805**

N° 6 - 75 mm **J140806**



J140802
12,5 cm - 5"

FISH

2 mm
Pointu
Sharp
Agudo



J08035
18,5 cm - 7¹/₄"

ADSON

5.5 mm
Mousse
Blunt
Roma



J162320
20 cm - 8"

7 mm
Pointu
Sharp
Agudo



J162330
20 cm - 8"

CLOWARD

2.5 mm
Pointu
Sharp
Agudo



J162310
17,5 cm - 7"

CRILE

7 mm



J162350
20 cm - 8"

CUSHING



J16240

19 cm - 7 1/2"

J162410

28 cm - 11"

4 mm



J16240
19 cm - 7 1/2"

J16245



J162460

6 mm



J16245
19 cm - 7 1/2"

CASPAR

4 mm



J162801

5,5 mm



J162802



7 mm



J162803



4/5



J162802
24,5 cm - 9 5/8"



1/1

OLIVECRONA

Mousse
Blunt
Romo

2,5 mm



Mousse
Blunt
Romo

J162230

18 cm - 7"

J162240
24 cm - 9 1/2"

J162230
18 cm - 7"

3 mm

RIZZUTI

Mousse
Blunt
Romo

4,7 mm



Mousse
Blunt
Romo

J16260

20 cm - 8"

J16265
25 cm - 10"

J16260
20 cm - 8"

4,7 mm

FREER

Tranchant
Sharp
Cortante

4,5 mm



Mousse
Blunt
Romo

J243720

18,5 cm - 7 1/4"

4,5 mm

FREER-YASARGIL

Tranchant
Sharp
Cortante

3 mm



Tranchant
Sharp
Cortante

J243721
18,5 cm - 7 1/4"

3 mm

Rugines et dissecteurs - Raspatories and elevators - Raspadores y elevadores



Rugines et dissecteurs - Raspatories and elevators - Raspadores y elevadores

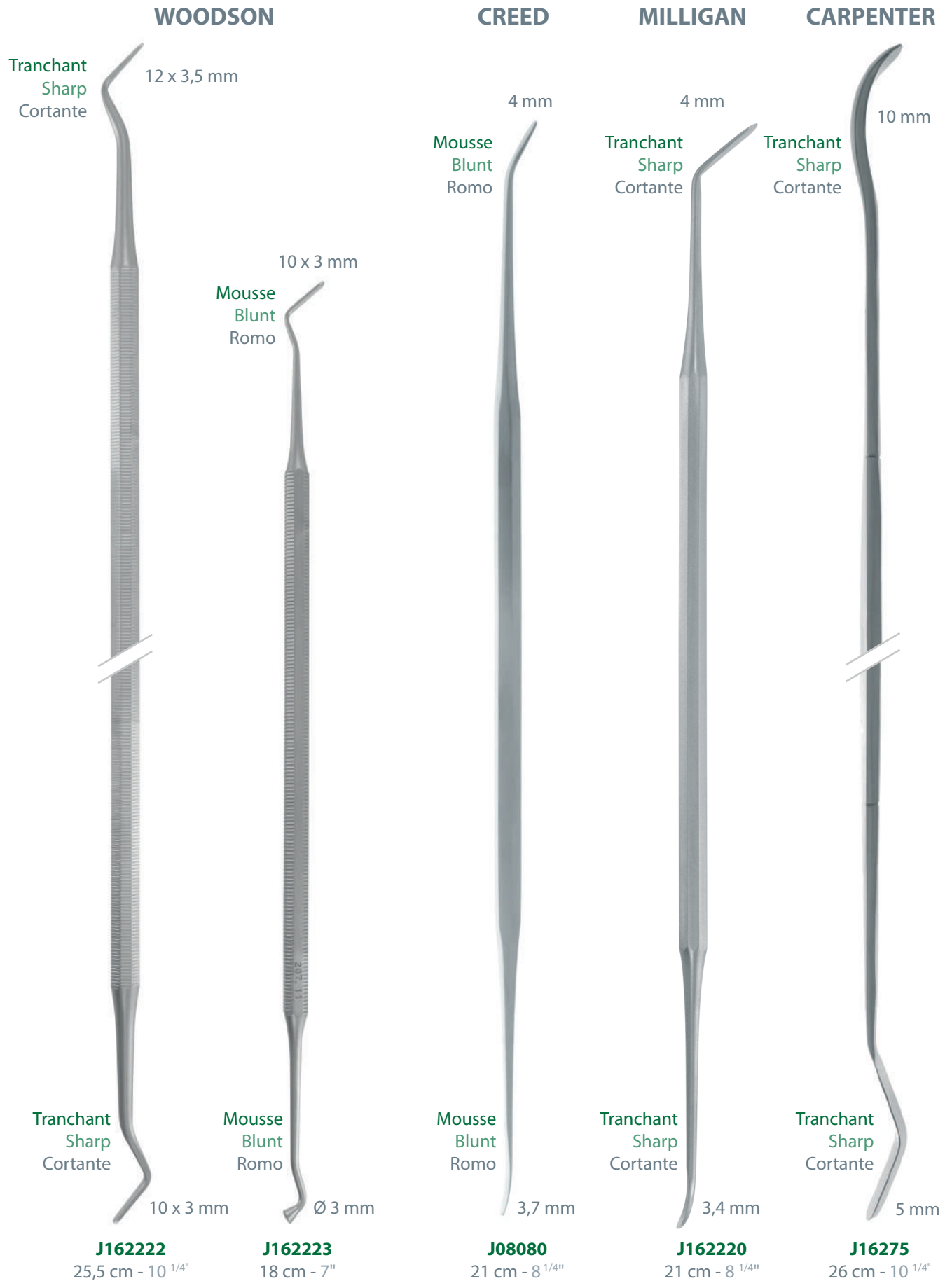

ROBB



J16270
22 cm - 8 3/4"



J162702
19 cm - 7 1/2"

SYME

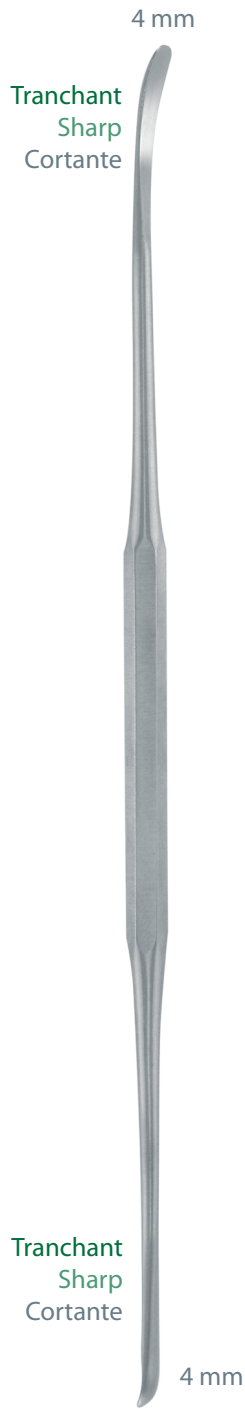

J235505
18,5 cm - 7 1/4"

JOST



J162710
20 cm - 8"

ALEXANDER



J162720
21 cm - 8 1/4"



PENFIELD

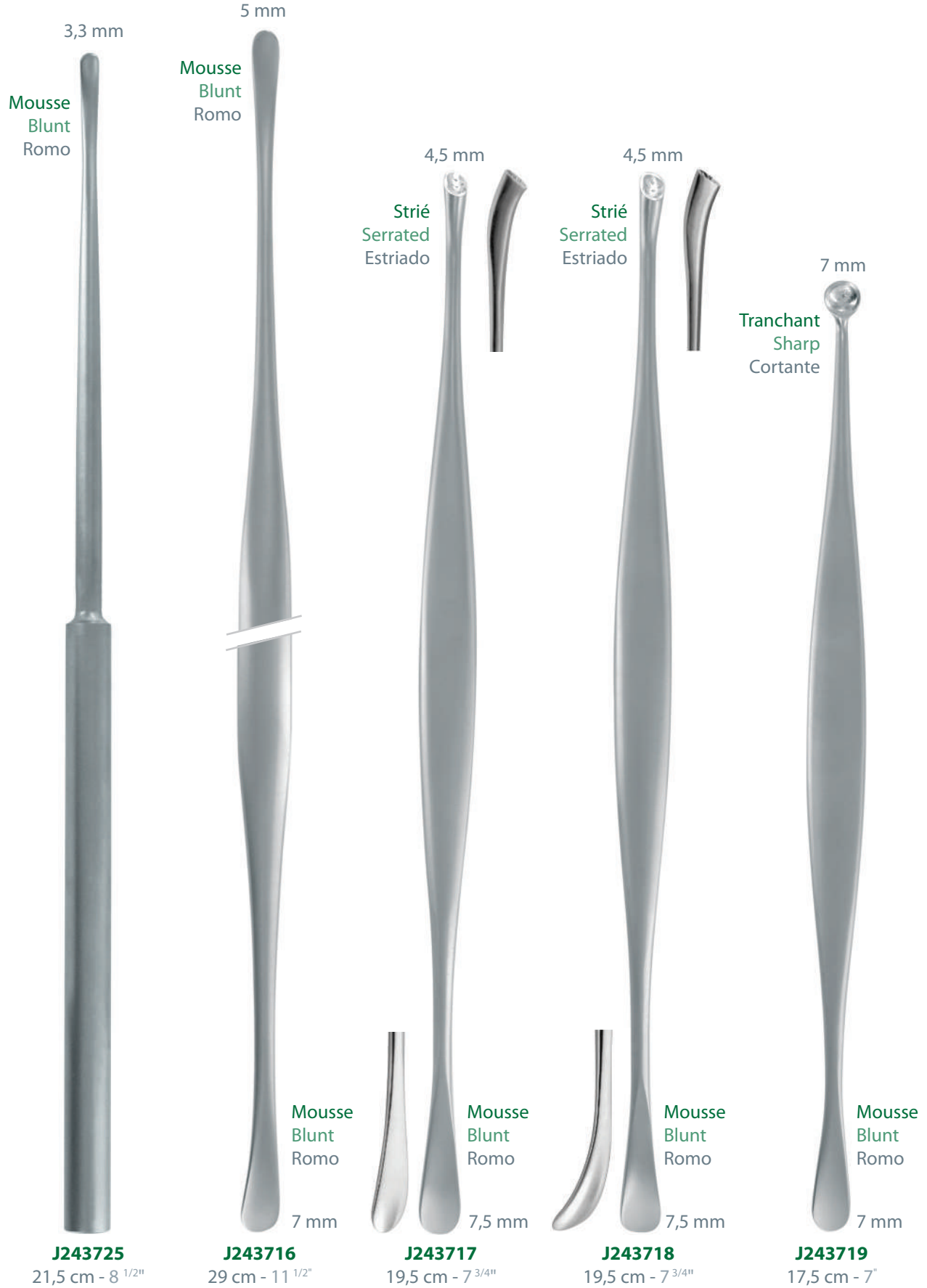

MC DONALD

YASARGIL

COTTLE

WATSON
CHEYNE

TOENNIS

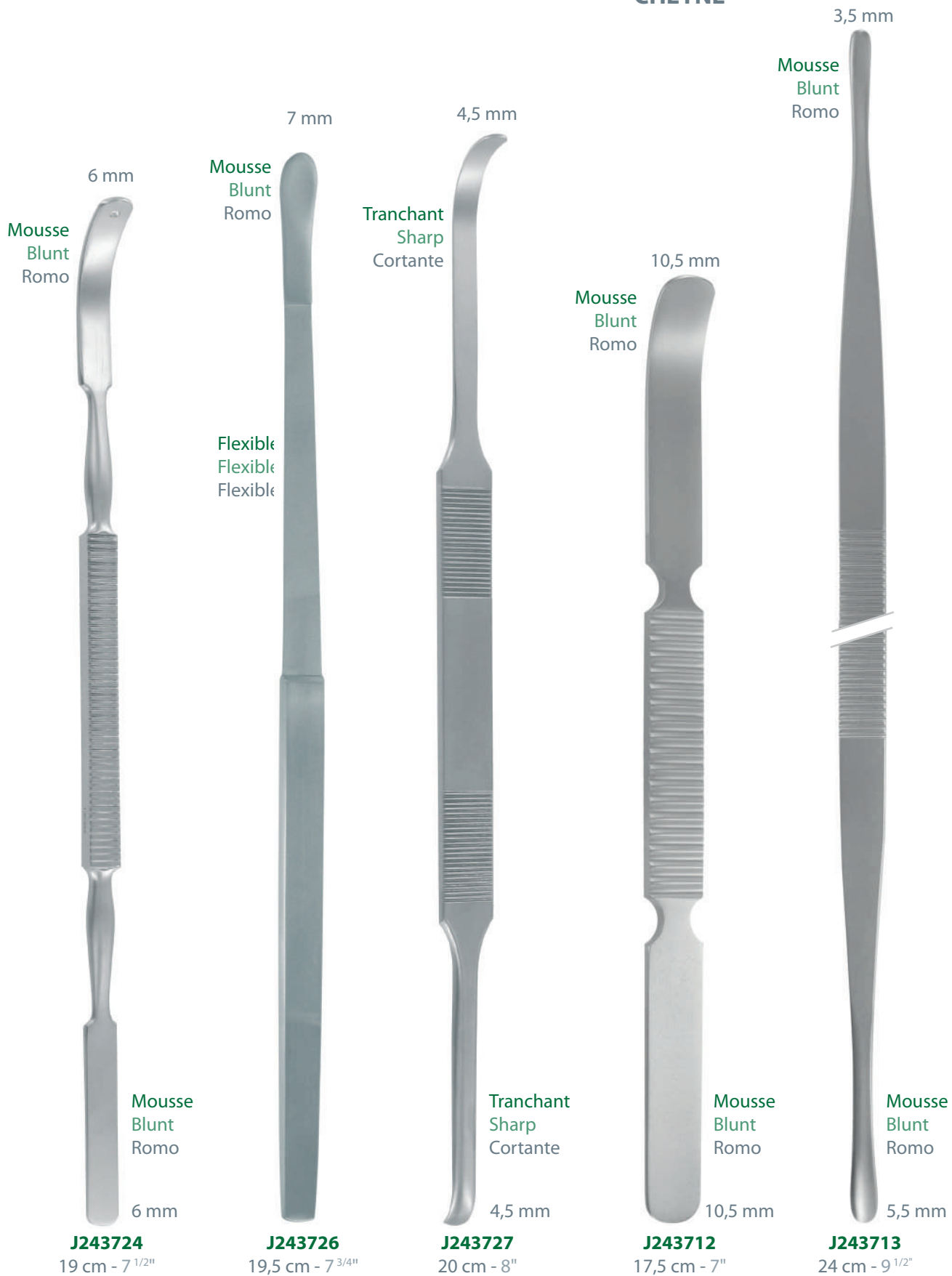

J243724

19 cm - 7 1/2"

J243726

19,5 cm - 7 3/4"

J243727

20 cm - 8"

J243712

17,5 cm - 7"







J243713

24 cm - 9 1/2"



HALLE

ABOULKER

	3,5 mm J16250				4 mm
	5,0 mm J16255 	3,5 mm		4 mm	
	5 mm	Mousse Blunt Romo		Mousse Blunt Romo	Mousse Blunt Romo
3,3 mm	Mousse Blunt Romo				
	Courbe Curved Curvo	Légèrement courbe Slightly curved Ligeramento Curvo		Demi courbe Half curved Medio curvo	Très courbe Very curved Muy curvo
					
J243738	J16255	J162561	J162563	J162565	
18,5 cm - 7 1/4"	20 cm - 8"	21 cm - 8 1/4"	21 cm - 8 1/4"	22 cm - 8 3/4"	

LERICHE



Mousse
Blunt
Romo

5 mm

16 cm - 6 1/4"

J24378 3 mm

J24380 4 mm

J24390 5 mm

J243910 6 mm

J243920 7 mm

20 cm - 8"

J243990 3 mm

J24400 4 mm

J24405 5 mm 

J24410 6 mm

25 cm - 10"

J244130 3 mm

J244140 4 mm

J24415 5 mm

J24420 6 mm

J24425 7 mm

J24405
20 cm - 8"

LANGENBECK

11 mm

8 mm **J244300** 
10 mm **J244310**



Mousse
Blunt
Romo

8 mm

J244300
20 cm - 8"

Mousse
Blunt
Romo



J244320
23 cm - 9"

LEBEAU

YANKAUER

SEBILEAU

HOEN

16 cm - 6 1/4"	J244350	7 mm 
18,5 cm - 7 1/4"	J244360	15 mm
19 cm - 7 1/2"	J244370	20 mm



J162210
18 cm - 7"



J244330
18 cm - 7"



J244340
17 cm - 6 3/4"



J244350
16 cm - 6 1/4"

KÖNIG

WILLIGER

6 mm	J24373 	16 cm - 6 1/4"	J243729	5,0 mm
8 mm	J243731	17 cm - 6 1/4"	J243732	5,5 mm 

4,5 mm
Mousse
Blunt
Romo



J243735
15,5 cm - 6"

4,5 mm



J243735 

4,5 mm



J243736

6 mm
Tranchant
Sharp
Cortante



J24373
16 cm - 6 1/4"

5,5 mm

Mousse
Blunt
Romo



J243732
17 cm - 6 3/4"

4,5 mm
Tranchant
Sharp
Cortante



J243728
12,5 cm - 5"



SEWALL



J080710
20 cm - 8"

SACHS



J081000
21 cm - 8 1/4"

5 mm



J081010
21 cm - 8 1/4"

HORSLEY



J081020
19,5 cm - 7 3/4"

FRAZIER

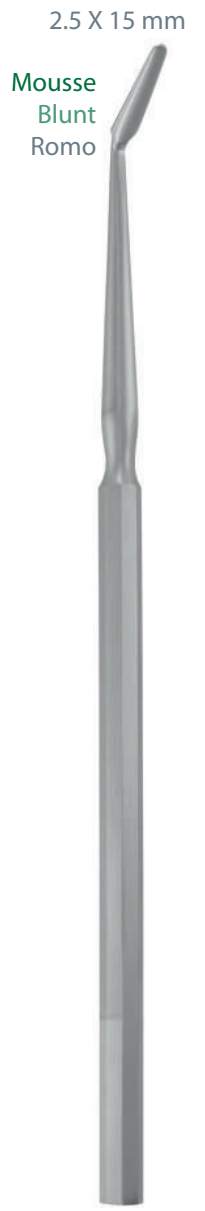

J081030
15 cm - 6"

SICART



J08060
20 cm - 8"

CAIRNS (CLOVIS VINCENT)



J08070
19 cm - 7 1/2"

DE MARTEL



J162200
21 cm - 8 1/4"

PETIT DUTAILLY

Tranchant
Sharp
Cortante



J080900
20 cm - 8"

ADSON

LOVE-ADSON

8 mm

Tranchant
Sharp
Cortante



J241910
17 cm - 6 3/4"

7 mm

Tranchant
Sharp
Cortante



J241912
17 cm - 6 3/4"

7 mm

Mousse
Blunt
Romo



J241911
17 cm - 6 3/4"

7 mm

Tranchant
Sharp
Cortante



J241913
17 cm - 6 3/4"

5,5 mm

Tranchant
Sharp
Cortante



J241915
17 cm - 6 3/4"

MC KENTY

CASPAR

6 mm **J245303**

8 mm **J245304** 

4 mm



J245220
15 cm - 6"

6 mm



J245301
17 cm - 6 ³/₄"

6,2 mm



J245302
18 cm - 7"

8 mm



J245304
17 cm - 6 ³/₄"



MUHLING



J245201
17 cm - 6 ³/₄"



4 mm

J245200



4 mm

J245201

6 mm

I171071



4 mm

J245202



6 mm

J245203



J245210
17,5 cm - 7"



6 mm



J245210



7 mm

J245211



9 mm

J245212



11 mm

J245213

LANDANGER

Rugines - Raspatories - Raspadores

JANSEN



J245110
16,5 cm - 6 1/4"

KRAMER



J245120
19 cm - 7 1/2"

KEY

6 mm	J245130	18 cm - 7"
10 mm	J245131	19 cm - 7 1/2"
13 mm	J245132	19 cm - 7 1/2"
16 mm	J245133	20 cm - 8"
19 mm	J245134	20 cm - 8"
25 mm	J245135	20 cm - 8"

6 mm



J245130
18 cm - 7"

CUSHING



J245137
18,5 cm - 7 1/4"



J245138
18,5 cm - 7 1/4"



PENNYBACKER

- 4 mm **J245139**
- 6 mm **J245140** 
- 8 mm **J245141**

LANGENBECK

16 mm



J245150
19 cm - 7 1/2"

CUSHING

- 5,0 mm **J245145** 
- 7,0 mm **J245146**

5 mm



J245145
19,5 cm - 7 3/4"

MITCHELL

17 mm



J245147
19 cm - 7 1/2"

6 mm

Mousse
Blunt
Romo



J245140
16,5 cm - 6 1/4"

KRAEMER

10 mm



J244900
18,5 cm - 7 1/4"

SEDILLOT

18 mm



J245000
19 cm - 7 1/2"

15 mm



J245010
21 cm - 8 1/4"



COTTLE

8 mm



J245020
19,5 cm - 7 3/4"

FARABEUF

Droite Straight Recta	Largeur Width Anchura	Courbe Curved Curva
J24010	3 mm	J24078
J24020	4 mm	J24080
J24030	6 mm	J24090
 J24040	8 mm	J24100 
J24050	10 mm	J24110
J24060	12 mm	J24120
J24070	14 mm	J24130

OLLIER

Droite Straight Recta	Convexe Convex Convexa	Concave Concave Concava
-----------------------------	------------------------------	-------------------------------

8 mm



J24040

16 cm - 6 1/4"

8 mm



J24100

16 cm - 6 1/4"

10 mm



J24140

16 cm - 6 1/4"

10 mm



J24150

16 cm - 6 1/4"

10 mm



J24160

16 cm - 6 1/4"

DOYEN

Gauche
Left
Izquierdo

Droite
Right
Derecho



J24170
16 cm - 6 1/2"

J24180
16 cm - 6 1/2"

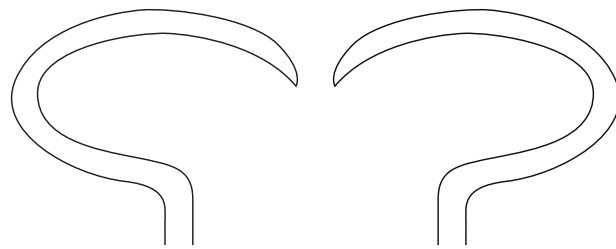

Gauche
Left
Izquierdo

Droite
Right
Derecho



J24170

16 cm - 6 1/2"

J24180



J241810

24 cm - 9 1/2"

J241811

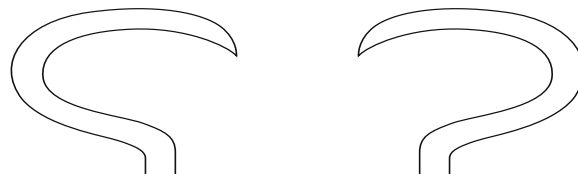

Gauche
Left
Izquierdo

Droite
Right
Derecho

J241690

17 cm - 6 3/4"

J241790



Rugines - Raspatories - Raspadores

Droite Straight Recta **J241906** 

Courbe Curved Curva **J241907**

3 mm **J241902** 

6 mm **J241903**

Tranchant - Sharp - Cortante

Tranchant - Sharp - Cortante



SEMB



J242005
21 cm - 8 1/4"



J242155
22 cm - 8 1/4"



J242160
21,5 cm - 8 1/2"

LANGENBECK



J242170
20,5 cm - 8"



J242180
18 cm - 7"

Tranchant
Sharp
Cortante

ROUX

23 mm **J24360**

26 mm **J24370**



J24360
28 cm - 11"



Rugines - Raspatories - Raspadores

Pour ligament jaune
For yellow ligament
Para ligamento amarillo

7 mm



J24371
20 cm - 8"

CLOVIS-VINCENT

A sciatique
For sciatica
con ciática



6 mm **J08010** 17 cm - 6 ³/₄"
10 mm **J080101** 20 cm - 8"

Courbe
Curved
Curva

6 mm



J08010
17 cm - 6 ³/₄"

Droite
Straight
Recta

J080101

LELIEVRE

Pour les doigts
For fingers
Para los dedos

4 mm **J243705**
4 mm **J243706**

Droite
Straight
Recta

4 mm



J243705
17 cm - 6 ³/₄"

Courbe
Curved
Curva

J243706

MERLE D'AUBIGNE

10 mm

Droite
Straight
Recta



J24192

10 mm

J24193

12 mm

12 mm

Courbe
Curved
Curva



J24194

10 mm

J24195

12 mm

LAMBOTTE

15 mm

6 mm

J24219

10 mm

J24220

12 mm

J24230

15 mm

J24240



18 mm

J24250

20 mm

J24260

25 mm

J24270

J24192
23 cm - 9"

J24195
23 cm - 9"

J24240
21 cm - 8 1/4"





MAURER

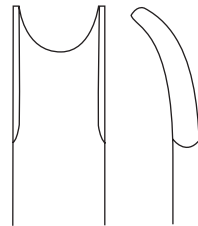

J24280
26 cm - 10 1/4"

En fourche
Forked
Forma de horca



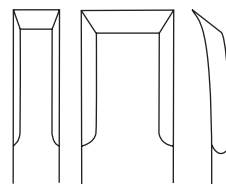

-	6 mm	J24282
 J24280	12 mm	J24284

Droite
Straight
Recta

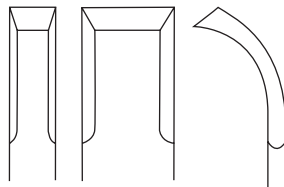

1/2 courbe
Half curved
Medio curva



J24310	6 mm	J24290 
J24320	12 mm	J24300

Courbe
Curved
Curva

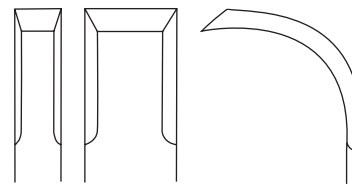

J24290
26 cm - 10 1/4"



COBB

Tranchante - Sharp - Cortante

WAGNER

17 mm

8 mm

 J24374	9 mm	J243775 
J24376	13 mm	J243776
J243770	19 mm	J243777
J243772	25 mm	J243778



9 mm



13 mm

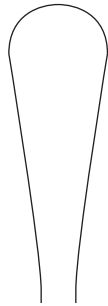

19 mm

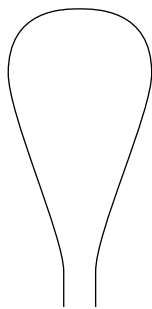

25 mm

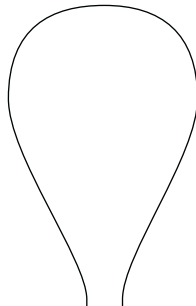

J24376

30 cm - 11 ³/₄"

Tranchant
Sharp
Cortante



J243775

25 cm - 10"

20 mm



J243739

27,5 cm - 10 ³/₄"

Double courbure
Double curvature
Doble curvatura



J244410



J244400

33 cm - 13"

Curettes - Curettes - Curetas

VIDAL

















BROCK

BESNIER

GRATTOIR
SCRAPER
RASPADOR

Pleine
Full
Llena

Fenêtrée
Open work
Con ventana

J28402		2 mm		J28412
J284030		3 mm		J284130
 J28404		4 mm		J28414 
J284050		5 mm		J284150
J284060		6 mm		J284160
J284070		7 mm		J284170
J284080		8 mm		J284180

4 mm
Tranchant
Sharp
Cortant



J28420
13,5 cm - 5 1/4"

4 mm
Mousse
Blunt
Romo



J28425
13,5 cm - 5 1/4"



J28404
13 cm - 5"



J28414
13 cm - 5"



Curettes - Curettes - Curetas

UNNA

MARTINI

WILLIGER

JACOBSON

	2,6 / 3,1 mm	J284279	2,5 / 3,0 mm	J284274 
	3,1 / 4,2 mm	J284280	3,0 / 3,5 mm	J284275
	4,2 / 4,8 mm	J284281	3,5 / 4,2 mm	J284276

Tire-comédon
Comedone extractor
Saca comedone

Fenêtré
Open work
Con ventana



J284260
14 cm - 5 1/2"



J284280
13,5 cm - 5 1/4"



J284274
13,5 cm - 5 1/4"



J284290
13,5 cm - 5 1/4"

Curettes - Curettes - Curetas

JANSEN

VOLKMANN

BARTH

- 13 cm - 5" J284310
- 14 cm - 5 1/2" J284320
- 17 cm - 6 3/4" J284330 
- 20 cm - 8" J284340



J284300
16 cm - 6 1/4"



J284330
17 cm - 6 3/4"



J284350
18,5 cm - 7 1/4"

Curettes - Curettes - Curetas

VOLKMANN



J28060
18 cm - 7"

	17 cm - 6 1/2"	18 cm - 7"	20 cm - 8"	
1 mm	J28005	-	J281507	○
2 mm	J28010	-	J281508	○
3 mm	J28020	-	J281509	○
4 mm	J28030	-	J28151	○
5 mm	J28040	-	J281515	○
6 mm	-	J28050	J28152	○
 7 mm	-	J28060	J281525	○
8 mm	-	J28070	J28153	○
9 mm	-	J28080	J281535	○
10 mm	-	J28090	J28155	○
12 mm	-	J28110	J28156	○
14 mm	-	J28130	J28157	○
16 mm	-	J28150	J28158	○

VOLKMANN

	24 cm - 9 1/2"	28 cm - 11"	
	J281620 4 mm	J282310	
	J28163 6 mm	J28232	
	J28170 8 mm	J28234	
	J28180 10 mm	J28236	
	J28190 12 mm	J28240	
	J28200 14 mm	J28250	
	J28210 16 mm	J28260	
	J28220 18 mm	J28270	
	J28230 20 mm	J28280	
	- 25 mm	J28290	
	- 28 mm	J28300	



J28210
24 cm - 9 1/2"



7 mm
J283450
23 cm - 9"

VOLKMANN

	17 cm - 6 ^{3/4} "	Fig.
2,5 mm	J283001	○ 0000
3,6 mm	J283002	○ 000
4,4 mm	J283003	○ 00
5,2 mm	J283004	○ 0
6,8 mm	J283005	○ 1
 8,5 mm	J283006	○ 2
10,0 mm	J283007	○ 3
11,5 mm	J283008	○ 4
13,0 mm	J283009	○ 5
14,5 mm	J283010	○ 6



J283006
17 cm - 6^{3/4}"

SCHEDE

	17 cm - 6 ^{3/4} "	Fig.
2,5 mm	J283021	○ 000
3,4 mm	J283022	○ 00
4,2 mm	J283023	○ 0
5,2 mm	J283024	○ 1
 6,3 mm	J283025	○ 2
7,4 mm	J283026	○ 3
8,0 mm	J283027	○ 4



J283025
17 cm - 6^{3/4}"

BRUNS

UFFENORDE

Fig. Ø 17 cm - 6 3/4"

○ 3,3 mm **J283100**

○ 4,2 mm **J283101**

○ 5,0 mm **J283102** 

○ 7,0 mm **J283103**

○ 8,5 mm **J283104**

○ 10,0 mm **J283105**

○ 12,5 mm **J283106**

○ 14,0 mm **J283107**

○ 15,0 mm **J283108**

Ronde
Round
Redonda



J283102
17 cm - 6 3/4"

A gauche
To left
A la izquierda

A droite
To right
A la derecha

6,3 mm



J283120

J283110
17 cm - 6 3/4"

CLOWARD

Ovale
Oval
Ovalada



J283404
20 cm - 8"

Droite
Right
Derecho



Coudée
Angular
Angulada



Fig.

○
000

2,0 mm

J283400

J283410

J283420

○
00

2,5 mm

J283401

J283411

J283421

○
0

3,0 mm

J283402

J283412

J283422

○
1

3,5 mm

J283403

J283413

J283423

○
2

4,5 mm

J283404 

J283414

J283424

○
3

5,5 mm

J283405

J283415

J283425

○
4

7,5 mm

J283406

J283416

J283426

○
5

8,5 mm

J283407

J283417

J283427

○
6

10,0 mm

J283408

J283418

J283428

HALLE

Malléable
Malleable
Maleable



Fig.



1

4,8 mm

J283790



2

5,8 mm

J283791



3

6,8 mm

J283792

J283791
21 cm - 8 1/4"



DAUBENSPECK

Coudée
Angular
Angulada



Fig.



00

Ø 2,8 mm

J283800



0

3,6 mm

J283801



1

4,4 mm

J283802



2

5,2 mm

J283803

J283801
20 cm - 8"



LEMPERT



J283812
21,5 cm - 8 1/2"

Droite
Straight
Recta



Fig.

0 1,7 mm **J283810**

0 2,0 mm **J283811**

0 2,4 mm **J283812**

0 2,7 mm **J283813**

0 3,0 mm **J283814**

1



J283821
25 cm - 10"

Droite
Straight
Recta



Fig.

0 **J283820** 3,6 mm **J283830**

0 **J283821** 4,4 mm **J283831**

0 **J283822** 5,2 mm **J283832**

1 **J283823** 6,0 mm **J283833**

Coudée
Angular
Angulada



BRUNS



Tranchante
Sharp
Cortante

Droite
Right
Derecho

Coudée
Angular
Angulada



Fig.	Ø	J283200	J283210	J283220
000	3,3 mm	J283200	J283210	J283220
00	3,9 mm	J283201	J283211	J283221
0	4,7 mm	J283202	J283212	J283222
1	5,3 mm	J283203	J283213	J283223
2	6,0 mm	J283204 	J283214	J283224
3	7,2 mm	J283205	J283215	J283225
4	8,2 mm	J283206	J283216	J283226
5	9,8 mm	J283207	J283217	J283227
6	12 mm	J283208	J283218	J283228

J283204
23 cm - 9"

BUSCHE

Coudée
Angular
Angulada



3 mm **J283233**

4 mm **J283234**

5 mm **J283235**

J283234
25 cm - 10"

SCOVILLE



5,3 mm **J283300**

J283310

J283320

J283300
25 cm - 10"

A sciatique - For sciatica - con ciática

Droite
Right
Derecho



5 mm **J08030**

7 mm **J08031**

J08030
23 cm - 9"

CASPAR

Droite
Right
Derecho

3,6 mm **J283850**

4,4 mm **J283851**

5,2 mm **J283852**

Coudée
Angular
Angulada

3,6 mm **J283860**

4,4 mm **J283861**

5,2 mm **J283862**

Fenêtré
Open work
Con ventana

4 mm **J283840**

5 mm **J283841**

6 mm **J283842**



J283851
22 cm - 8 3/4"



J283861
22 cm - 8 3/4"



J283841
22 cm - 8 3/4"

CHARNLEY



J28350

40 cm - 15 3/4"



LETOURNEL



Curette
Curette
Cureta



J28400

37 cm - 14 1/2"

Ciseau gouge
Gouge
Gubia



J36650

37 cm - 14 1/2"

Burin
Bone chisel
Cinzel



J32675

37 cm - 14 1/2"

LAMBOTTE (PAUWELLS)



2.5 mm



3.2 mm



3.2 mm



3.2 mm

12,5 cm - 5"

16 cm - 6 1/4"

24 cm - 9 1/2"

24 cm - 9 1/2"

Droit
Straight
Recto

Droit
Straight
Recto

Droit
Straight
Recto

Courbe
Curved
Curvo



J32470

16 cm - 6 1/4"

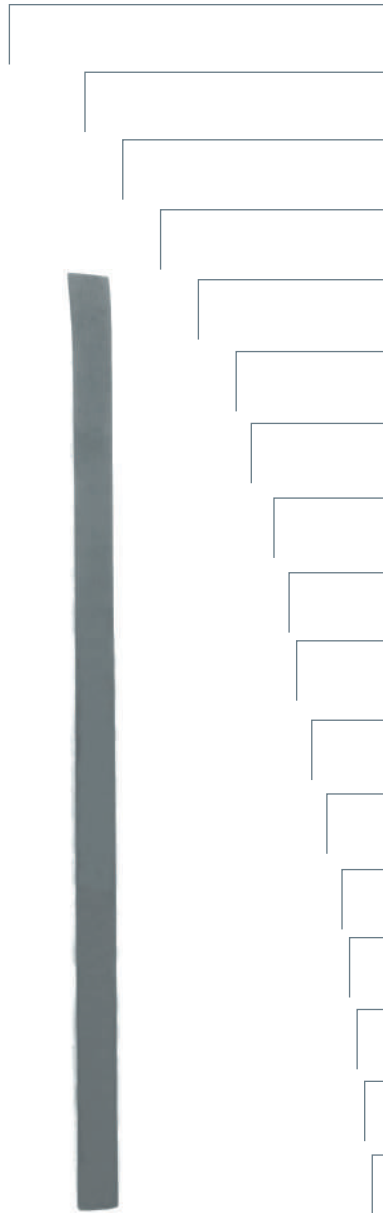

J324623

12,5 cm - 5"

50 mm	-	J32540	J32620	J325430
40 mm	-	J32530	J32610	J325429
35 mm	-	J32520	J32600	J325428
30 mm	-	J32510	J32590	J325427
25 mm	-	J32500	J32580	J325426
20 mm	-	J32490	J32570	J325425
18 mm	-	J324850	J32565	J325424
15 mm	J324627	J32480	J32560	J325423
13 mm	-	J324750	J32555	J325422
12 mm	J324626	-	-	-
10 mm	J324625	J32470	J32550	J325421
8 mm	J324624	J324658	J325455	J325418
6 mm	J324623	-	-	-
5 mm	-	J32465	J325450	J325420
4 mm	J324622	-	-	-
3 mm	J324621	-	-	-
2 mm	J324620	-	-	-







LAMBOTTE

DUPONT

OBWEGESER

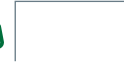
Acier extra dur
Extra hard steel
Acero extra duro



	23 cm - 9"		20 cm - 8"
	J32623	25 mm	J32688
	J32622	20 mm	J32686
 	J32621	15 mm	J32684 
	J32625	10 mm	J32682
	J32624	5 mm	J32678

J32621
23 cm - 9"

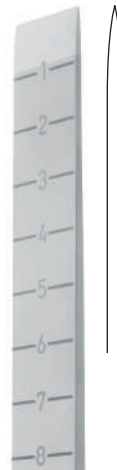

Poignée en "T"
"T" handle
Mango en "T"

J32684
20 cm - 8"

11 mm



J326260
23,5 cm - 9 1/4"

PARTSCH

LUCAS

J320636 6 mm J361536
J320634 4 mm J361534

Burin
Bone chisel
Osea cincela

Gouge
Gouge
Gubia

Burin
Bone chisel
Osea cincela

Gouge
Gouge
Gubia

13,5 cm - 5 1/4"

J320618		8 mm	I170198
J320617		7 mm	I170197
J320616		6 mm	I170196
J320615		5 mm	I170195
J320614		4 mm	I170194
J320613		3 mm	I170193
J320612		2 mm	I170192
-		1 mm	I170191



J320625
17 cm - 6 3/4"

17 cm - 6 3/4"

J320627		7 mm	J361527
J320626		6 mm	J361526
J320625		5 mm	J361525
J320624		4 mm	J361524
J320623		3 mm	J361523



J361525
17 cm - 6 3/4"











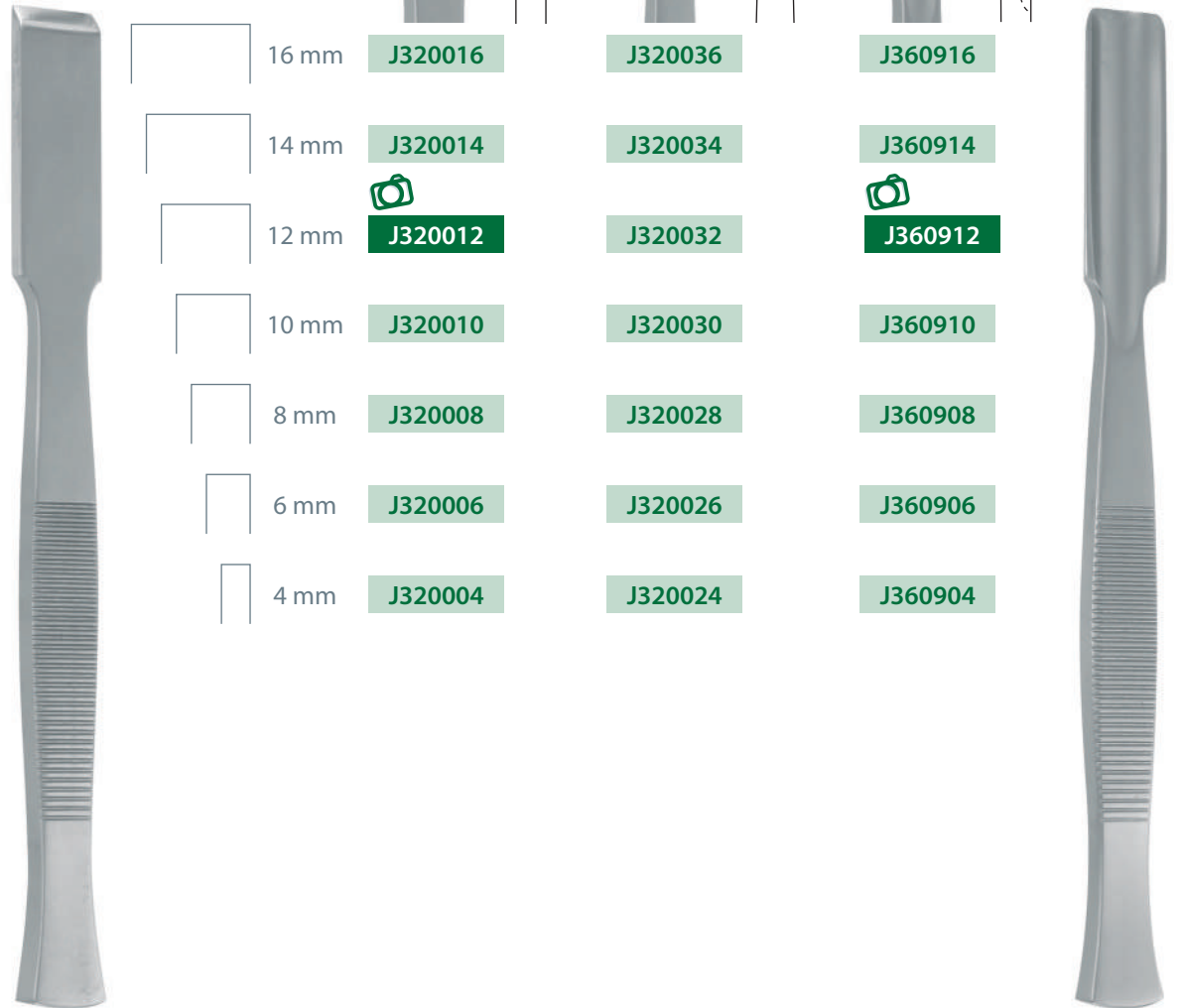

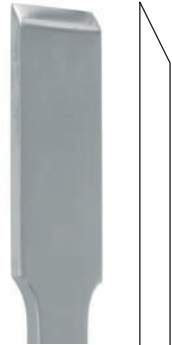

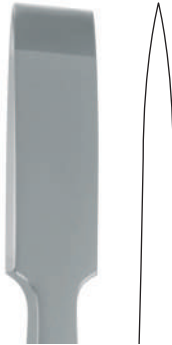

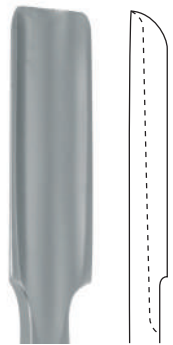

J320634
16 cm - 6 1/4"

J361534
16 cm - 6 1/4"

LANDANGER

Ciseaux burins, ostéotomes, gouges - Bone chisels, osteotomes, gouges - Osea cincelas, osteotomos, gubias

		Burin Bone chisel Osea cincela	Osteotome Osteotome Osteotomo	Gouge Gouge Gubia	
	 16 mm	  J320016	  J320036	  J360916	
	 14 mm	J320014	J320034	J360914	
	 12 mm	 J320012	J320032	 J360912	
	 10 mm	J320010	J320030	J360910	
	 8 mm	J320008	J320028	J360908	
	 6 mm	J320006	J320026	J360906	
	 4 mm	J320004	J320024	J360904	
	J320012 13,5 cm - 5 1/4"				J360912 13,5 cm - 5 1/4"

XIII - Osseux
XIII - Bone surgery
XIII - Cirugía osea

POIRIER

OMBREDANNE

Burin
Bone chisel
Osea cincela

Gouge
Gouge
Gubia

Burin
Bone chisel
Osea cincela

16 cm - 6 1/4"

16 cm - 6 1/4"

14 cm - 5 1/2"



J32060

14 mm

J36150



20 mm

J32420



J32050

12 mm

J36140



15 mm

J32410



J32040

10 mm

J36130



10 mm

J32400



J32030

16 cm - 6 1/4"



J32030

8 mm

J36120



J36130

16 cm - 6 1/4"



J32020

6 mm

J36110



J32010

4 mm

J36100



Lame mince
Thin blade
Hoja fina



J32400

14 cm - 5 1/2"

ALEXANDER

Burin
Bone chisel
Osea cincela

Gouge
Gouge
Gubia



J320650
18 cm - 7"

Burin	Gouge	Width
-	-	32 mm
-	-	25 mm
-	-	19 mm
-	-	16 mm
J320654	J361554	14 mm
-	-	13 mm
J320652	J361552	12 mm
J320650	J361550	10 mm
-	-	9 mm
J320648	J361548	8 mm
J320646	J361546	6 mm
J320644	J361544	4 mm

SMITH-PETERSEN

Osteotome
Osteotome
Osteotomo



J320672
20,5 cm - 8"

Osteotome	Osteotome	Width
J320676	J320686	32 mm
J320675	J320685	25 mm
J320674	J320684	19 mm
J320673	J320683	16 mm
-	-	14 mm
J320672	J320682	13 mm
-	-	12 mm
-	-	10 mm
J320671	J320681	9 mm
-	-	8 mm
J320670	J320680	6 mm
-	-	4 mm

SMITH-PETERSEN

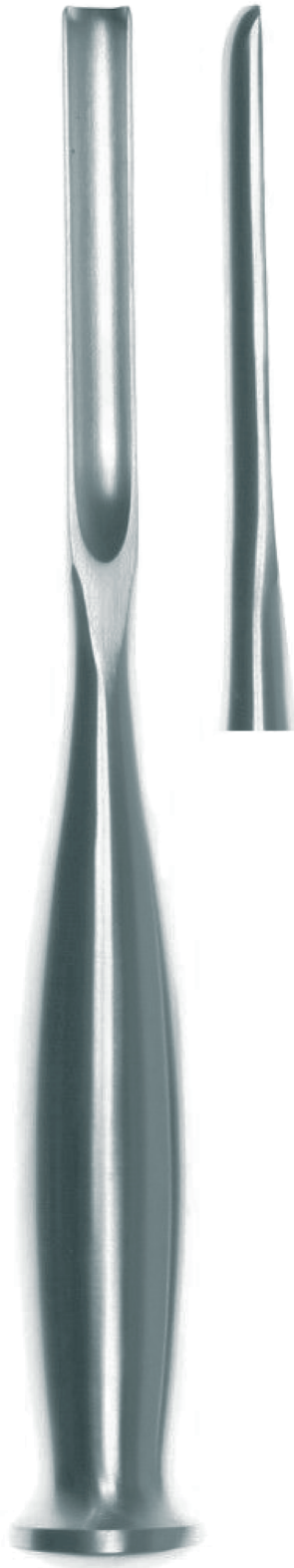

J363311
20,5 cm - 8"

J363310	6 mm	J363320
J363311	9 mm	J363321
J363312	13 mm	J363322
J363313	16 mm	J363323
J363314	19 mm	J363324
J363315	25 mm	J363325
J363316	32 mm	J363326

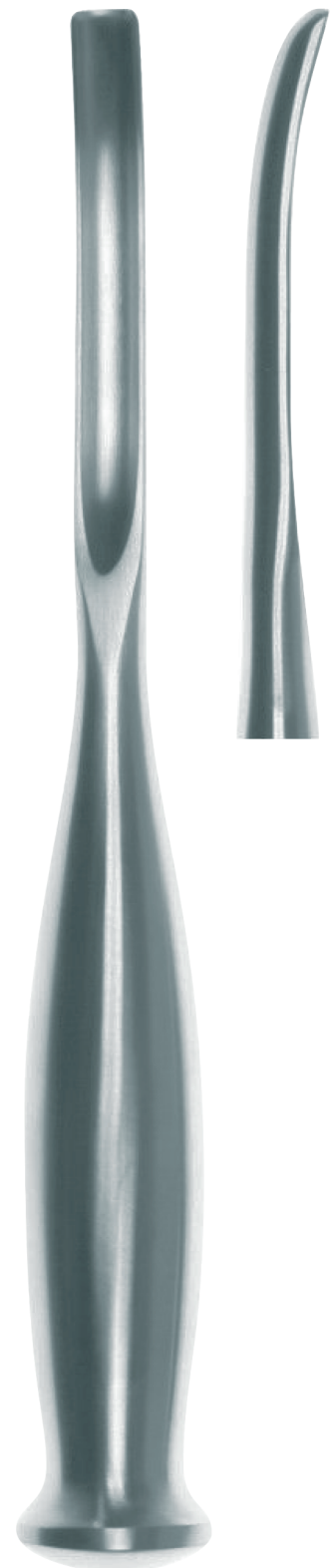

J363321
20,5 cm - 8"

LANDANGER

Ciseaux burins, ostéotomes, gouges - Bone chisels, ostéotomes, gouges - Osea cincelas, osteotomos, gubias

STILLE

Lame mince
Thin blade
Hoja fina

12 mm

12 mm

21 cm - 8 1/4"

		Droit Straight Recto	Droit Straight Recto	Courbe Curved Curvo	Droit Straight Recto	Droit Straight Recto
30 mm		J32310	J327030	J327230	-	J36250
25 mm		J32300	J327025	J327225	J326925	J36240
20 mm		J32290	J327020	J327220	J326920	J36230
15 mm		J32280	J327015	J327215	J326915	J36220
12 mm		J32270	J327012	J327212	J326912	J36210
10 mm		J32260	J327010	J327210	J326910	J36200
8 mm		J32250	J327008	J327208	-	J36190
6 mm		J32240	J327006	J327206	-	J36180
25 cm - 10"						
30 mm		J32390	J327130	-	-	J36330
25 mm		J32380	J327125	-	-	J36320
20 mm		J32370	J327120	-	-	J36310
15 mm		J32360	J327115	-	-	J36300
12 mm		J32350	J327112	-	-	J36290
10 mm		J32340	J327110	-	-	J36280
8 mm		J32330	J327108	-	-	J36270
6 mm		J32320	J327106	-	-	J36260

J32270

21 cm - 8 1/4"

J36210

21 cm - 8 1/4"



LUCAS

Burin
Bone chisel
Osea cincela



J32235

21 cm - 8 1/4"

HIBBS

Osteotome
Osteotome
Osteotomo

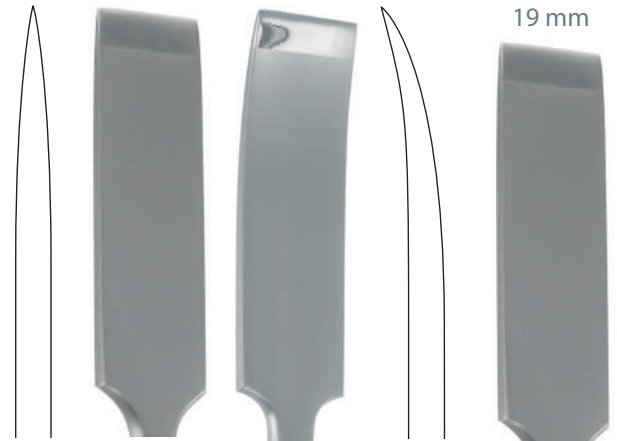

24 cm - 9 1/2"

24 cm - 9 1/2"

Droit
Straight
Recto

Courbe
Curved
Curvo

38 mm	J326909	J326899
32 mm	J326908	J326898
28 mm	J326907	J326897
25 mm	J326906	J326896
22 mm	J326905	J326895
19 mm	J326904	J326894
16 mm	J326903	J326893
13 mm	J326902	J326892
9 mm	J326901	J326891
6 mm	J326900	J326890

J326904

24 cm - 9 1/2"

MAC EVEN

10 mm

Osteotome
Osteotome
Osteotomo



15 mm **J32440**

10 mm **J32430**

Droit
Straight
Recto

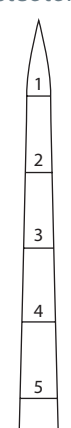

15 mm **J32460**

10 mm **J32450**

Courbe
Curved
Curvo

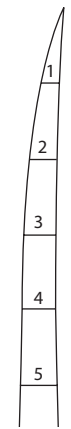

J32430
21 cm - 8 1/4"

JUDET

15 mm

Burin
Bone chisel
Osea cincela

40 mm **J320740**

35 mm **J320735**

30 mm **J320730**

25 mm **J320725**

20 mm **J320720**

15 mm **J320715**

10 mm **J320710**

Droit
Straight
Recto



18 mm **J320768**

16 mm **J320766**

12 mm **J320762**

Courbe
Curved
Curvo



J320715
22 cm - 8 3/4"

FARABEUF

Burin
Bone chisel
Osea cincela

15 mm



J32190
25 cm - 10"

Gouge
Gouge
Gubia

14 mm



J36600
25 cm - 10"

25 cm - 10"

30 mm	J32220	J320815	-	-
25 mm	J32210	J320814	-	-
20 mm	J32200	J320813	-	-
15 mm	J32190	J320812	-	-
14 mm	-	-	-	J36600
12 mm	J32170	-	-	J36590
10 mm	J32160	J320810	-	J36580
8 mm	J32150	-	-	J36570
6 mm	J32140	-	-	J36560
21 cm - 8 1/4"				
30 mm	J321102	J320805	J328030	-
25 mm	J321101	J320804	J328025	-
20 mm	J32110	J320803	J328020	-
15 mm	J32100	J320802	J328015	-
12 mm	J320993	-	J328012	-
10 mm	J320992	J320800	J328010	-
8 mm	J320991	-	J328008	-
6 mm	J320990	-	J328006	-

LANDANGER

Ciseaux ostéotomes, gouges - Osteotomes, gouges - Osteotomos, gubias

CAUCHOIX

Osteotome
Osteotome
Osteotomo

Gouge
Gouge
Gubia

20 mm

16 mm

25 cm - 10"

		Osteotome	Convexe	Concave
		Convexe	Convexe	Concave
		Osteotomo	Convexa	Concava
	25 mm	J32665	-	-
	20 mm	J32660	J36430	J36370
	18 mm	J32650	J36420	J36360
	16 mm	J32640	J36410	J36350
	14 mm	J32630	-	-
	12 mm	J32629	-	-
	10 mm	J32628	-	-
	8 mm	J32627	-	-
30 cm - 11 3/4"				
	20 mm	-	J36460	J36400
	18 mm	-	J36450	J36390
	16 mm	-	J36440	J36380

J32650
25 cm - 10"

J36410
25 cm - 10"



XIII - Osseux
XIII - Bone surgery
XIII - Cirugía ósea

GUILLAUME

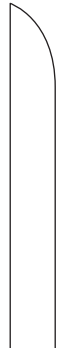

8 mm



J36040



7 mm

J36030



6 mm

J36020



5 mm

J36044



4 mm

J36042

J36040
25 cm - 10"

NANCY



10 mm

J36080



8 mm

J36070



6 mm



J36060

J36060
27 cm - 10 3/4"

SMITH PETERSEN

30 mm



J36345



27 mm



J36340

22 mm



J36335

Modèle Lyon
Lyon's mode
Modelo Lyon

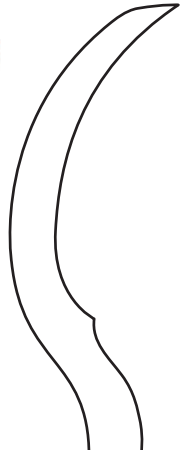





J36345
23,5 cm - 9 1/4"

HONTON

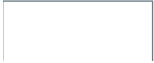

J364718

30 cm - 11 3/4"

		Droit Straight Recta	Convexe Convexe Convexa	Concave Concave Concava
30 cm - 11 3/4"				
	20 mm	J364720	J364920	J364820
	18 mm	J364718 	J364918	J364818
	16 mm	J364716	J364916	J364816
	14 mm	J364714	J364914	J364814



STAGNARA



J36635
30 cm - 11 ³/₄"

Très courbe
Very curved
Muy curva

Droite
Straight
Recta

1/2 Courbe
Half Curved
Media curva

Courbe
Curved
Curva

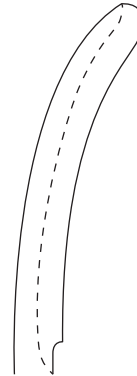
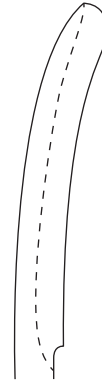
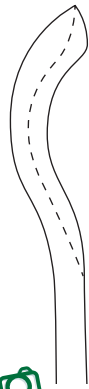

30 cm - 11 ³/₄"

	16 mm	J36635			
	14 mm	J36625	-	-	-
	12 mm	J36620	-	-	-
	10 mm	J366190	-	-	-
	8 mm	J366180	J36700	J36705	J36710
	6 mm	J366170	-	-	-

MANCHE ANTIDÉRAPANT
ANTISLIPING HANDLE
MANGO ANTIDESLIZANTE



J36700
30 cm - 11 ³/₄"



LANDANGER

Ciseaux ostéotomes, gouges - Osteotomes, gouges - Osteotomos, gubias

MINI LEXER



J329010
22 cm - 8^{3/4}"

Osteotome
Osteotome
Osteotomo



18 cm - 7"	12 mm	18 cm - 7"
J328912		J368912
J328910	10 mm	J368910
J328908	8 mm	J368908
J328906	6 mm	J368906
J328904	4 mm	J368904



J369010
22 cm - 8^{3/4}"

Gouge
Gouge
Gubia



LEXER

22 cm - 8 ^{3/4} "	30 mm	22 cm - 8 ^{3/4} "
J329030		J369030
J329025	25 mm	J369025
J329020	20 mm	J369020
J329015	15 mm	J369015
J329010	10 mm	J369010
J329007	7 mm	J369007
J329005	5 mm	J369005

LEXER

Gouge
Gouge
Gubia

Gouge
Gouge
Gubia

Burin
Bone chisel
Osea cincela

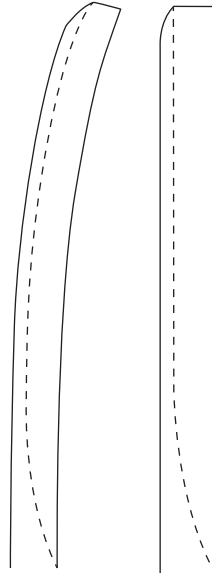

-	15 mm	J369215	J369315
J369110	10 mm	J369210	J369310
J369105	5 mm	J369205	J369305

J369105
28 cm - 11"

J369310
25 cm - 10"

J329120
24,5 cm - 9 3/4"

J329130
26,5 cm - 10 1/2"

CAPENER

ZIELKE

Pour retirer les vis cassées
For removing the broken screws
Para retirar tornillos rotos



- 16 mm **J369416**
- 13 mm **J369413**
- 11 mm **J369411**
- 8 mm **J369408**
- 6 mm **J369406** 

J369406
23,5 cm - 9 1/4"



- 9 mm **J369429**
- 5,5 mm **J369425** 

J369425
23 cm - 9"



J369440
22 cm - 8 3/4"

PUTTI



J244670
27 cm - 10 1/2"



J244680
30 cm - 12"



J244705
22 cm - 9"

2 faces
2 sides
2 lados

Demi ronde
Half round
Mitad redonda



J244650
25 cm - 10"



J24466
28 cm - 11"

1 face
1 side
1 lado

Maillets - Mallets - Martillos

OMBREDANNE

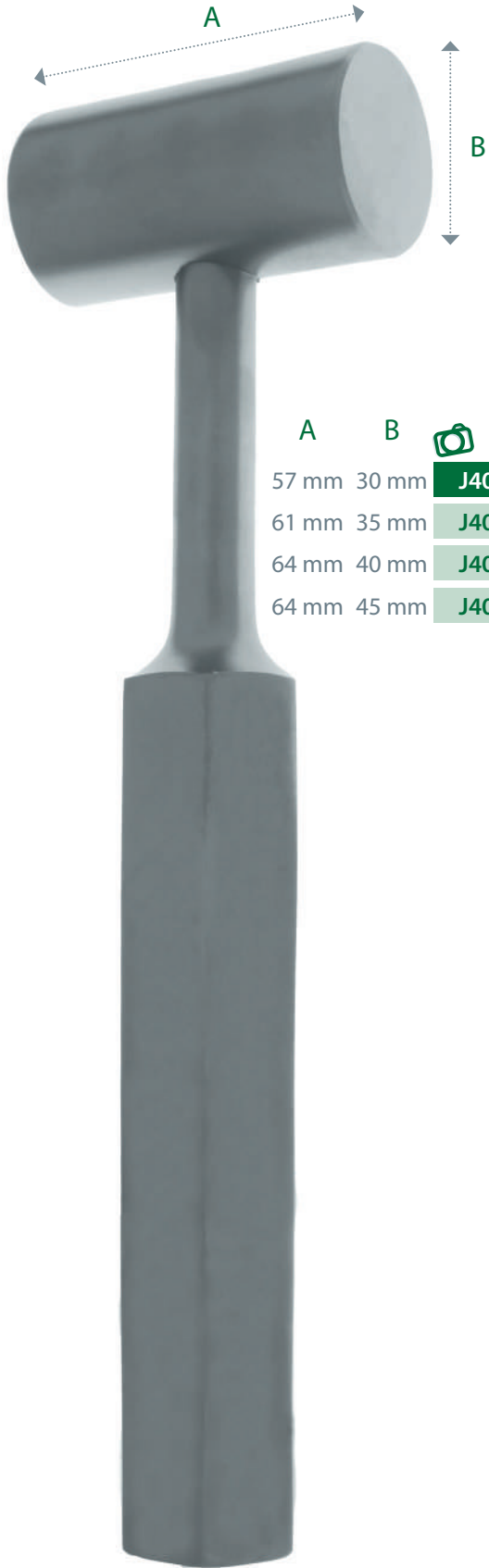

A	B	Code	Weight
57 mm	30 mm	J40010	500 g
61 mm	35 mm	J40020	700 g
64 mm	40 mm	J40025	900 g
64 mm	45 mm	J40030	1200 g

J40010
22 cm - 8 3/4"

A B

38 mm	22 mm	J400010	170 g
-------	-------	---------	-------

Tête avec insert en plomb
Head with lead insert
Cabeza con inserto de plomo



J400010
19 cm - 7 1/2"

PARTSCH

A	B	Code	Weight
36 mm	22 mm	J400020	115 g



J400020
18 cm - 7"

MAC EVEN

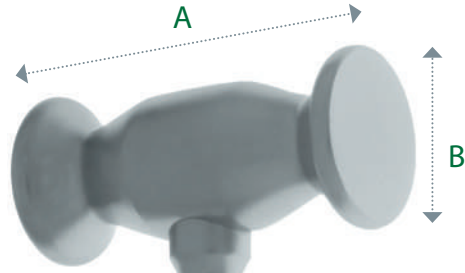
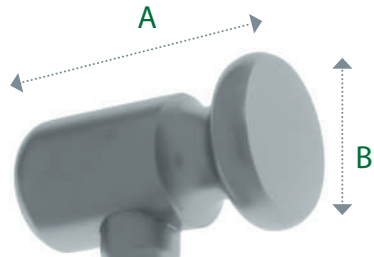

A	B		
40 mm	25 mm	 J40040	250 g
45 mm	30 mm	J40045	400 g
52 mm	35 mm	J40050	500 g
60 mm	40 mm	J40055	700 g

A	B		
52 mm	25 mm	 J40060	250 g
50 mm	30 mm	J40070	350 g
48 mm	35 mm	J40075	500 g
52 mm	40 mm	J40080	600 g
52 mm	45 mm	J40090	750 g

J40040
22 cm - 8 1/2"

J40060
22 cm - 8 1/2"

Maillets - Mallets - Martillos

BERGMANN

A B
60 mm 30 mm **J400950** 300 g



J400950
23 cm - 9"

LUCAE

A B 
46 mm 19 mm **J401500** 130 g
52 mm 25 mm **J401505** 170 g



J401500
19 cm - 7 1/2"

HAJEK

A B
44 mm 27 mm **J401600** 140 g



J401600
21,5 cm - 8 1/2"

 Aluminium
Aluminum
Aluminio

MEAD

A B
60 mm 30 mm **J401700** 230 g

A B
60 mm 26 mm **J401800** 170 g

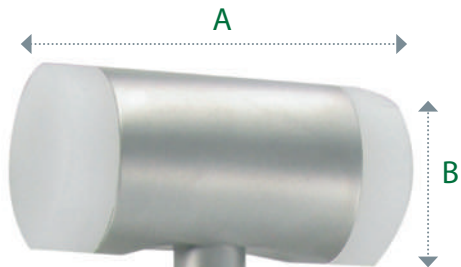

Paire de disques interchangeable
Pair of interchangeable discs
Par de discos intercambiables

J401710

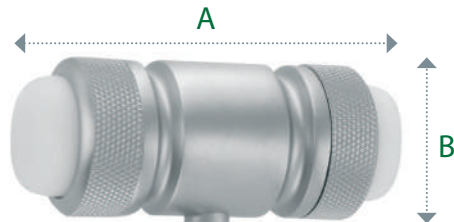

Paire de disques interchangeable
Pair of interchangeable discs
Par de discos intercambiables

J401810

J401700
24,5 cm - 9 3/4"

J401800
17 cm - 6 3/4"

COTTLE

LOMBARD

A	B	Model	Weight
50 mm	30 mm	J401405	240 g
55 mm	25 mm	J401400	135 g
47 mm	20 mm	J401000	350 g

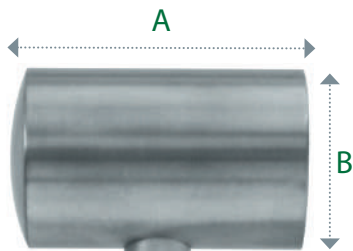

Convexe
Convexe
Convexa

Plat
Flat
Plato

J401405
19 cm - 7 1/2"

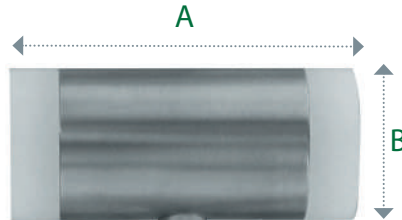

Paire de disques
interchangeables
Pair of
interchangeable disks
Par de discos
intercambiales

J401401

J401400
19 cm - 7 1/2"

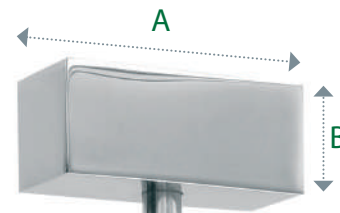

J401000
20 cm - 8"

! Aluminium
Aluminum
Aluminio

JUDET



20 cm - 8"

J401180 600 g

25 cm - 10"

J401190 800 g

 **J40120** 1000 g

J40120
25 cm - 10"

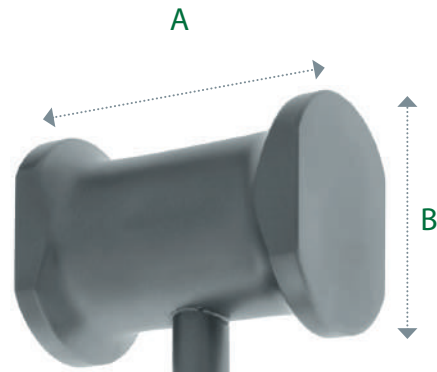

A **B** 23 cm - 9"

65 mm 30 mm **J401300** 180 g

24 cm - 9 1/2"

65 mm 35 mm **J401301** 350 g 

68 mm 45 mm **J401302** 500 g

75 mm 50 mm **J401303** 700 g

J401301
24 cm - 9 1/2"

ISSELIN

Avec œillet
With hole
Con agujero

2,5 mm **J440070**

Sans œillet
Without hole
Sin agujero

2,5 mm **J440075** 



J440075
16,5 cm - 6 1/2"

OMBREDANNE

Pointe carrée
Square point
Punta cuadrada

16 cm - 6 5/16"

2 mm **J44032**

3 mm **J44035**

4 mm **J44010** 

5 mm **J44020**

3 mm



J44005
13 cm - 5 1/8"



J44010
16 cm - 6 5/16"



J44060
22 cm - 8 3/4"

Pointe carrée
Square point
Punta cuadrada

22 cm - 8 3/4"

3 mm **J44040**

4 mm **J44050**

5 mm **J44060** 

6 mm **J44066**

7 mm **J44070**

25 cm - 10"

3 mm **J44045**

4 mm **J44055**

5 mm **J44065**

6 mm **J44068**

7 mm **J44071**

MERLE D'AUBIGNE







Pointe triangulaire
Triangular point
Punta triangular

- Ø 22 cm - 8 ³/₄"
- 3 mm **J44075**
 - 4 mm **J44085**
 - 5 mm **J44100** 
 - 6 mm **J44105**
 - 7 mm **J44110**

J44100
22 cm - 8 ³/₄"



Pointe quadrangulaire
Quadrangular point
Punta cuadrangular

- 22 cm - 8 ³/₄"
-  4 mm **J44115**
 -  5 mm **J44116** 
 -  6 mm **J44117**

J44116
22 cm - 8 ³/₄"

PERTHES

Pointe carrée
Square point
Punta cuadrada

18 cm - 7"

- 3 mm **J440723**
- 4 mm **J440724**
- 5 mm **J440725** 
- 6 mm **J440726**
- 8 mm **J440728**



J440725
18 cm - 7"



Pointe triangulaire
Triangular point
Punta triangular

25 cm - 10"

- Ø 3 mm **J441113** 
- Ø 4 mm **J441114**
- Ø 5 mm **J441115**



J441113
25 cm - 10"



Aluminium
Aluminum
Aluminio



J441200
22 cm - 8 1/2"

ROCHER

15 cm - 6"	J44121 
18 cm - 7"	J44122
20 cm - 8"	J44123



J44121
15 cm - 6"

FICAT

Ø 8 mm	J442008 
Ø 10 mm	J442010
Ø 12 mm	J442012



J442008
34,5 cm - 13 1/2"



KOENING

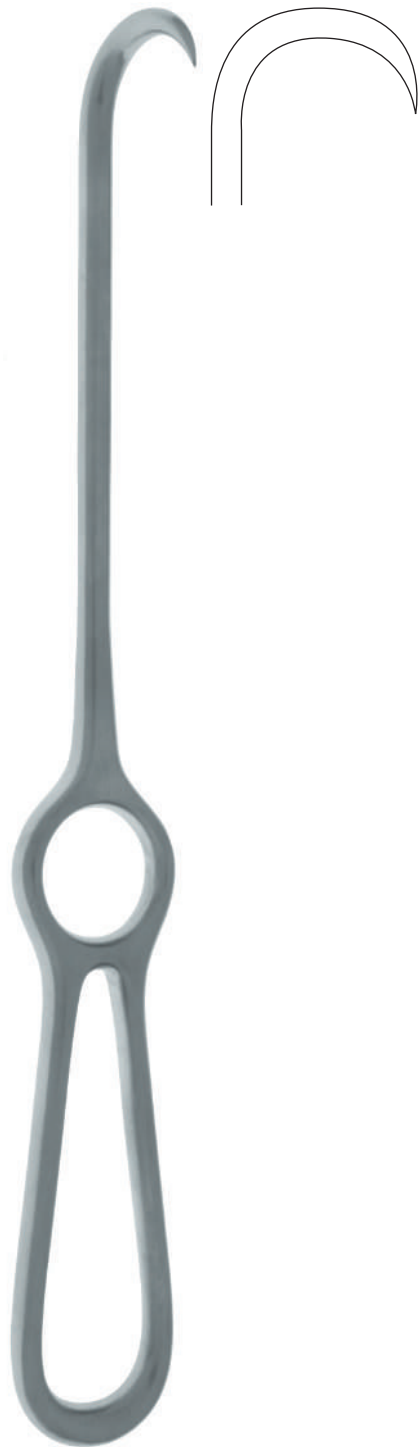

J48020
24 cm - 9 1/2"

LAMBOTTE

- 23 cm - 9" **J48030** 
- 25 cm - 10" **J48040**
- 27 cm - 10 3/4" **J48050**

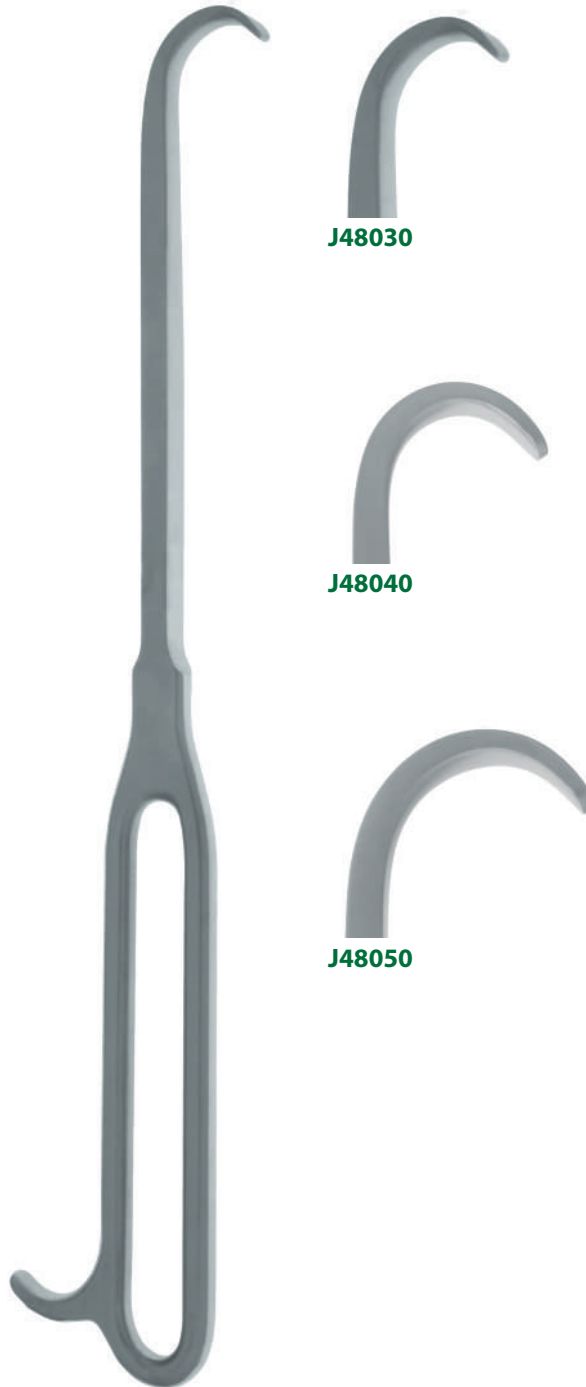

J48030

J48040

J48050

J48030
23 cm - 9"



Réglet inox
Stainless ruler
Regla inoxidable

- 15 cm - 6" **J560350**
- 20 cm - 8" **J56040** 
- 30 cm - 11 3/4" **J56050**
- 50 cm - 19 3/4" **J56055**



Pied à coulisses inox
Stainless caliper
Calibre de medición

Dispositifs non médicaux
Not medical devices
Dispositivos no médicos



Non compatible avec les traitements
de nettoyage/stérilisation
No compatible with treatments
for cleaning/sterilization
No compatible con los tratamientos
de limpieza/esterilización

J56040
20 cm - 8"

J56070
23 cm - 9"

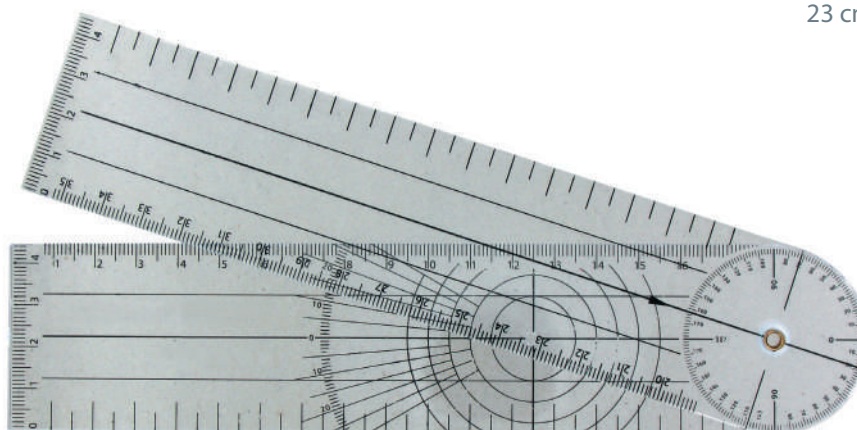













Goniomètre
Goniometer
Goniometro

J561200
20 cm - 8"

LANDANGER

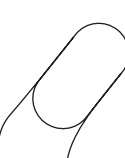
Pinces gouges - Bone rongeur forceps - Pinzas gubias

	17 cm - 6 3/4"		17 cm - 6 3/4"
Droite Straight Recta		Courbe Curved Curva	
	5 mm J64020		5 mm J64060 
			
	7 mm J64030		7 mm J64070
			
	9 mm J64040 		9 mm J64080
	20 cm - 8"		20 cm - 8"
			
	8 mm J64090		8 mm J64120
J64040 17 cm - 6 3/4"		J64060 17 cm - 6 3/4"	
	10 mm J64100		10 mm J64130

LOMBARD

Mors carrés
Quadrangular jaws
Bocas cuadradas



Droite
Straight
Recta



J64150 

Courbe
Curved
Curva

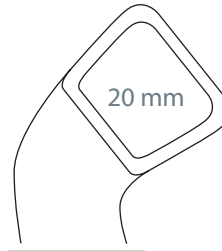

J64160

Coudée
Angular
Acodada



3 mm

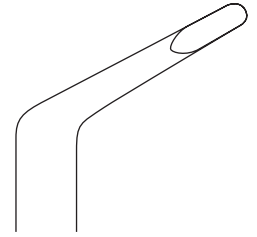

J64260
18 cm - 7"

J64150
23 cm - 9"

LANDANGER

Pinces gouges - Bone rongeur forceps - Pinzas gubias

VINCENT



J64290
20 cm - 8"

Mors courts
Short jaws
Bocas cortas

6 mm

Courbe
Curved
Curva



20 cm - 8"

J64310

24 cm - 9 1/2"

J64350

Courbe
Curved
Curva

20 cm - 8"

J64290



24 cm - 9 1/2"

J64330

Mors longs
Long jaws
Bocas largas

4 mm



Droite
Straight
Recta

4 mm



25 cm - 10"

J64340

SICARD

Droite
Straight
Recta

6 mm



J64380
23 cm - 9"

ABOULKER

Droite
Straight
Recta

5 mm



J643810
24 cm - 9 1/2"

Courbe latérale
Curved laterally
Curva lateral

8 mm



J64270
17 cm - 6 3/4"



LUER-FRIEDMANN

MINI-FRIEDMANN

FRIEDMANN DELIKAT

Courbe
Curved
Curva

2,5 mm



J64400
14 cm - 5 1/2"

Courbe
Curved
Curva

2,5 mm



J644005
12,5 cm - 5"

Courbe
Curved
Curva

2 mm



J644010
15 cm - 6"



Pinces gouges - Bone rongeur forceps - Pinzas gubias

BLUMENTHAL

Légèrement Courbe
Lightly curved
Ligeramenta curva

Courbe
Curved
Curva

Coudée
Angular
Acodada

3 mm



J644990



3 mm



J644995

3 mm



J644996

MEAD

Mors ronds
Round jaws
Bocas redondas

Mors carrés
Square jaws
Bocas cuadradas

5 mm



J645200

4 mm



J645205



J644990

15,5 cm - 6"

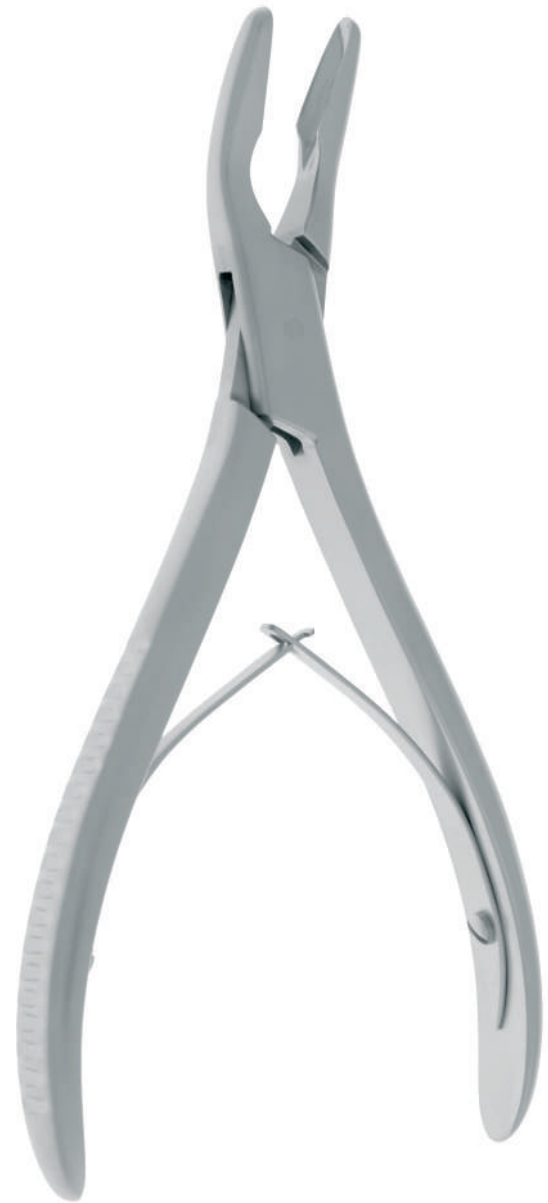

J645200

16,5 cm - 6 1/2"

LANDANGER

Pinces gouges - Bone rongeur forceps - Pinzas gubias

LUER

CLEVELAND

HAKANSSON

3 mm

Courbe
Curved
Curva



J644890

4 mm



J64490

Courbe
Curved
Curva

4 mm



J644880



14 cm - 5 1/2"

J644885

17 cm - 6 1/4"

Courbe latérale
Laterally curved
Curva lateral

5 mm



J644880

14 cm - 5 1/2"

J644875

15,5 cm - 6"

J64490

15 cm - 6"



Pinces gouges - Bone rongeur forceps - Pinzas gubias

LUER

Droite
Straight
Recta

Courbe
Curved
Curva

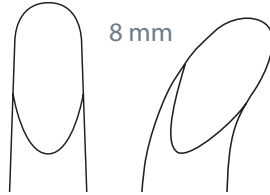

8 mm

J644950

J644960



17 cm - 6^{3/4}"

Modèle fort
Heavy pattern
Modelo fuerte

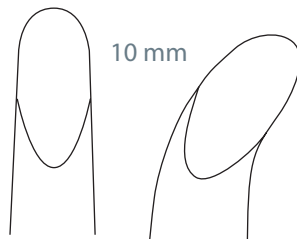

10 mm

J644970

J644980

18,5 cm - 7^{1/4}"



J644960
17 cm - 6^{3/4}"

ADSON

Droite
Straight
Recta

8 mm

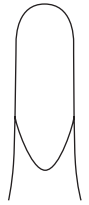

J644984

8 mm

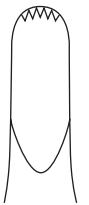

J644986

Dentelées
Saw edge
Dentadas

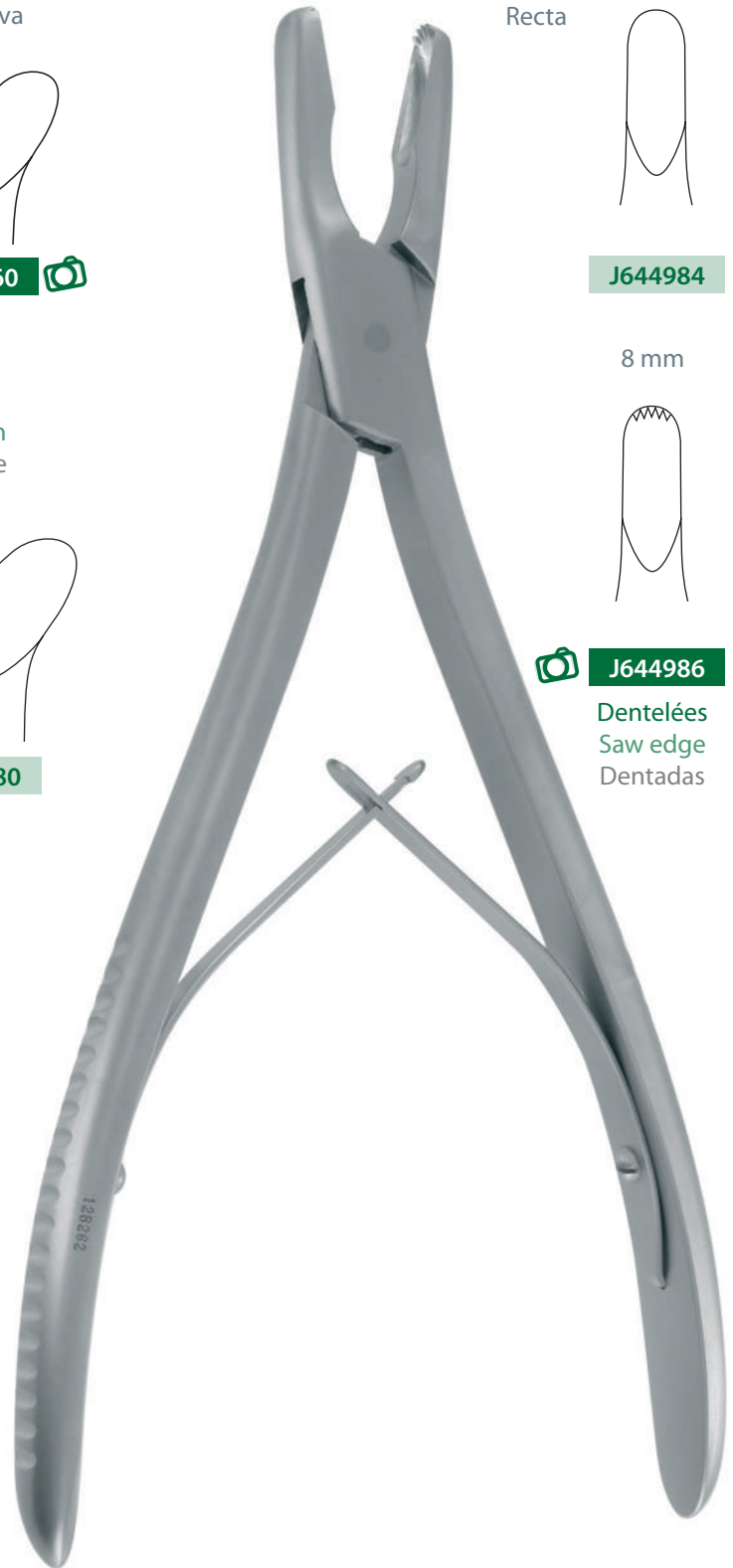

J644986
20 cm - 8"

STELLBRINK

Courbe
Curved
Curva

2 mm



J645000

2 mm

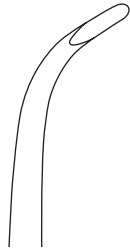

J645010



BANE HARTMANN

Courbe
Curved
Curva

3 mm



J645210
17,5 cm - 7"

JANSEN

Droite
Straight
Recta

4 mm



J645110

Courbe
Curved
Curva

4 mm



J645120



J645010
17,5 cm - 7"



J645110
17,5 cm - 7"

OLIVECRONA



J645100
20 cm - 8"

BEYER



J645215
18 cm - 7"

LEMPERT



J64192
19 cm - 7 1/2"

19 cm - 7 1/2"

J64190

J64192



J64190

J64192

NORTHFIELD

Courbe latérale
Curved laterally
Curva lateral

9 mm



J645230
20,5 cm - 8"

PENNYBACKER

Droite
Straight
Recta

4 mm

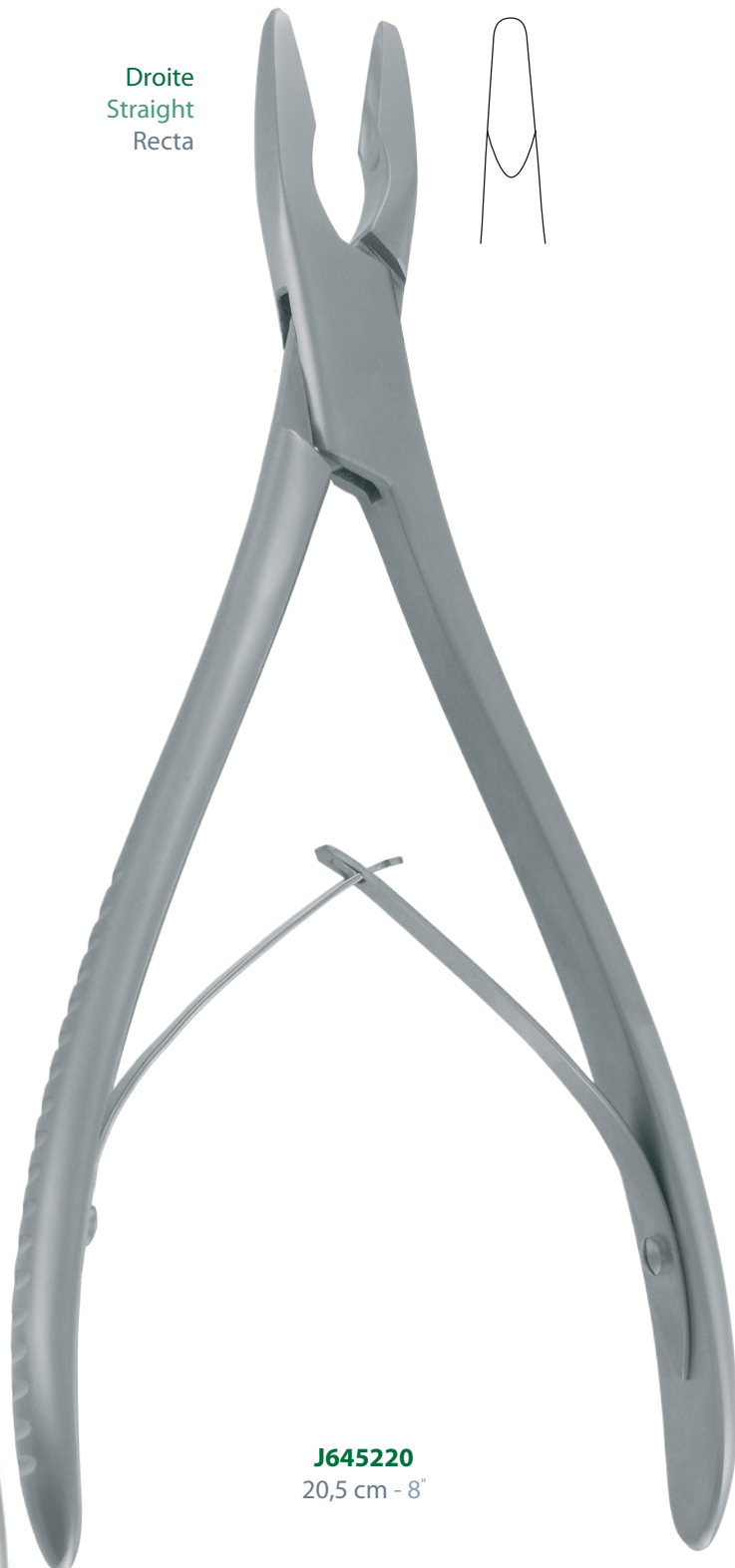

J645220
20,5 cm - 8"



JANSEN

Mors baïonnette
Bayonet jaws
Bocas bayoneta



J645235
18 cm - 7"

STOOKEY

Courbe latérale
Curved laterally
Curva lateral

4 mm

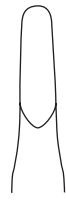

J645240
18,5 cm - 7 1/4"

BACON

Courbe latérale
Curved laterally
Curva lateral

8 mm



J645245
20 cm - 8"

BOEHLER

3 mm



Droite
Straight
Recta

J64384



3 mm



Courbe
Curved
Curva

J64386

2 mm



J64385



J64384
15 cm - 6"

BEYER-ZAUFAL

5 mm



Courbe
Curved
Curva



J64480
18 cm - 7"

BEYER

2,5 mm



J643950

18 cm - 7"

Courbe
Curved
Curva



J64390
18 cm - 7"

4 mm



J64390



6 mm



J64410

20 cm - 8"

MARQUARDT

Courbe
Curved
Curva

3 mm



J644850
20 cm - 8"

MAYFIELD

Courbe
Curved
Curva

3 mm



J644830
17 cm - 6 3/4"

RUSKIN

Droite
Straight
Recta

6 mm

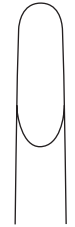

J645250

Courbe
Curved
Curva

6 mm



J645251



J645251
18 cm - 7"

STILLE

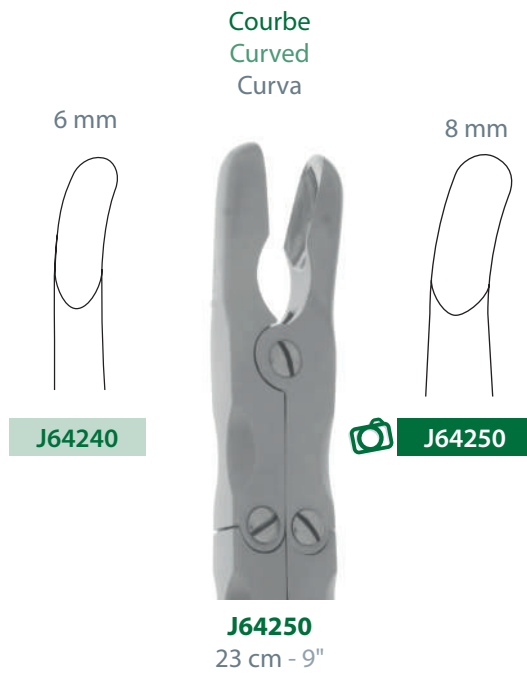

RÖTTGEN-RUSKIN

4 mm
 Courbe
 Curved
 Curva



SMITH-PETERSEN

LEKSELL- STILLE

3 mm

Coudée latérale
 Angular laterally
 Acodada lateral



J64416

6 mm

Courbe
 Curved
 Curva



5 mm

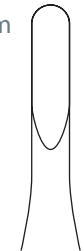

J64418

8 mm

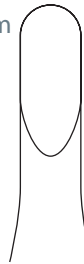

J64422

10 mm

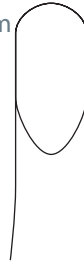

J644230



J644870
 24 cm - 9 1/2"



J64412

19 cm - 7 1/2"

J64414

23 cm - 9"



J64416
 24 cm - 9 1/2"

ECHLIN

FRYKHOLM

Coudées latérales
Angular laterally
Acodadas laterale



2 mm

3 mm

J64254

J64256

J64254
23 cm - 9"



4 mm

J642570
24 cm - 9 1/2"

SAUERBRUCH

Droite
Straight
Recta

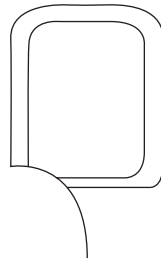

20 mm

J64280

31 cm - 12 1/4"

DAVID

Coudée latérale
Angular laterally
Acodada lateral



6 mm



J64370

26 cm - 10 1/4"

LANDANGER

Pinces gouges - Bone rongeur forceps - Pinzas gubias

SEMB

STILLE-LUER

Courbe
Curved
Curva

18 mm

17 mm

Droite
Straight
Recta



J645310

17 mm

Courbe
Curved
Curva

J645315

J645300
23 cm - 9"

J645310
27 cm - 10 1/2"



XIII - 115

LISTON

Double doigt
Double Collin's lock
Doble articulación

Droite
Straight
Recta

-	14 cm - 5 1/2"	J68022
-	17 cm - 6 3/4"	J68026 
	J68062	19 cm - 7 1/2"
J68066	22 cm - 8 3/4"	J68050

Coudée
Angular
Acodada

-	14 cm - 5 1/2"	J68024
-	17 cm - 6 3/4"	J68028
J68064	19 cm - 7 1/2"	J68040
J68068	22 cm - 8 3/4"	J68060



J68062
19 cm - 7 1/2"

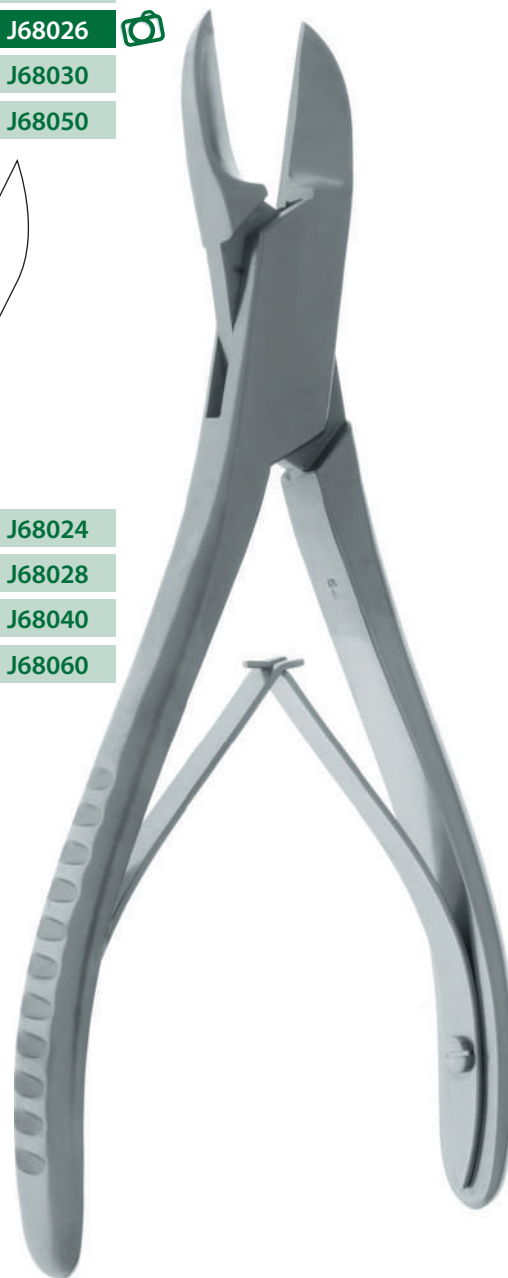

J68026
17 cm - 6 3/4"

LITTAUER-LISTON

CLEVELAND

KAZANJIAN

Coudée
Angular
Acodada

13 cm - 5" **J680710**

17 cm - 6 3/4" **J680715** 



Droite
Straight
Recta



Droite
Straight
Recta



J680715
17 cm - 6 3/4"

J680700
15 cm - 6"

J680720
18,5 cm - 7 1/4"



RUSKIN-LISTON

Droite
Straight
Recta



 **J68275**

Coudée
Angular
Acodada



J68280



J68275
19 cm - 7 1/2"

BOEHLER

Droite
Straight
Recta



 **J68010**

Coudée
Angular
Acodada



J68012



J68010
15 cm - 6"

MAC INDOE

Coudée
Angular
Acodada



17 cm - 6 3/4"

 **J68015**

19 cm - 7 1/2"

J68020



J68015
17 cm - 6 3/4"

LISTON

Droite
Straight
Recta

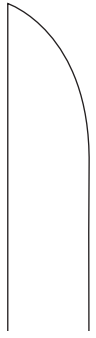

J68090

Coudée
Angular
Acodada



J68100

Droite
Straight
Recta

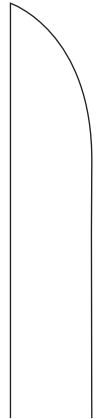

J681190

Courbe - Forte
Curved - Strong
Curva - Fuerte



J68120



J68090
24 cm - 9 1/2"



J68120
28 cm - 11"

LISTON-KEY (HORSLEY)

SEMB



Contre-coudée - Forte
Conterbent - Strong
Curva doble - Fuerte

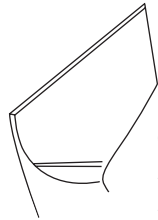

Coudée
Angular
Acodada

J68110
26 cm - 10 1/4"



Courbe à gauche
Left Curved
Curva de izquierda



Coudée
Angular
Acodada

J681090
24 cm - 9 1/2"

LANDANGER

Costotomes - Costotomes - Costotomos

COLLIN

Enfants
Children
Niños

17 cm - 6 ³/₄"

J68170

Adultes
Adults
Adultos

19 cm - 7 ¹/₂"

J68180



A doigt
Collin's lock
Demontable



J68180
19 cm - 7 ¹/₂"

LISTON

Cisaille
Shear
Cizalla

19 cm - 7 ¹/₂"

J68150

25 cm - 10"

J68130



A doigt
Collin's lock
Demontable



J68130
25 cm - 10"

J681900
22 cm - 8 ³/₄"



BETHUNE





J681605
34 cm - 13 1/2"

MAURER

A droite
Right curved
Derecha



J68240
24 cm - 9 1/2"

	A droite Right curved Derecha	À gauche Left curved Izquierda
24 cm - 9 1/2"	 J68240	J68230
31 cm - 12 1/4"	 J68210	J68220

A droite
Right curved
Derecha



A doigt
Collin's lock
Demontable

J68210
31 cm - 12 1/4"

BRUNNER

Pour main droite
For right hand
Para mano derecha

Pour main gauche
For left hand
Para mano izquierda



J681615

J681610

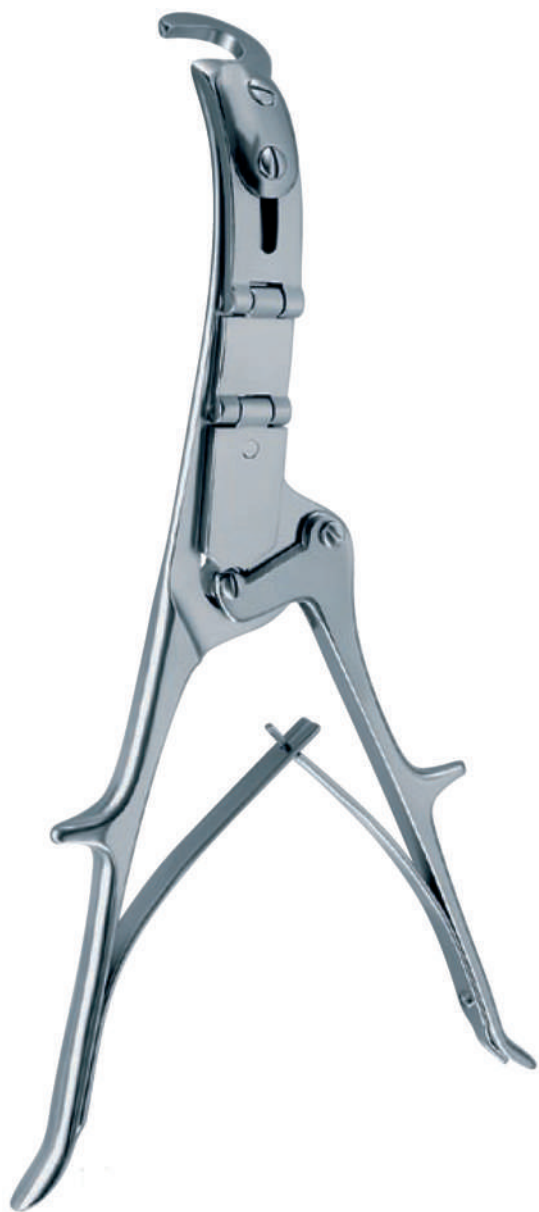

J681615
32 cm - 12 1/2"

GLUCK



J681620
22 cm - 8 3/4"

GIERTZ-STILLE



J681630
25 cm - 10"



SAUERBRUCH

SAUERBRUCH-FREY

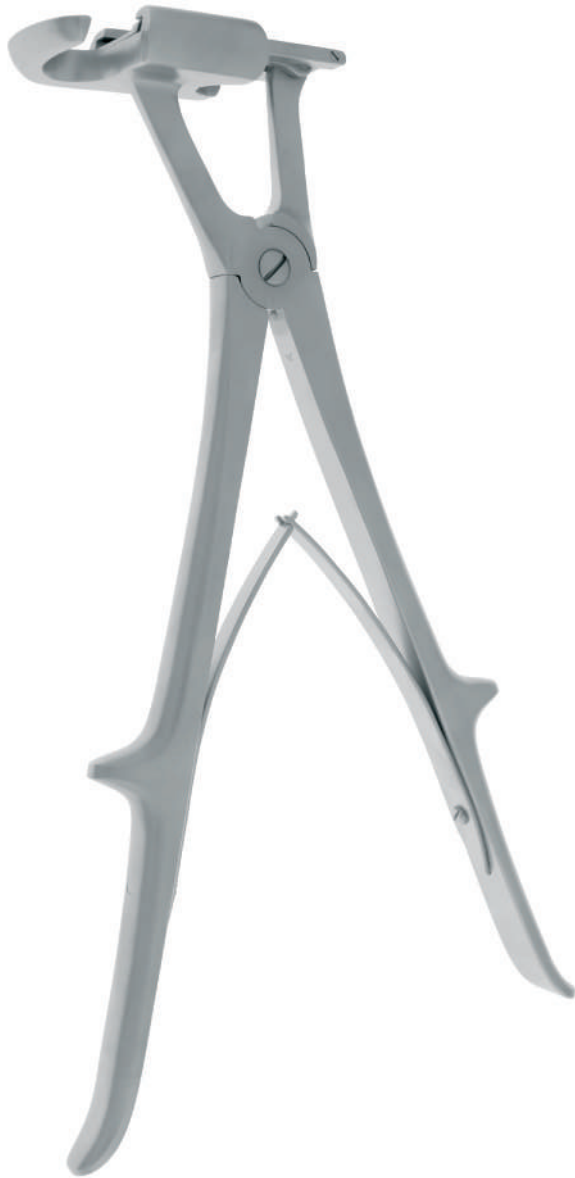

J681600
26 cm - 10 1/4"



J681601
36 cm - 14 1/4"

VELPEAU (TRICOISE)



A doigt
Collin's lock
Demontable

J68250
24 cm - 9 1/2"

DOYEN



A doigt
Collin's lock
Demontable

J68260
18 cm - 7"

LEBSCHÉ

Sternotome
Sternum chisel
Cinzel par esternón



J68270
24 cm - 9 1/2"

Daviers - Bone holding forceps - Pinzas para huesos

Réducteurs
Reducing
Reductor

Préhenseur
Prehensile
Prensador

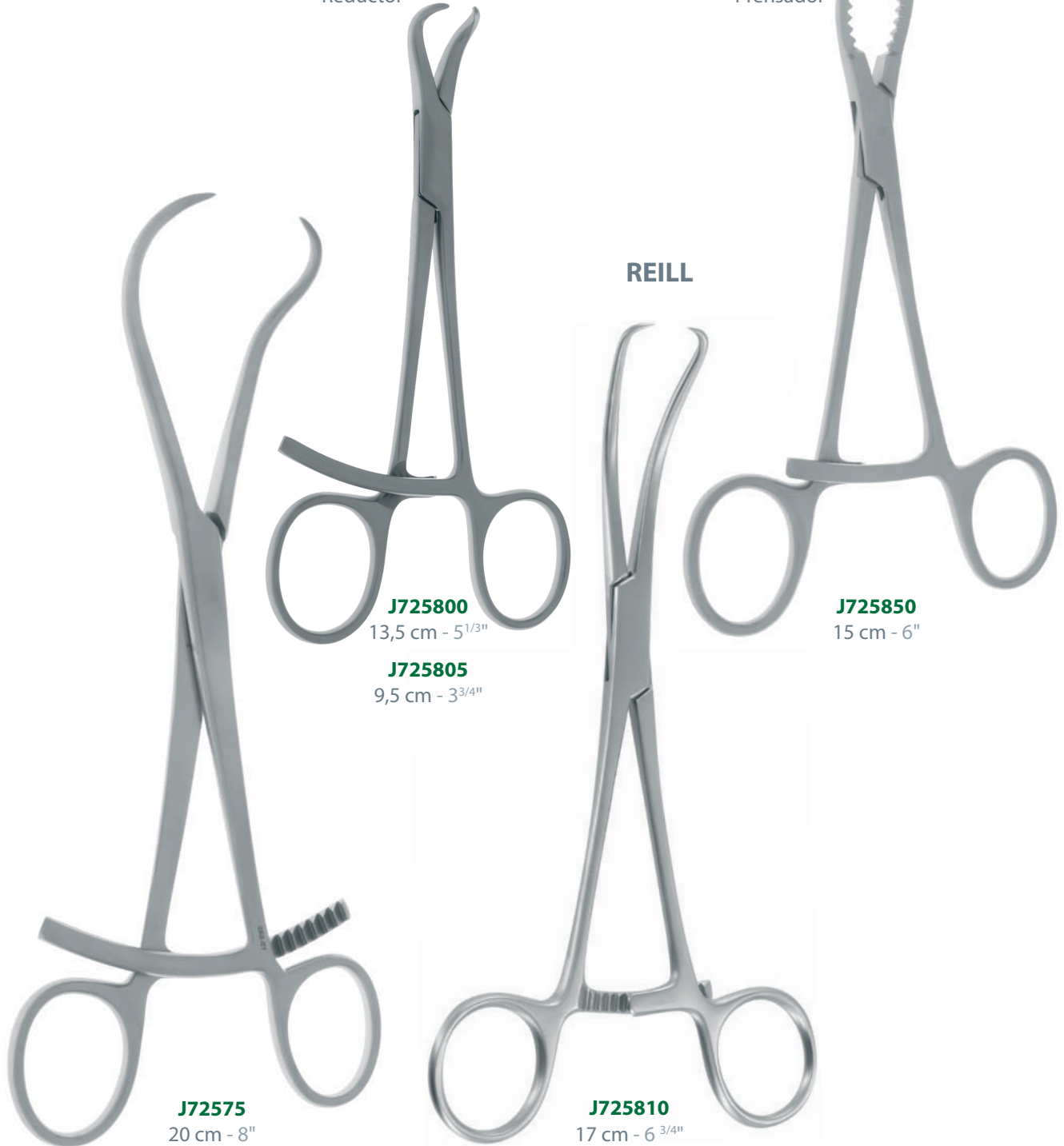

Réducteurs : 2 mors pointus
Reducing : 2 sharped jaws
Reductor : 2 bocas aceradas

Préhenseur : 2 mors dentés
Prehensile : 2 toothed jaws
Prensador : 2 bocas dentadas

DINGMANN



J721901
19 cm - 7 1/2"



J72190
19 cm - 7 1/2"

Pour os de la main
For hand bones
Para huesos de la mano

Préhenseur
Prehensile
Prensador



J72010
15 cm - 6"

VERBRUGGE

Préhenseur
Prehensile
Prensador



J72350
16 cm - 6 1/4"

Réducteurs
Reducing
Reductor

Réducteurs
Reducing
Reductor



J72400
16 cm - 6 1/4"

J72400
16 cm - 6 1/4"

Réducteurs	: 1 mors denté	1 mors acéré
Reducing	: 1 toothed jaw	1 sharpened jaw
Reductor	: 1 boca dentada	1 boca acerada

Préhenseur	: 2 mors dentés
Prehensile	: 2 toothed jaws
Prensador	: 2 bocas dentadas

LANDANGER



J72595
26 cm - 10 1/4"

Préhenseur
Prehensile
Prensador



Humérus
Humerus
Humero

26 cm - 10 1/4"

J72600



Tibia
Tibia
Tibia

J72595



Fémur
Femur
Femur

J72590

Réducteurs
Reducing
Reductor



Humérus
Humerus
Humero

26 cm - 10 1/4"

J72612



Tibia
Tibia
Tibia

J72610



Fémur
Femur
Femur

J72605

Porte-plaque
Plate holder
Porta placa



Humérus
Humerus
Humero

26 cm - 10 1/4"

-



Tibia
Tibia
Tibia

12 mm

J72615

Fémur
Femur
Femur

16 mm

Réducteurs : 1 mors denté 1 mors acéré
Reducing : 1 toothed jaw 1 sharpened jaw
Reductor : 1 boca dentada 1 boca acerada

Préhenseur : 2 mors dentés
Prehensile : 2 toothed jaws
Prensador : 2 bocas dentadas

VERBRUGGE



J72360
18 cm - 7"

Préhenseur
Prehensile
Prensador



J72355

15 cm - 6"

Réducteurs
Reducing
Reductor



J72405



J72360

18 cm - 7"



J72410



J72370

24 cm - 9 1/2"



J72420



J72380

26 cm - 10 1/4"



J72430



J72390

28 cm - 11"

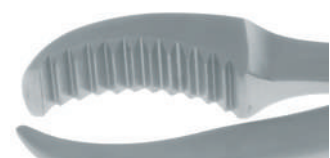

J72440

Réducteurs	: 1 mors denté	1 mors acéré
Reducing	: 1 toothed jaw	1 sharped jaw
Reductor	: 1 boca dentada	1 boca acerada

Préhenseur	: 2 mors dentés
Prehensile	: 2 toothed jaws
Prensador	: 2 bocas dentadas



Daviers - Bone holding forceps - Pinzas para huesos

VERBRUGGE

1 mors mobile
1 moving jaw
1 boca móvil L

Porte-plaque
Plate holder
Porta placa

24 cm - 9 1/2"	J72490	25 mm
26 cm - 10 1/4"	J72500	30 mm
28 cm - 11"	J72510	38 mm

24 cm - 9 1/2"	J72460	10 mm
26 cm - 10 1/4"	J72470	13 mm
28 cm - 11"	J72480	16 mm

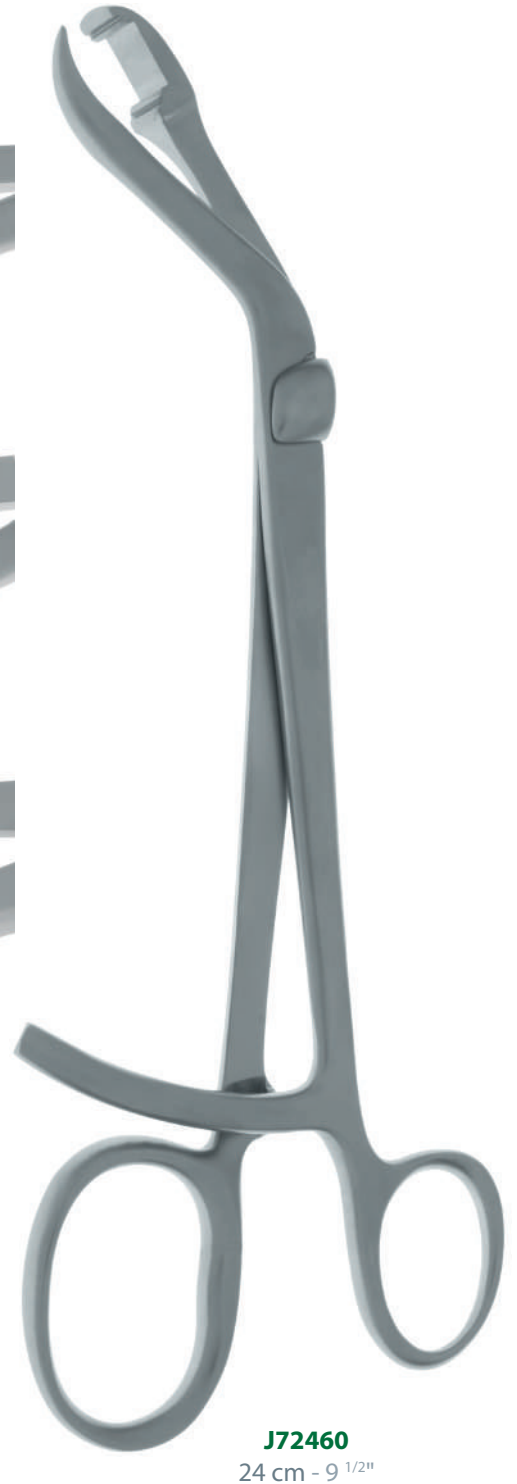
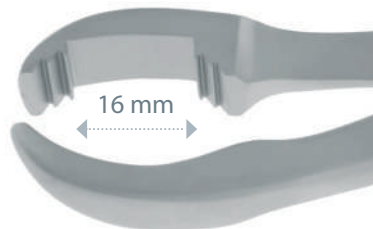
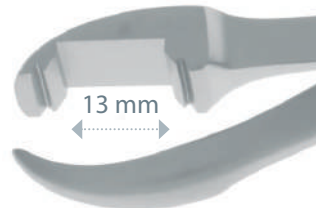
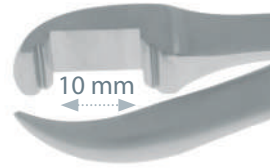
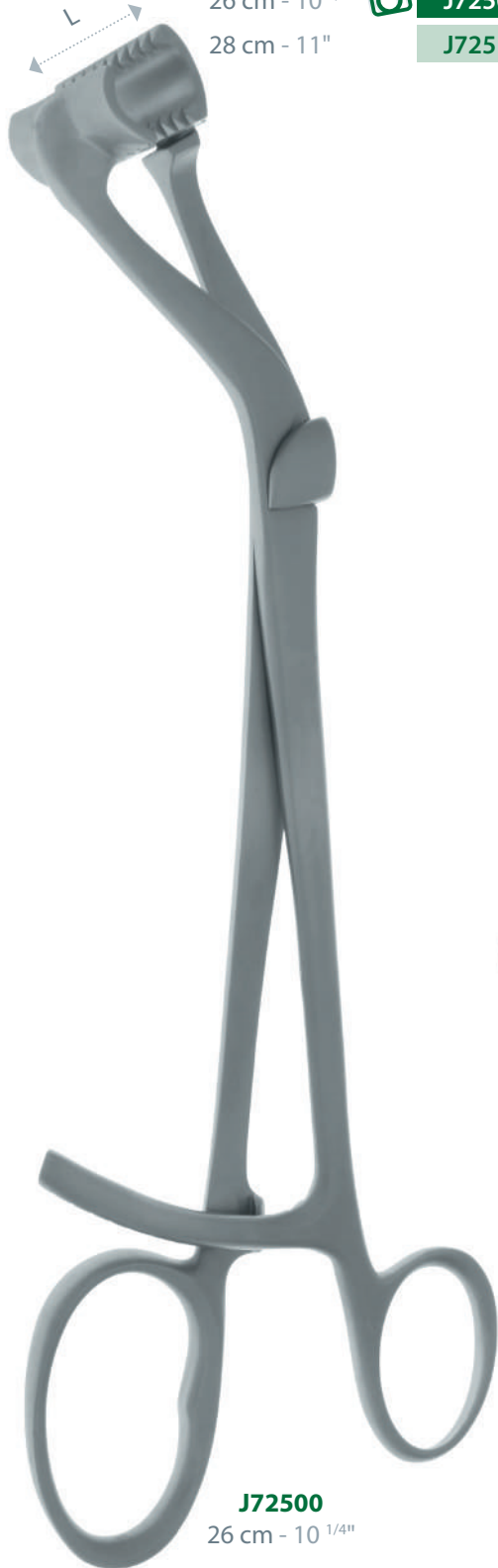

ULRICH

Droit
Straight
Recta

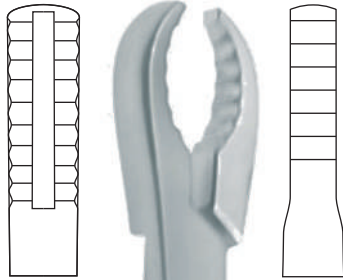

J725212
25 cm - 10"

Courbe
Curved
Curva



J725222
25 cm - 10"

J725211	23 cm - 9"	J725221	
J725212	25 cm - 10"	J725222	
J725213	28 cm - 11"	J725223	

Daviers - Bone holding forceps - Pinzas para huesos

Auto-centreur avec système d'arrêt fileté
 Auto-centering with threaded blocking system
 Auto-centrador con sistema de bloqueo roscado

15 cm - 6"	J725200
19 cm - 7 1/2"	J725201
24 cm - 9 1/2"	J725202 
26 cm - 10 1/4"	J725203
28 cm - 11"	J725204



J725200



J725201

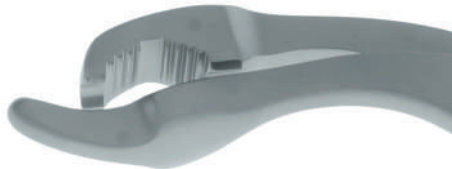

J725202



J725202
 24 cm - 9 1/2"

FARABEUF



J72020

17 cm - 6 ³/₄"

J72030



J72040

19 cm - 7 ¹/₂"

J72050



J72060

26 cm - 10 ¹/₄"

J72070

J72040

19 cm - 7 ¹/₂"

Sans crémaillère
Without ratchet
Sin cremallera

A crémaillère
With ratchet
Con cremallera

J72050

19 cm - 7 ¹/₂"



LAMBOTTE

22 cm - 8³/₄" **J72230** 

26 cm - 10¹/₄" **J72240**

35 cm - 13³/₄" **J72250**

22 cm - 8³/₄" **J72260** 

26 cm - 10¹/₄" **J72270**

33 cm - 13" **J72280**

22 cm - 8³/₄" **J72200** 

26 cm - 10¹/₄" **J72210**

33 cm - 13" **J72220**



J72230
22 cm - 8³/₄"



J72260
22 cm - 8³/₄"

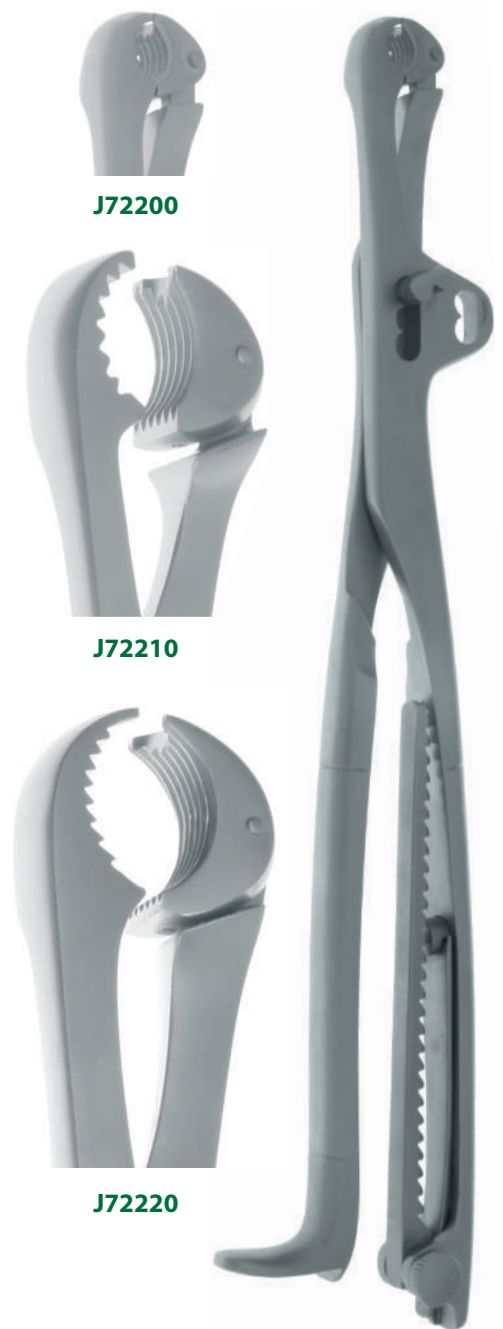

J72200

J72210

J72220

J72200
22 cm - 8³/₄"

Daviers - Bone holding forceps - Pinzas para huesos

LANE (KERN)

Sans crémaillère
Without ratchet
Sin cremallera

21 cm - 8 1/4" **J72310**

34 cm - 13 1/2" **J72330**

À crémaillère
With ratchet
Con cremallera

21 cm - 8 1/4" **J72320** 

34 cm - 13 1/2" **J72340**



J72320
21 cm - 8 1/4"

KERN



J72540
16,5 cm - 6 1/2"

OLLIER

- 16 cm - 6 1/4" **J72120**
- 18 cm - 7" **J72130** 
- 22 cm - 8 3/4" **J72140**

- 19 cm - 7 1/2" **J72150** 
- 22 cm - 8 3/4" **J72160**
- 27 cm - 10 3/4" **J72170**

Pour os mous
For soft bones
Para huesos blandos

Pour rotule
For the kneecap
Para rotula



Sans crémaillère
Without ratchet
Sin cremallera

J72130
18 cm - 7"



À crémaillère
With ratchet
Con cremallera

J72150
19 cm - 7 1/2"



J72160



J72170

Daviers - Bone holding forceps - Pinzas para huesos

SETTER

17 cm - 6 3/4"

J725860



24 cm - 9 1/2"

J725870



J725860

J725870

J725860
17 cm - 6 3/4"

HEY GROVES

20 cm - 8"

J725880



25 cm - 10"

J725885

30,5 cm - 12"

J725890



J725885

J725890

J725880
20 cm - 8"

Daviers - Bone holding forceps - Pinzas para huesos

SEMB

9 mm



J72180
22 cm - 8 3/4"

8 mm



J721810
19 cm - 7 1/2"

7,5 mm



J721820
19 cm - 7 1/2"

Coudé latéral
Angular laterally
Acodado lateral

LANGENBECK

FERGUSON

DENTS DE LION
LION'S TEETH
DIENTES DE LEÓN

11 mm

11 mm

8 mm



J72100
19 cm - 7 1/2"



J721010
21 cm - 8 1/4"



J721020
21 cm - 8 1/4"



OLLIER

POUR RÉSECTION
FOR RESECTION
PARA RESECCIÓN

PINCES À SEQUESTRE
SEQUESTER FORCEPS
PINZAS PARA SEQUESTRO



J72090
23 cm - 9"



J72110
19 cm - 7 1/2"



J72550
21 cm - 8 1/4"

Droite
Straight
Recta

Courbe
Curved
Curva



J72560

Double courbure
Double curved
Doble curvatura



J72570

LOWMAN-HOGLUND



J727500
19 cm - 7 1/2"

LOWMAN

- 12 cm - 4 3/4" **J727550**
- 18 cm - 7" **J727560**
- 20 cm - 8" **J727570** 
- 22 cm - 8 3/4" **J727580**



J727570
20 cm - 8"

Système de distraction
Distractor system
Sistema de distracción

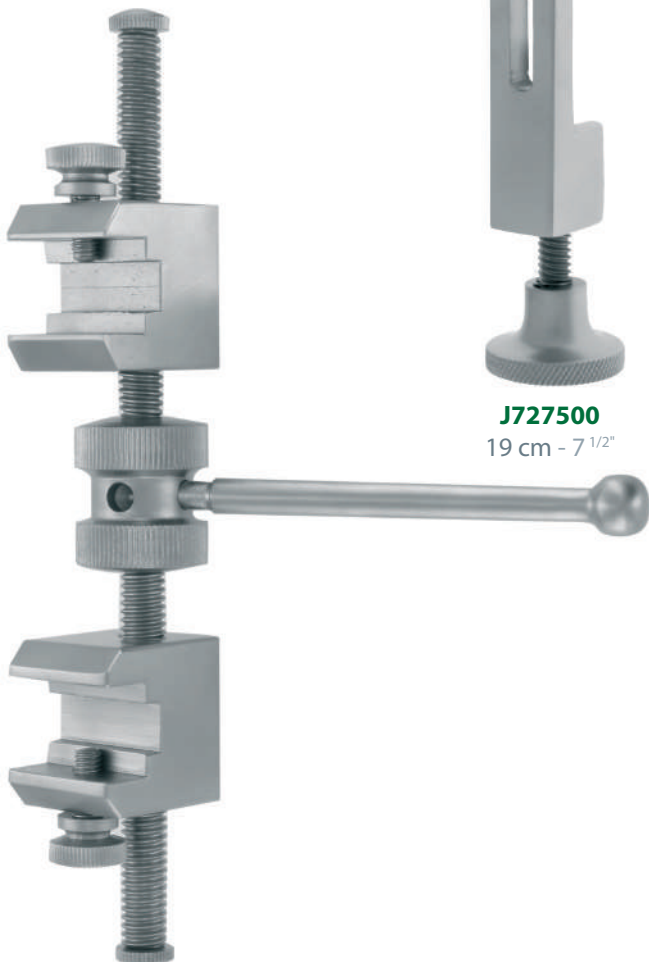

J727590
15,5 cm - 6"

Daviers - Bone holding forceps - Pinzas para huesos

LERAT

PINCES À CAPSULE
CAPSULE FORCEPS
PINZAS PARA CAPSULA

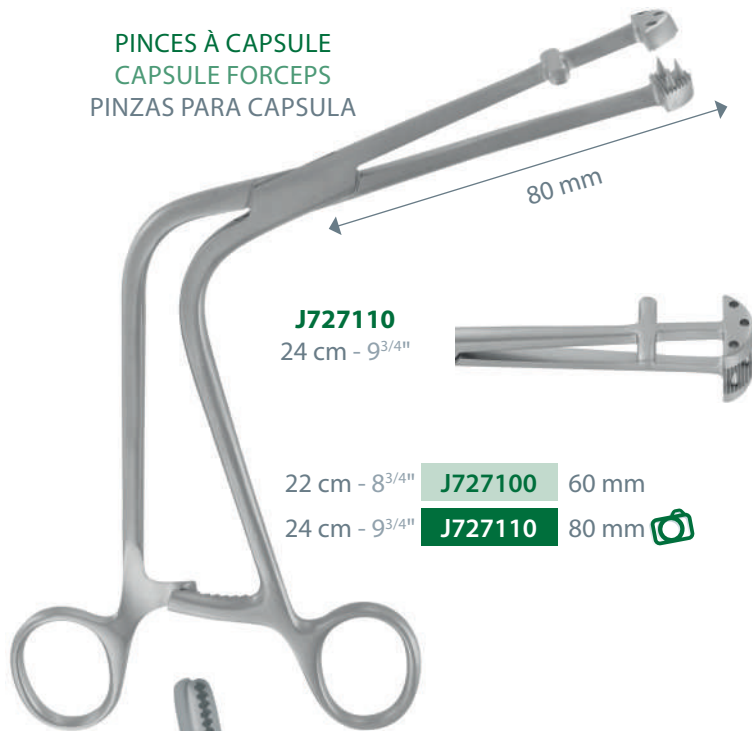

J727110
24 cm - 9³/₄"

22 cm - 8³/₄" **J727100** 60 mm

24 cm - 9³/₄" **J727110** 80 mm

MUSEUX



J72195
24 cm - 9¹/₂"



J72705
21 cm - 8¹/₄"

LEWIN



J727120
17,5 cm - 7"

Écarteur, mains de plomb - Retractor, lead hands - Separador, manos de plomo

Grande valve seule
Large blade only
Valvula grande sóla

J732010
25 x 40 mm



Petite valve seule
Small blade only
Valvula pequena sóla

J732005
25 x 50 mm



CHARNLEY

Poids seul avec chaîne
Weight only with chain
Peso sólo con cadena

J732020

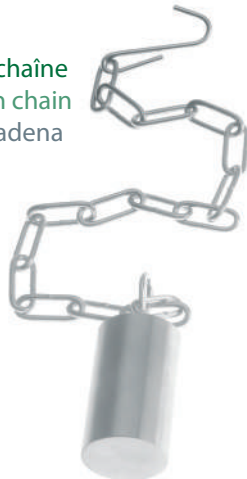

CADRE COMPLET AVEC 2 VALVES ET 1 POIDS
COMPLETE FRAME WITH 2 BLADES AND 1 WEIGHT
CUADRO COMPLETO CON 2 VALVAS Y 1 PESO

J732000

24 x 30 cm
9 1/2" x 11 3/4"

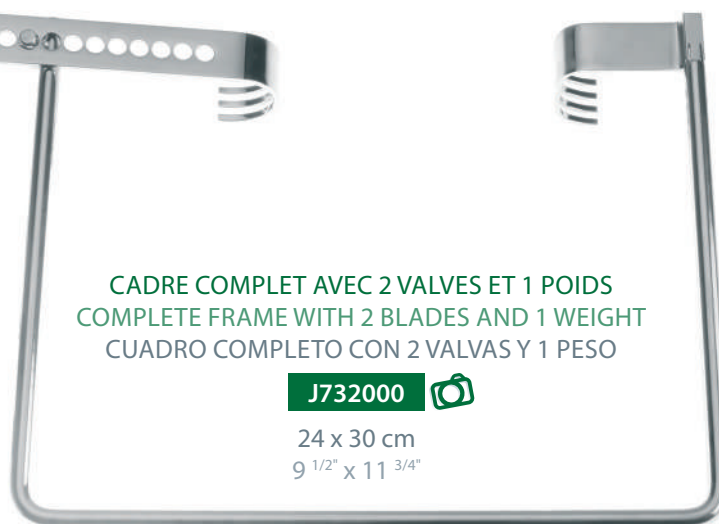

MAIN DE PLOMB ADULTE
ADULT LEAD HANDS
MANOS DE PLOMO ADULTO



J733000
33 cm - 13"

MAIN MALLÉABLE SILICONÉE
MALLEABLE HAND SILICONE
MANOS MALLEABLE SILICONA



J733050
33 cm - 13"

Non lestée
No weighted
Sin ponderada

J733050

Lestée
Weighted
Ponderada





J733060

Patented
Modèle déposé
Patentado

TRILLAT

DEMOISELLE

PASSOW

9 x 9 mm	J804510	6 x 13 mm	J80460 	5 x 8 mm	J804850 	2,5 x 2,5 mm	J804880 
9 x 16 mm	J804520 	10 x 15 mm	J80470	8 x 12 mm	J804860	3,5 x 3,5 mm	J804885
9 x 19 mm	J804530	11 x 20 mm	J80480	12 x 20 mm	J804870		



J804520
20 cm - 8"

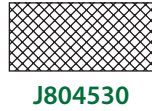
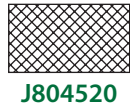

J80460
18 cm - 7"

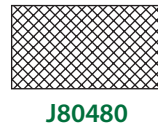
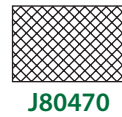
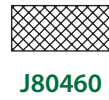

J804850
18 cm - 7"

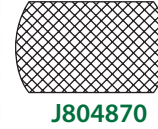

J804880
12 cm - 5"



LANDANGER

Chasse-greffons - Grafts pusher - Empujador de injertos

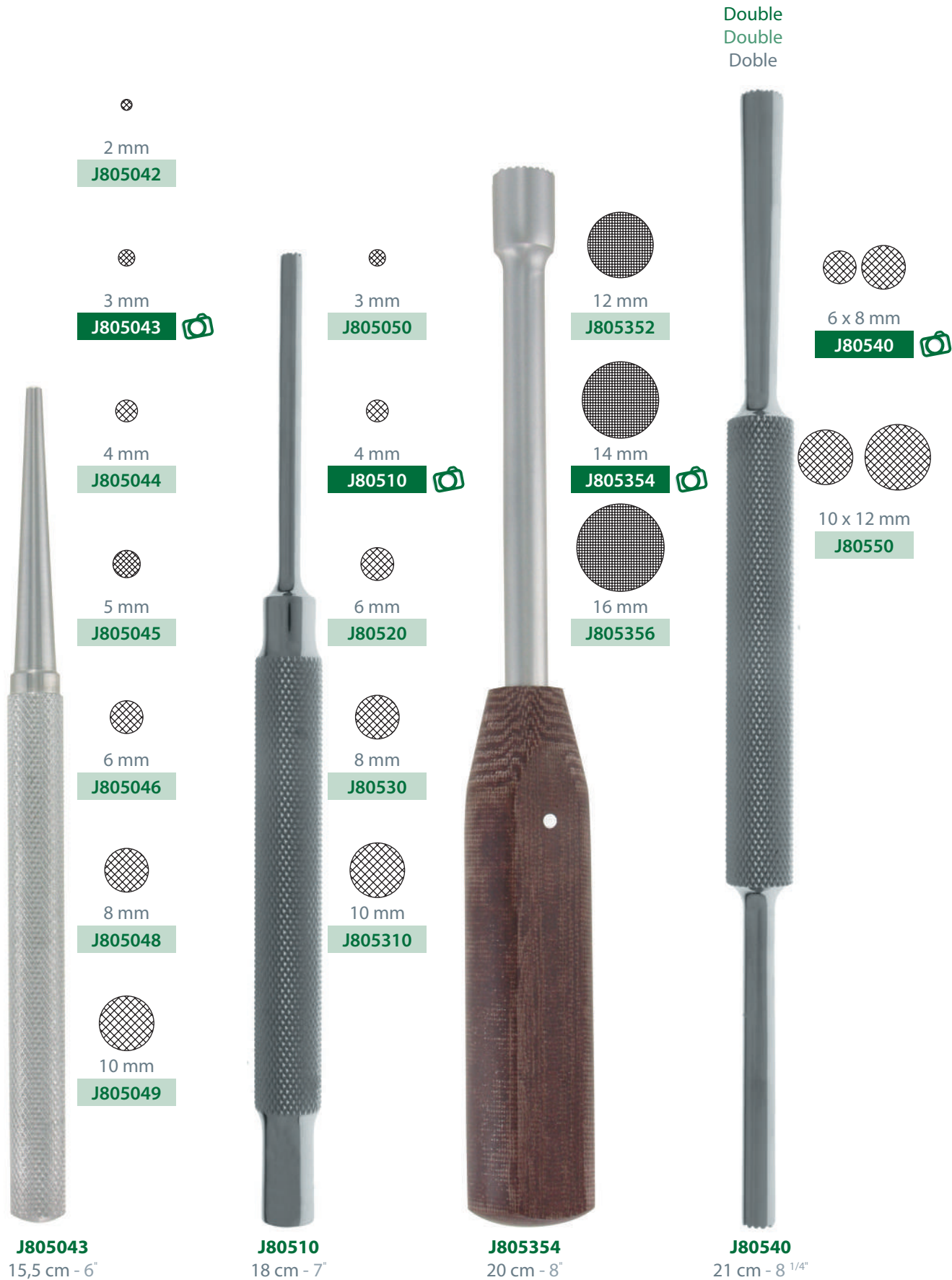

XIII - Osseux
XIII - Bone surgery
XIII - Cirugía ósea

KÖLBEL



Complet avec 3 paires de valves laterales
 Complete with 3 pair of lateral blades
 Completo con 3 pares de valvas laterales

Valves latérales (la paire)
 Latéral blades (pair)
 Valvas laterales (par)

J821000

Longueur x Largeur
 Length x Wide
 Largo x Amplia



J821012	36 x 18 mm
J821013	53 x 18 mm
J821014	68 x 18 mm
J821019	20 x 36 mm
 J821020	36 x 36 mm
 J821030	53 x 36 mm
 J821040	68 x 36 mm
J821041	20 x 53 mm
J821042	20 x 68 mm
J821043	20 x 85 mm
J821044	36 x 85 mm

Compas seul
 Compass only
 Compas sólo

J821010
 20 cm - 8"

**MERLE D'AUBIGNÉ
(BANKART)**

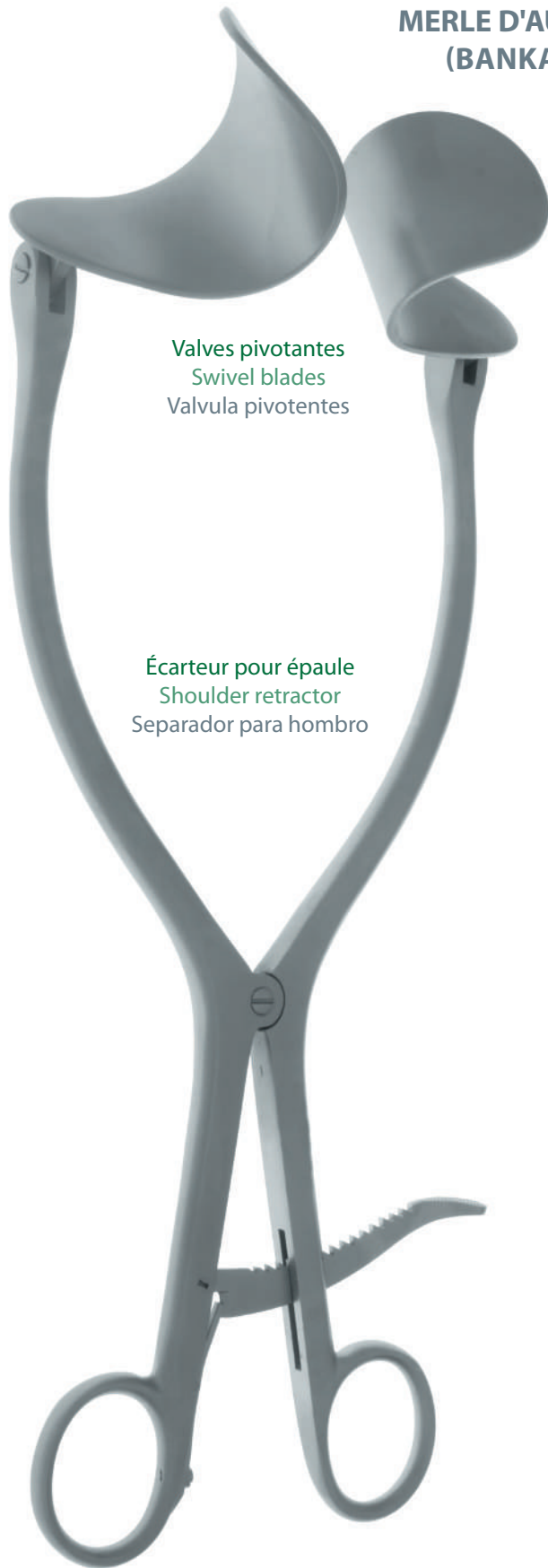

Valves pivotantes
Swivel blades
Valvula pivotentes

Écarteur pour épaule
Shoulder retractor
Separador para hombro

J82010
29 cm - 11 1/2"

Passe fil avec aiguille
Wire guide with needle
Pasa hilo con aguja



J82020
24 cm - 9 1/2"

POZZI

MERLE D'AUBIGNÉ

BANKART



J82030
24 cm - 9 1/2"



J82040
23 cm - 9"

18 mm



J82050
21 cm - 8 1/4"

DANIS

TRILLAT

Écarteur
Retractor
Separador

Spatule
Spatula
Espátula

Levier pour épaule
Lever for shoulder
Elevador para hombro

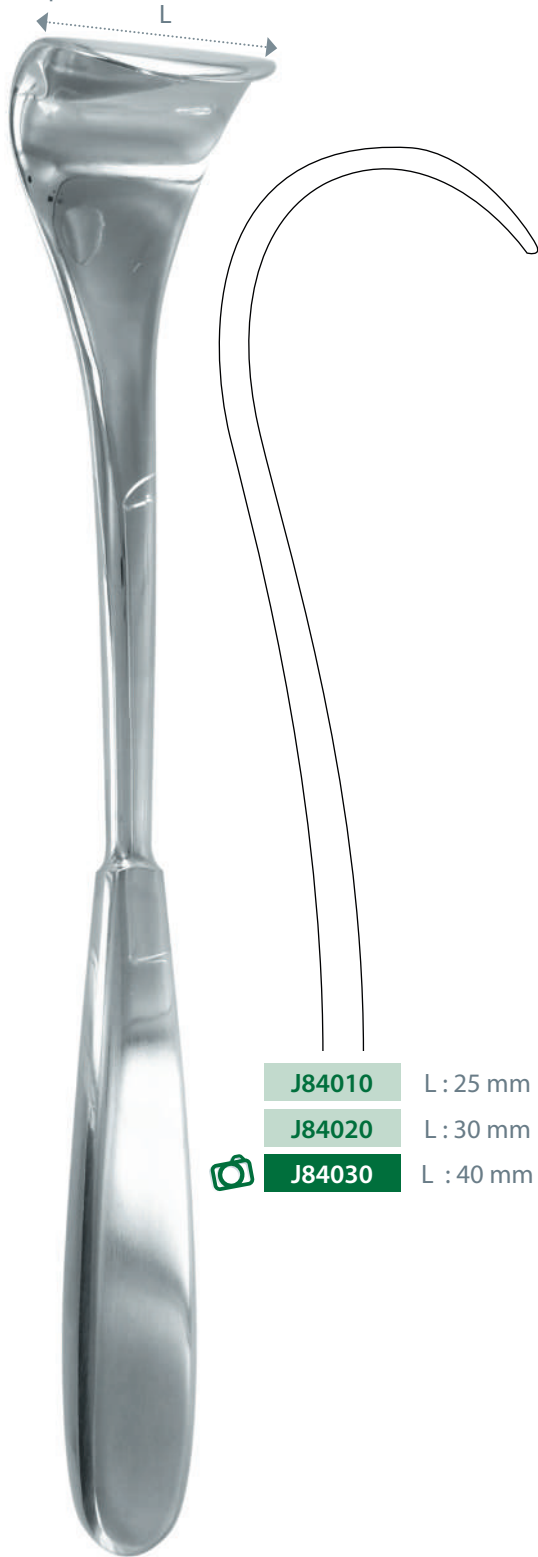

J84010 L : 25 mm

J84020 L : 30 mm

 J84030 L : 40 mm

J84030
23 cm - 9"



J84040
24 cm - 9 1/2"



J80210
24 cm - 9 1/2"

DANIS

Refouloir
Tamping tool
Recalcador

Ø 12 mm



J84070

17,5 cm - 6 3/4"

Passe fil - Wire guide - Pasa hilo

Ø 72 mm



J84130

21 cm - 8 1/4"

Ø 50 mm



J84120

19 cm - 7 1/2"

Ø 32 mm



J84110

17,5 cm - 6 3/4"

SMILLIE-TRILLAT

Tranchant - Sharp - Cortante

8 mm
Droit
Straight
Recto



J80010
17 cm - 6 3/4"

Courbe
Curved
Curvo



J80015

Gauche
Left
Izquierda

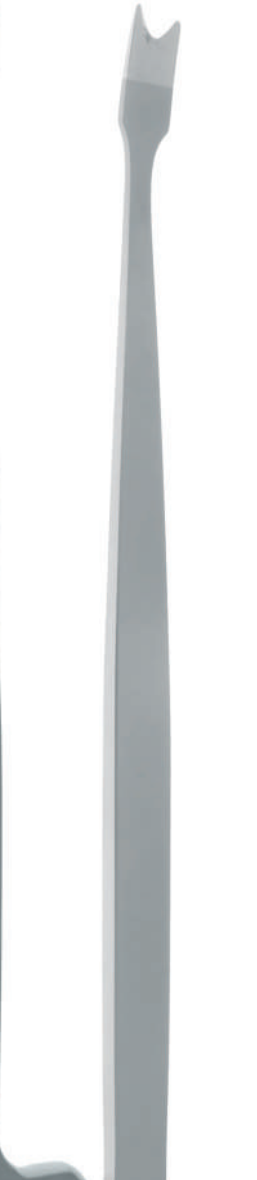

J80020

Droite
Right
Derecha



J80030

NEFF

Gauche
Left
Izquierda



J800400

Droite
Right
Derecha



J800405

J800400
21,5 cm - 8 1/2"

BIRCHER



J800500
19 cm - 7 1/2"

SMILLIE-TRILLAT

BLOUNT

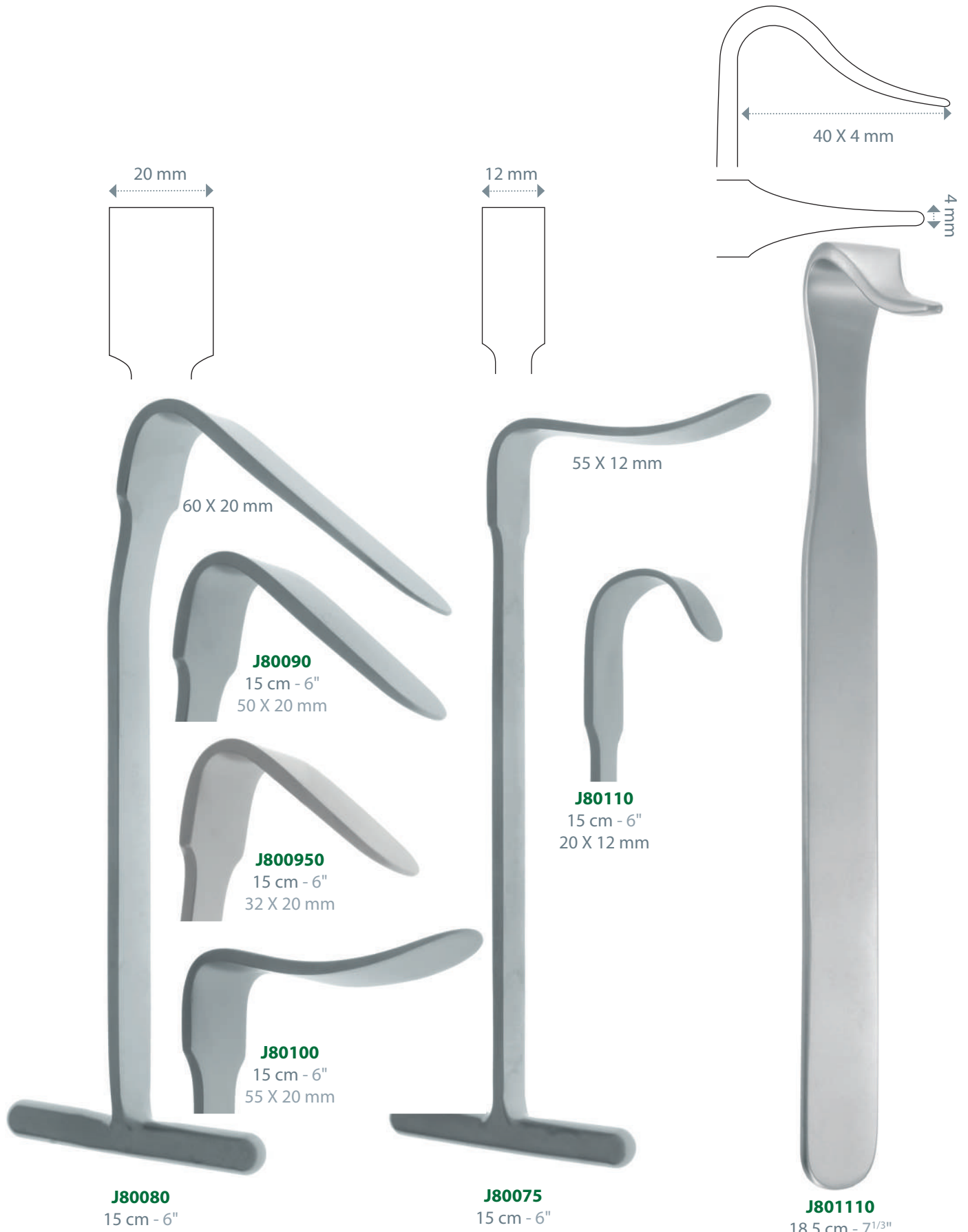

NICOLLET-MUSEUX



J80130
16 cm - 6 1/4"

LANDANGER



J80120
19 cm - 7 1/2"

NICOLLET-KOCHER



J80140
16 cm - 6 1/4"

BIRCHER-GANSKE

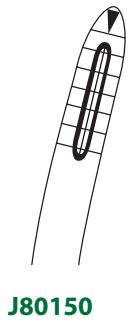

J80150

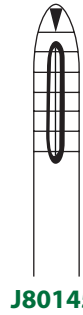

J801450

Courbe latérale
Ccrved lateraly
Curva lateral



J80150
20 cm - 8"



J801550
20 cm - 8"

TRILLAT

Triangulaire
Triangular
Triangular

Ø 8 mm



J80370
26 cm - 10 ¹/₄"

Crochet
Hook
Ganchura



J80390
24 cm - 9 ¹/₂"

Explorateur
Hook probe
Explorador



J80420
24 cm - 9 ¹/₂"

Ø 2,5 mm

Passe-fil
Wire guide
Guia hilo



J80200
30 cm - 11 ³/₄"

TRILLAT

- 6 mm **J80270** 
- 8 mm **J80280**
- 10 mm **J80290**
- 12 mm **J80300**
- 14 mm **J80305**



Rugine
Raspatories
Raspadores

J80270
22 cm - 8 3/4"

MURPHY

17 mm

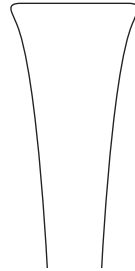

Gouge
Gouge
Gubia



Droite
Straight
Recta

- 22 cm - 8 3/4" **J80435**
- 28 cm - 11" **J80430**

Concave
Concave
Concavo

- 22 cm - 8 3/4" **J80445** 
- 28 cm - 11" **J80440**

Convexe
Convex
Convexo

- 22 cm - 8 3/4" **J80455**
- 28 cm - 11" **J80450**

LEMAIRE

Rifloir
Rasp
Lima



J80500
20 cm - 8"

OLLIER

18 cm - 7" **J80220** 

20 cm - 8" **J80230**

Aiguille pour rotule
Needle for kneecap
Aguja para rotula

Poinçon
Point
Punzón



J80220
18 cm - 7"



J80495
19 cm - 7 1/2"



J804970
23 cm - 9"



J804960
14 cm - 5 1/2"

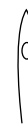

KIRSCHNER



- A
- 115 mm J90030
 - 135 mm J90040 
 - 145 mm J90050

J90040

Clé seule
Wrench only
Llave sólo

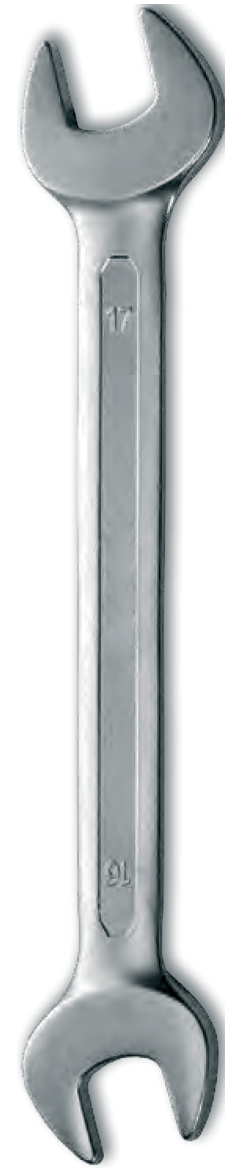

17 mm

16 mm

J901010
20,5 cm - 8"

Crochet seul
Hook only
Ganchura sólo



J90080

Tendeur
Tensioner
Tensor

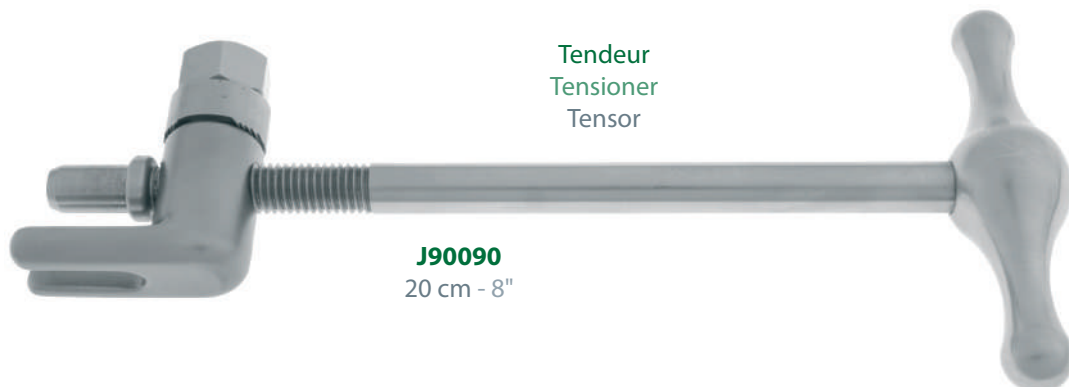

J90090
20 cm - 8"

KIRSCHNER

Extension réglable - Adjustable traction bow - Extensión regulable

40 - 140 mm	J90060	
60 - 220 mm	J90070	



Clé seule
Wrench only
Llave sóla

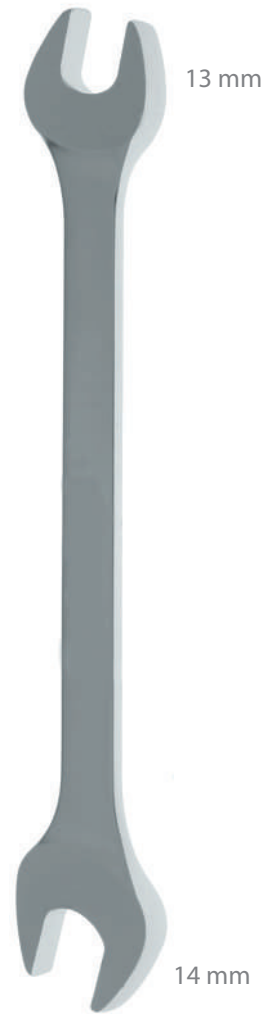

J90065
18 cm - 7"

KIRSCHNER (AMERICAN)

Extensible - Avec 2 crochets - Adjustable - With 2 hooks - Extensible - Con 2 ganchuras

55 - 120 mm **J90110**

65 - 130 mm **J90120** 

90 - 200 mm **J90130**

90 - 250 mm **J90140**



Crochets seuls (paire)
Hooks only (pair)
Ganchuras sólo (par)



J90150

J90120
65 - 130 mm

BOEHLER

A	B	
90 mm	100 mm	J90220 
120 mm	110 mm	J90230
115 mm	150 mm	J90240

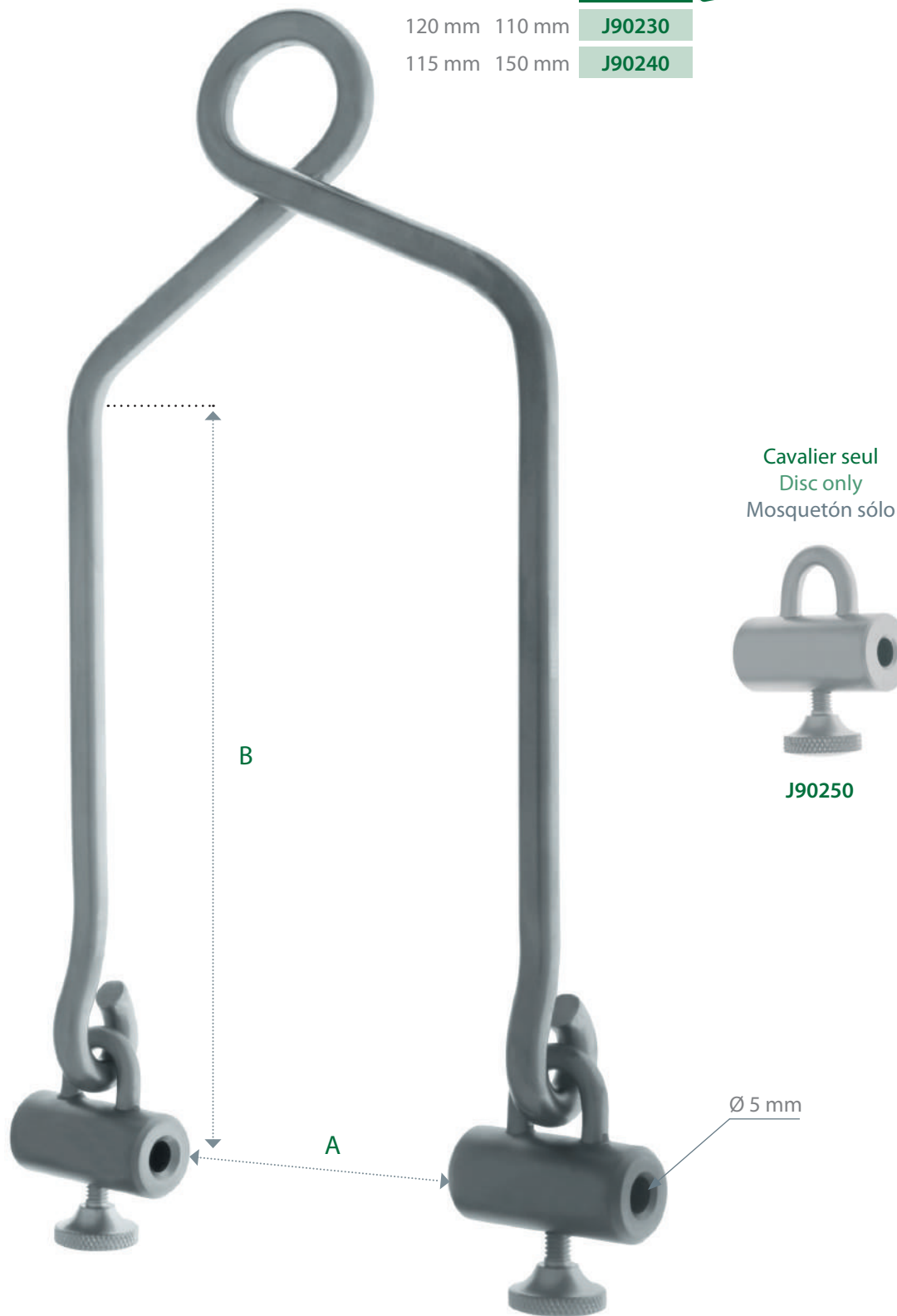

Cavalier seul
Disc only
Mosquetón sólo



J90250

J90220

90 - 100 mm

Ø 5 mm



Filet métallique pour la traction des doigts
Wire mesh for traction of fingers
Malla de alambre para tracción de los dedos

Pince pour extraction du ciment
Cement extraction forceps
Pinza de extracción de cemento

Petit
Small
Pequeño

154 mm

J904000



Moyen
Medium
Medio

170 mm

J904010

Grand
Large
Grande

183 mm

J904020



J904000
15,4 cm - 6"



J780000
38 cm - 15"



Forets - Drills - Brocas Tarauds - Taps - Terrajas Mandrins - Chucks - Mandriles

Mandrins universels - Universal chucks - Mandriles universales



Perforateurs manuels - Bone hand drills - Perforadores manuales

Fraises et jauges - Reamers and gauges - Fresas y medidores

Tournevis - Screw driver - Destornilladores



Tournevis - Screw driver - Destornilladores

Guide mèches - Drills guide - Guías de brocas

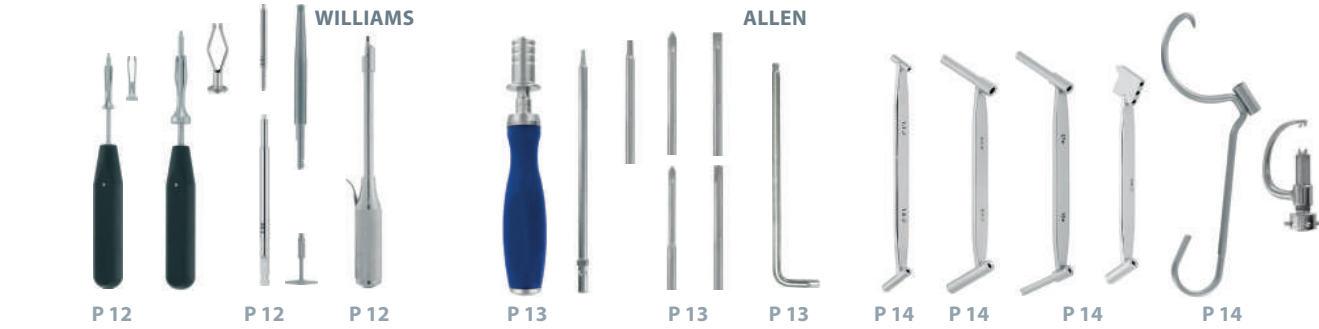

Guide mèches - Drills guide - Guías de brocas

Instrumentation pour plaques - Instruments for plates - Instrumentación para placas



Instrumentation pour plaques - Instruments for plates - Instrumentación para placas

Instrumentation de cambrage - Instruments for bending - Instrumentación para doblar

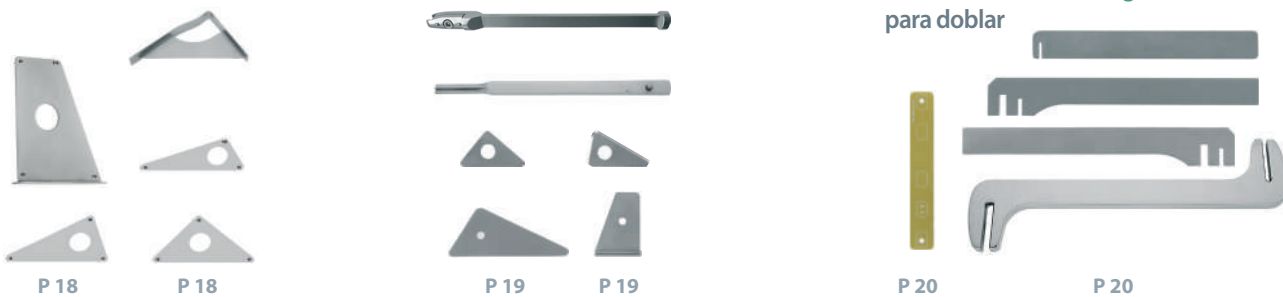

Instrumentation de cambrage - Instruments for bending - Instrumentación para doblar



Instrumentation pour plaques - Instruments for plates - Instrumentación para placas



Ciseau à os - Osseous chisel - Cincel para huesos



Pinces spécifiques - Specific forceps - Pinzas específicas



Pinces multiservices - Multiservices forceps - Pinzas multiservicios



Pinces à fils métalliques - Wire pliers - Pinzas de alambre

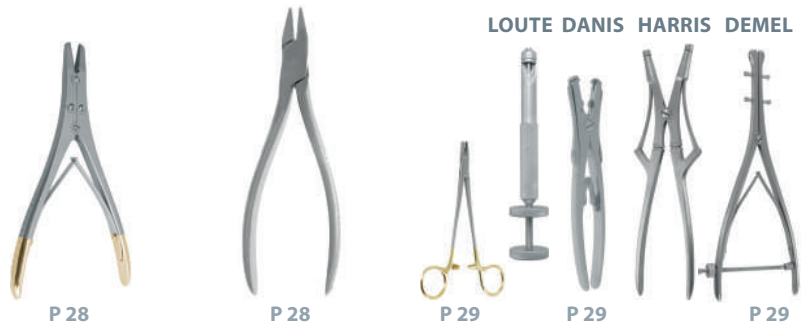

Pinces à couper les fils - Wire cutting pliers - Alicates para cortar alambre

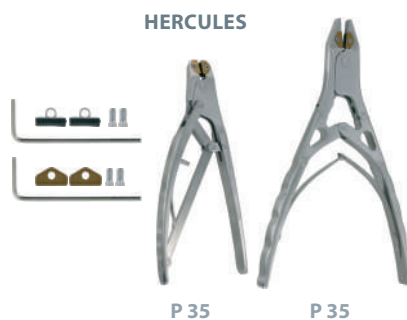

**Tréphines et perforateurs - Trephine and drills -
Trephine y perforadores**

MICHELE NELATON LUCAS-CHAMPIONNIERE



P 37 P 37 P 37

**Protecteur de peau - Skin protector -
Protector de piel**



P 38

**Guide pour alésoirs et clous IM - Guide for reamers
and nails IM - Guía para brocas y clavos IM**

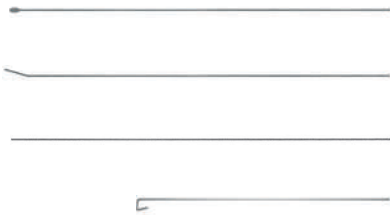

P 39

**Instrumentation pour enclouage IM - Instruments for
IM nails - Instrumentación para clavos IM**



P 40 P 40 P 40 P 40

**Instrumentation pour enclouage IM - Instruments for
IM nails - Instrumentación para clavos IM**



P 41 P 41 P 41 P 41

**Instrumentation pour clou RUSH - Instruments for RUSH
nails - Instrumentación para clavos RUSH**



P 42 P 42 P 42

Instrumentation pour clous élastiques - Instrument for flexible nails - Instrumentación para clavos flexibles



P 43 P 43 P 43 P 43

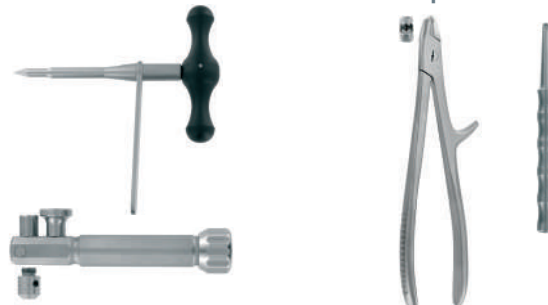

P 44 P 45

Instrumentation pour enclouage - Instruments for nails - Instrumentación para clavos

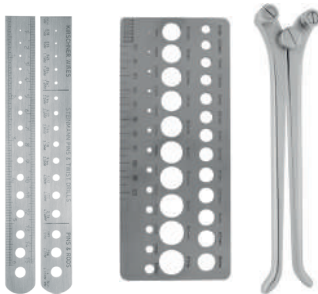

P 46 P 46 P 46

Instrumentation pour vis perforées - Instruments for cannulated screw - Instrumentación para tornillos canulados



Instrumentation pour agrafes - Instruments for staples - Instrumentación para grapas



Instrumentation pour cerclage - Instruments for cerclage - Instrumentación para cerclage





Embase cylindrique - Cylindric neck sleeve - Apoyo cilíndrico

Ø mm	L : mm	
1,0	55	M004510
1,5	70	M004511
2,0	85	M004512
2,5	95	M004513
2,7	100	M004514
3,2	130	M004515
3,5	112	M004516
4,5	130	M004517



M004513
95 mm - 3^{3/4}"

Verrouillage rapide AO - Quick locking system AO - Bloqueo rápido AO

Ø mm	L : mm	
1,1	60	M004530
1,5	85	M004531
2,0	100	M004532
2,0	125	M004533
2,5	110	M004534
2,7	100	M004535
2,7	125	M004536
3,2	145	M004537
3,2	195	M004538
3,5	110	M004539
3,5	145	M004540
3,5	195	M004541
4,5	145	M004542
4,5	195	M004543



AO

M004534
110 mm - 4^{1/3}"

Tarauds - Taps - Terrajas

Poignée en T
T handle
Mango T

Ø 2,7 mm	M00460	Pitch 1,25
Ø 3,5 mm	M00461	Pitch 1,25
Ø 3,5 mm 	M00462	Pitch 1,75
Ø 4,0 mm	M004625	Pitch 1,75
Ø 4,5 mm long	M00463	Pitch 1,75
Ø 6,5 mm	M00464	Pitch 2,75



M00462
Ø 3,5 mm
16 cm - 6 1/4"

Ø 1 - 1,5 mm



M01112

AO

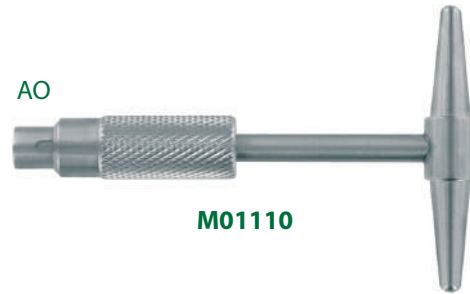

M01110

AO



M01111

Jacobs

Ø : 0 à 4 mm

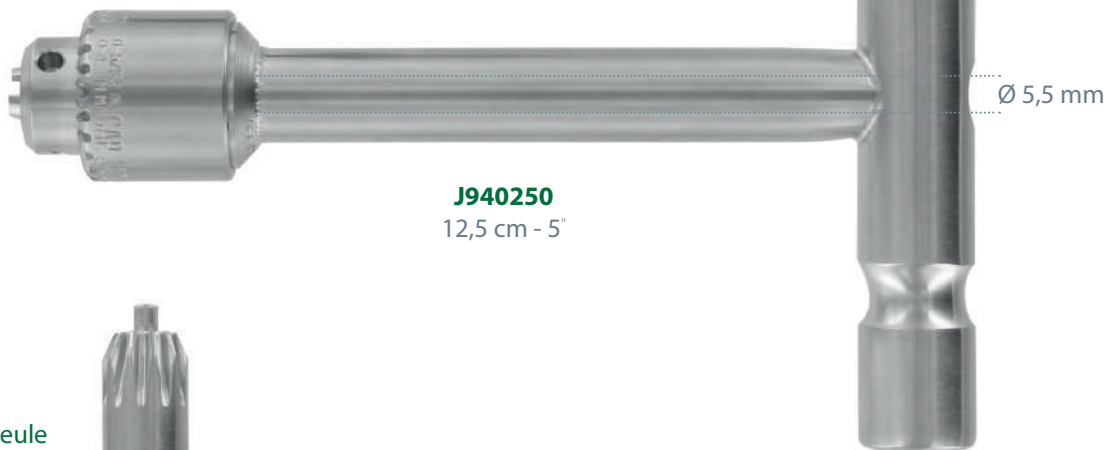

J940250
12,5 cm - 5"

Clé seule
Key only
Llave sola



J94210

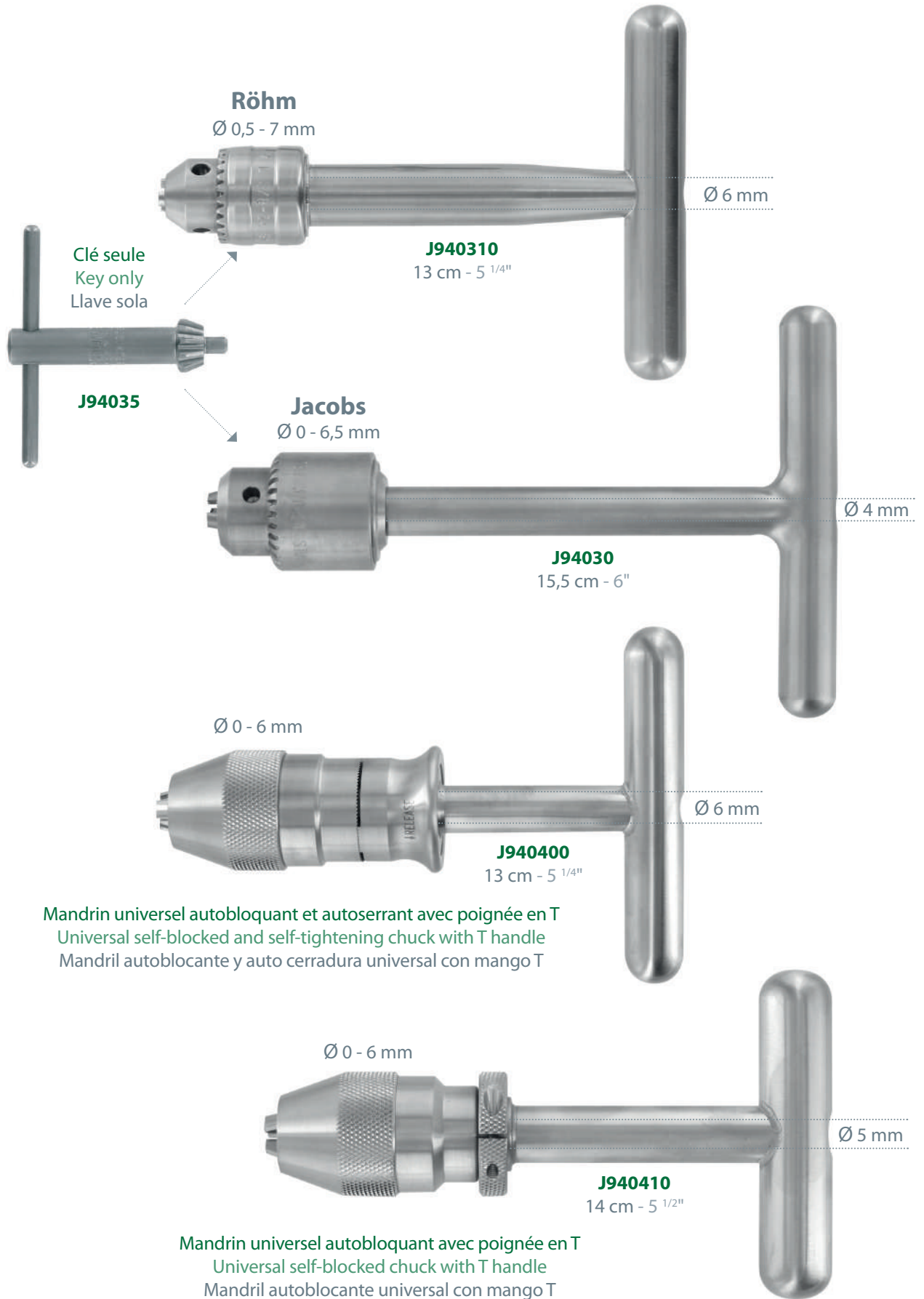

RALK

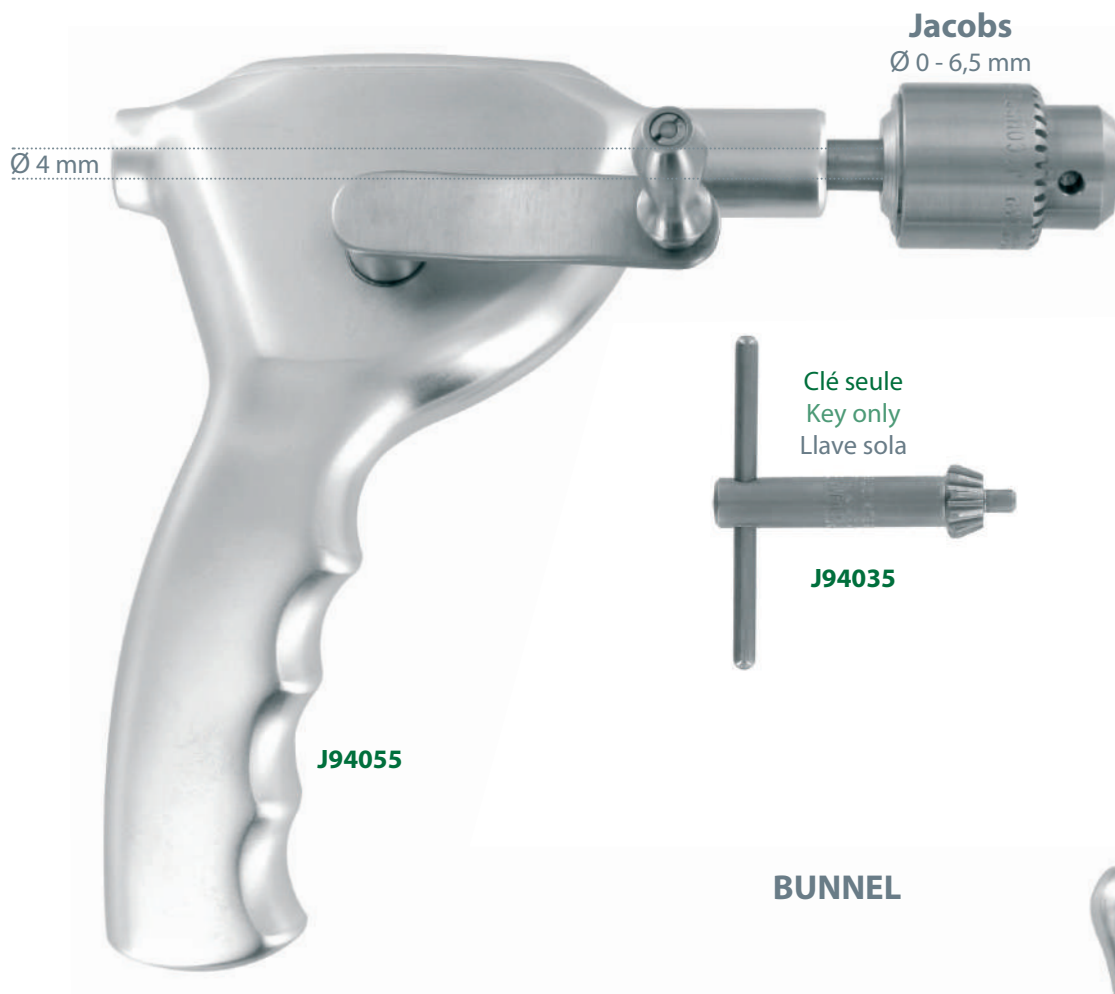

BUNNEL

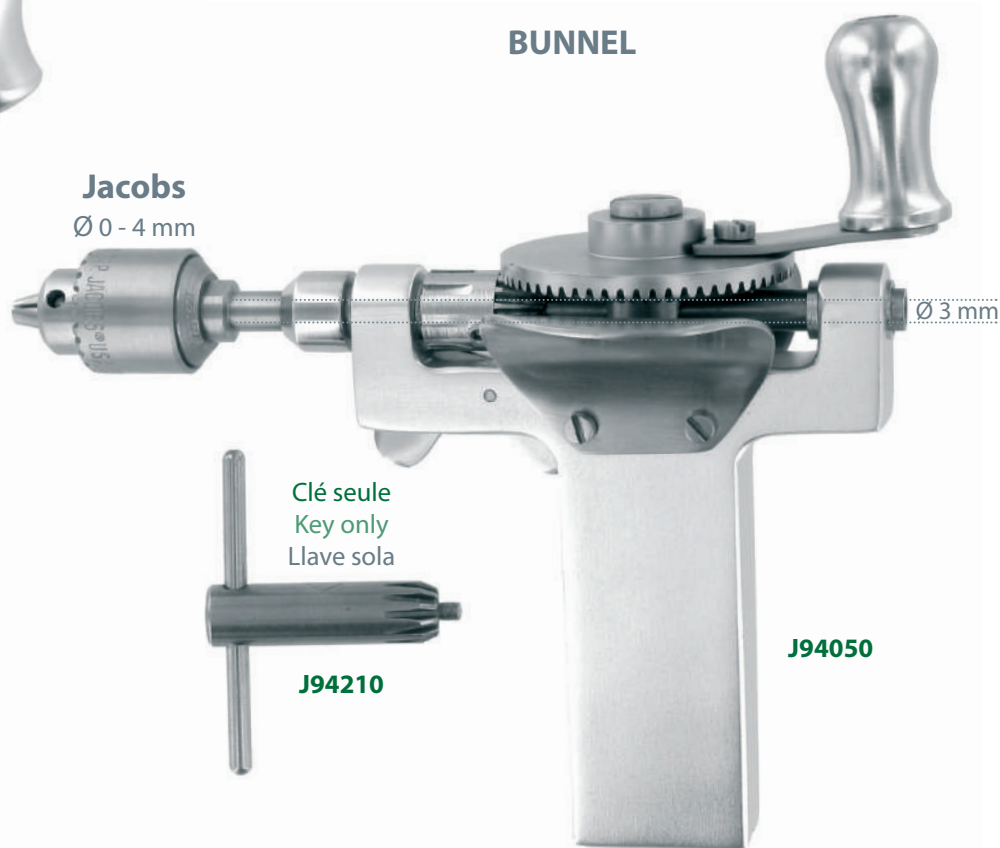

Pour mini vis Ø 1,5 - 2,0 mm
 For mini screw Ø 1,5 - 2,0 mm
 Para mini tornillos Ø 1,5 - 2,0 mm



M00490

Pour vis Ø 4,5 - 6,5 mm
 For screw Ø 4,5 - 6,5 mm
 Para tornillos Ø 4,5 - 6,5 mm

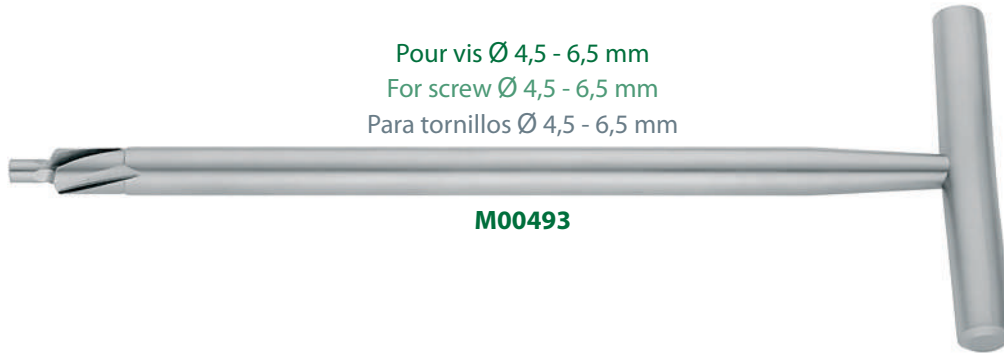

M00493



Pour vis
 For screw
 Para tornillos

M03024

Ø 1,5 - 2,0 mm

M03020

Ø 2,7 - 3,5 - 4,0 mm

M03022

Ø 4,5 - 6,5 mm

M03024



Tournevis - Screw driver - Destornillador



Tournevis pour vis à tête hexagonale
Screw driver for hexagonal head
Destornillador para tornillos con cabeza hexagonal



Pour vis - For screw - Para tornillos

18 cm - 7" 1,5 mm  **M01120** Ø 1,5 - 2,0 mm



M01122

24 cm - 9 1/2"

Pour vis - For screw - Para tornillos

24 cm - 9 1/2" 2,5 mm  **M01122** Ø 2,7 - 3,5 - 4,0 mm

24 cm - 9 1/2" 3,5 mm **M01124** Ø 4,5 - 6,5 mm



Tournevis de Philips
Screw driver for Philips head
Destornillador para cabeza Philips



M01126

20 cm - 8"



Tournevis pour vis à tête fendue
Screw driver for single head
Destornillador para cabeza simple



M01128

20 cm - 8"



Tournevis pour vis tête en croix
Screw driver for slotted head
Destornillador para cabeza cruz



M01130

20 cm - 8"

Crochet pour tête de vis
Hook for screw head
Gancho para cabeza de tornillos



M02200

Tournevis - Screw driver - Destornillador



Tournevis avec préhenseur pour vis à tête hexagonale
Screw driver with holding sleeve for hexagonal head
Destornillador cone pinza de sujeción para tornillos con cabeza hexagonal



Préhenseur seul 1,5 mm
Holding sleeve only 1,5mm
Pinza de sujeción sólo 1,5 mm

M01140
1,5 mm
18 cm - 7"

Pour vis
For screw
Para tornillos
Ø 1,5 - 2,0 mm



M01150



Préhenseur seul 2,5 mm
Holding sleeve only 2,5 mm
Pinza de sujeción sólo 2,5 mm

M01160
2,5 mm
20 cm - 8"

Pour vis
For screw
Para tornillos
Ø 2,7 - 3,5 - 4,0 mm



M01170

Pince autoserrante - Porte vis
Self holding forceps - Screw holder
Pinza autofijadora - Porta tornillos



M03060
8 cm - 3"

Embout avec verrouillage rapide - Tip with quick locking system - Punta con bloqueo rápido



1,5 mm

M01175



2,5 mm

M01176

AO



3,5 mm

M01177

AO



Poignée
Handle
Mango

page XIV-3

WILLIAMS



M01132



M01134



M01136



M01138
3,5 mm



M01138
23 cm - 9"

Tournevis - Screw driver - Destornillador

Manche pour tournevis - encliquetage cylindrique
 Handle for screw driver - cylindric locking system
 Mango para destornillador - bloqueo cilindrico



Tournevis 2,5 mm
 Screw driver 2,5 mm
 Destornillador 2,5 mm

M01220
 18 cm - 7"



M01230
 17 cm - 6 3/4"



Tournevis 3,5 mm
 Screw driver 3,5 mm
 Destornillador 3,5 mm



M01235
 17 cm - 6 3/4"



Tournevis Philips
 Screw driver Philips
 Destornillador Philips



M01240
 17 cm - 6 3/4"



Petit tournevis de Philips
 Screw driver Philips head small
 Destornillador Philips pequeño



M01241
 17 cm - 6 3/4"



Tournevis à tête fendue
 Screw driver for single head
 Destornillador cabeza simple



M01200
 17 cm - 6 3/4"



Tournevis à tête en croix
 Screw driver for slotted head
 Destornillador para cabeza cruz



M01210
 17 cm - 6 3/4"

ALLEN

Clés hexagonales
 Hexagonal keys
 Llaves hexagonales

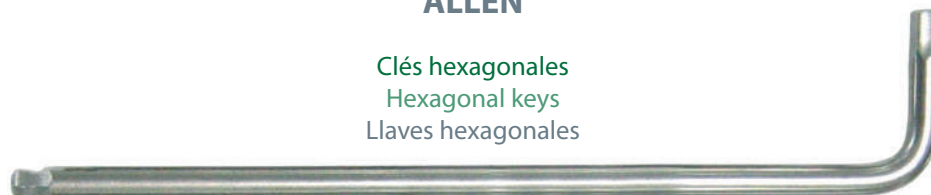

1,5 mm **M012915** 9 cm - 3 1/4"

4,0 mm **M012940** 13,5 cm - 5 1/4"

2,0 mm **M012920** 10 cm - 4"

5,0 mm **M012950** 15,5 cm - 6"

2,5 mm **M012925** 11 cm - 4 1/4"

6,0 mm **M012960** 17 cm - 6 3/4"

3,0 mm **M012930** 12,5 cm - 5"

LANDANGER

Guide mèches - Drills guide - Guías de brocas



Ø 1,1 mm
Ø 1,5 mm

M03380 
M03382

Ø 1,5 mm
Ø 2,0 mm



Ø 2,7 mm
Ø 3,5 mm

M03391
M03390 

Ø 2,0 mm
Ø 2,5 mm



Ø 2,7 mm

M03393

Ø 1,0 mm



Ø 2,0 mm

M03381

Ø 2,0 mm



Guide mèche pointu Ø 6,5 mm
Pointed drill guide Ø 6,5 mm
Guía de brocas agudo Ø 6,5 mm

M03400
16 cm - 6 1/4"

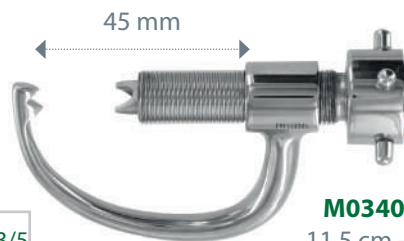

Guide mèche réglable Ø 4,5 mm
Adjustable drill guide Ø 4,5 mm
Guía de brocas ajustable Ø 4,5 mm

M034010
11,5 cm - 4 1/2"



Guide pour taraud
Tap guide
Guía de terraja

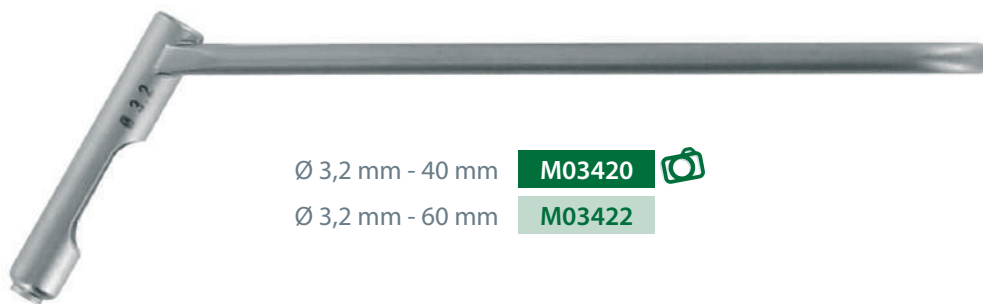

Ø 3,2 mm - 40 mm **M03420**

Ø 3,2 mm - 60 mm **M03422**



M03392
Ø 3,5 mm - 35 mm



M03410
Ø 4,5 mm - 50 mm

Guide mèche pour position neutre et de tension
Neutral and for tension drill guide
Guía de broca neutral y para tensión



Mèche Drill Broca	Vis Screw Tornillo
Ø 1,5 mm	Ø 2,0 mm
Ø 2,0 mm	Ø 2,7 mm
Ø 2,5 mm	Ø 3,5 mm
Ø 3,2 mm	Ø 4,5 mm

M03430

M03431

M03432

M03433

Douille de centrage
Insert drill sleeve
Casquillo dentado



Douille Insert Casquillo	Mèche Drill Broca
Ø 2,7 mm	Ø 2,0 mm
Ø 3,5 mm	Ø 2,5 mm
Ø 4,5 mm	Ø 3,2 mm

M03436

M03437

M03438



Gabarit de forage triple 130° - Ø 3,2 mm
Triple drill guide angle 130° - Ø 3,2 mm
Guía de broca triple 130° - Ø 3,2 mm



M02215

Plaque repère angle ajustable pour
ciseaux conducteurs
Chisel guide with adjustable angle
Controlador de angulo



M02235

Marteau diapason
Slotted hammer
Martillo diapason



M02190

26 cm - 10 1/4"

Impacteur
Impactor
Impactor



M02130

20,5 cm - 8"

Impacteur extracteur
Impactor extractor
Portaplacas y extractor



M02140

Ciseau conducteur pour plaque de hanche profil "U"
Graduated seating chisel "U" shaped
Escoplo - guía graduado perfil "U"



Adultes - Adults - Adultos

M02230

16 mm
25 cm - 10"

Viseur pour plaques condyliennes
 Condylar positioning plate
 Plantilla para placas condileas



M03440

Etalon d'angle
 Positioning plate
 Patron de angulo



M03030



M03031



M03032

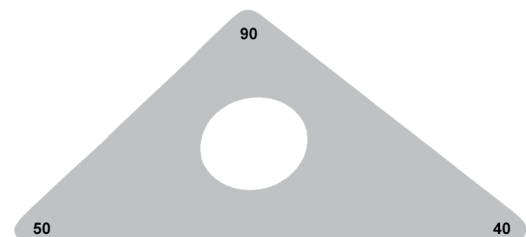

M03033

Impacteur de plaques de hanches pour enfants et adolescents
 Introducer extractor for angled plates - adolescents and children
 Porta placas y extractor para placas anguladas adolescentes y niños



M02150
 26 cm - 10 1/4"

Ciseau conducteur pour plaques coudées en "L"
 Graduated seating chisel for plates "L" shaped
 Escoplo-guía graduado para placas perfil "L"



Adolescents - Teenagers - Adolescentes

M02240
 13 mm
 25 cm - 10"

Enfants - Children - Niños

M02241
 11 mm
 25 cm - 10"

Etalon d'angle
 Positioning plate
 Patron de angulo

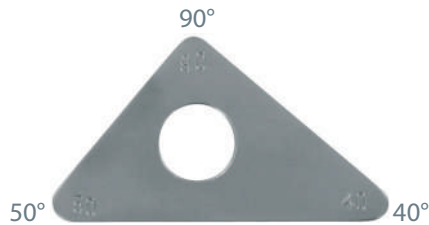

M03034

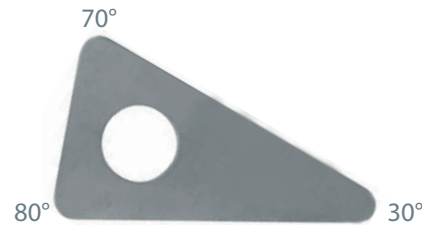

M03035

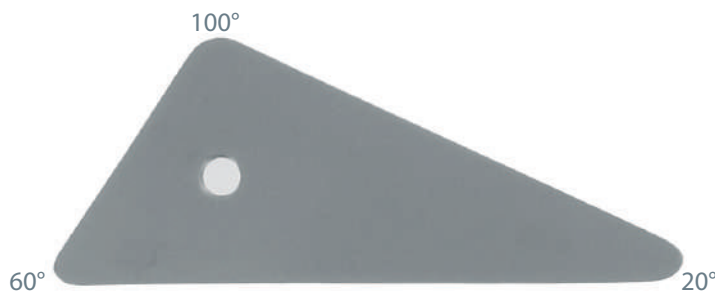

M03036



M03037



Fer à cintrer les mini plaques
 Plate bender for mini plates
 Llave para doblar mini placas



1,8 mm

M01250
 12 cm - 4 3/4"

Fer à cintrer les plaques de reconstruction
 Plate bender for reconstruction plates
 Llave para doblar placas de reconstrucción

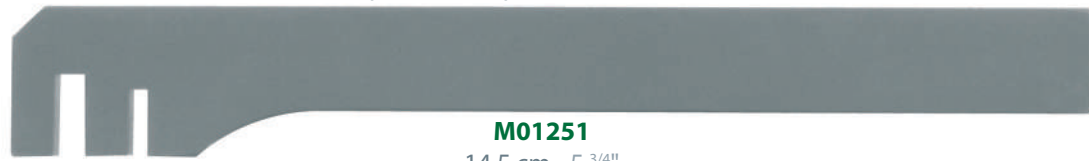

4,0 mm / 2,4 mm

M01251
 14,5 cm - 5 3/4"



M01252
 14,5 cm - 5 3/4"

4 mm / 2,4 mm



5 mm

Fer à cintrer les plaques standards
 Plate bender for standard plates
 Llave para doblar placas rectas

7,3 mm



M01253
 25 cm - 5 1/2"

6,0 mm

Gabarit de cintrage - Template bending - Modelo para doblar



M01050

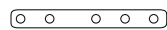

M01051

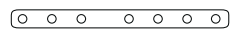

M01052

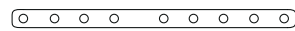

Petite plaque - Small plate - placa pequeña

M03520

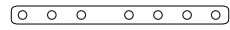

M03530

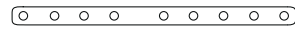

Aluminium
 Aluminum
 Aluminio



M01050
 12 x 84 mm



Pince pour cintrer les plaques
 Plate bending pliers
 Alicates para doblar placas



M03110
 15 cm - 6"



7 mm

M03120
 14 cm - 5 1/2"

Plaques
 Plates
 Placas

1,0 - 2,0 mm

M03125 

2,7 - 3,5 mm

M03126



M03125
 20 cm - 8"

Pince pour cintrer les plaques droites 4 et 6 mm
 Plate bender for straight plates 4 and 6 mm
 Pinza para doblar placas rectas 4 y 6 mm



Presse pour cintrer les plaques
 Bending press for plates
 Prensa para doblar placas



Guide mèche pour tendeur 8 et 16 mm
 Drill guide for tension device 8 and 16 mm
 Guía de perforación para tensor 8 y 16 mm



M03500

Tendeur de plaque
 Tension device for plate
 Tensor para placas



M03510
 Course 8 mm
 8 mm span
 Curso 8 mm



M035150
 Course 20 mm
 20 mm span
 Curso 20 mm

Clé pour tendeur
 Pin wrench for tension device
 Llave para tensor



M035160

Clé à cardan 11 mm
 Socket wrench 11 mm
 Llave cardan 11 mm



M01260
 17 cm - 6 3/4"

Clé mixte de 11 mm
 Open end wrench 11 mm
 Llave figa 11 mm

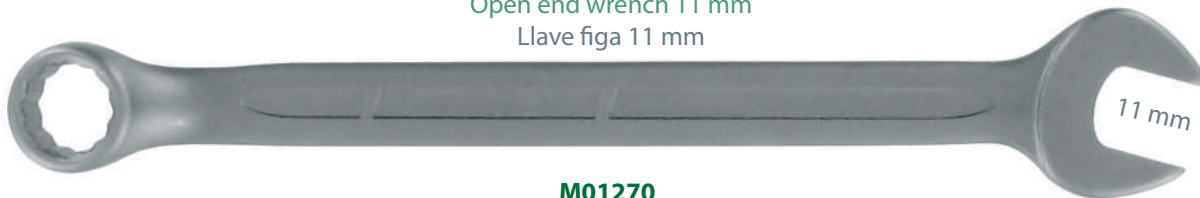

M01270
 16 cm - 6 1/4"



M01040
 20 cm - 8"



Ciseau à os - Osseous chisel - Cincel para huesos

Manche seul
Handle only
Mango solo



M02270
20,5 cm - 8"

Lame de burin
Bone chisel blade
Hoja de cincel



M02272
8 cm - 3 1/4"

Lame ostéotome
Osteotome blade
Hoja de osteotomo

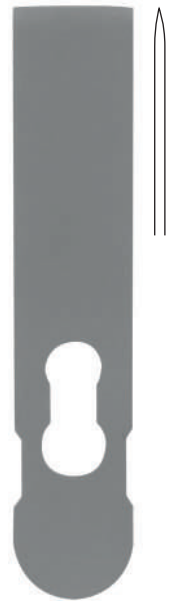

M022780
8 cm - 3 1/4"

M02274	5 mm	M022760
M02271	10 mm	M022770
M02272	16 mm	M022780
M02273	25 mm	M022790

Clé pour manche de burin
Wrench for bone chisel
Llave para mandril

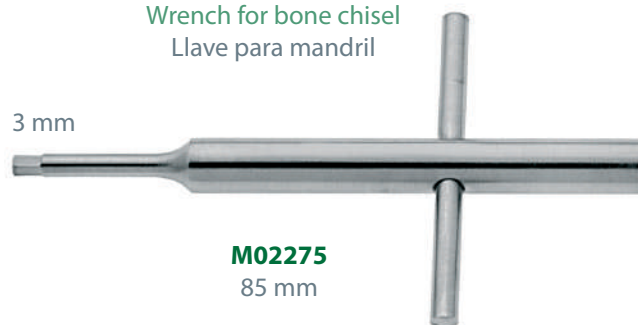

M02275
85 mm

LAMBOTTE

Porte-vis ou plaque
Screw Holder
Porta-tornillos o placa



J756900
17 cm - 6 ³/₄"

Pince pour mini plaque
Forceps for mini plates
Pinza para placa mini



M03170
13,5 cm - 5 ¹/₄"

Tord-broches
Iron for pins
Tubo para curvar agujas



Ø max
3,0 mm



Ø max : 2,0 mm

M03600
15 cm - 6"



2/3



M036010
30 cm - 11 ³/₄"

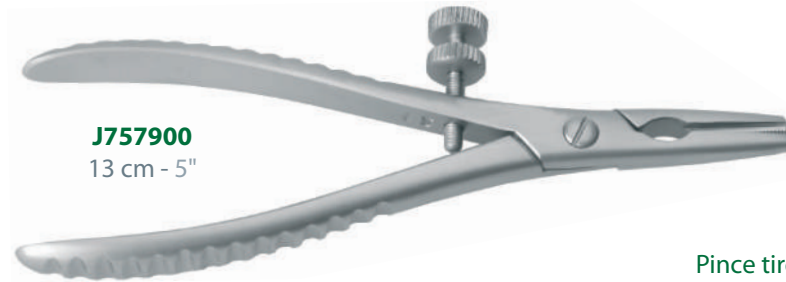

J757900
13 cm - 5"

Pince tire-broches
Wire seizing forceps
Pinza para coger agujas

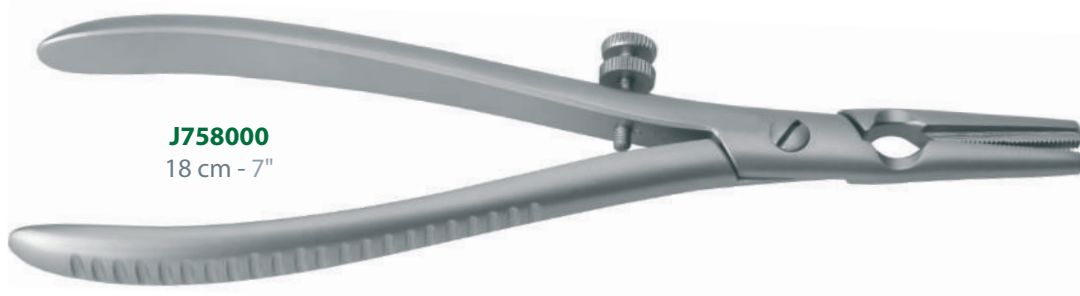

J758000
18 cm - 7"



J757420
15 cm - 6"



J757430
16 cm - 6 ¹/₄"

Pinces multiservices - Multiservices forceps - Pinzas multiservicios

Pince universelle
Universal forceps
Pinza universal



Coupe - Cut - Corte
Ø max : 1,5 mm

J757410
20 cm - 8"

Mors parallèles
Parallel jaws
Bocas paralelas



J759030
17 cm - 6 3/4"

Pinces étau - Vise grip forceps - Pinzas de fijación

18 cm - 7"

J759040



20 cm - 8"

J759041

24 cm - 9 1/2"

J759042



J759040
18 cm - 7"



J759050
25 cm - 10"

Pinces à fils métalliques - Wire pliers - Pinzas de alambre

Mors Tunstène - Tungsten jaws - Bocas Tungsteno

3 mm

6 mm



J758430
18 cm - 7"

J758431
18 cm - 7"

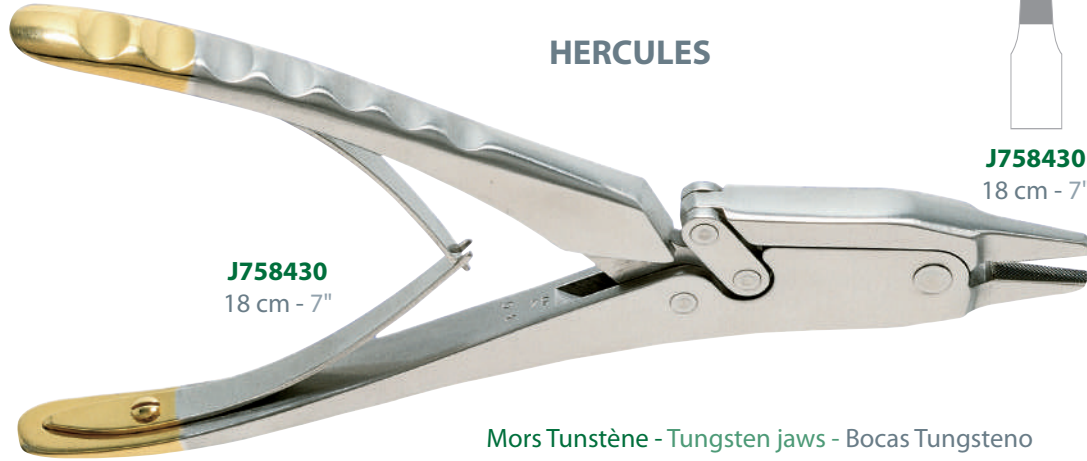

HERCULES

J758430
18 cm - 7"

Mors Tunstène - Tungsten jaws - Bocas Tungsteno

Mors inox
Stainless jaws
Bocas inox



 **J759060**
18 cm - 7"
3 mm

J759061
18 cm - 7"
4 mm

J759062
18 cm - 7"
6 mm

J759063
18 cm - 7"
5 mm

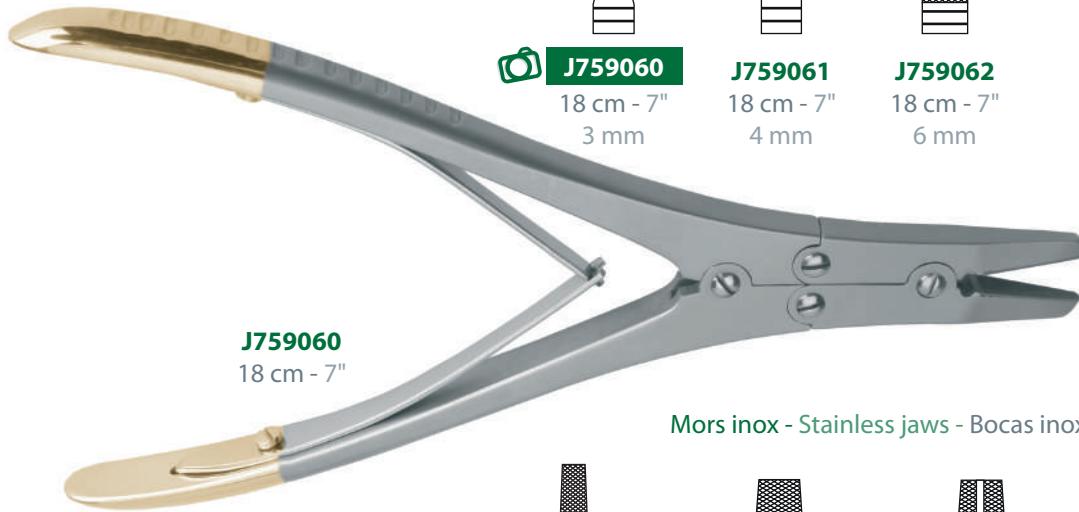

J759060
18 cm - 7"

Mors inox - Stainless jaws - Bocas inox



J759100
14 cm - 5 1/2"

J759105
17 cm - 6 3/4"

J759110 
17 cm - 6 3/4"

J759115
19 cm - 7 1/2"



J759110
17 cm - 6 3/4"

Pinces à fils métalliques - Wire pliers - Pinzas de alambre



Mors Tunstène - Tungsten jaws - Bocas Tungsteno



G306300



G30640

G30610

15 cm - 6"

19 cm - 7 1/2"

18 cm - 7"



Tendeur à fils - Wire tightener - Tensor de alambre

LOUTE

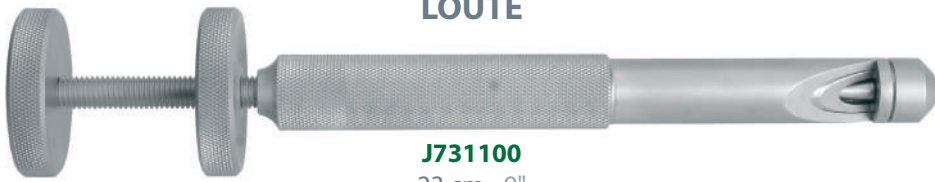

J731100

23 cm - 9"

DANIS



J731200

21 cm - 8 1/4"

HARRIS



J731300

25 cm - 10"

DEMEL



J731400

28 cm - 11"

COUPE LATÉRALE ET FRONTALE - LATERAL AND FRONTAL CUTTING - CORTE LATERAL Y FRONTAL



TC Inserts



Ø max : 1,7 mm

J757508
18 cm - 7"

COUPE FRONTALE - FRONTAL CUTTING - CORTE FRONTAL



Ø max : 2,0 mm

Mors inox
Stainless jaws
Bocas inox

J757506
16,5 cm - 6 1/2"



Ø max : 1,5 mm

J757510
15 cm - 6"



Ø max : 2,2 mm

J757520
22 cm - 8 3/4"

Pinces à couper les fils - Wire cutting pliers - Alicates para cortar alambre



TC Inserts



Ø max : 0,4 mm

J757490

12 cm - 4 ³/₄"



Ø max : 1,0 mm

M03080

15 cm - 6"

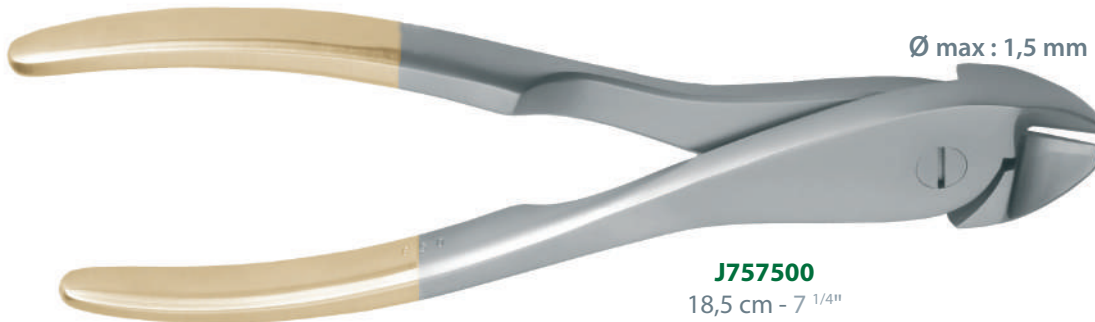

Ø max : 1,5 mm

J757500

18,5 cm - 7 ¹/₄"

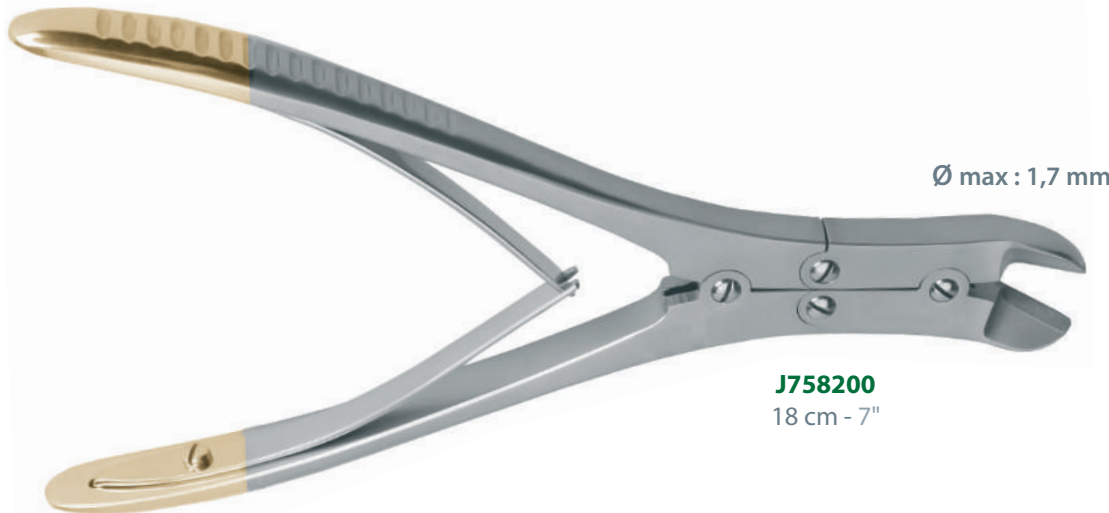

Ø max : 1,7 mm

J758200

18 cm - 7"

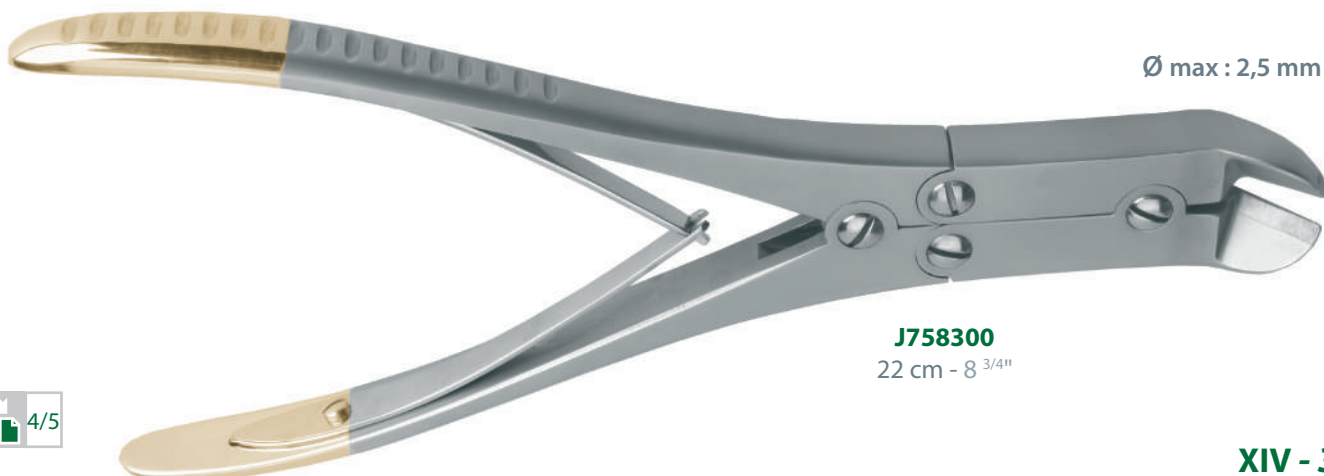

Ø max : 2,5 mm

J758300

22 cm - 8 ³/₄"

Pinces à couper les fils - Wire cutting pliers - Alicates para cortar alambre



J758042
57 cm - 22 1/2"

Ø max : 6.0 mm

J758040

47 cm - 18 1/2"

Ø max : 6.5 mm

J758042



57 cm - 22 1/2"

Mors seuls
Jaws only
Bocas solas

J758045



Ø max : 3 mm



J758010
32 cm - 12 1/2"

Ø max : 5 mm



J758050
47 cm - 18 1/2"

Mors seuls
Jaws only
Bocas solas

J758060





TC Inserts

Ø max : 3,0 mm

HERCULES



 **J758400**

Ø max : 3,0 mm
23 cm - 9"

J758403

Ø max : 3,5 mm
28 cm - 11"

Mors tungstène de rechange (paire)
Tungsten jaw for exchange (pair)
Boca de tungsteno de recambio (par)

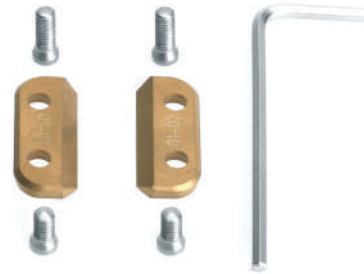

J758420 pour/for/para **J758400**

J758423 pour/for/para **J758403**

Mors caoutchouc de rechange (paire)
Rubber jaws for exchange (par)
Bocas caucho de recambio (par)



J758410



TC Inserts

HERCULES

Ø max : 2,2 mm



J758402
18 cm - 7"

Pour droitier
For right-handed
Para diestro

Mors tungstène de rechange (paire)
Tungsten jaw for exchange (pair)
Boca de tungsteno de recambio (par)

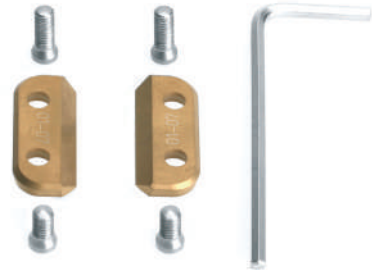

J758421

Mors caoutchouc de rechange (paire)
Rubber jaws for exchange (pair)
Bocas caucho de recambio (par)



J758410



J758401
18 cm - 7"

Pour gaucher
For left-handed
Para zurdo





TC Inserts

Ø max : 1,6 mm



J758406
15 cm - 6"

Mors caoutchouc de rechange (paire)
Rubber jaws for exchange (pair)
Bocas caucho de recambio (par)



J758416

Mors tungstène de rechange (paire)
Tungsten jaw for exchange (pair)
Boca de tungsteno de recambio (par)



J758426

HERCULES

Ø max : 2,0 mm



J758407
18 cm - 7"



PINCE POUR TORSADER ET COUPER LES FILS.
NE PAS UTILISER POUR LA TRACTION DES BROCHES.
PLIERS FOR TWISTING AND CUTTING THE WIRES.
DO NOT USE FOR THE PINS TRACTION.
ALICATE PARA TORCER Y CORTAR LOS ALAMBRES.
NO USO PARA EXTRACCIÓN DE PINES.



TC Inserts

HERCULES

Coupe latérale
Lateral cutting
Corte lateral

Ø max : 2,0 mm

Coupe latérale et frontale
Lateral and frontal cutting
Corte lateral y frontal

Ø max : 1,6 mm



J758405
18 cm - 7"

Mors tungstène de rechange (paire)
Tungsten jaw for exchange (pair)
Boca de tungsteno de recambio (par)

J758425

Coupe câble
Cable cut
Corta cables



J758404
18 cm - 7"

Mors tungstène de rechange avec protection caoutchouc (paire)
Tungsten jaw for exchange with rubber protection (pair)
Boca de tungsteno de recambio con protección de caucho (par)

J758424

MICHELE

Pour enlever les vis cassées
For removal broken screws
Para Retirar los tornillos rotos



M006050

3,0 - 5,0 mm



M006055

4,0 - 6,0 mm



M006080

6,0 - 8,0 mm



M006055
19,5 cm - 7 ²/₃"

LUCAS-CHAMPIONNIERE

Fixe
Fixed
Fijo

Ø 3 mm



J94150
17 cm - 6 ³/₄"

NELATON

Perforateur complet avec 3 forets
Complete perforator with 3 drills
Perforador completo con 3 bocas

Foret seul
Drill only
Broca sólo

9,5 cm - 3 ³/₄"

Ø

2 mm

J94170

3 mm

J94180

4 mm





J94190



J94160
12 cm - 4 ³/₄"



M002200
15 cm - 6"

Ø 3,0 mm	M03200 	Ø 2,4 mm	M03240 	Ø 2,4 mm	M03291	Ø 2.0 x 3 mm	M03250 
Ø 3,5 mm	M03201	Ø 3,0 mm	M03241	Ø 3,0 mm	M03290 	Ø 3.0 x 4 mm	M03280
Ø 4,0 mm	M03202						
Ø 5,0 mm	M03203						

Pour clous Kuntscher
For Kuntscher nails
Para clavos Kuntscher



M03200
Ø 3,0 mm
60 cm - 23 3/4"

Droit
Straight
Recto



M03240
Ø 2,4 mm
90 cm - 35 1/2"

Pour clous IM
For IM nails
Para clavos IM

Courbe
Curved
Curvo



M03290
Ø 3,0 mm
90 cm - 35 1/2"

Pour alésoir flexible
For flexible reamer
Para broca flexible

Ø 3,0 mm



M03250
Ø 2,0 mm
90 cm - 35 1/2"



Perforateur initial
Initial drill
Perforador inicial

J94020
27 cm - 10 ³/₄"



Alésoir
Reamer
Broca

M00250
34 cm - 13 ¹/₂"



Marteau diapason - Slotted hammer - Martillo diapason



M02170
27 cm - 10 ³/₄"



M02190
26 cm - 10 ¹/₄"



Instrumentation pour enclouage IM - Instruments for IM nails - Instrumentación para clavos IM

Guide clou fendu
Slotted nail driver
Conductor clavo ranurado



M020220
20 cm - 8"

Impacteur final
Final impactor
Impactor final

Ø 6 - 8 mm
Ø 9 - 12 mm
Ø 13 - 20 mm

M020230
M020231
M020232



M020230
20 cm - 8"

Crochet d'extraction
Extraction hook
Gancho de extracción

29 cm - 11 1/2"
37 cm - 14 1/2"
43 cm - 17"
51 cm - 20"

M02000
M02001
M02002
M02003

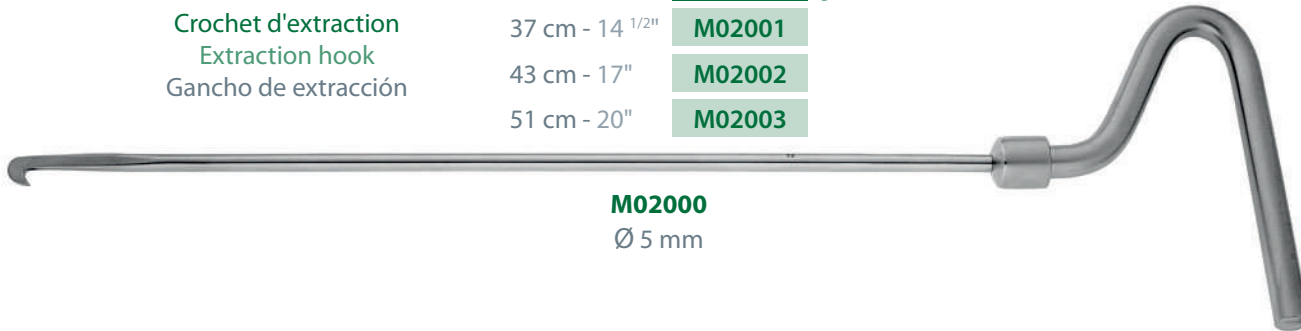

M02000
Ø 5 mm

Arrache clou à masse coulissante avec 2 crochets
Nail extractor with 2 hooks - sliding Mallet
Extractor de clavos con 2 ganchos



M02010
63 cm - 24 3/4"

Crochets seuls - Hooks only - Ganchos solo

Petit - Small - Pequeño

Grand - Large - Largo



M02020
9 cm - 3 1/2"

M02021
9 cm - 3 1/2"

Alésoirs
Reamers
Brocas

- Ø 6,4 mm **M00300** 
- Ø 4,8 mm **M00301**
- Ø 3,2 mm **M00302**
- Ø 2,4 mm **M00303**

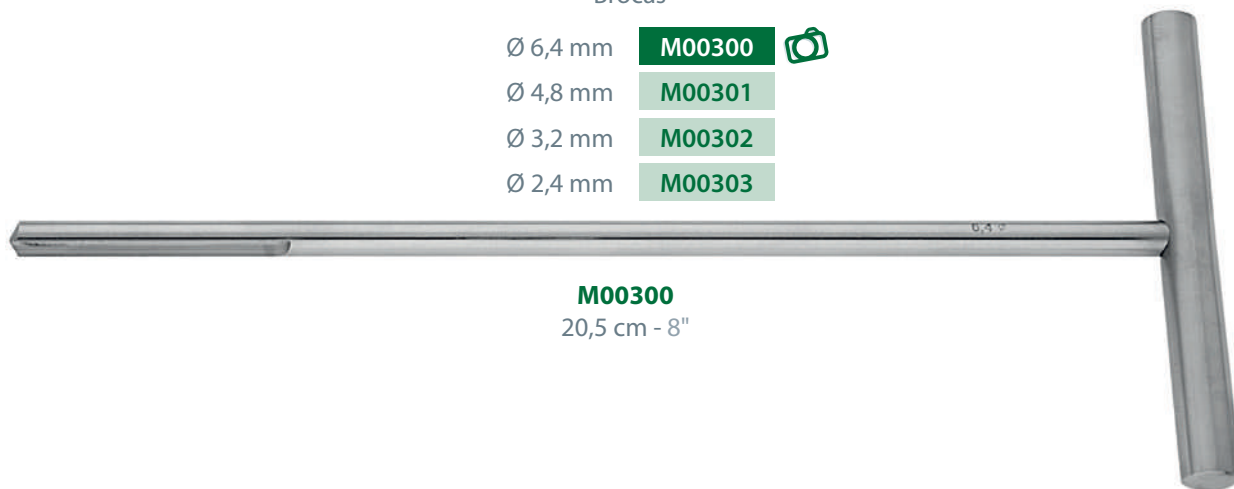

M00300
20,5 cm - 8"

Guide et extracteur
Driver and extractor
Conductor y extractor

- 6,4 x 18 mm **M03210** Ø 6,6 mm
- 4,8 x 14 mm **M03211** Ø 5,0 mm 
- 3,2 x 10 mm **M03212** Ø 3,6 mm
- 2,4 x 8 mm **M03213** Ø 2,7 mm



M03211
19 cm - 7 1/2"



Fer à cintrer les clous de RUSH et clous à palette
Plate bender for RUSH nails and palet nails
Llave para doblar clavos de RUSH y clavos paleta



M01000
20,5 cm - 8"

Pousse clou
Nail inserter
Impactor

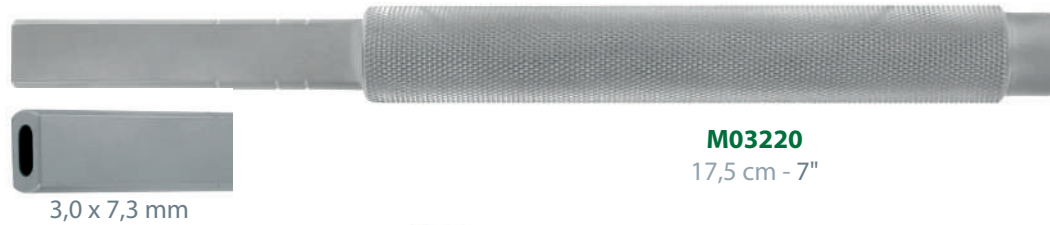

M03220
17,5 cm - 7"

3,0 x 7,3 mm

Guide clou
Impactor guide
Mango impactor - conductor

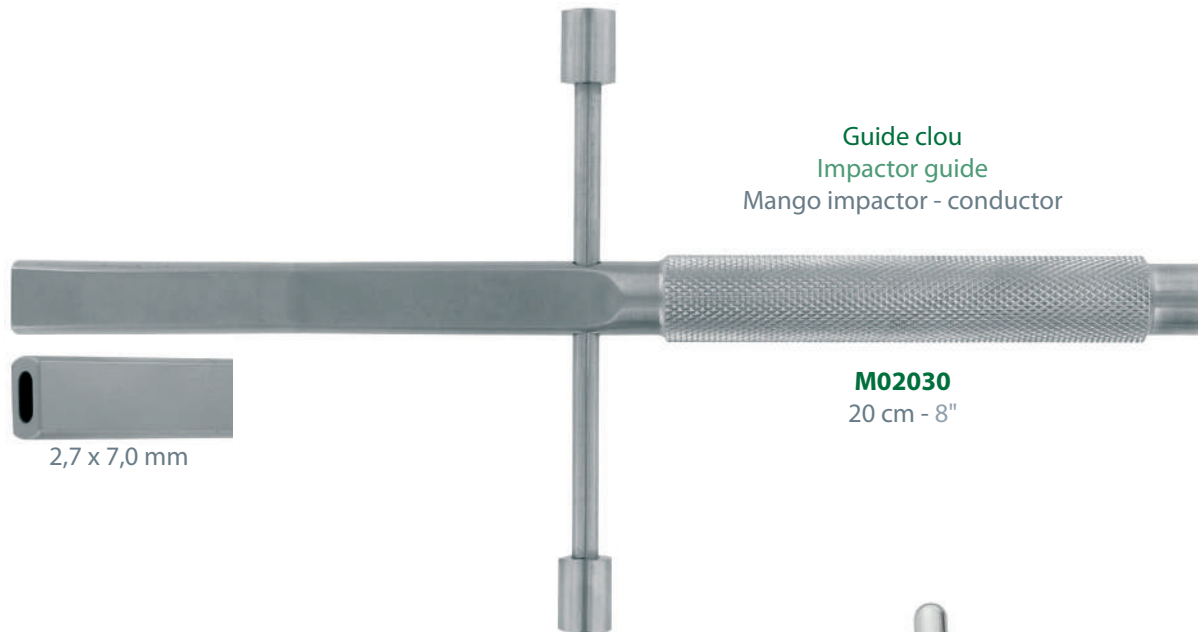

M02030
20 cm - 8"

2,7 x 7,0 mm

Impacteur extracteur
Impactor extractor
Impactor extractor

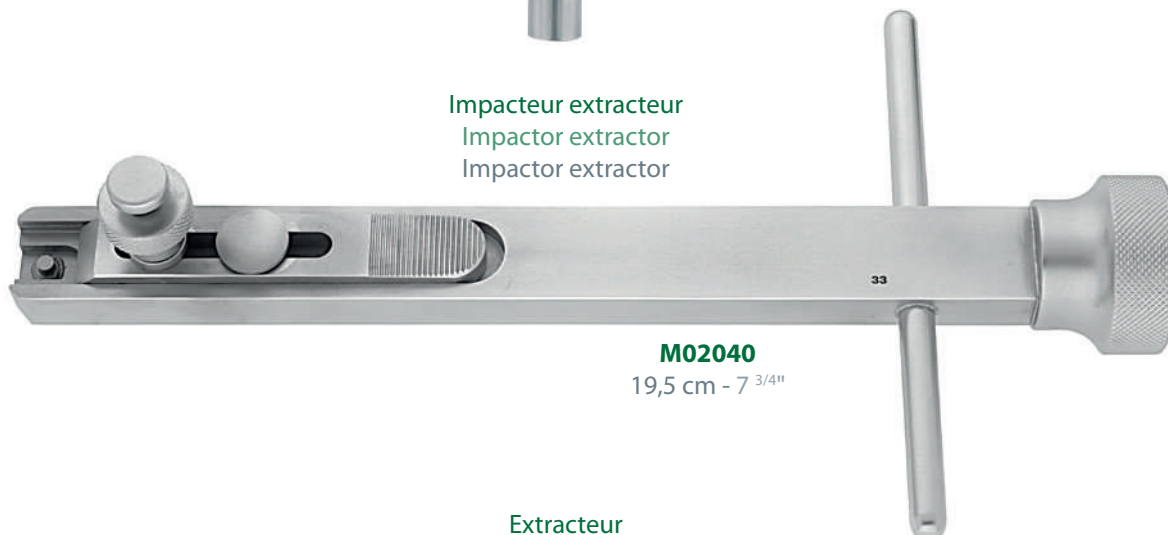

M02040
19,5 cm - 7 ³/₄"

Extracteur
Extractor hook
Gancho extractor



M02050
39,5 cm - 15 ¹/₂"

2/5

4/5



Impacteur pour clous élastiques (sans mandrin)
Impactor for gliding nails (without sleeve)
Impactor para clavos flexible (sin mandril)



Mandrin de centrage
Centering sleeve
Mandril para centrar

M02092

Pour clous
For nails
Para clavos

Ø 1,5 - 2,0 mm **M02090**

Ø 2,5 - 3,0 mm **M02091**

Ø 3,5 - 5,0 mm **M02092**

Pince extractrice
Extraction forceps
Pinza de extracción



M03050
22 cm - 8 ³/₄\"/>

Impacteur de clous
Nails impactor
Impactor de clavos

Ø 3,0 mm



M02071
15,5 cm - 6\"/>

Pour clous
For nails
Para clavos

Ø 1,5 - 2,5 mm

M02070

Ø 2,5 - 3,0 mm

M02071



Ø 3,5 - 5,0 mm

M02072



Jauge pour alésoirs, clous et vis
Reamer, nails and screw template
Medidor para brocas, clavos, tornillos

M03001
180 x 75 mm

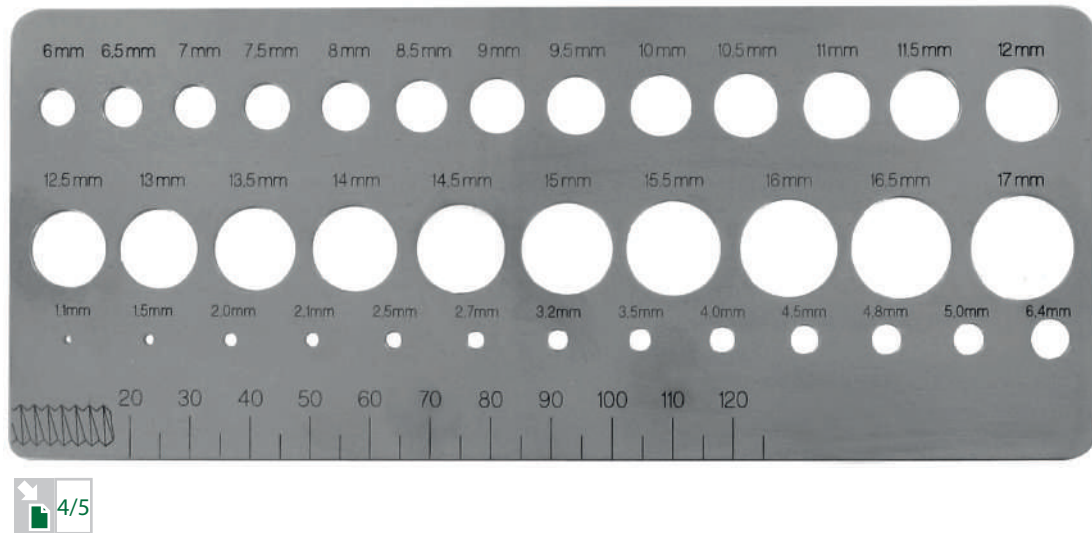

Jauge pour broches
Pins template
Medidor para agujas

M030030
15 cm - 6"

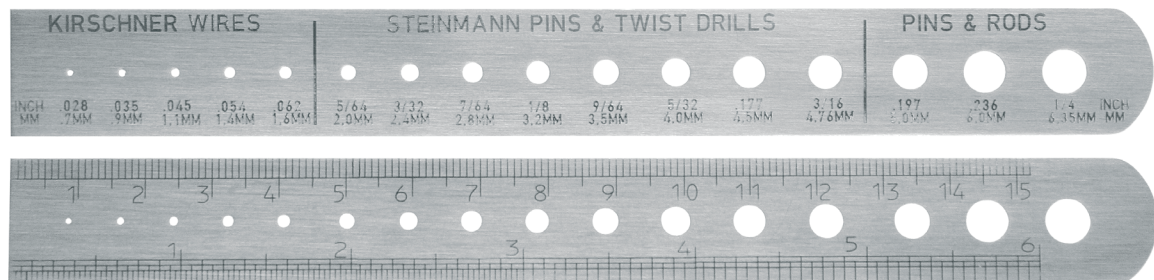

- Ø 3,5 mm **M00400**
- Ø 4,5 mm **M00390**
- Ø 7,0 mm  **M00391**

Mandrin perforé
Cannulated chuck
Mandril canulado

AO



Ø 2,3 mm

M003890

9,5 cm - 3 3/4"



AO



M004001

16 cm - 6 1/4"

Ø 3,5 mm

Taraud perforé
Cannulated tap
Terraaja canulado

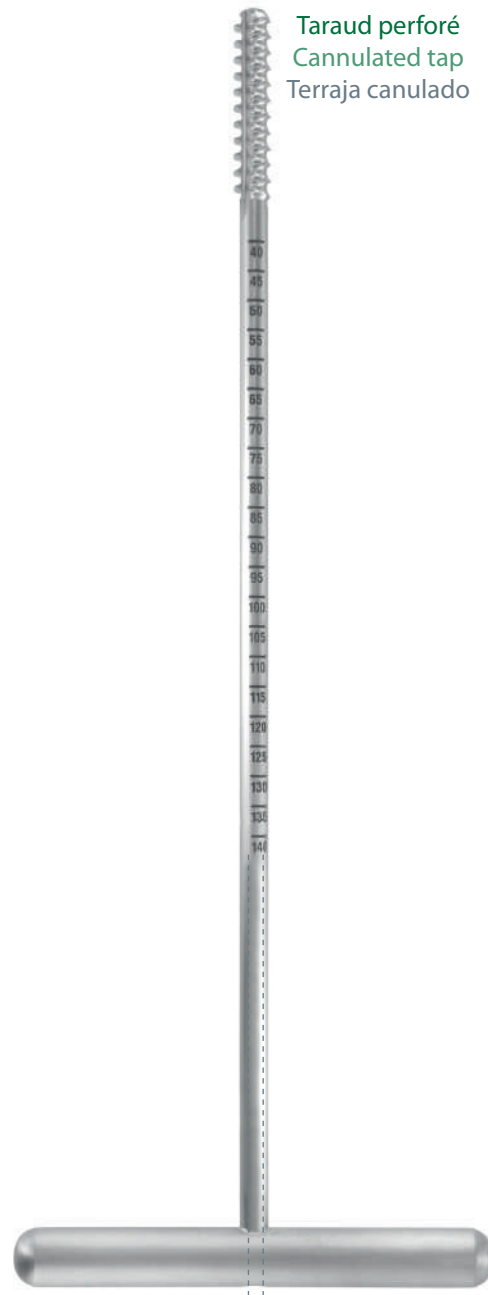

Ø 2,1 mm

M00391

21,5 cm - 8 1/2"

Ø 7,0 mm



Broche guide Guide pin Aguja guía



Broche Pin Aguja		Pour vis For screw Para tornillo
Ø 1,0 mm	M03355	Ø 3,5 mm
Ø 1,6 mm	M03356	Ø 4,5 mm
Ø 2,0 mm	M03357	Ø 7,0 mm



Tige de nettoyage - Canal cleaner - Hilo para limpiar

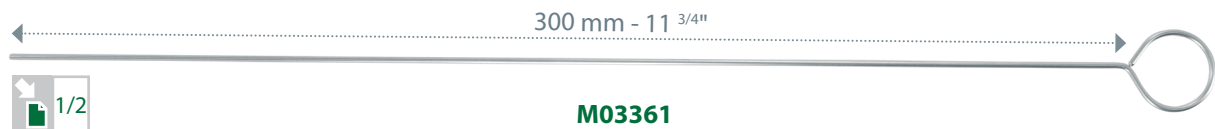

M03361

Ø 2,0 mm	300 mm	M03360
Ø 1,6 mm	300 mm	M03361
Ø 1,2 mm	300 mm	M03362



Tournevis pour vis perforées - Screw driver for cannulated screw - Atornillador para tornillos canulados



2,5 mm
Ø 1,3 mm

Pour vis Ø 3,5 mm
For screw Ø 3,5 mm
Para tornillos Ø 3,5 mm



M01080
20 cm - 8"



3,5 mm
Ø 1,8 mm

Pour vis Ø 4,5 mm
For screw Ø 4,5 mm
Para tornillos Ø 4,5 mm



M01070
22 cm - 8 3/4"



5,0 mm
Ø 2,2 mm

Pour vis Ø 7,0 mm
For screw Ø 7,0 mm
Para tornillos Ø 7,0 mm



M01060
24 cm - 9 1/2"

M01060

Pour agrafes épiphysaires - For epiphyseal staples - Para grapas para epifisis

Extracteur à agrafes
Staples extractor
Extractor de grapas



M02100
20,5 cm - 8"

Impacteur à agrafes
Staples inserter
Impactor de grapas



M02110
16 cm - 6 1/4"

Porte agrafes
Staples driver
Porta grapas



M02120
16 cm - 6 1/4"

Impacteur
Impactor
Impactor



M02122
24,5 cm - 9 ³/₄"

Impacteur pour agrafes épiphysaires
Impactor for epiphyseal staples
Impactor para grapas para epifisis

M02124
16,5 cm - 6 ¹/₂"

Impacteur pour agrafes décalées
Impactor for stepped staples
Impactor para grapas escalonadas

M02126
16,5 cm - 6 ¹/₂"



M02124
16,5 cm - 6 ¹/₂"

TENDEUR DE FILS - WIRE TIGHTENER - TENSOR DE ALAMBRE

M037050

Clé seule
Key only
Llave sola



2 x Ø 2,7 mm

M03700

24,5 cm - 9 ³/₄"



Ø 2,3 mm

M03710

13 cm - 5 ¹/₄"

GUIDE FIL - WIRE PASSER - PASAHILOS



M03745

22 cm - 8 ²/₃"

Ø 45 mm



M03770

23,5 cm - 9 ¹/₄"

Ø 70 mm

Marteau à réflexes - Percussion hammers - Martillos a reflejos



Abaisse langue - Tongue depressor - Depresor lingual

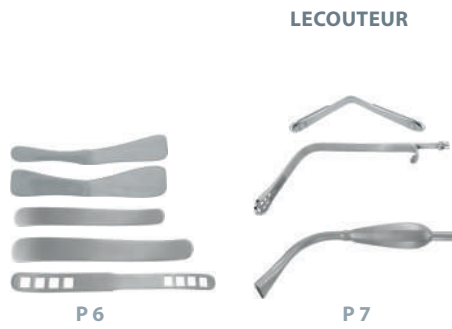

Miroir laryngien - Laryngeal mirror - Espejo laríngeo



Instrumentation de service - Instrumentation for services - Instrumentación de servicio

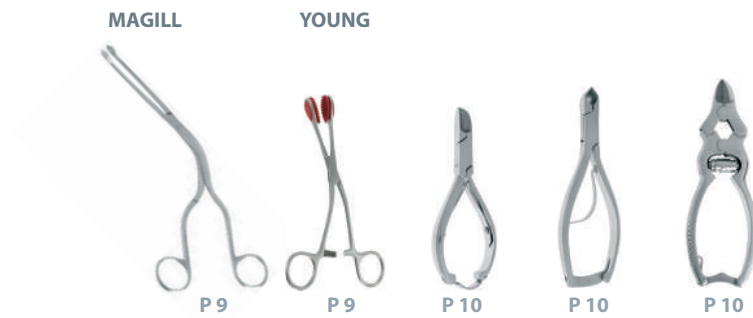

Scie coupe-bague - Saw to cut the ring - Sierra para cortar los anillos



Stylets - Probes - Estiletos



Sondes cannelées - Fluted directors - Sondas acanaladas

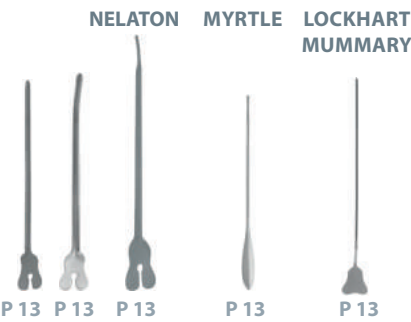

Porte-coton - Cotton holder - Porta algodón



Instrumentation de service - Instrumentation for services - Instrumentación de servicio

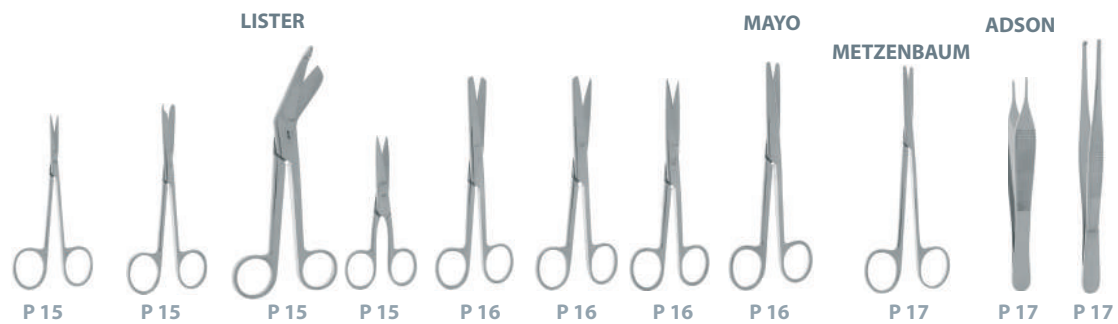

Instrumentation de service - Instrumentation for services - Instrumentación de servicio

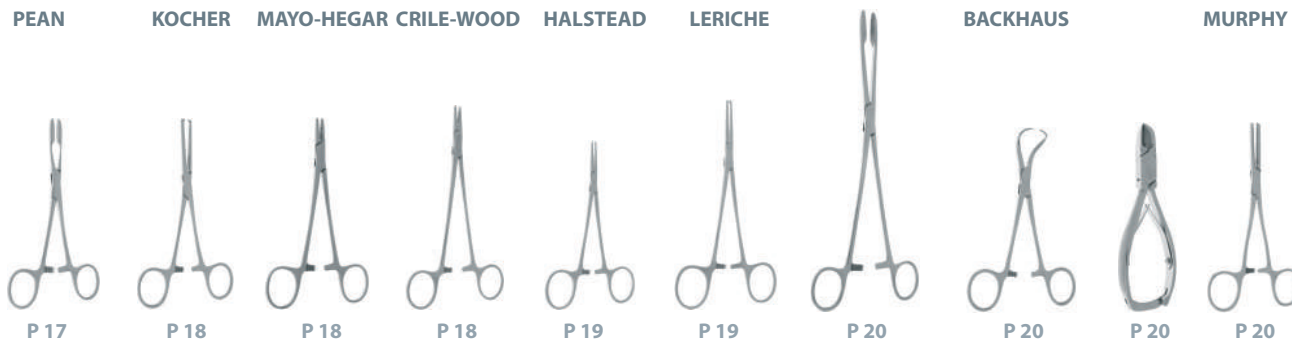

Pincas diverses - Miscellaneous forceps - Pinzas diversas



Ciseaux pour plâtre - Plaster scissors - Tijeras para escayolas



Pincas pour plâtres - Plaster forceps - Pinza para escayolas

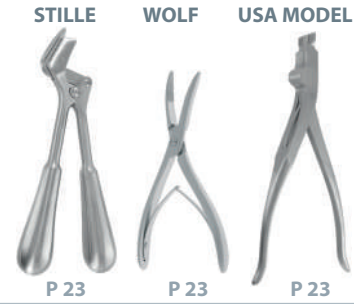

Pincas pour plâtres - Plaster forceps - Pinzas para escayolas



Attelles malléables - Malleables splints - Tablillas maleables



Canules - Cannulas - Cánulas

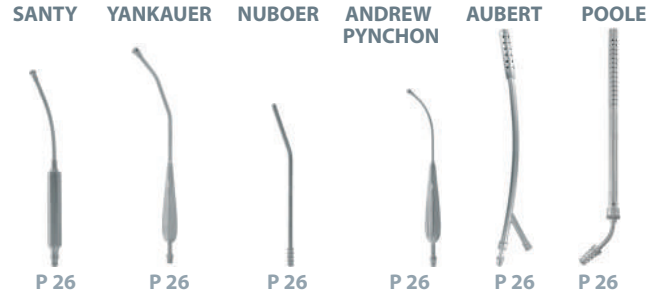

Canules - Cannulas - Cánulas Trocarts - Trocars - Trocares

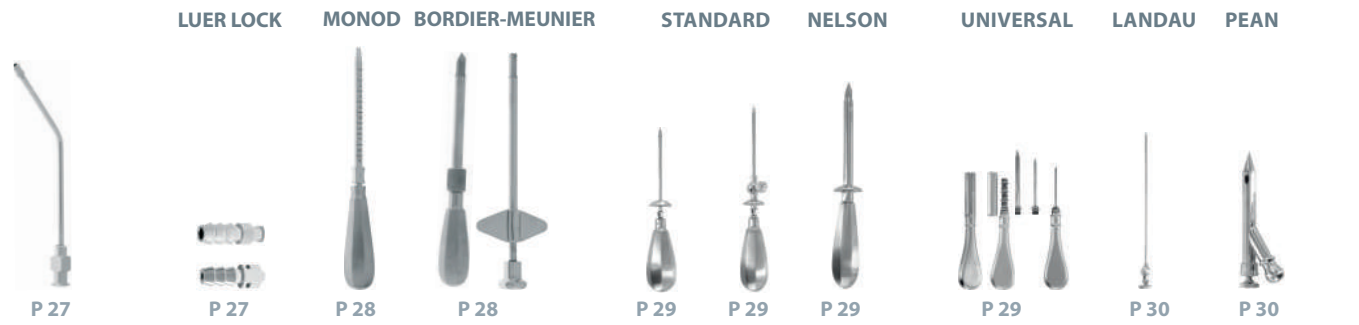

Trocarts - Trocars - Trocares



Matériels divers - Miscellaneous materials - Materiales varios

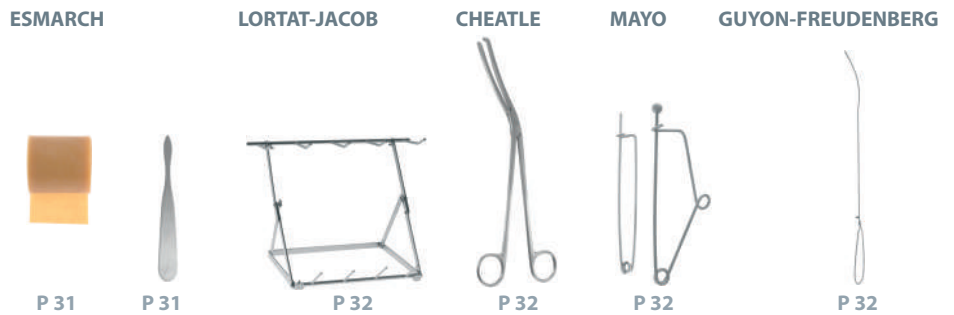

Matériels divers - Miscellaneous materials - Materiales varios



Instruments pour plâtres - Plaster instruments - Instrumentos para escayolas

III - Ciseaux
III - Scissors
III - Tijeras



P 85

P 85

O.R.L. canules aspiratrices - E.N.T. suction tubes - O.R.L. canulas aspirantes

XII - O.R.L.
XII - E.N.T.
XII - O.R.L.

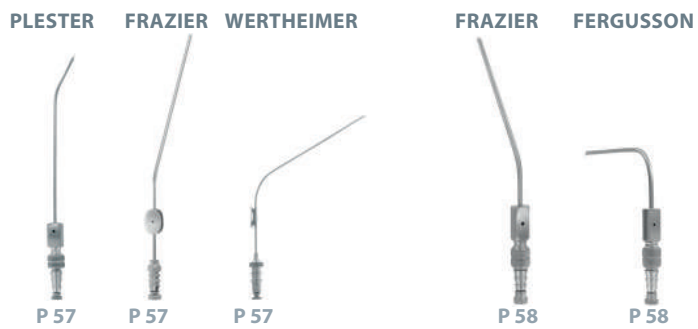

P 57

P 57

P 57

P 58

P 58

BABINSKY



Caoutchouc pour Babinsky
Rubber for Babinsky
Caucho para Babinsky



A05020

A05010
23 cm - 9"

VERNON



Caoutchouc pour Vernon
Rubber for Vernon
Caucho para Vernon



A05060

A05050
18 cm - 7 1/4"

PINARD

STÉTHOSCOPE
STETHOSCOPI
ESTETOSCOPIO



Aluminium
Aluminum
Aluminio



A15160
15 cm - 6"



Abaisse langue - Tongue depressor - Depresor lingual

Coudé pour enfants
Angled for children
Acodado para niños



Coudé pour adultes
Angled for adults
Acodado para adultos



MAYO



BRUENINGS



LECOUTEUR



A300020

15,5 cm - 6 ¹/₅"

26 mm

22 mm

LE MEE

20 cm - 8"



A300030

23 mm

A300040

30 mm



A300030

20 cm - 8"

Avec aspiration
With suction
Con succión

23 mm



A300050

22 cm - 8 ³/₄"

Avec aspiration
With suction
Con succión

26 mm

Miroir laryngien - Laryngeal mirror - Espejo laringeo

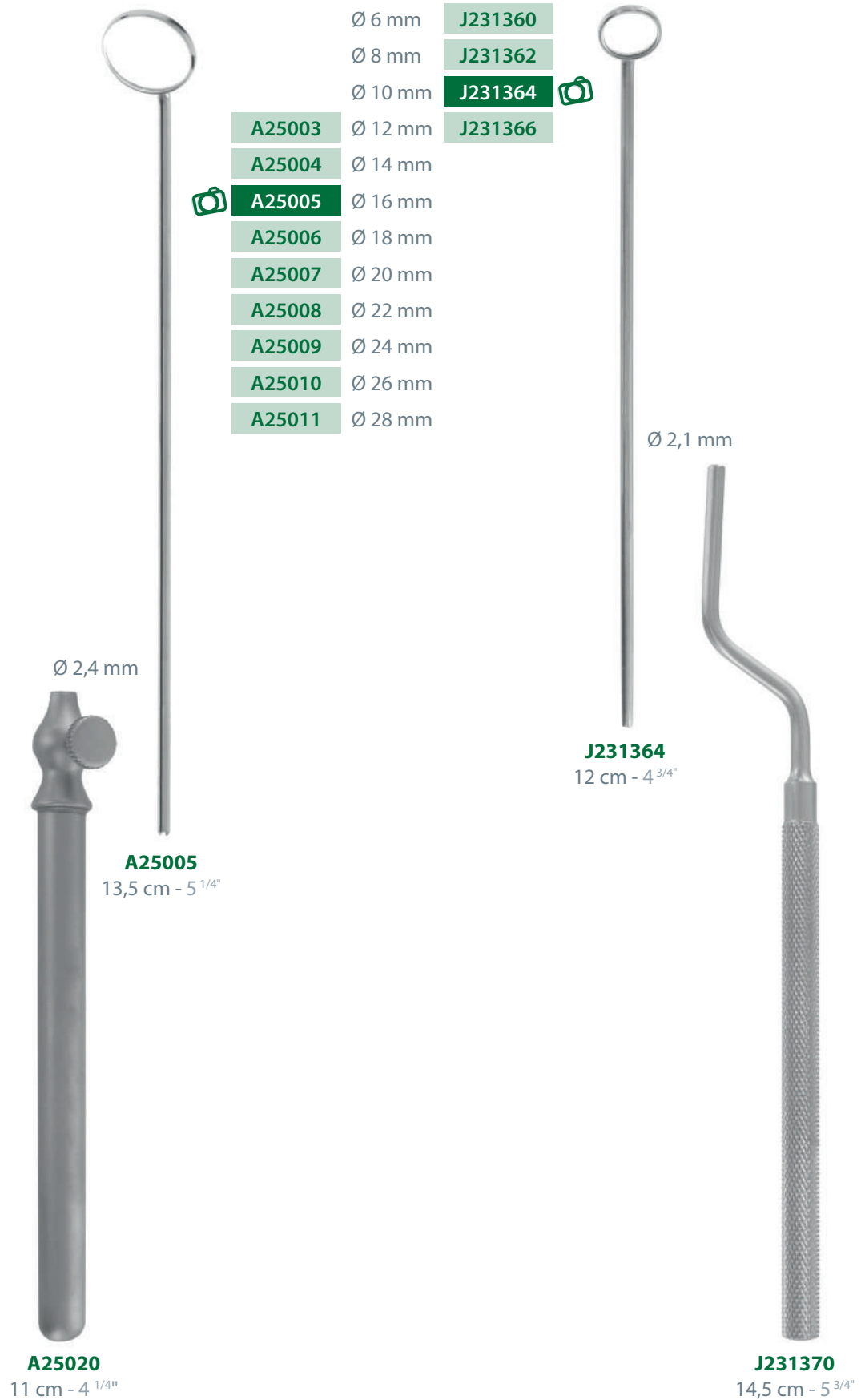

MAGILL

PINCES À SONDES
CATHETER FORCEPS
PINZAS PARA SONDAS



Adultes
Adults
Adultos

A30060
22 cm - 8 ³/₄"

YOUNG

PINCE TIRE-LANGUE
TONGUE HOLDING FORCEPS
PINZA PARA TIRAR LA LENGUA



A30090
16,5 cm - 6 ¹/₄"

Enfants
Children
Niños

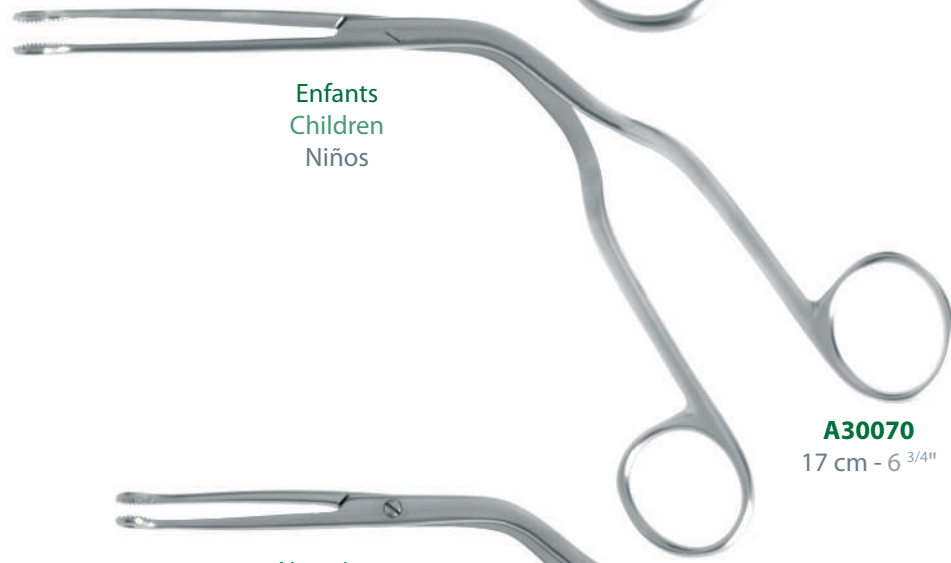

A30070
17 cm - 6 ³/₄"

Nourrissons
Babies
Niños de pecho



A30075
15 cm - 6"

Mors caoutchouc (paire)
Rubber jaws (pair)
Bocas de goma (par)



A30095
(pour/for/para A30090)

PINCES À ONGLES - NAIL CUTTERS - PINZAS PARA UÑAS



A86010
11 cm - 4 1/4"



A86020
13 cm - 5"



Oblique
Oblique
Oblicuo

A86060
14 cm - 5 1/2"



A860300
13 cm - 5"



A85030
14 cm - 5 1/2"



A85040
15 cm - 6"

LANDANGER

Scie coupe-bague - Saw to cut the ring - Sierra para cortar los anillos



! Acier chromé
Chrome steel
Acero cromado

A85160

18,5 cm - 7 1/4"

Pour or et argent
For gold and silver
Para oro y plata

Avec une lame **A85170**
With one blade **A85170**
Con una hoja **A85170**



! Acier carbone
Carbone steel
Acero carbono

Ø 30 mm **A85170**
(pour/for/para A85160)



A851800
15 cm - 6"

Avec une lame **A851810**
With one blade **A851810**
Con una hoja **A851810**

Pour or et argent
For gold and silver
Para oro y plata

Ø 30 mm **A851810**
(pour/for/para A851800)

Pour acier
For steel
Para acero

Ø 30 mm **A851820**
(pour/for/para A851800)



! Acier carbone
Carbone steel
Acero carbono



Stylets - Probes - Estiletos

WATSON
CHEYNE

FISH

Ø 1,5 mm

Ø 2 mm

Double
Double
Doble
Ø 2 mm

Simple
Simple
Simple
Ø 2 mm

Cannelé
Fluted
Acanalado
Ø 2 mm

Aiguillé
With eye
Agujada
Ø 2 mm



Ø 1,0 mm

14 cm - 5 1/2"

A800110

Ø 1,5 mm

13 cm - 5 1/4"

A800151

14 cm - 5 1/2"

A800152

16 cm - 6 1/4"

A800153

18 cm - 7"

A800154

20 cm - 8"

A800155

Ø 2,0 mm

14 cm - 5 1/2"

A80020



16 cm - 6 1/4"

A800201

18 cm - 7"

A800202

20 cm - 8"

A800203

25 cm - 9 3/4"

A800204

Ø 2 mm

Ø 2 mm

2 mm

5 mm

3.7 mm

A80020

A80010

A80030

A80040

A800410

A800420

14 cm - 5 1/2"

14 cm - 5 1/2"

14 cm - 5 1/2"

14 cm - 5 1/2"

18 cm - 7"

18 cm - 7"

LANDANGER

Sondes cannelées - Fluted directors - Sondas acanaladas

LOCKHART
MUMMARY

- 12 cm - 4 3/4" **A80070**
- 14 cm - 5 1/2" **A80080** 
- 16 cm - 6 1/4" **A80090**
- 20 cm - 8" **A800910**

NELATON

MYRTLE

Courbe
Curved
Curva

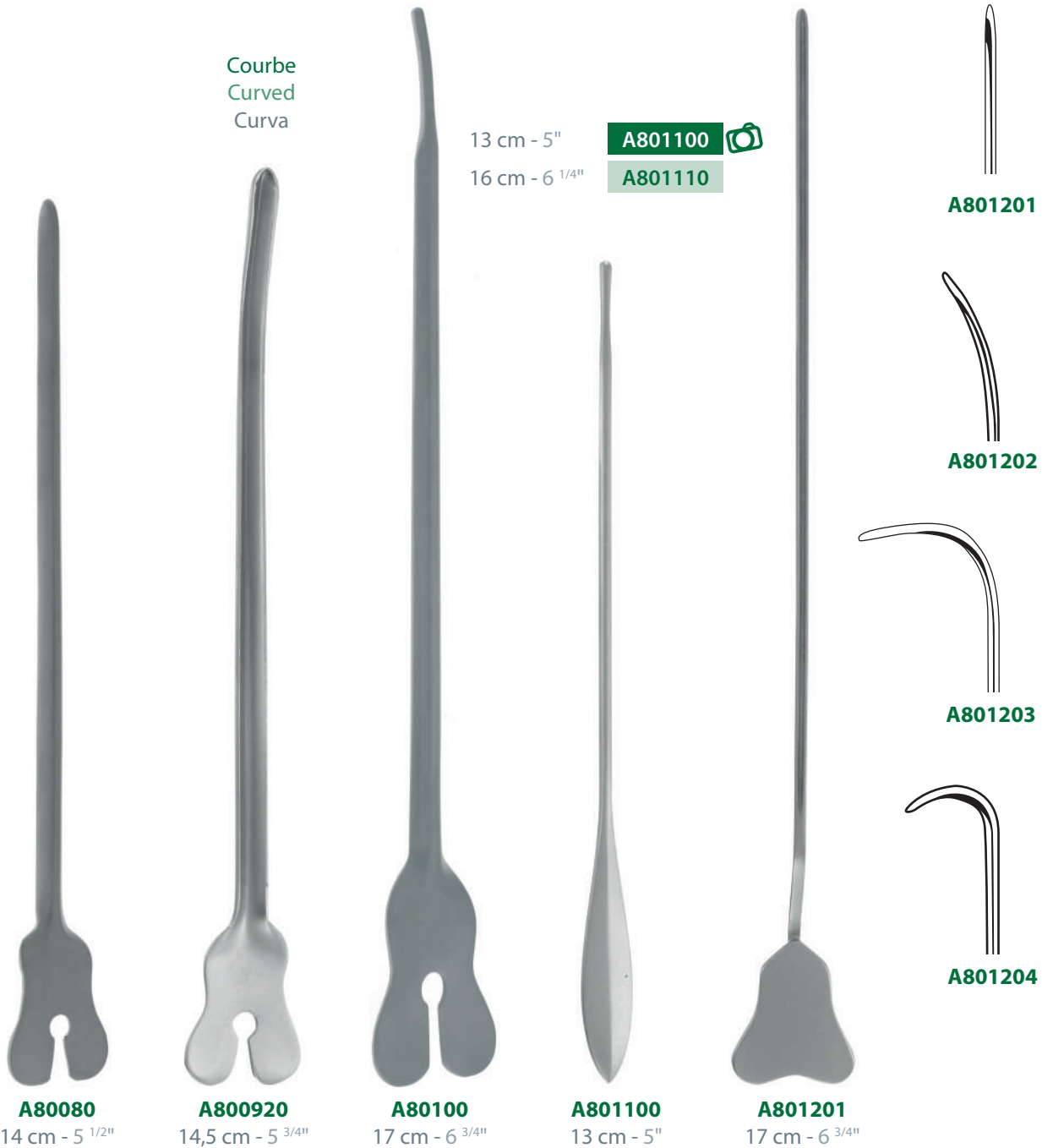



A80050
14 cm - 5 1/2"



A80150
30 cm - 11"



A80140
40 cm - 15 3/4"





LISTER

14 cm - 5 1/2" **B890375**

18 cm - 7" **B89038** 



CISEAUX À ONGLES

NAIL SCISSORS
TIJERAS PARA UÑAS

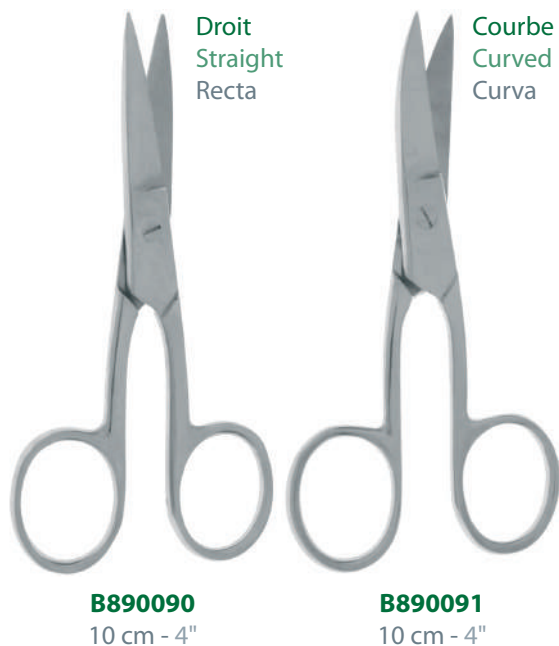

CISEAUX MOUSSES
BLUNT SCISSORS
TIJERAS ROMAS



Droit
Straight
Recta

B89010
14 cm - 5 1/2"



Courbe
Curved
Curva

B89015
14 cm - 5 1/2"

CISEAUX DAUPHIN - POINTU/MOUSSE
SHARP/BLUNT SCISSORS
TIJERAS AGUDAS/ROMAS



Droit
Straight
Recta

B89020
14 cm - 5 1/2"



Courbe
Curved
Curva

B89025
14 cm - 5 1/2"

MAYO

CISEAUX POINTUS
SHARP SCISSORS
TIJERAS AGUDAS



Droit
Straight
Recta

B89030
14 cm - 5 1/2"



Courbe
Curved
Curva

B89035
14 cm - 5 1/2"

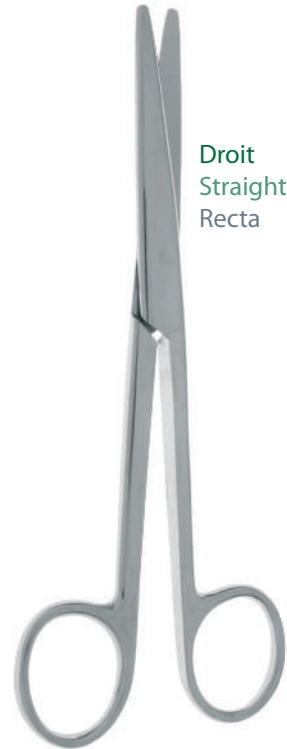

Droit
Straight
Recta



B89036
15 cm - 6"



Courbe
Curved
Curva



B89037
15 cm - 6"

METZENBAUM

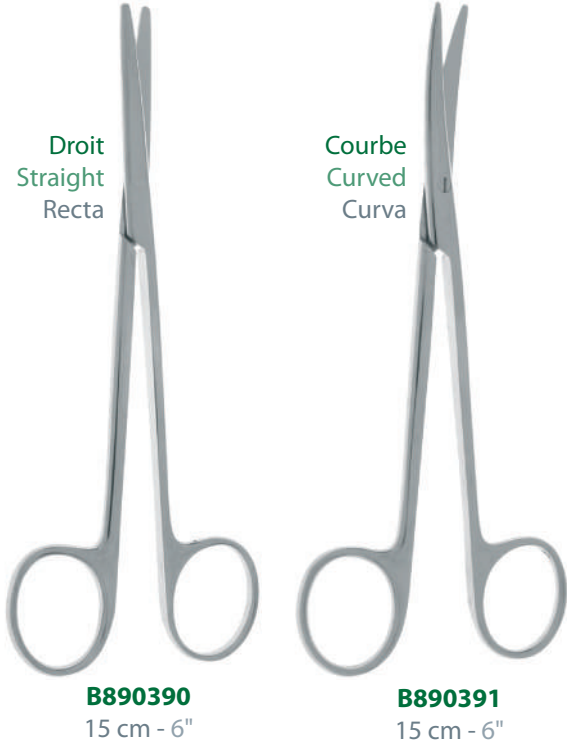
- | | | | | |
|-----------------------------------------------------------------------------------|----------------|------------|----------------|-----------------------------------------------------------------------------------|
|  | B890390 | 15 cm - 6" | B890391 |  |
| | B890392 | 18 cm - 7" | B890393 | |



PINCE À DISSECTION DISSECTION FORCEPS PINZAS PARA DISECCIÓN

- | | | | | |
|-----------------------------------------------------------------------------------|---------------|----------------|---------------|-------------------------------------------------------------------------------------|
|  | B89040 | 14 cm - 5 1/2" | B89045 |  |
| | B89050 | 16 cm - 6 1/4" | B89055 | |

Fine - Fine - Aguda

- | | | |
|----------------|----------------|----------------|
| B890460 | 14 cm - 5 1/2" | B890461 |
|----------------|----------------|----------------|



ADSON

- | | |
|-----------------------------------------------|-----------------------------------------------------|
| A griffes
With teeth
Con dientes | Sans griffes
Without teeth
Sin dientes |
|-----------------------------------------------|-----------------------------------------------------|

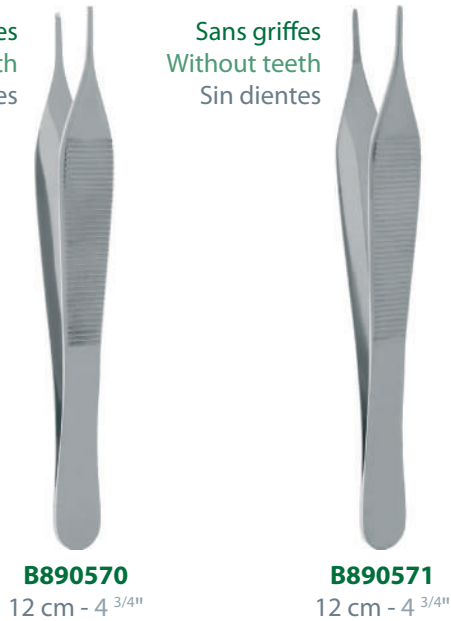

PEAN



KOCHER

Droite
Straight
Recta

Courbe
Curved
Curva

<p>A griffes With teeth Con dientes</p> 	<p>Sans griffes Without teeth Sin dientes</p> 	<p>A griffes With teeth Con dientes</p> 	<p>Sans griffes Without teeth Sin dientes</p> 
<p>14 cm - 5 1/2" B89061 </p> <p>16 cm - 6 1/4" B89065</p>	<p>14 cm - 5 1/2" B89062 </p> <p>16 cm - 6 1/4" B89066</p>	<p>14 cm - 5 1/2" B89063 </p> <p>16 cm - 6 1/4" B89067</p>	<p>14 cm - 5 1/2" B89064 </p> <p>16 cm - 6 1/4" B89068</p>

PORTE-AIGUILLE - NEEDLE HOLDER - PORTA AGUJAS

MAYO-HEGAR

CRILE-WOOD

 <p>B89070 14 cm - 5 1/2"</p>	 <p>B89072 16 cm - 6 1/4"</p>	 <p>B890740 15 cm - 6"</p>	 <p>B890750 15 cm - 6"</p> <p> TC Inserts</p>
-----------------------------------------------------------------------------------------------------------------------------	-----------------------------------------------------------------------------------------------------------------------------	----------------------------------------------------------------------------------------------------------------------------	----------------------------------------------------------------------------------------------------------------------------------------------------------------------------------------------------------------------------------------

HALSTEAD

PINCE DROITE
STRAIGHT FORCEPS
PINZA RECTA



A griffes
With teeth
Con dientes

Sans griffes
Without teeth
Sin dientes

B89140
12 cm - 4 ³/₄"

B89130
12 cm - 4 ³/₄"

PINCE COURBE
CURVED FORCEPS
PINZA CURVA



A griffes
With teeth
Con dientes

Sans griffes
Without teeth
Sin dientes

B89120
12 cm - 4 ³/₄"

B89110
12 cm - 4 ³/₄"



LERICHE

PINCE DROITE
STRAIGHT FORCEPS
PINZA RECTA



A griffes
With teeth
Con dientes

Sans griffes
Without teeth
Sin dientes

B89180
15 cm - 6"

B89170
15 cm - 6"

PINCE COURBE
CURVED FORCEPS
PINZA CURVA



A griffes
With teeth
Con dientes

Sans griffes
Without teeth
Sin dientes

B89160
15 cm - 6"

B89150
15 cm - 6"



PINCE À PANSEMENT
DRESSING FORCEPS
PINZA PARA VENDAJES

Droite
Straight
Recta



B89090
26 cm - 10^{1/4}"

Courbe
Curved
Curva



B89095
26 cm - 10^{1/4}"

BACKHAUS

PINCE À CHAMPS
TOWEL FORCEPS
PINZA PARA CAMPOS



B89100
13 cm - 5"

PINCE À ONGLES
NAIL CUTTERS
PINZA PARA UÑAS



B891900
14 cm - 5^{1/2}"

PRESE TUBE
PINCHOC CLAMPS
CIERRA TUBOS

14 cm - 5^{1/2}"
18 cm - 7"

B892000 
B892010



B892000
14 cm - 5^{1/2}"

SEUTIN

Droite
Straight
Recta



J76050
23 cm - 9"

Double courbure
Double curvature
Doble curvatura



J76060
25 cm - 10"



J76070
21 cm - 8 1/4"

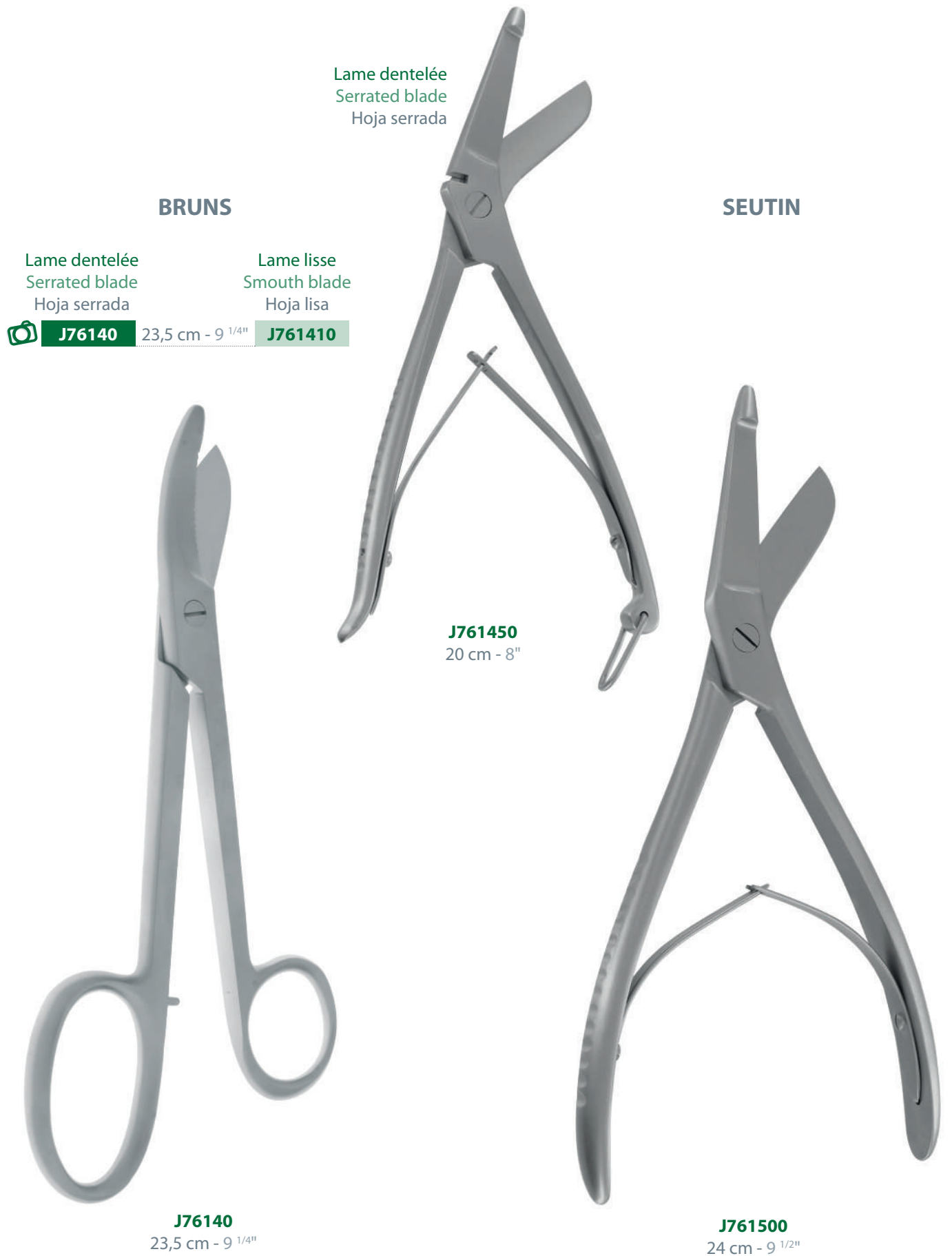

Lame dentelée
Serrated blade
Hoja serrada



J76140

23,5 cm - 9 1/4"

Lame lisse
Smooth blade
Hoja lisa

J761410

Lame dentelée
Serrated blade
Hoja serrada

J761450
20 cm - 8"

SEUTIN

J761500
24 cm - 9 1/2"

J76140
23,5 cm - 9 1/4"

Pince pour plâtres - Plaster forceps - Pinza para escayolas

STILLE

- 23 cm - 9" **J76020** 
- 26 cm - 10 1/4" **J760250**
- 37 cm - 14 1/2" **J76030**

Pour couper
For cutting
Para cortar



J76020
23 cm - 9"

WOLF

- 18 cm - 7" **J76128** 
- 24 cm - 9 1/2" **J76130**



J76128
18 cm - 7"

USA MODEL

Pour écarter
To spread
Para romper



J760310
23 cm - 9"

HENNING

Pour écarter - To spread - Para romper

Sans crémaillère
Without rack
Sin cremallera

17 mm **J76080**

54 mm **J76100**

A crémaillère
With rack
Con cremallera

17 mm **J76090**

54 mm **J76110** 

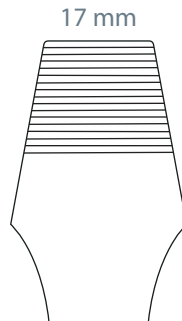

17 mm

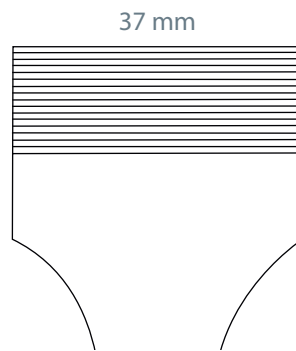

37 mm

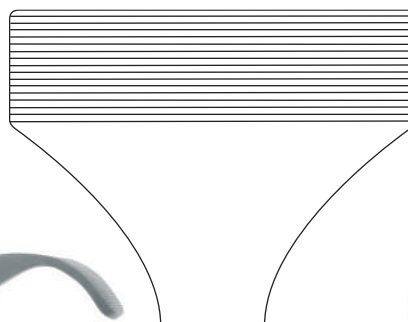

54 mm

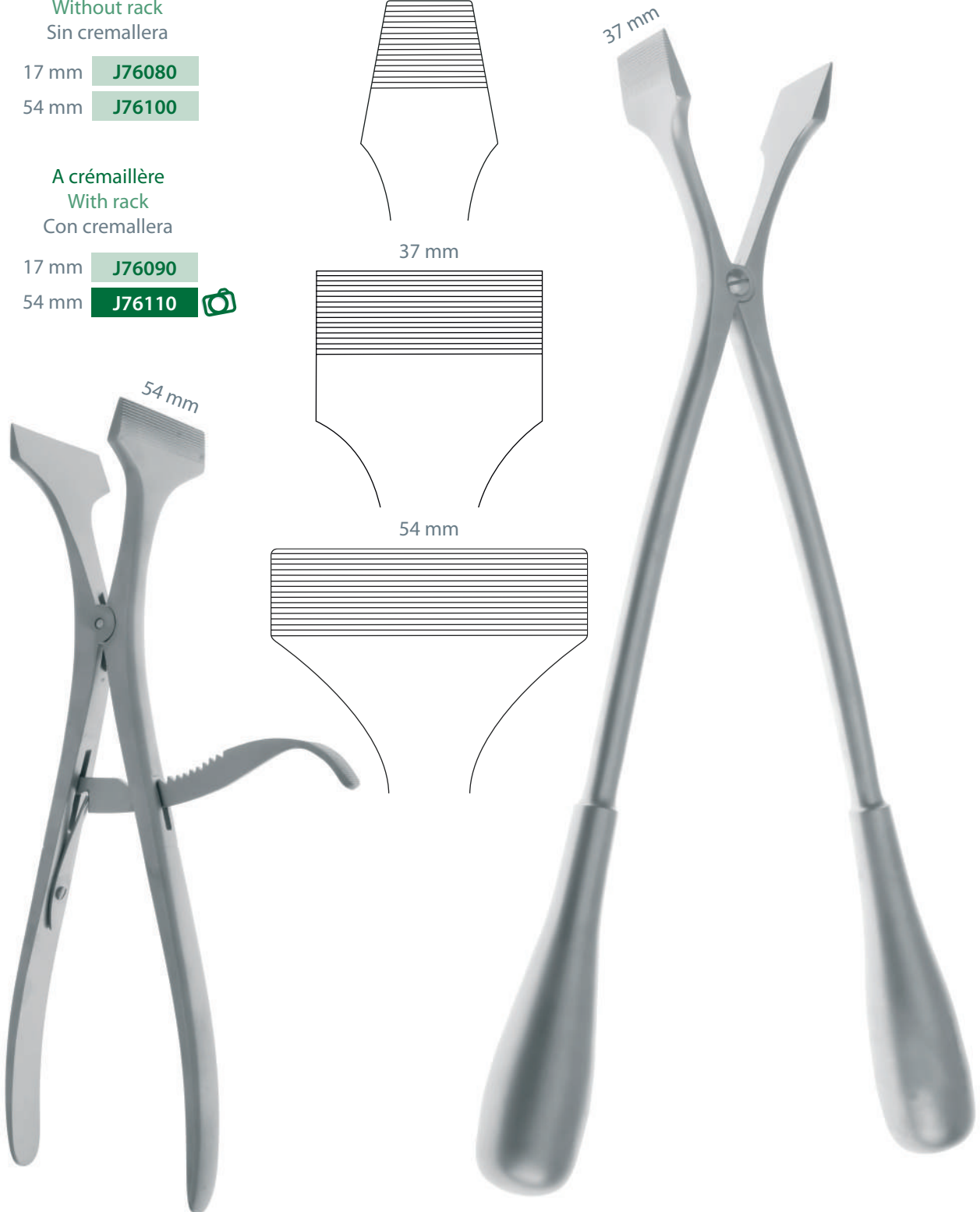

J76110
28 cm - 11"

J76120
40 cm - 15 3/4"

Atelles malléables - Malleables splints - Tablillas maleables



ATELLES MALLÉABLES ALUMINIUM - GARNIES MOUSSE
 MALLEABLES SPLINTS ALUMINIUM - FOAM COVERED
 TABLILLAS MALEABLES DE ALUMINO - ADORNADAS DE ESPUMA



L : 25 cm - l : 15 mm	T90090	
L : 45 cm - l : 20 mm	T90095	
L : 45 cm - l : 25 mm	T90098	
L : 45 cm - l : 30 mm	T90100	
L : 45 cm - l : 40 mm	T90110	
L : 45 cm - l : 50 mm	T90120	
L : 45 cm - l : 60 mm	T90130	
L : 45 cm - l : 70 mm	T90140	
L : 45 cm - l : 80 mm	T90141	
L : 45 cm - l : 90 mm	T90143	
L : 45 cm - l : 100 mm	T90145	

LANDANGER

Canules aspiratrices - Suction tubes - Cánulas aspirantes

SANTY



A90015

26 cm - 10 ¹/₄"

Ø 9 x 6 mm

YANKAUER



A90090

28 cm - 11"

Ø 10 x 6 mm

NUBOER



A902000

21 cm - 8 ¹/₄"

Ø 6 mm

ANDREW PYNCHON



A902010

23 cm - 9"

Ø 6 x 3,4 mm

**AUBERT
(FINSTERER)**



A90300

30 cm - 12"

Ø 15 x 10 mm

BABY POOLE



A903100

20 cm - 8"

Ø 6 mm

POOLE



A903110

22 cm - 8 ³/₄"

Ø 8 mm

POOLE



A903120

22 cm - 8 ³/₄"

Ø 10 mm

LANDANGER

Canules - Cannulas - Cánulas

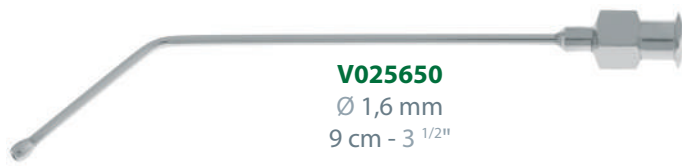

V025650
Ø 1,6 mm
9 cm - 3 1/2"

Canule coudée court n°1
Cannula short angled n°1
Cánula angulada corta n°1

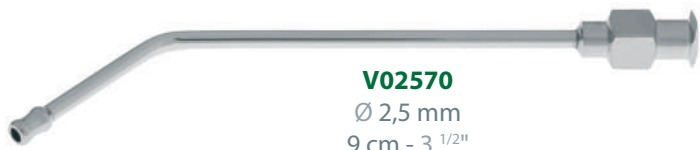

V02570
Ø 2,5 mm
9 cm - 3 1/2"

Canule coudée court n°1
Cannula short angled n°1
Cánula angulada corta n°1

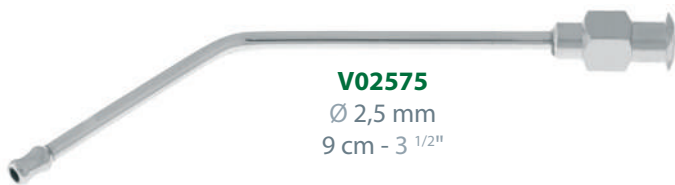

V02575
Ø 2,5 mm
9 cm - 3 1/2"

Canule coudée au milieu n°2
Cannula angled n°2
Cánula angulada n°2



V02580
Ø 2,5 mm
9 cm - 3 1/2"

Canule coudée long n°3
Cannula long angled n°3
Cánula angulada larga n°3

LUER LOCK

Femelle
Female
Hembra



V028000

Mâle
Male
Macho



V028001

Ø 6 mm

MONOD



V02610
22 cm - 8 3/4"

- Ø 7 mm **V02610** 
- Ø 8 mm **V02620**
- Ø 9 mm **V02630**
- Ø 10 mm **V02640**
- Ø 11 mm **V02650**
- Ø 12 mm **V02660**

BORDIER-MEUNIER

TROCART À BIOPSIE OSSEUSE
TROCAR IN OSSEOUS BIOPSY
TROCARE A BIOPSIA ÓSEA

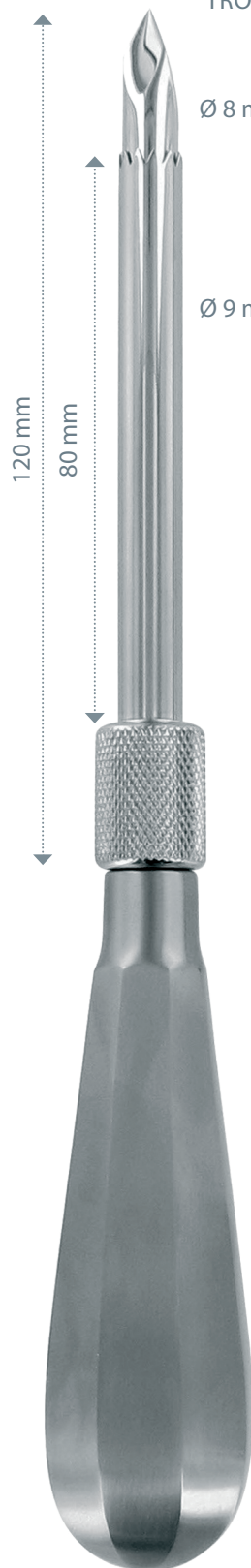

21,5 cm - 8 1/2"

- Ø 8 mm
- Ø 9 mm

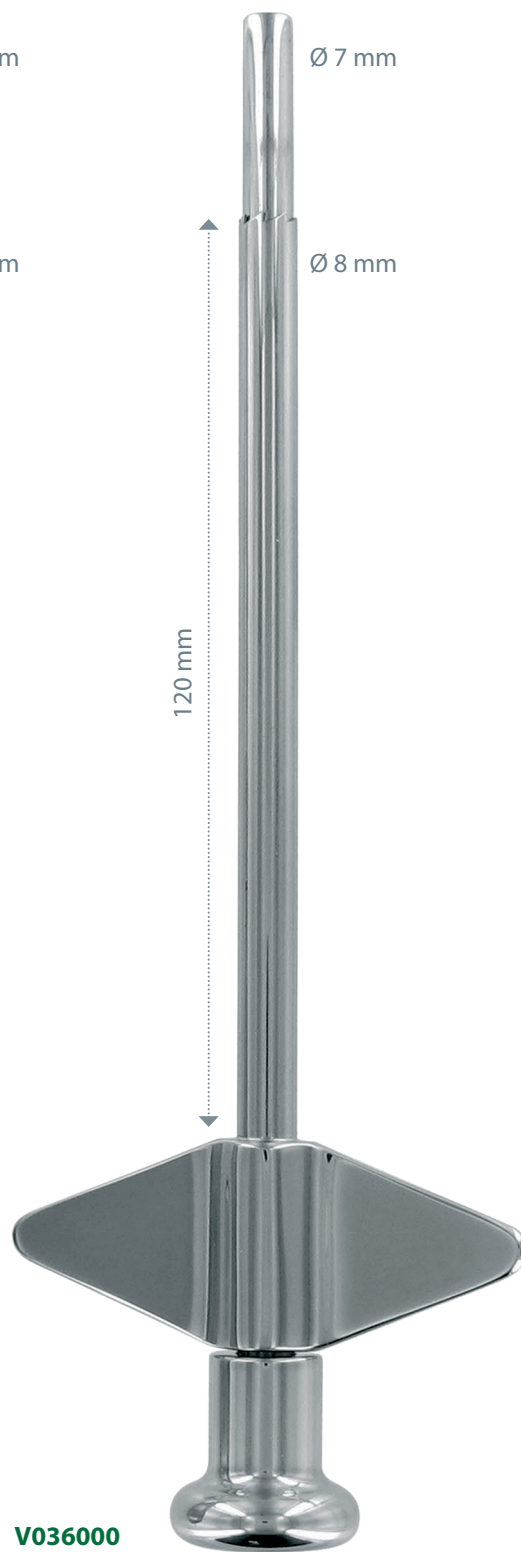

V036000

20,5 cm - 8"

- Ø 7 mm
- Ø 8 mm



Acier chromé
Chrome steel
Acero cromado

STANDARD



V029002
19 cm - 7 1/2"

V029000	Ø 3.0 mm	V029100
V029001	Ø 3.5 mm	V029101
V029002	Ø 4.0 mm	V029102
V029003	Ø 4.5 mm	V029103
V029004	Ø 5.0 mm	
V029005	Ø 5.5 mm	
V029006	Ø 6.0 mm	



V029102
20 cm - 8"

NELSON

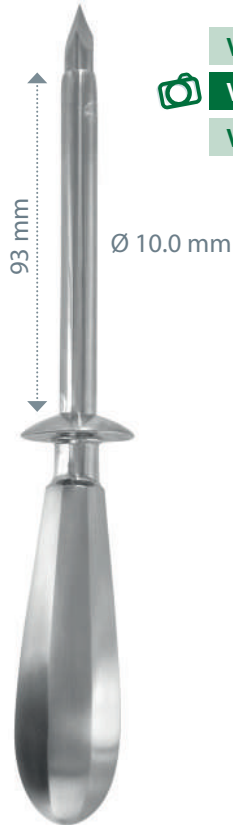

V029451
22 cm - 8 3/4"

V029450	Ø 9.0 mm
V029451	Ø 10.0 mm
V029452	Ø 12.0 mm

UNIVERSAL



V029210
12,5 cm - 5"

V029210	Ø 1.7 - 3.0 - 4.5 - 6.0 mm
V029200	Ø 1.7 - 3.0 - 4.5 mm

Ø 6.0
60 mm
Ø 4.5
55 mm
Ø 3.0
45 mm
Ø 1.7
35 mm

 **Acier chromé**
Chrome steel
Acero cromado

LANDAU

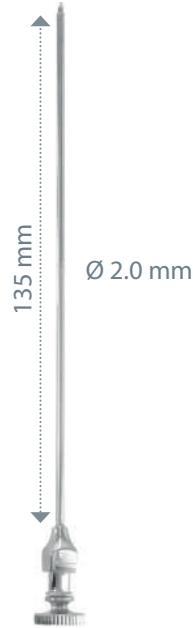

V029300
 16 cm - 6^{1/4}"

PEAN



V029350
 14,5 cm - 5^{3/4}"

BUELAU



V029400
 24 cm - 9^{1/2}"

KRAUSE

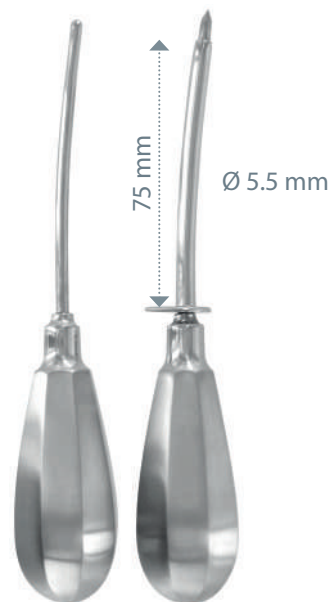

V029500
 16 cm - 6^{1/4}"

LICHTWITZ

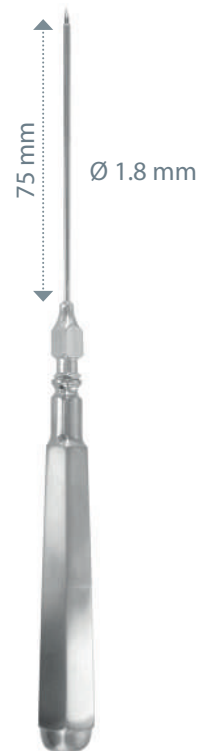

V029550
 20 cm - 8"



ESMARCH

BANDE
BANDAGE
BANDA



A20560
6 cm x 3,50 m

A20570
8 cm x 3,50 m



A20580
10 cm x 3,50 m

SPATULE À POMMADE
OINTMENT SPATULA
ESPÁTULA DE POMADA



A80170
15 cm - 6"



LANDANGER

Matériel divers - Miscellaneous materials - Materiales varios

LORTAT-JACOB

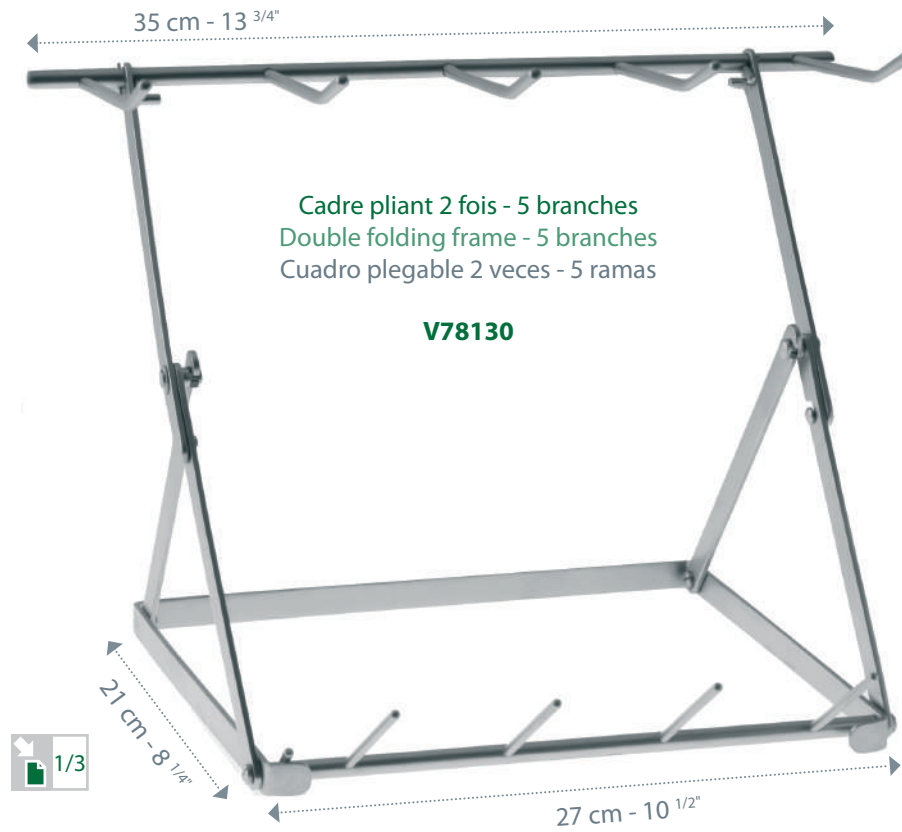

Cadre pliant 2 fois - 5 branches
Double folding frame - 5 branches
Cuadro plegable 2 veces - 5 ramas

V78130

CHEATLE

Pour instruments
For instruments
Para instrumentos



V782000
27 cm - 10 ¹/₂"

MAYO

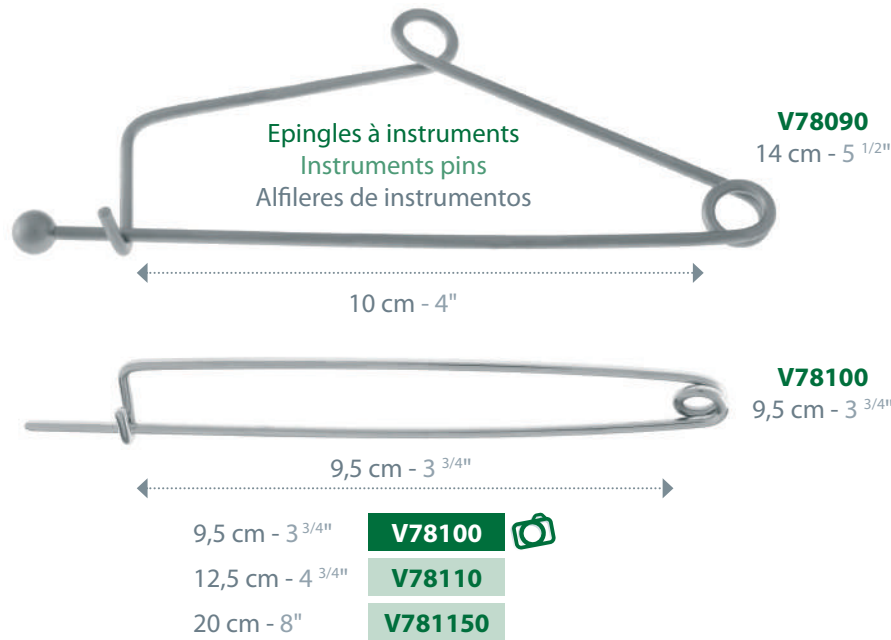

Epingles à instruments
Instruments pins
Alfileres de instrumentos

GUYON-FREUDENBERG

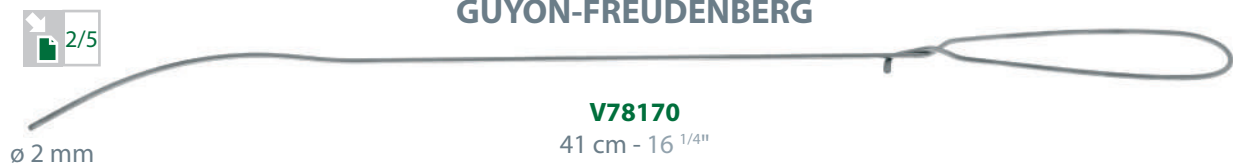

V78170

Matériel divers - Miscellaneous materials - Materiales varios

IP SPRAY POUR LA LUBRIFICATION
IP SPRAY FOR LUBRICATION
IP SPRAY PARA LUBRIFICACIÓN



V78071
400 ml



NETTOYAGE ET RÉNOVATION DES INSTRUMENTS EN INOX
CLEANING AND RENOVATION OF S.S. INSTRUMENTS
LIMPIEZA Y RENOVACIÓN DE LOS INSTRUMENTOS INOX



V78301
1 L

GOMME DE POLISSAGE
POLISH RUBBER
GOMA DE PULIMENTO

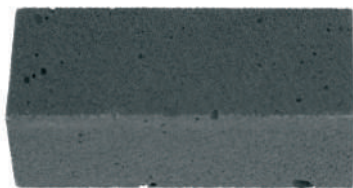

V784000
60 x 25 x 20 mm

SPRAY SILICONÉ
SILICONE SPRAY
SPRAY DE SILICONA



V78321
500 ml



Index numérique - Numerical Index - Índice numérico

Références References Referencias	Chapitre Chapter Capítulo	Page Page Página	Références References Referencias	Chapitre Chapter Capítulo	Page Page Página	Références References Referencias	Chapitre Chapter Capítulo	Page Page Página	Références References Referencias	Chapitre Chapter Capítulo	Page Page Página
A05010	XV	5	A801202	XV	13	B130220	I	4	B25295	III	9
A05020	XV	5	A801203	XV	13	B130230	I	4	B25300	III	9
A05050	XV	5	A801204	XV	13	B130240	I	4	B25302	III	9
A05060	XV	5	A80140	XV	14	B130360	I	4	B25303	III	9
A15160	XV	5	A80150	XV	14	B130710	I	3	B25305	III	10
A20560	XV	31	A80170	XV	31	B132100	I	7	B25310	III	10
A20570	XV	31	A85030	XV	10	B13211P	I	7	B25311	III	10
A20580	XV	31	A85040	XV	10	B132120	I	7	B25312	III	10
A25003	XV	8	A85090	III	88	B132155	I	7	B25315	III	12
A25004	XV	8	A85100	III	88	B132180	I	7	B25320	III	12
A25005	XV	8	A851010	III	88	B132190	I	7	B25325	III	10
A25006	XV	8	A851015	III	88	B132200	I	7	B25330	III	10
A25007	XV	8	A851113	III	88	B132210	I	7	B25335	III	10
A25008	XV	8	A851115	III	88	B132220	I	7	B25340	III	10
A25009	XV	8	A85160	XV	11	B132230	I	7	B25345	III	10
A25010	XV	8	A85170	XV	11	B132240	I	7	B253470	III	10
A25011	XV	8	A851800	XV	11	B132700	I	7	B25350	III	10
A300020	XV	7	A851810	XV	11	B134100	I	7	B253520	III	10
A300030	XV	7	A851820	XV	11	B13411P	I	7	B25355	III	11
A300040	XV	7	A86010	XV	10	B134120	I	7	B25360	III	11
A300050	XV	7	A86020	XV	10	B134155	I	7	B25365	III	11
A30010	XV	6	A860300	XV	10	B134180	I	7	B253680	III	12
A30020	XV	6	A86060	XV	10	B134190	I	7	B25370	III	11
A300300	XV	6	A90015	XV	26	B134200	I	7	B253730	III	12
A300310	XV	6	A90090	XV	26	B134210	I	7	B25375	III	11
A300350	XV	6	A902000	XV	26	B134220	I	7	B25380	III	11
A30060	XV	9	A902010	XV	26	B134230	I	7	B25385	III	11
A30070	XV	9	A90300	XV	26	B134240	I	7	B25390	III	11
A30075	XV	9	A903100	XV	26	B160010	I	6	B25395	III	11
A30090	XV	9	A903110	XV	26	B160013	I	6	B253970	III	11
A30095	XV	9	A903120	XV	26	B160015	I	6	B25400	III	11
A80010	XV	12	B05033	I	2	B160020	I	6	B254010	III	11
A800110	XV	12	B05060	I	2	B160021	I	6	B254012	III	45
A800151	XV	12	B05070	I	2	B160025	I	6	B254013	III	45
A800152	XV	12	B05090	I	2	B160080	I	6	B254014	III	45
A800153	XV	12	B05103	I	2	B161064	I	6	B254015	III	45
A800154	XV	12	B05104	I	2	B161065	I	6	B25402	III	13
A800155	XV	12	B110070	I	3	B161067	I	6	B254021	III	13
A80020	XV	12	B11013	I	3	B161069	I	6	B254022	III	13
A800201	XV	12	B11014	I	4	B20010	I	8	B25403	III	13
A800202	XV	12	B12000	I	3	B20015	I	9	B254031	III	13
A800203	XV	12	B12000G	I	3	B20020	I	9	B254032	III	13
A800204	XV	12	B12001	I	4	B20025	I	9	B25405	III	13
A80030	XV	12	B12001G	I	4	B20030	I	8	B254051	III	13
A80040	XV	12	B12008	I	3	B20040	I	8	B254052	III	13
A800410	XV	12	B12009	I	4	B20045	I	9	B25410	III	13
A800420	XV	12	B123000	I	5	B20050	I	9	B254101	III	13
A80050	XV	14	B123001	I	5	B20060	I	9	B254102	III	13
A80070	XV	13	B123002	I	5	B25260	III	9	B25415	III	15
A80080	XV	13	B130100	I	3	B25261	III	9	B25418	III	15
A80090	XV	13	B13011P	I	3	B25262	III	9	B25421	III	15
A800910	XV	13	B130120	I	3	B25265	III	12	B254220	III	15
A800920	XV	13	B130155	I	3	B25270	III	12	B25426	III	15
A80100	XV	13	B130180	I	4	B25275	III	9	B25460	III	18
A801100	XV	13	B130190	I	4	B25280	III	9	B25465	III	18
A801110	XV	13	B130200	I	4	B25285	III	9	B25470	III	18
A801201	XV	13	B130210	I	4	B25290	III	9	B25475	III	18

Index numérique - Numerical Index - Índice numérico

Références References Referencias	Chapitre Chapter Capítulo	Page Page Página	Références References Referencias	Chapitre Chapter Capítulo	Page Page Página	Références References Referencias	Chapitre Chapter Capítulo	Page Page Página	Références References Referencias	Chapitre Chapter Capítulo	Page Page Página
B25480	III	18	B256301	III	23	B25715	III	25	B258044	III	33
B25483	III	16	B256302	III	23	B25716	III	25	B258045	III	33
B25483L	III	16	B256305	III	24	B25717	III	26	B258047	III	34
B25485	III	16	B25630L	III	22	B25725	III	25	B258048	III	34
B25485L	III	16	B25635	III	22	B25726	III	25	B258049	III	34
B25486	III	16	B256351	III	23	B25727	III	26	B25806	III	32
B25486L	III	16	B256352	III	23	B257300	III	29	B258063	III	33
B25489	III	16	B256355	III	24	B257340	III	30	B258064	III	33
B254891	III	16	B25635L	III	22	B257350	III	29	B258065	III	33
B254892	III	16	B25640	III	22	B257360	III	29	B258067	III	34
B254893	III	16	B256401	III	23	B25737	III	29	B258068	III	34
B254894	III	16	B256402	III	23	B25740	III	29	B258069	III	34
B25489L	III	16	B256405	III	24	B25745	III	29	B258107	III	34
B25490	III	17	B25645	III	22	B257460	III	30	B258108	III	34
B25490L	III	17	B256451	III	23	B257462	III	30	B258109	III	34
B25495	III	17	B256452	III	23	B257465	III	30	B25812	III	32
B25495L	III	17	B256455	III	24	B257470	III	80	B258121	III	35
B25497	III	17	B25650	III	22	B257471	III	80	B258123	III	35
B25497L	III	17	B256501	III	23	B257500	III	80	B258125	III	34
B25498	III	17	B256502	III	23	B257540	III	81	B258128	III	34
B254981	III	17	B256505	III	24	B257550	III	81	B258129	III	34
B254982	III	17	B25655	III	22	B25760	III	81	B25813	III	35
B254983	III	17	B256551	III	23	B257602	III	81	B25814	III	35
B25498L	III	17	B256552	III	23	B257605	III	27	B258150	III	36
B255100	III	16	B256555	III	24	B257609	III	27	B258155	III	36
B255101	III	16	B25660	III	22	B257610	III	27	B25816	III	38
B25572	III	19	B256601	III	23	B257614	III	27	B258161	III	38
B25574	III	19	B256602	III	23	B257615	III	27	B258162	III	38
B25576	III	19	B256605	III	24	B257618	III	85	B25817	III	38
B25578	III	19	B25665	III	22	B257640	III	28	B258171	III	38
B255800	III	19	B256651	III	23	B257641	III	28	B258172	III	38
B255801	III	19	B256652	III	23	B257642	III	28	B258175	III	38
B25600	III	19	B256655	III	24	B257645	III	28	B258176	III	38
B25605	III	19	B25670	III	22	B257650	III	28	B258180	III	38
B256070	III	21	B256701	III	23	B257651	III	28	B258181	III	38
B256071	III	21	B256702	III	23	B257660	III	28	B258182	III	38
B256080	III	21	B25675	III	22	B257661	III	28	B258183	III	38
B256081	III	21	B256751	III	23	B257695	III	28	B258184	III	38
B256090	III	21	B256752	III	23	B25770	III	28	B258185	III	38
B256091	III	21	B256760	III	24	B25775	III	27	B25820	III	36
B25610	III	22	B256770	III	24	B25780	III	31	B25825	III	41
B25610L	III	22		VIII	95	B25786	III	31	B25830	III	41
B25615	III	22	B25680	III	22	B25795	VI	24	B25835	III	41
B25615L	III	22	B256801	III	23	B25800	VI	24	B25840	III	41
B25620	III	22	B256802	III	23	B258010	III	36	B258405	III	42
B256201	III	23	B25685	III	22	B258014	III	36	B258410	III	42
B256202	III	23	B256851	III	23	B258015	III	36	B258415	III	42
B256205	III	24	B256852	III	23	B258016	III	36	B258445	III	31
B25620L	III	22	B25686	III	20	B25802	III	32	B25845	III	31
B256215	III	24	B25688	III	20	B258023	III	33	B258451	III	31
B25625	III	22	B25692	III	20	B258024	III	33	B258460	III	31
B256251	III	23	B25694	III	20	B258025	III	33	B258465	III	31
B256252	III	23	B25696	III	20	B258027	III	34	B258468	III	48
B256255	III	24	B25700	III	20	B258028	III	34	B258469	III	48
B25625L	III	22	B25705	III	25	B258029	III	34	B25847	III	48
B256265	III	24	B25706	III	25	B25804	III	32	B258478	III	48
B25630	III	22	B25707	III	26	B258043	III	33	B258479	III	48

Index numérique - Numerical Index - Índice numérico

Références References Referencias	Chapitre Chapter Capítulo	Page Page Página	Références References Referencias	Chapitre Chapter Capítulo	Page Page Página	Références References Referencias	Chapitre Chapter Capítulo	Page Page Página	Références References Referencias	Chapitre Chapter Capítulo	Page Page Página
B25848	III	48	B259330	III	51	B350090	III	60	B351405B	III	62
B258481	III	37	B259340	III	51	B350095	III	61	B35150	III	62
B258483	III	37	B25935	III	51	B350095SB	III	61	B35160	III	62
B258485	III	37	B259610	III	14	B35010	III	60	B35160M	III	62
B258487	III	37	B259611	III	14	B35020	III	61	B35160SB	III	62
B258489	III	37	B259620	III	14	B35030	III	60	B35172	III	62
B258490	III	37	B259621	III	14	B35030M	III	60	B35174	III	62
B258491	III	37	B259630	III	14	B35040	III	61	B35174M	III	62
B258495	III	46	B259631	III	14	B35040M	III	61	B35174SB	III	62
B258499	III	46	B259640	III	14	B35042	III	59	B351750	III	62
B25850	III	46	B259641	III	14	B35043	III	59	B351751	III	62
B258509	III	46	B259650	III	14	B35044	III	59	B351780	III	62
B25851	III	46	B259651	III	14	B35044M	III	59	B351781	III	62
B25852	III	47	B259660	III	14	B35045	III	59	B35180	III	67
B25853	III	47	B259661	III	14	B35045M	III	59	B35190	III	67
B258531	III	47	B259670	III	14	B35045SB	III	59	B35200	III	67
B258532	III	47	B259671	III	14	B35046	III	59	B35210	III	67
B258537	III	48	B259730	III	49	B35047	III	59	B35220	III	67
B258538	III	48	B259731	III	49	B35047SB	III	59	B35228	III	65
B25854	III	51	B259740	III	49	B35048	III	63	B35230	III	65
B25855	III	51	B259741	III	49	B350482	III	63	B35232	III	65
B25856	III	43	B259750	III	49	B35049	III	64	B35234	III	65
B258561	III	43	B259751	III	49	B350492	III	64	B35240	III	62
B258562	III	43	B259800	III	39	B35049SB	III	64	B35250	III	62
B25857	III	43	B259801	III	39	B35050	III	63	B352580	III	66
B258571	III	43	B259810	III	39	B350502	III	63	B352581	III	66
B258572	III	43	B259811	III	39	B35060	III	64	B35260	III	65
B25858	III	43	B259820	III	39	B350602	III	64	B35260SB	III	65
B25859	III	43	B259830	III	39	B35060SB	III	64	B35270	III	66
B258590	III	44	B259831	III	39	B35070	III	63	B35280	III	66
B258591	III	44	B259840	III	39	B350702	III	63	B353000	III	57
B258595	III	44	B259841	III	39	B35080	III	64	B353005	III	57
B258596	III	44	B259850	III	39	B350802	III	64	B353015	III	57
B258597	III	45	B259851	III	39	B350805B	III	64	B354025	III	69
B258598	III	45	B259860	III	40	B35090	III	63	B354045	III	69
B258599	III	45	B259865	III	40	B350902	III	63	B354060	III	69
B25860	III	53	B259870	III	40	B35100	III	64	B354125	III	69
B25865	III	53	B259900	III	40	B351002	III	64	B354145	III	69
B25870	III	54	B259901	III	40	B351005B	III	64	B354160	III	69
B25875	III	54	B259910	III	40	B351010	III	63	B355000	III	84
B25880	III	54	B259911	III	40	B351011	III	64	B355010	III	84
B25890	III	55	B259915	III	40	B351011SB	III	64	B40005	II	5
B25900	III	55	B35001	III	57	B351020	III	63	B40010	II	5
B259040	III	56	B35001M	III	57	B351021	III	64	B40015	II	5
B259041	III	56	B35002	III	57	B351021SB	III	64	B40020	II	5
B259042	III	56	B35002M	III	57	B35104	III	62	B40021	II	7
B259043	III	56	B35002SB	III	57	B35104M	III	62	B40025	II	5
B259044	III	56	B35003	III	58	B35106	III	62	B40026	II	7
B25905	III	56	B350031	III	58	B35106M	III	62	B40030	II	5
B259051	III	56	B35004	III	58	B35106SB	III	62	B40031	II	7
B259052	III	56	B350041	III	58	B35110	III	62	B40035	II	5
B259053	III	56	B35005	III	58	B35120	III	62	B40040	II	5
B259054	III	56	B35006	III	58	B35120M	III	62	B40045	II	5
B259100	III	87	B35007	III	60	B351205B	III	62	B40050	II	5
B25920	III	50	B35008	III	61	B35130	III	62	B40055	II	5
B25925	III	50	B35008M	III	61	B35140	III	62	B40060	II	5
B25930	III	50	B35008SB	III	61	B35140M	III	62	B40061	II	7

Index numérique - Numerical Index - Índice numérico

Références References Referencias	Chapitre Chapter Capítulo	Page Page Página	Références References Referencias	Chapitre Chapter Capítulo	Page Page Página	Références References Referencias	Chapitre Chapter Capítulo	Page Page Página	Références References Referencias	Chapitre Chapter Capítulo	Page Page Página
B40065	II	5	B401432	II	9	B40246	II	14	B404020	II	25
B40066	II	7	B401433	II	10	B40248	II	14	B404021	II	25
B40070	II	5	B401434	II	9	B40249	II	14	B404022	II	25
B40071	II	7	B401435	II	10	B402491	II	14	B40404	II	30
B40075	II	5	B40145	II	9	B40250	II	17	B404041	II	30
B40080	II	5	B401470	II	10	B40255	II	17	B40406	II	30
B40090	II	6	B40150	II	9	B40260	II	17	B404061	II	30
B400901	II	6	B401520	II	10	B40265	II	17	B404090	II	27
B400902	II	6	B40155	II	9	B402655	II	17	B404091	II	27
B40092	II	6	B40157	II	10	B402656	II	17	B404100	II	27
B40095	II	6	B40160	II	9	B402657	II	17	B404101	II	27
B400951	II	6	B401620	II	10	B402660	II	17	B404110	II	28
B400952	II	6	B40165	II	9	B40270	II	19	B404111	II	28
B40100	II	6	B401670	II	10	B40275	II	19	B404120	II	28
B40105	II	6	B401680	II	9	B40280	II	18	B404121	II	28
B40110	II	8	B401681	II	10	B40285	II	18	B40415	II	19
B401111	II	8	B401682	II	9	B40290	II	18	B40420	II	19
B401112	II	8	B401683	II	10	B40295	II	18	B40425	II	19
B401113	II	8	B401684	II	9	B40300	II	18	B404251	II	19
B401114	II	8	B401685	II	10	B403040	II	18	B404349	II	20
B401115	II	8	B401698	II	11	B40305	II	18	B40435	II	20
B401120	II	8	B401699	II	11	B40310	II	18	B404360	II	20
B401121	II	8	B40170	II	11	B40315	II	18	B40440	II	22
B401122	II	8	B401710	II	11	B40325	II	20	B404430	II	22
B401123	II	8	B401711	II	11	B40330	II	20	B404440	II	22
B401124	II	8	B401748	II	11	B403305	II	20	B404441	II	22
B401125	II	8	B401749	II	11	B40335	II	20	B40445	II	22
B401130	II	8	B40175	II	11	B40340	II	20	B404450	II	22
B401131	II	8	B401760	II	11	B403405	II	20	B404451	II	22
B401132	II	8	B401761	II	11	B40345	II	20	B404453	II	22
B401133	II	8	B401800	II	13	B40350	II	20	B404454	II	22
B401134	II	8	B401801	II	13	B40355	II	21	B404456	II	24
B401135	II	8	B401810	II	13	B40360	II	21	B404457	II	24
B401140	II	5	B401811	II	13	B40365	II	21	B404458	II	23
B401141	II	5	B401820	II	12	B403655	II	21	B404459	II	23
B401142	II	5	B401821	II	12	B403660	II	21	B40446	II	23
B401143	II	5	B401830	II	12	B403670	II	21	B40447	II	23
B401144	II	5	B401831	II	12	B403680	II	21	B404470	II	23
B401145	II	5	B401840	II	12	B403690	II	21	B404471	II	23
B401150	II	5	B401841	II	12	B40374	II	16	B404475	II	24
B401151	II	5	B40200	II	13	B40375	II	16	B40448	II	22
B401152	II	5	B40205	II	13	B40380	II	16	B404490	II	22
B401153	II	5	B40210	II	13	B40385	II	16	B404495	II	24
B401154	II	5	B40215	II	13	B40390	II	16	B404496	II	24
B401155	II	5	B402151	II	13	B403950	II	16	B40600	II	47
B40120	II	9	B402152	II	13	B403952	II	29	B406001	II	47
B401220	II	10	B402200	II	15	B403953	II	29	B406010	II	47
B40125	II	9	B402201	II	15	B403954	II	29	B406011	II	47
B401270	II	10	B402202	II	15	B403955	II	29	B406020	II	47
B40130	II	9	B402203	II	15	B403959	II	16	B406021	II	47
B40132	II	10	B40225	II	14	B403960	II	16	B40610	II	45
B40135	II	9	B40230	II	14	B403961	II	16	B40620	II	45
B401370	II	10	B40235	II	14	B403962	II	16	B40640	II	45
B40140	II	9	B40240	II	14	B403963	II	16	B40650	II	45
B401420	II	10	B40245	II	14	B40400	II	25	B40660	II	45
B401430	II	9	B402451	II	14	B404005	II	25	B40670	II	45
B401431	II	10	B402455	II	14	B404010	II	31	B406810	II	45

Index numérique - Numerical Index - Índice numérico

Références References Referencias	Chapitre Chapter Capítulo	Page Page Página	Références References Referencias	Chapitre Chapter Capítulo	Page Page Página	Références References Referencias	Chapitre Chapter Capítulo	Page Page Página	Références References Referencias	Chapitre Chapter Capítulo	Page Page Página
B406811	II	45	B408611	II	31	B50257	IV	11	B504591	IV	21
B406812	II	45	B408620	II	31	B50265	IV	11	B504592	IV	21
B406813	II	45	B408621	II	31	B50267	IV	11	B504593	IV	21
B406814	II	45	B408701	II	35	B50272	IV	10	B504594	IV	21
B406815	II	45	B408703	II	35	B50274	IV	10	B504595	IV	21
B406910	II	45	B408704	II	35	B50276	IV	11	B504596	IV	21
B406911	II	45	B408705	II	35	B50278	IV	11	B504597	IV	21
B406912	II	45	B408707	II	35	B50282	IV	27	B504598	IV	22
B406950	II	47	B408801	II	33	B50284	IV	27	B504599	IV	22
B406960	II	47	B408802	II	33	B50286	IV	27	B50465	IV	15
B40750	II	46	B408804	II	33	B50288	IV	27	B504651	IV	18
B407510	II	46	B408810	II	33	B503000	IV	24	B504652	IV	18
B407520	II	46	B408820	II	33	B503001	IV	24	B504653	IV	18
B407550	II	46	B408821	II	33	B503010	IV	24	B504654	IV	18
B40760	II	46	B408830	II	34	B503011	IV	24	B504661	IV	18
B40770	II	46	B408831	II	34	B50330	IV	25	B504662	IV	18
B407750	II	46	B408835	II	34	B50335	IV	25	B504663	IV	18
B40780	II	46	B408836	II	34	B50345	IV	25	B504664	IV	18
B407810	II	26	B408838	II	34	B50350	IV	25	B50555	IV	31
B407811	II	26	B410011	II	51	B50360	IV	25	B50560	IV	31
B407820	II	26	B410021	II	51	B50365	IV	25	B50565	IV	31
B407821	II	26	B410031	II	51	B50375	IV	25	B50570	IV	31
B407830	II	26	B410041	II	51	B50380	IV	25	B50575	IV	31
B407831	II	26	B410101	II	51	B50410	IV	20	B50580	IV	31
B407840	II	26	B410110	II	51	B50415	IV	20	B50585	IV	31
B407841	II	26	B410111	II	51	B50430	IV	19	B50590	IV	31
B407850	II	26	B410120	II	51	B50435	IV	19	B50595	IV	31
B407851	II	26	B410121	II	51	B50440	IV	19	B50600	IV	31
B407860	II	26	B50010	IV	118	B50445	IV	19	B50605	IV	31
B407861	II	26	B50020	IV	118	B50446	IV	20	B50610	IV	31
B407900	II	45	B50025	IV	118	B50447	IV	20	B50615	IV	31
B40800	II	51	B50050	IV	118	B504500	IV	16	B50620	IV	31
B408010	II	35	B50055	IV	118	B504510	IV	16	B50625	IV	31
B408020	II	35	B50070	IV	9	B504520	IV	17	B50630	IV	31
B408030	II	35	B50075	IV	9	B504530	IV	17	B50632	IV	32
B408040	II	51	B50085	IV	9	B504540	IV	36	B50634	IV	32
B40810	II	37	B50200	IV	10	B504545	IV	36	B50660	IV	28
B408110	II	37	B50202	IV	10	B504547	IV	36	B50665	IV	28
B40820	II	37	B50205	IV	10	B504548	IV	36	B50670	IV	28
B408210	II	37	B50207	IV	10	B50455	IV	15	B50675	IV	28
B408250	II	37	B50210	IV	10	B504560	IV	23	B50680	IV	28
B40830	II	36	B50212	IV	10	B504561	IV	23	B50685	IV	28
B40840	II	36	B50215	IV	10	B504562	IV	23	B50690	IV	28
B408500	II	32	B50217	IV	10	B504563	IV	23	B50695	IV	28
B408501	II	32	B50220	IV	10	B504564	IV	23	B506951	IV	29
B408502	II	32	B50225	IV	10	B504565	IV	23	B506952	IV	29
B408510	II	32	B50230	IV	10	B504566	IV	23	B506953	IV	29
B408511	II	32	B50231	IV	10	B504567	IV	23	B506954	IV	29
B408512	II	32	B50235	IV	11	B504580	IV	23	B506955	IV	29
B408515	II	32	B50236	IV	11	B504581	IV	23	B506956	IV	29
B408516	II	32	B50240	IV	11	B504582	IV	23	B506957	IV	29
B408522	II	32	B50242	IV	11	B504583	IV	23	B506958	IV	29
B408526	II	32	B50245	IV	11	B504584	IV	23	B506960	IV	30
B408601	II	31	B50247	IV	11	B504585	IV	23	B506961	IV	30
B408602	II	31	B50250	IV	11	B504586	IV	23	B506962	IV	30
B408603	II	31	B50252	IV	11	B504587	IV	23	B506963	IV	30
B408610	II	31	B50255	IV	11	B504590	IV	21	B506966	IV	30

Index numérique - Numerical Index - Índice numérico

Références Referencias Referencias	Chapitre Chapter Capítulo	Page Page Página	Références Referencias Referencias	Chapitre Chapter Capítulo	Page Page Página	Références Referencias Referencias	Chapitre Chapter Capítulo	Page Page Página	Références Referencias Referencias	Chapitre Chapter Capítulo	Page Page Página
B506967	IV	30	B50793	IV	122	B602902	IV	40	B60540	IV	51
B506968	IV	30	B50794	IV	122	B602904	IV	40	B60545	IV	51
B506969	IV	30	B507950	IV	126	B602906	IV	40	B60550	IV	51
B506990	IV	12	B507955	IV	126	B602908	IV	40	B60560	IV	51
B50700	IV	12	B507960	IV	126	B602910	IV	40	B60570	IV	51
B50705	IV	12	B507970	IV	126	B602912	IV	40	B60580	IV	51
B50706	IV	12	B507975	IV	126	B602914	IV	40	B60590	IV	51
B507065	IV	12	B507980	IV	127	B60330	IV	42	B60600	IV	51
B50707	IV	12	B507981	IV	127	B60340	IV	42	B60601	IV	51
B507080	IV	12	B507990	IV	127	B60350	IV	42	B60602	IV	51
B507081	IV	12	B507991	IV	127	B60360	IV	42	B60603	IV	51
B507090	IV	12	B508000	IV	44	B603650	IV	100	B60604	IV	51
B50710	IV	12	B508001	IV	44	B60370	IV	100	B60605	IV	51
B50715	IV	12	B508002	IV	44	B603800	IV	100	B60606	IV	51
B50720	IV	12	B508003	IV	44	B60390	IV	100	B60607	IV	51
B507210	IV	12	B50805	IV	98	B603950	IV	100	B60608	IV	51
B50725	IV	12	B508090	IV	109	B60400	IV	101	B606090	VIII	95
B507261	IV	12	B508095	IV	109	B60420	IV	101	B60610	IV	52
B507262	IV	12	B50810	IV	109	B60422	IV	100	B60615	IV	52
B507295	IV	13	B50815	IV	109	B60424	IV	100	B60620	IV	52
B50730	IV	13	B50830	II	52	B604390	IV	43	B60630	IV	52
B50735	IV	13	B508310	II	52	B60440	IV	43	B60640	IV	52
B507351	IV	13	B508311	II	52	B60450	IV	38	B60650	IV	52
B507352	IV	13	B50835	IX	9	B60460	IV	38	B60660	IV	52
B507353	IV	13	B508400	IV	26	B60470	IV	38	B60670	IV	52
B507354	IV	13	B508401	IV	26	B60480	IV	38	B60700	IV	53
B507355	IV	13	B508450	IV	26	B604810	IV	38	B60710	IV	52
B507395	IV	13	B508451	IV	26	B604960	IV	60	B60715	IV	52
B50740	IV	13	B508455	IV	26	B604970	IV	60	B60720	IV	52
B50745	IV	13	B55260	IV	46	B604971	IV	60	B60730	IV	52
B507451	IV	13	B55280	IV	46	B604980	IV	60	B60740	IV	52
B507452	IV	13	B55300	IV	47	B604981	IV	60	B60750	IV	52
B507453	IV	13	B55310	IV	47	B604982	IV	60	B60752	IV	52
B507454	IV	13	B554000	IX	8	B604990	IV	58	B60753	IV	52
B507455	IV	13	B554005	IX	8	B605000	IV	55	B60756	IV	53
B50746	IV	14	B554010	IX	8	B605001	IV	55	B607569	IV	61
B50747	IV	14	B554015	IX	8	B605002	IV	55	B607570	IV	61
B50748	IV	14	B554020	IX	8	B605003	IV	55	B607571	IV	61
B50749	IV	14	B554025	IX	8	B605004	IV	55	B607572	IV	67
B50750	IV	33	B554100	IX	9	B605005	IV	55	B607574	IV	67
B50755	IV	33	B554200	IX	10	B605006	IV	55	B60770	IV	45
B50760	IV	33	B554201	IX	10	B605007	IV	55	B60790	IV	45
B50765	IV	33	B554210	IX	10	B605008	IV	55	B607901	IV	45
B507660	IV	48	B554211	IX	10	B605009	IV	61	B607902	IV	45
B507662	IV	48	B60140	IV	39	B605250	IV	57	B60810	IV	64
B50767	IV	48	B60150	IV	39	B605251	IV	57	B60820	IV	64
B507680	IV	49	B60160	IV	39	B605252	IV	57	B60860	IV	65
B507690	IV	49	B60180	IV	39	B605253	IV	57	B60870	IV	65
B507695	IV	49	B60190	IV	39	B605254	IV	57	B60880	IV	81
B507701	IV	120	B60200	IV	39	B605255	IV	57	B60885	IV	81
B507702	IV	120	B60220	IV	39	B605256	IV	57	B60890	IV	81
B50780	IV	120	B60230	IV	39	B605257	IV	57	B60891	IV	66
B50785	IV	120	B60240	IV	39	B605258	IV	57	B60892	IV	66
B507900	IV	121	B60260	IV	39	B605259	IV	57	B60893	IV	66
B507901	IV	121	B60270	IV	39	B605300	IV	50	B60894	IV	53
B507910	IV	121	B60280	IV	39	B605301	IV	50	B60895	IV	53
B507911	IV	121	B602900	IV	40	B60535	IV	50	B60896	IV	69

Index numérique - Numerical Index - Índice numérico

Références References Referencias	Chapitre Chapter Capítulo	Page Page Página	Références References Referencias	Chapitre Chapter Capítulo	Page Page Página	Références References Referencias	Chapitre Chapter Capítulo	Page Page Página	Références References Referencias	Chapitre Chapter Capítulo	Page Page Página
B60897	IV	69	B613112	IV	63	B65240	IV	86	B80095	VII	42
B609000	IV	56	B613114	IV	63	B65250	IV	86	B80100	VII	42
B609001	IV	56	B613120	IV	63	B65290	IV	88	B80105	VII	42
B609095	IV	34	B613130	IV	59	B65310	IV	88	B80110	VII	42
B609096	IV	34	B616113	IV	63	B65330	IV	93	B80115	VII	42
B609097	IV	34	B640000	IV	67	B65335	IV	93	B80117	VII	31
B609100	IV	35	B640009	IV	82	B65370	IV	93	B80120	VII	31
B609101	IV	35	B640010	IV	82	B65420	IV	93	B80125	VII	31
B609102	IV	35	B640015	IV	82	B65430	IV	93	B801255	VII	31
B609103	IV	35	B640016	IV	82	B65440	IV	93	B80130	VII	31
B609104	IV	56	B640020	IV	82	B654600	IV	95	B80135	VII	31
B609105	IV	56	B640031	IV	83	B654610	IV	95	B801351	VII	31
B609106	IV	56	B640032	IV	83	B654620	IV	95	B801352	VII	31
B609108	IV	37	B640033	IV	83	B654630	IV	96	B801353	VII	31
B609109	IV	37	B640034	IV	83	B654640	IV	96	B801354	VII	31
B609110	IV	41	B641000	IV	77	B654650	IV	97	B801356	VII	31
B609111	IV	41	B641100	IV	80	B654660	IV	97	B801358	VII	31
B609112	IV	35	B641105	IV	80	B65470	IV	94	B801359	VII	31
B609113	IV	35	B641110	IV	80	B65480	IV	94	B80136	VII	33
B609115	IV	41	B641115	IV	80	B65490	IV	94	B801363	VII	33
B609116	IV	41	B641120	IV	80	B654905	IV	94	B801364	VII	37
B609122	IV	43	B65030	IV	69	B65495	IV	94	B801365	VII	37
B609123	IV	43	B65040	IV	69	B65500	IV	94	B801366	VII	37
B609125	IV	58	B65070	IV	68	B655010	IV	94	B801367	VII	37
B609126	IV	58	B65080	IV	68	B655020	IV	94	B801368	VII	37
B609127	IV	58	B650900	IV	68	B65515	IV	98	B80137	VII	33
B609129	IV	58	B651000	IV	68	B655200	IV	99	B801375	VII	37
B609130	IV	58	B65113	IV	85	B65530	IV	99	B801376	VII	37
B609135	IV	58	B65119	IV	85	B655340	IV	102	B80140	VII	36
B609140	IV	58	B651200	IV	85	B655360	IV	102	B801422	VII	33
B609150	IV	59	B65123	IV	85	B655365	IV	92	B801451	VII	34
B609151	IV	59	B65125	IV	85	B655370	IV	92	B801452	VII	34
B609152	IV	59	B65126	IV	85	B656025	IV	92	B801453	VII	34
B609155	IV	59	B651265	IV	85	B70070	IV	103	B801455	VII	34
B609160	IV	59	B65127	IV	87	B70100	IV	103	B801456	VII	34
B612100	IV	54	B651280	IV	88	B70130	IV	104	B801457	VII	34
B612110	IV	54	B65129	IV	87	B70140	IV	104	B801458	VII	35
B612120	IV	54	B65131	IV	87	B70150	IV	104	B801459	VII	35
B612130	IV	54	B651315	IV	87	B70160	IV	104	B801460	VII	35
B612140	IV	54	B651320	IV	87	B701700	IV	105	B801462	VII	50
B612150	IV	54	B65135	IV	84	B70190	IV	105	B801464	VII	50
B612160	IV	54	B651350	IV	84	B70200	IV	105	B801466	VII	50
B612700	IV	54	B651360	IV	84	B70210	IV	107	B801468	VII	50
B612710	IV	54	B651500	IV	89	B70220	IV	107	B801470	VII	50
B612720	IV	54	B651550	IV	89	B702250	IV	107	B801471	VII	50
B612730	IV	54	B651555	IV	90	B702300	IV	103	B801472	VII	50
B612740	IV	54	B651565	IV	90	B702350	IV	103	B801473	VII	50
B612750	IV	54	B651580	IV	90	B702355	IV	103	B801474	VII	50
B612760	IV	54	B65170	IV	90	B702400	IV	103	B801476	VII	50
B613000	IV	62	B65190	IV	89	B702450	IV	106	B801478	VII	50
B613020	IV	62	B65191	IV	89	B702451	IV	106	B801480	VII	35
B613040	IV	62	B65192	IV	90	B702500	IV	106	B801483	VII	36
B613041	IV	62	B65193	IV	90	B702505	IV	106	B801484	VII	36
B613080	IV	62	B65210	IV	91	B80081	VII	16	B801485	VII	36
B613100	IV	62	B652110	IV	91	B80083	VII	16	B801486	VII	36
B613110	IV	63	B65215	IV	91	B80085	VII	42	B801487	VII	36
B613111	IV	63	B65230	IV	86	B80090	VII	42	B801488	VII	36

Index numérique - Numerical Index - Índice numérico

Références References Referencias	Chapitre Chapter Capítulo	Page Page Página	Références References Referencias	Chapitre Chapter Capítulo	Page Page Página	Références References Referencias	Chapitre Chapter Capítulo	Page Page Página	Références References Referencias	Chapitre Chapter Capítulo	Page Page Página
B801490	VII	25	B802719	VII	55	B802872	VII	26	B802943	VII	55
B801491	VII	25	B80272	VII	54	B802873	VII	26	B802944	VII	55
B801492	VII	24	B802721	VII	54	B802874	VII	26	B802945	VII	55
B801493	VII	24	B80273	VII	54	B802875	VII	26	B802946	VII	62
B80150	VII	24	B80274	VII	54	B802876	VII	26	B802947	VII	55
B80151	VII	25	B802740	VII	46	B802877	VII	26	B802948	VII	55
B80155	VII	24	B802741	VII	46	B802878	VII	27	B802949	VII	61
B80156	VII	25	B802742	VII	55	B802880	VII	27	B80295	VII	111
B801570	VII	24	B802743	VII	46	B802881	VII	27	B802951	VII	111
B801575	VII	25	B802744	VII	46	B802883	VII	27	B80300	VII	111
B80160	VII	24	B802745	VII	46	B802885	VII	42	B803001	VII	111
B80161	VII	25	B802747	VII	46	B802886	VII	42	B803005	VII	111
B80165	VII	24	B802748	VII	46	B802887	VII	42	B80301	VII	11
B80166	VII	25	B802749	VII	46	B802888	VII	42	B80302	VII	11
B801670	VII	24	B80275	VII	43	B802889	VII	42	B80303	VII	11
B801675	VII	25	B802750	VII	46	B802890	VII	42	B80304	VII	11
B80170	VII	24	B802751	VII	46	B802891	VII	42	B80306	VII	11
B80171	VII	25	B802755	VII	43	B802892	VII	42	B803062	VII	11
B80175	VII	24	B80276	VII	43	B802893	VII	42	B803064	VII	11
B80176	VII	25	B802765	VII	43	B802894	VII	42	B803070	VII	11
B801770	VII	24	B80277	VII	43	B802896	VII	51	B803071	VII	11
B801775	VII	25	B802770	VII	43	B802897	VII	51	B803072	VII	11
B80190	VII	24	B802771	VII	45	B802898	VII	51	B803073	VII	11
B80191	VII	25	B802772	VII	45	B80290	VII	112	B803074	VII	13
B80195	VII	24	B802774	VII	45	B802901	VII	112	B803075	VII	13
B80196	VII	25	B802776	VII	45	B802905	VII	112	B803076	VII	13
B801970	VII	24	B802777	VII	45	B802910	VII	112	B803077	VII	13
B801975	VII	25	B802778	VII	45	B802912	VII	111	B803078	VII	13
B80210	VII	24	B802779	VII	45	B802913	VII	111	B803079	VII	13
B80211	VII	25	B80278	VII	44	B802914	VII	111	B803080	VII	13
B80215	VII	24	B802785	VII	44	B802915	VII	111	B803081	VII	13
B80216	VII	25	B80279	VII	44	B802917	VII	62	B803082	VII	13
B802175	VII	25	B80280	VII	44	B802918	VII	62	B803083	VII	13
B80218	VII	22	B80281	VII	44	B802919	VII	52	B803084	VII	13
B80219	VII	22	B802815	VII	44	B802920	VII	52	B803085	VII	13
B80220	VII	22	B80282	VII	44	B802921	VII	52	B803086	VII	13
B80225	VII	22	B802825	VII	44	B802922	VII	62	B803087	VII	13
B80240	VII	22	B802826	VII	44	B802923	VII	62	B803090	VII	13
B80245	VII	22	B80283	VII	44	B802924	VII	62	B803091	VII	13
B80266	VII	22	B80285	VII	44	B802925	VII	62	B803092	VII	13
B80267	VII	22	B802852	VII	26	B802926	VII	61	B803093	VII	13
B802671	VII	28	B802853	VII	26	B802927	VII	61	B803094	VII	13
B802672	VII	28	B802854	VII	26	B802928	VII	61	B803095	VII	13
B802673	VII	28	B802855	VII	26	B802929	VII	61	B803101	VII	18
B802674	VII	28	B802856	VII	26	B802930	VII	61	B803102	VII	18
B802675	VII	28	B802860	VII	44	B802931	VII	61	B803103	VII	18
B802679	VII	29	B802861	VII	47	B802932	VII	61	B803104	VII	18
B80268	VII	29	B802862	VII	16	B802933	VII	61	B803105	VII	18
B80269	VII	29	B802863	VII	16	B802934	VII	52	B803106	VII	18
B80270	VII	29	B802864	VII	16	B802935	VII	52	B803108	VII	17
B80271	VII	29	B802865	VII	16	B802936	VII	52	B803109	VII	17
B802711	VII	55	B802866	VII	26	B802937	VII	53	B803110	VII	17
B802712	VII	55	B802867	VII	26	B802938	VII	53	B803112	VII	17
B802714	VII	51	B802868	VII	26	B802939	VII	53	B803113	VII	17
B802715	VII	51	B802869	VII	26	B802940	VII	53	B80312	VII	11
B802716	VII	51	B802870	VII	26	B802941	VII	54	B80314	VII	11
B802717	VII	51	B802871	VII	26	B802942	VII	55	B80316	VII	11

Index numérique - Numerical Index - Índice numérico

Références References Referencias	Chapitre Chapter Capítulo	Page Page Página	Références References Referencias	Chapitre Chapter Capítulo	Page Page Página	Références References Referencias	Chapitre Chapter Capítulo	Page Page Página	Références References Referencias	Chapitre Chapter Capítulo	Page Page Página
B80318	VII	11	B803890	VII	38	B804468	VII	59	B805301	VII	114
B80320	VII	111	B80390	VII	39	B804470	VII	60	B805302	VII	114
B803205	VII	111	B803905	VII	39	B804471	VII	60	B80535	VII	114
B80325	VII	19	B803910	VII	39	B804472	VII	60	B805351	VII	114
B803255	VII	19	B803911	VII	39	B804473	VII	60	B805352	VII	114
B80327	VII	19	B803912	VII	39	B80450	VII	94	B805360	VII	115
B803275	VII	19	B803913	VII	39	B80455	VII	94	B805361	VII	115
B80328	VII	19	B803914	VII	39	B804590	VII	60	B80537	VII	115
B803282	VII	15	B803915	VII	39	B804600	VII	60	B805371	VII	115
B803284	VII	15	B803920	VII	39		VIII	96	B80538	VII	118
B803286	VII	15	B803930	VII	39	B804610	VIII	96	B805390	VII	115
B803290	VII	62	B803931	VII	39	B804620	VIII	96	B805391	VII	115
B80330	VII	19	B803932	VII	39	B804630	VIII	96	B805395	VII	118
B803301	VII	20	B803933	VII	39	B804640	VIII	96	B805396	VII	118
B803302	VII	20	B803934	VII	39	B80470	VII	87	B80540	VII	118
B803303	VII	20	B803935	VII	39	B80475	VII	87	B805401	VII	118
B803305	VII	20	B803936	VII	39	B80476	VII	87	B805410	VII	119
B803306	VII	20	B803937	VII	39	B804770	VII	87	B805412	VII	119
B803307	VII	20	B803938	VII	39	B80482	VII	89	B805413	VII	119
B803310	VII	20	B803939	VII	39	B804822	VII	89	B805415	VII	115
B803311	VII	20	B803940	VII	41	B80483	VII	89	B805419	VII	116
B803312	VII	20	B803941	VII	41	B804832	VII	89	B80542	VII	116
B803320	VII	10	B803942	VII	41	B804835	VII	90	B805420	VII	121
B80335	VII	10	B803990	VII	40	B804837	VII	90	B805421	VII	116
B80336	VII	10	B80400	VII	40	B80484	VII	89	B805422	VII	116
B80337	VII	10	B80410	VII	40	B804842	VII	89	B805423	VII	116
B80338	VII	14	B804105	VII	40	B804850	VII	90	B805425	VII	120
B80340	VII	14	B804110	VII	40	B804852	VII	90	B80543	VII	120
B80341	VII	14	B804120	VII	40	B804854	VII	91	B80544	VII	120
B80342	VII	14	B804150	VII	56	B804855	VII	91	B805445	VII	120
B80348	VII	9	B80420	VII	56	B804856	VII	91	B80545	VII	120
B80349	VII	9	B80422	VII	56	B804857	VII	91	B80546	VII	120
B80350	VII	9	B80425	VII	56	B804858	VII	91	B80548	VII	120
B80351	VII	9	B80427	VII	56	B804859	VII	91	B805495	VII	120
B80353	VII	9	B804280	VII	57	B80486	VII	88	B80550	VII	120
B803533	VII	9	B804285	VII	57	B80488	VII	88	B80551	VII	120
B803535	VII	9	B804308	VII	58	B804900	VII	88	B805530	VII	120
B803537	VII	9	B804310	VII	58	B80494	VII	88	B805535	VII	120
B803540	VII	9	B804312	VII	58	B80496	VII	88	B805550	VII	121
B803541	VII	9	B804320	VII	58	B80498	VII	87, 88	B805551	VII	121
B803543	VII	10	B80435	VII	57	B80500	VII	87, 88	B80556	VII	121
B803545	VII	9	B80440	VII	57	B80502	VII	91	B80561	VII	121
B803550	VII	10	B80442	VII	57	B80505	VII	92	B80566	VII	121
B803551	VII	10	B804422	VII	57	B80507	VII	92	B80568	VII	122
B80360	VII	30	B804424	VII	57	B80509	VII	92	B80570	VII	122
B80365	VII	30	B804426	VII	57	B80511	VII	92	B80573	VII	122
B80370	VII	30	B80443	VII	57	B80513	VII	92	B80575	VII	122
B80375	VII	30	B80444	VII	57	B805140	VII	93	B80580	VII	122
B803790	VII	38	B80445	VII	57	B805150	VII	93	B80583	VII	122
B80380	VII	38	B804460	VII	59	B805160	VII	93	B80586	VII	123
B80382	VII	38	B804461	VII	59	B805240	VII	113	B80588	VII	123
B803830	VII	38	B804462	VII	59	B805241	VII	113	B80590	VII	67
B803831	VII	38	B804463	VII	59	B805245	VII	113	B805910	VII	67
B803832	VII	38	B804464	VII	59	B805246	VII	113	B805920	VII	67
B80385	VII	38	B804465	VII	59	B805251	VII	114	B80601	VII	68
B80386	VII	39	B804466	VII	59	B805252	VII	114	B80603	VII	70
B80388	VII	39	B804467	VII	59	B80530	VII	114	B80604	VII	70

Index numérique - Numerical Index - Índice numérico

Références Referencias Referencias	Chapitre Chapter Capítulo	Page Page Página	Références Referencias Referencias	Chapitre Chapter Capítulo	Page Page Página	Références Referencias Referencias	Chapitre Chapter Capítulo	Page Page Página	Références Referencias Referencias	Chapitre Chapter Capítulo	Page Page Página
B80605	VII	68	B807677	VII	101	B808133	VII	86	B808580	VII	124
B80607	VII	69	B807680	VII	105	B808134	VII	86	B808581	VII	124
B80610	VII	68	B807681	VII	105	B808135	VII	86	B808590	VII	124
B80612	VII	69	B807682	VII	105	B808136	VII	86	B808595	VII	124
B80615	VII	68	B807683	VII	105	B808137	VII	86	B80860	VII	127
B806152	VII	68	B807685	VII	105	B808138	VII	86	B80865	VII	127
B806154	VII	68	B807686	VII	105	B808139	VII	86	B808655	VII	117
B80617	VII	69	B807690	VII	107	B80815	VII	83	B808660	VII	125
B806178	VII	71	B807692	VII	107	B808159	VII	83	B808661	VII	125
B80618	VII	72	B807693	VII	107	B80820	VII	83	B808662	VII	125
B806185	VII	71	B807694	VII	107	B808201	VII	83	B808663	VII	125
B806187	VII	71	B80770	VII	95	B808202	VII	83	B808664	VII	125
B806188	VII	71	B80775	VII	95	B808203	VII	83	B808672	VII	125
B806189	VII	71	B80780	VII	95	B808204	VII	83	B808673	VII	125
B80620	VII	75	B80785	VII	95	B808205	VII	83	B808680	VII	125
B80625	VII	75	B807860	VII	95	B808206	VII	83	B808681	VII	125
B80630	VII	75	B80790	VII	96	B808209	VII	83	B808690	VII	126
B80635	VII	75	B80792	VII	97	B808270	VII	85	B808691	VII	126
B80640	VII	74	B807922	VII	104	B808271	VII	85	B808692	VII	126
B80645	VII	73, 78	B807923	VII	104	B808274	VII	85	B808693	VII	126
B80650	VII	73, 78	B807924	VII	104	B808275	VII	85	B808694	VII	126
B80655	VII	73, 78	B807925	VII	104	B808276	VII	85	B808695	VII	126
B80660	VII	73	B807926	VII	104	B808277	VII	85	B808696	VII	126
B80665	VII	73	B807927	VII	104	B808278	VII	85	B808697	VII	126
B80670	VII	73	B80794	VII	99	B808280	VII	85	B80870	VII	126
B80675	VII	73	B807942	VII	99	B808285	VII	85	B80874	VII	126
B80680	VII	73	B80795	VII	108	B808286	VII	85	B80878	VII	126
B80685	VII	75	B807955	VII	108	B808300	VII	84	B80880	VIII	91
B80690	VII	75	B807960	VII	100	B808301	VII	84	B80885	VIII	90
B80695	VII	75	B807961	VII	100	B808310	VII	84	B808850	VIII	91
B80700	VII	75	B807962	VII	100	B808311	VII	84	B808851	VIII	91
B80705	VII	74	B807963	VII	100	B808312	VII	84	B808852	VIII	91
B80710	VII	74	B807970	VII	102	B808313	VII	84	B808890	VII	98
B80715	VII	74	B807971	VII	102	B808340	VII	72	B808895	VII	98
B80720	VII	74	B807975	VII	102	B80835	VII	72	B80890	VII	98
B80725	VII	74	B807980	VII	103	B808360	VII	72	B80895	VII	98
B80730	VII	74	B807981	VII	103	B80840	VII	72	B80900	VII	98
B80735	VII	74	B807985	VII	103	B808410	VII	72	B809020	VII	106
B80740	VII	74	B807986	VII	103	B80845	VII	131	B809021	VII	106
B80745	VII	76	B807990	VII	103	B808460	VII	131	B809022	VII	106
B807455	VII	76	B807991	VII	103	B80850	VII	82	B809023	VII	106
B80750	VII	77	B807992	VII	103	B808505	VII	128	B809030	VII	106
B80755	VII	77	B807993	VII	103	B808506	VII	128	B809031	VII	106
B80756	VII	77	B807994	VII	103	B808507	VII	128	B809032	VII	106
B807580	VII	77	B807995	VII	103	B808508	VII	128	B809033	VII	106
B80759	VII	77	B807996	VII	103	B808510	VII	82	B809034	VII	106
B80760	VII	77	B807997	VII	103	B808545	VII	130	B809035	VII	106
B807610	VII	77	B80800	VII	109	B80855	VII	130	B812001	VII	22
B807620	VII	77	B808010	VII	109	B808551	VII	130	B812002	VII	22
B80763	VII	77, 78	B808020	VII	109	B808552	VII	130	B812003	VII	22
B80765	VII	77	B808085	VII	72	B808553	VII	130	B812004	VII	22
B80767	VII	78	B808086	VII	73	B808564	VII	129	B812006	VII	22
B807671	VII	101	B808087	VII	73	B808565	VII	129	B812007	VII	22
B807672	VII	101	B80810	VII	86	B808566	VII	129	B812008	VII	22
B807673	VII	101	B808110	VII	86	B808567	VII	129	B812011	VII	22
B807675	VII	101	B80812	VII	86	B808570	VII	128	B812012	VII	22
B807676	VII	101	B80813	VII	86	B808571	VII	128	B812013	VII	22

Index numérique - Numerical Index - Índice numérico

Références References Referencias	Chapitre Chapter Capitulo	Page Page Página	Références References Referencias	Chapitre Chapter Capitulo	Page Page Página	Références References Referencias	Chapitre Chapter Capitulo	Page Page Página	Références References Referencias	Chapitre Chapter Capitulo	Page Page Página
B812014	VII	22	B813030	VII	64	B86310	III	71	B86725	II	48
B812016	VII	22	B813031	VII	64	B86315	III	71	B86730	II	49
B812017	VII	22	B813040	VII	65	B86320	III	71	B86735	II	49
B812018	VII	22	B813041	VII	65	B86325	III	72	B86740	II	49
B812025	VII	21	B813050	VII	65	B86330	III	72	B86745	II	49
B812026	VII	21	B813055	VII	65	B86335	III	72	B86750	II	50
B812101	VII	21	B813060	VII	66	B86340	III	72	B86755	II	50
B812102	VII	21	B813065	VII	66	B86345	III	72	B86760	II	50
B812103	VII	21	B813066	VII	66	B86350	III	72	B86765	II	50
B812104	VII	21	B815420	VII	116	B86355	III	73	B86770	II	50
B812105	VII	21	B815430	VII	116	B86360	III	73	B86775	II	50
B812106	VII	21	B815431	VII	116	B86365	III	73	B86780	II	50
B812107	VII	21	B815432	VII	116	B86370	III	73	B86785	II	50
B812108	VII	21	B815440	VII	116	B86375	III	73	B89000	XV	15
B812203	VII	23	B815441	VII	116	B86380	III	73	B89005	XV	15
B812204	VII	23	B815442	VII	116	B86385	III	73	B89007	XV	15
B812205	VII	23	B815450	VII	116	B86390	III	74	B890090	XV	15
B812206	VII	23	B815451	VII	116	B86395	III	74	B890091	XV	15
B812207	VII	23	B815452	VII	116	B86400	III	74	B89010	XV	16
B812208	VII	23	B817000	VII	79	B864020	III	75	B89015	XV	16
B812209	VII	23	B817001	VII	79	B864025	III	75	B89020	XV	16
B812210	VII	23	B817002	VII	79	B86405	III	82	B89025	XV	16
B812305	VII	23	B817020	VII	79	B86410	III	76	B89030	XV	16
B812306	VII	23	B817021	VII	79	B86415	III	76	B89035	XV	16
B812307	VII	23	B817022	VII	79	B86420	III	76	B89036	XV	16
B812308	VII	23	B817030	VII	79	B86425	III	76	B89037	XV	16
B812770	VII	45	B817031	VII	79	B864300	III	77	B890375	XV	15
B812771	VII	45	B817100	VII	80	B864400	III	77	B89038	XV	15
B812773	VII	45	B817120	VII	80	B864405	III	77	B890390	XV	17
B812774	VII	45	B817130	VII	80	B864500	III	78	B890391	XV	17
B812775	VII	45	B817200	VII	81	B864505	III	78	B890392	XV	17
B812800	VII	46	B817210	VII	81	B864510	III	79	B890393	XV	17
B812810	VII	47	B817220	VII	81	B864515	III	79	B89040	XV	17
B812811	VII	47	B817221	VII	81	B86500	IV	113	B89045	XV	17
B812820	VII	47	B817300	VII	81	B86505	IV	113	B890460	XV	17
B812830	VII	48	B817301	VII	81	B86510	IV	113	B890461	XV	17
B812831	VII	48	B86205	III	70	B86515	IV	113	B89050	XV	17
B812832	VII	48	B86210	III	70	B86520	IV	114	B89055	XV	17
B812833	VII	48	B86215	III	70	B86525	IV	114	B890570	XV	17
B812840	VII	48	B86220	III	70	B86530	IV	114	B890571	XV	17
B812845	VII	48	B86225	III	70	B86535	IV	114	B89058	XV	17
B812850	VII	49	B86230	III	70	B86540	IV	114	B89060	XV	17
B812851	VII	49	B86235	III	70	B86545	IV	114	B89061	XV	18
B812852	VII	49	B86240	III	70	B86550	IV	114	B89062	XV	18
B812860	VII	49	B86245	III	70	B86555	IV	114	B89063	XV	18
B812870	VII	49	B86250	III	70	B86560	IV	115	B89064	XV	18
B812871	VII	49	B86255	III	70	B86570	IV	115	B89065	XV	18
B812872	VII	49	B86260	III	70	B86580	IV	116	B89066	XV	18
B81300	VII	63	B86265	III	71	B86590	IV	116	B89067	XV	18
B813000	VII	63	B86270	III	71	B86595	IV	116	B89068	XV	18
B813001	VII	63	B86275	III	71	B86600	IV	117	B89070	XV	18
B813002	VII	63	B86280	III	71	B86610	IV	117	B89072	XV	18
B813004	VII	63	B86285	III	71	B86700	II	48	B890740	XV	18
B813012	VII	63	B86290	III	71	B86705	II	48	B890750	XV	18
B813015	VII	63	B86295	III	71	B86710	II	48	B89090	XV	20
B813020	VII	64	B86300	III	71	B86715	II	48	B89095	XV	20
B813021	VII	64	B86305	III	71	B86720	II	48	B89100	XV	20

Index numérique - Numerical Index - Índice numérico

Références Referencias Referencias	Chapitre Chapter Capítulo	Page Page Página	Références Referencias Referencias	Chapitre Chapter Capítulo	Page Page Página	Références Referencias Referencias	Chapitre Chapter Capítulo	Page Page Página	Références Referencias Referencias	Chapitre Chapter Capítulo	Page Page Página
B89110	XV	19	C095033	V	5	C100596	II	43	C102403	V	9
B89120	XV	19	C095036	V	5	C100597	II	43	C102404	V	9
B89130	XV	19	C095039	V	5	C10060	V	10	C102405	V	9
B89140	XV	19	C095042	V	5	C10065	V	10	C102406	V	9
B89150	XV	19	C095045	V	5	C10070	V	10	C102407	V	9
B89160	XV	19	C095106	V	5	C10075	V	10	C10265	V	12
B89170	XV	19	C095109	V	5	C10080	V	10	C10270	V	12
B89180	XV	19	C095112	V	5	C10085	V	10	C10275	V	12
B891900	XV	20	C095115	V	5	C10090	V	10	C10280	V	12
B892000	XV	20	C095302	V	6	C10095	V	10	C10285	V	12
B892010	XV	20	C095303	V	6	C10096	V	10	C10290	V	12
B95017	IV	110	C095304	V	6	C10098	V	10	C10295	V	12
B95020	IV	110	C095306	V	6	C10099	V	10	C10300	V	12
B95025	IV	110	C095307	V	6	C10100	V	10	C10310	V	13
B950300	IV	110	C095308	V	6	C101051	V	11	C10315	V	13
B950400	IV	110	C095310	V	6	C101101	V	11	C10320	V	13
B950450	IV	110	C095312	V	6	C101151	V	11	C10325	V	13
B950460	IV	110	C095314	V	6	C101201	V	11	C10330	V	13
B950470	IV	110	C100010	II	44	C101231	V	11	C10335	V	14
B950480	IV	110	C100011	II	44	C101251	V	11	C10340	V	14
B95060	IV	110	C100012	II	44	C101301	V	11	C10345	V	14
B95100	IV	108	C100020	II	44	C101351	V	11	C10350	V	14
B951020	IV	108	C100021	II	44	C101401	V	11	C10355	V	14
B951030	IV	108	C100022	II	44	C101421	V	11	C10360	V	14
B95150	IV	112	C100030	II	44	C10145	V	11	C10365	V	14
B95200	IV	112	C100031	II	44	C10150	V	11	C10370	V	15
B952014	IV	112	C100032	II	44	C10155	V	11	C10375	V	15
B952018	IV	112	C100040	II	44	C10170	V	9	C10380	V	15
B952020	IV	112	C100041	II	44	C101701	V	9	C10385	V	15
B95205	IV	112	C100042	II	44	C10175	V	9	C10390	V	15
B95210	IV	112	C10005	II	41	C101751	V	9	C103905	V	16
B952400	IV	111	C10010	II	41	C10180	V	9	C103910	V	16
B952450	IV	111	C10012	II	41	C101801	V	9	C103920	V	16
B952460	IV	111	C10013	II	41	C10185	V	9	C10395	V	17
B95250	IV	111	C10015	II	41	C101851	V	9	C10400	V	17
B953000	VIII	95	C10020	II	41	C10190	V	9	C10405	V	20
C010001	V	7	C10025	II	41	C101901	V	9	C10410	V	20
C010002	V	7	C10027	II	41	C10195	V	9	C10415	V	20
C010003	V	7	C10030	II	41	C101951	V	9	C10420	V	21
C010106	V	7	C10035	II	41	C10200	V	9	C10425	V	21
C010206	V	7	C10040	II	41	C102001	V	9	C10430	V	21
C010306	V	7	C10041	II	42	C10205	V	9	C10435	V	21
C010406	V	7	C10042	II	42	C102051	V	9	C10440	V	22
C011010	V	8	C10043	II	42	C10210	V	9	C10445	V	22
C011020	V	8	C10044	II	42	C102101	V	9	C10447	V	22
C011030	V	8	C10045	II	42	C10215	V	9	C10450	V	22
C011040	V	8	C10047	II	41	C102151	V	9	C10455	V	22
C011050	V	8	C10050	II	42	C10220	V	9	C10485	V	18
C011060	V	8	C10055	II	42	C102301	V	9	C10490	V	18
C012000	V	7	C10057	II	42	C102302	V	9	C10495	V	18
C012001	V	7	C100580	II	43	C102303	V	9	C10500	V	18
C012002	V	7	C100581	II	43	C102304	V	9	C10505	V	19
C012003	V	7	C100582	II	43	C102305	V	9	C10510	V	19
C012004	V	7	C100583	II	43	C102306	V	9	C10515	V	19
C09150	V	7	C100584	II	43	C102307	V	9	C10520	V	22
C091510	V	7	C100590	II	43	C102401	V	9	C10522	V	22
C095000	V	5	C100595	II	43	C102402	V	9	C10525	V	22

Index numérique - Numerical Index - Índice numérico

Références References Referencias	Chapitre Chapter Capítulo	Page Page Página	Références References Referencias	Chapitre Chapter Capítulo	Page Page Página	Références References Referencias	Chapitre Chapter Capítulo	Page Page Página	Références References Referencias	Chapitre Chapter Capítulo	Page Page Página
C10528	V	24	C10746	V	30	C109090	IV	73	C11220	V	38
C10530	V	24	C10748	V	30	C109091	IV	73	C11225	V	38
C10532	V	24	C10749	V	30	C109092	IV	73	C11230	V	38
C10535	V	24	C10751	V	30	C109095	IV	73	C11235	V	38
C10540	V	25	C10753	V	31	C109096	IV	73	C11240	V	38
C10545	V	25	C10756	V	31	C109097	IV	73	C120005	V	40
C10550	V	25	C10758	V	33	C10910	IV	74	C120010	V	40
C10555	V	25	C10759	V	33	C10915	IV	74	C120015	V	40
C10560	V	25	C10761	V	33	C10920	IV	74	C120020	V	40
C10565	V	25	C10762	V	33	C10925	IV	74	C120025	V	40
C10570	V	25	C10763	V	33	C10930	IV	74	C120030	V	40
C10575	V	26	C10764	V	33	C10935	IV	74	C120035	V	40
C10580	V	26	C10765	II	42	C10940	IV	78	C120045	V	40
C10585	V	26	C10770	II	42	C10945	IV	78	C120050	V	40
C10590	V	26	C10772	V	33	C109460	IV	76	C120070	V	40
C10595	V	23	C10774	V	33	C109461	IV	76	C120090	V	40
C10600	V	23	C10775	V	36	C109465	IV	78	C120110	V	40
C10605	V	23	C107790	V	35	C109470	IV	78	C120115	V	40
C10610	V	23	C10780	V	35	C109480	IV	79	C120120	V	40
C10615	V	24	C107810	V	35	C109485	IV	79	C120125	V	40
C10620	V	24	C10785	V	34	C109500	IV	75	C120130	V	40
C10625	V	24	C10790	V	34	C109501	IV	75	C120135	V	40
C10630	V	24	C10795	V	34	C109502	IV	75	C120140	V	40
C10631	V	27	C10800	V	34	C109503	IV	75	C120145	V	40
C10632	V	27	C108020	V	34	C11005	V	31	C120150	V	40
C10633	V	27	C10805	V	36	C11010	V	31	C120170	V	40
C10634	V	27	C10810	V	36	C11015	V	31	C120190	V	40
C10635	V	27	C10815	V	36	C11020	V	37	C120205	V	40
C10640	V	26	C10820	V	36	C11025	V	37	C120210	V	40
C10641	V	26	C10825	V	36	C11030	V	37	C120215	V	40
C10642	V	26	C10830	V	34	C11035	V	37	C120220	V	40
C10643	V	26	C10835	V	34	C11040	V	37	C120225	V	40
C10645	V	27	C10840	V	34	C11045	V	38	C120230	V	40
C10650	V	26	C108410	V	35	C11050	V	38	C120240	V	40
C10651	V	26	C10842	V	36	C11055	V	38	C120250	V	40
C10652	V	26	C10845	V	37	C11060	V	38	C120300	V	40
C10653	V	26	C10850	IV	70,91	C11065	V	38	D01010	X	12
C10655	V	28	C108530	IV	77	C11070	V	38	D010110	X	12
C10660	V	27	C108531	IV	77	C11075	V	38	D01020	X	12
C10665	V	27	C108540	IV	70	C11080	V	38	D010210	X	12
C10670	V	27	C108545	IV	70	C11085	V	38	D010290	X	12
C10675	V	28	C10855	IV	70	C11090	V	38	D01030	X	12
C10680	V	28	C10860	IV	70	C11095	V	38	D010390	X	12
C10685	V	28	C10865	IV	72	C11100	V	38	D01040	X	12
C10690	V	2	C10870	IV	72	C11105	V	38	D010440	X	13
C10695	V	29	C10875	IV	72	C11110	V	38	D010460	X	13
C10700	V	29	C10880	IV	72	C11115	V	39	D01050	X	13
C10705	V	29	C10890	IV	72	C11120	V	39	D010501	X	13
C10710	V	29	C10895	IV	72	C11125	V	39	D010502	X	13
C10715	V	23	C108990	IV	71	C11130	V	39	D010550	X	13
C10720	V	32	C108991	IV	71	C11135	V	39	D01060	X	14
C10725	V	32	C108992	IV	71	C11140	V	39	D010650	X	14
C10730	V	32	C108995	IV	71	C11145	V	39	D01070	X	14
C10735	V	32	C108996	IV	71	C11200	V	38	D010750	X	14
C10740	V	32	C108997	IV	71	C11205	V	38	D010790	X	14
C10742	V	17	C10900	IV	71	C11210	V	38	D01080	X	14
C10744	V	18	C10905	IV	71	C11215	V	38	D01090	X	14

Index numérique - Numerical Index - Índice numérico

Références Referencias Referencias	Chapitre Chapter Capítulo	Page Page Página	Références Referencias Referencias	Chapitre Chapter Capítulo	Page Page Página	Références Referencias Referencias	Chapitre Chapter Capítulo	Page Page Página	Références Referencias Referencias	Chapitre Chapter Capítulo	Page Page Página
D01100	X	14	D021102	X	5	D036030	XII	33	F10060	IV	119
D01110	VI	24	D021112	X	5	D036040	XII	33	F10100	IV	119
D011100	X	14	D021122	X	5	D036050	XII	33	F101900	IV	123
D011110	X	14	D021130	X	5	D037010	XII	33	F101910	IV	123
D01120	VI	23	D021140	X	5	D037020	XII	33	F102000	IV	124
D01130	VI	23	D021142	X	5	D037030	XII	33	F102001	IV	124
D012000	X	13	D021150	X	5	D037040	XII	33	F102005	IV	124
D012010	X	13	D021160	X	5	D037050	XII	33	F102006	IV	124
D012020	X	13	D021170	X	7	D04010	X	18	F102010	IV	124
D012030	X	13	D021180	X	7	D04020	X	18	F102011	IV	124
D020010	X	4	D021190	X	7	D040210	X	18	F102049	IV	125
D020020	X	4	D021200	X	7	D040211	X	18	F102050	IV	125
D020035	X	4	D021210	X	7	D040212	X	18	F102051	IV	125
D020040	X	4	D021220	X	7	D040390	X	19	F102052	IV	125
D020045	X	4	D021230	X	7	D040410	X	19	F102080	IV	124
D020055	X	4	D021232	X	7	D040411	X	19	F102090	IV	124
D020090	X	10	D021250	X	8	D040420	X	20	F10210	IV	124
D02010	X	10	D021260	X	8	D040440	X	19	F10220	IV	124
D02020	X	10	D021270	X	8	D04050	XII	45	F10230	IV	124
D020210	X	10	D021280	X	8	D04060	XII	45	F10240	IV	124
D020211	X	10	D03060	X	15	D040700	X	20	F10340	VIII	7
D020220	X	10	D03070	X	15	D040710	X	20	F10350	VIII	7
D020221	X	10	D03080	X	15	D040800	XII	45	F10360	VIII	7
D020290	X	10	D03090	X	15	D040801	XII	45	F10380	VIII	8
D02030	X	10	D03100	X	15	D040802	XII	45	F103801	VIII	8
D020310	X	10	D03110	X	15	DC71354-06	XII	57	F10390	VIII	8
D020400	X	9	D03120	X	15	DC71354-08	XII	57	F103901	VIII	8
D020401	X	9	D03130	X	15	DC71354-10	XII	57	F10400	VIII	8
D020410	X	9	D031400	X	16	DC71354-12	XII	57	F104001	VIII	8
D020411	X	9	D031405	X	16	F05100	III	52	F104100	VIII	8
D020420	X	9	D031410	X	17	F051001	III	52	F10420	VIII	9
D020421	X	9	D031411	X	17	F051002	III	52	F10450	VIII	9
D020430	X	11	D031420	X	17	F05110	III	52	F104580	VIII	11
D020431	X	11	D031421	X	17	F051101	III	52	F10460	VIII	11
D020440	X	11	D031430	X	17	F051102	III	52	F10470	VIII	11
D020441	X	11	D031431	X	17	F05120	III	52	F10480	VIII	12
D020442	X	11	D031440	X	17	F051201	III	52	F10505	VIII	12
D020443	X	11	D03160	X	16	F051202	III	52	F10515	VIII	12
D020450	X	11	D03170	XII	31	F05130	III	80	F105151	VIII	13
D020451	X	11	D03180	XII	31	F051310	III	80	F105152	VIII	13
D020452	X	11	D031900	XII	31	F05160	III	52	F105153	VIII	13
D020453	X	11	D031910	XII	31	F051601	III	52	F105155	VIII	14
D021000	X	6	D031920	XII	31	F051602	III	52	F10516	VIII	14
D021001	X	6	D031990	XII	30	F051650	III	68	F105165	VIII	14
D021002	X	6	D032000	XII	30	F05170	III	68	F10517	VIII	10
D021010	X	6	D032010	XII	30	F05175	III	68	F105175	VIII	10
D021011	X	6	D032020	XII	30	F05180	III	82	F105185	VIII	10
D021012	X	6	D032030	XII	30	F052000	III	68	F105450	VIII	16
D021022	X	6	D033000	XII	30	F052010	III	68	F10550	VIII	15
D021042	X	3	D034000	XII	32	F053014	III	52	F10570	VIII	15
D021052	X	3	D034010	XII	32	F053019	III	52	F105701	VIII	15
D021060	X	3	D035000	XII	32	F053022	III	52	F105760	VIII	15
D021061	X	3	D035010	XII	32	F10010	IV	119	F10580	VIII	17
D021062	X	3	D035020	XII	32	F10020	IV	119	F10590	VIII	17
D021070	X	3	D035030	XII	32	F10030	IV	119	F105910	VIII	18
D021080	X	3	D036010	XII	33	F10040	IV	119	F105911	VIII	18
D021082	X	3	D036020	XII	33	F10050	IV	119	F105912	VIII	18

Index numérique - Numerical Index - Índice numérico

Références References Referencias	Chapitre Chapter Capítulo	Page Page Página	Références References Referencias	Chapitre Chapter Capítulo	Page Page Página	Références References Referencias	Chapitre Chapter Capítulo	Page Page Página	Références References Referencias	Chapitre Chapter Capítulo	Page Page Página
F105913	VIII	18	F107210	VIII	54	F16030	VIII	31	F18135	VIII	31
F105920	VIII	18	F107220	VIII	57	F16034	VIII	31	F18230	VIII	31
F105921	VIII	18	F107230	VIII	57	F16038	VIII	31	F18235	VIII	31
F105922	VIII	18	F107240	VIII	57	F16040	VIII	31	F18240	VIII	31
F105923	VIII	18	F107250	VIII	58	F16050	VIII	31	F190010	VIII	36
F105930	VIII	19	F107260	VIII	58	F16060	VIII	31	F190020	VIII	36
F105931	VIII	19	F107270	VIII	58	F16070	VIII	33	F200050	VIII	64
F105932	VIII	19	F10730	VIII	55	F16080	VIII	33	F200060	VIII	64
F105933	VIII	19	F10732	VIII	55	F16090	VIII	33	F20010	VIII	65
F105934	VIII	19	F107330	VIII	56	F16100	VIII	33	F20020	VIII	65
F105935	VIII	19	F107340	VIII	59	F16110	VIII	33	F20030	VIII	65
F105940	VIII	19	F10735	VIII	56	F16120	VIII	33	F20070	VIII	65
F105941	VIII	19	F10736	VIII	56	F16130	VIII	33	F20090	VIII	65
F105945	VIII	21	F10737	VIII	59	F16140	VIII	33	F20092	VIII	65
F105946	VIII	21	F10738	VIII	59	F16150	VIII	33	F201000	VIII	66
F105948	VIII	21	F10740	VIII	60	F16160	VIII	33	F201010	VIII	66
F105949	VIII	21	F10755	VIII	60	F16170	VIII	33	F201020	VIII	66
F105950	VIII	22	F10780	VIII	81	F16180	VIII	33	F201100	VIII	67
F105951	VIII	22	F107870	VIII	55	F16190	VIII	33	F201110	VIII	67
F105955	VIII	22	F107900	VIII	60	F16200	VIII	33	F201120	VIII	67
F105956	VIII	22	F10800	VIII	60	F16210	VIII	33	F201130	VIII	67
F105960	VIII	23	F10805	VIII	78	F16220	VIII	33	F20160	VIII	62
F105961	VIII	23	F10810	VIII	78	F16230	VIII	33	F20165	VIII	62
F105965	VIII	23	F108180	VIII	25	F16240	VIII	33	F201655	VIII	63
F105970	VIII	16	F108190	VIII	25	F16250	VIII	33	F201660	VIII	63
F105971	VIII	16	F108200	VIII	25	F163000	VIII	34	F201665	VIII	63
F105980	VIII	20	F108205	VIII	25	F163001	VIII	34	F20290	VIII	64
F105981	VIII	20	F109200	VIII	94	F163002	VIII	34	F20295	VIII	64
F106040	VIII	24	F109210	VIII	94	F163003	VIII	34	F20300	VIII	64
F10605	VIII	24	F109220	VIII	94	F163011	VIII	34	F210010	VIII	92
F106060	VIII	24	F109300	VIII	93	F163012	VIII	34	F210020	VIII	92
F10610	VIII	26	F109310	VIII	93	F163013	VIII	34	F210030	VIII	92
F10620	VIII	27	F109315	VIII	93	F163021	VIII	35	F210110	VIII	92
F106210	VIII	27	F15310	VIII	89	F163022	VIII	35	F210120	VIII	92
F106220	VIII	28	F15320	VIII	89	F163031	VIII	35	F210130	VIII	92
F106230	VIII	28	F153340	VIII	89	F163032	VIII	35	F210210	VIII	92
F106240	VIII	28	F153341	VIII	89	F163033	VIII	35	F210220	VIII	92
F10630	VIII	26	F153350	VIII	89	F163041	VIII	35	F210250	VIII	92
F10640	VIII	27	F153351	VIII	89	F163042	VIII	35	F210260	VIII	92
F10650	VIII	29	F153352	VIII	89	F163043	VIII	35	F25010	VIII	48
F106511	VIII	29	F153360	VIII	90	F163100	VIII	34	F250110	VIII	48
F106512	VIII	29	F15340	VIII	87	F17016	VIII	31	F25020	VIII	48
F106513	VIII	29	F15350	VIII	87	F17025	VIII	31	F250210	VIII	48
F106521	VIII	29	F153510	VIII	87	F17030	VIII	31	F25025	VIII	48
F106522	VIII	29	F153520	VIII	87	F17035	VIII	31	F250260	VIII	49
F106523	VIII	29	F153540	VIII	88	F17040	VIII	31	F250261	VIII	49
F106530	VIII	30	F153610	VIII	88	F17130	VIII	31	F250265	VIII	49
F106531	VIII	30	F153620	VIII	88	F17135	VIII	31	F250266	VIII	49
F106540	VIII	30	F153626	VIII	88	F17140	VIII	31	F250270	VIII	50
F10690	VIII	52	F153628	VIII	88	F17165	VIII	31	F250271	VIII	50
F106910	VIII	52	F153630	VIII	88	F17630	VIII	32	F250272	VIII	50
F10700	VIII	52	F15370	VIII	51	F17634	VIII	32	F250273	VIII	50
F107050	VIII	81	F15380	VIII	51	F17638	VIII	32	F250274	VIII	50
F107055	VIII	81	F15390	VIII	51	F17734	VIII	32	F250275	VIII	50
F10710	VIII	53	F16000	VIII	31	F17738	VIII	32	F250276	VIII	50
F10720	VIII	54	F16010	VIII	31	F18125	VIII	31	F250277	VIII	50
F107205	VIII	54	F16020	VIII	31	F18130	VIII	31	F250278	VIII	50

Index numérique - Numerical Index - Índice numérico

Références References Referencias	Chapitre Chapter Capítulo	Page Page Página	Références References Referencias	Chapitre Chapter Capítulo	Page Page Página	Références References Referencias	Chapitre Chapter Capítulo	Page Page Página	Références References Referencias	Chapitre Chapter Capítulo	Page Page Página
F250280	VIII	37	F251790	VIII	43	F30300	VIII	69	F304110	VIII	77
F25030	VIII	37	F25180	VIII	43	F30311	VIII	74	F304112	VIII	77
F25035	VIII	37	F251840	VIII	43	F30312	VIII	74	F304114	VIII	77
F25040	VIII	37	F25185	VIII	43	F30313	VIII	74	F304130	VIII	77
F250450	VIII	37	F251900	VIII	43	F30314	VIII	74	F304140	VIII	77
F25050	VIII	37	F251950	VIII	43	F30316	VIII	74	F304150	VIII	79
F25060	VIII	37	F260010	VIII	42	F30317	VIII	74	F304160	VIII	79
F25070	VIII	37	F260020	VIII	42	F30319	VIII	74	F304170	VIII	79
F25080	VIII	37	F260030	VIII	42	F303200	VIII	74	F30420	VIII	80
F250810	VIII	37	F260040	VIII	42	F303210	VIII	74	F30455	VIII	80
F25100	VIII	38	F260050	VIII	42	F303220	VIII	74	F305000	VIII	81
F25105	VIII	38	F260060	VIII	42	F303230	VIII	74	F315005	VIII	61
F25110	VIII	39	F260070	VIII	42	F303240	VIII	74	F315006	VIII	61
F25115	VIII	39	F260080	VIII	42	F30332	VIII	74	F315007	VIII	61
F25120	VIII	40	F260090	VIII	42	F30333	VIII	74	F315015	VIII	61
F25125	VIII	40	F260100	VIII	42	F30334	VIII	74	F315016	VIII	61
F251260	VIII	47	F260110	VIII	42	F30335	VIII	74	F315017	VIII	61
F251261	VIII	47	F260120	VIII	42	F30336	VIII	74	F315020	VIII	61
F251262	VIII	47	F30010	VIII	70	F30337	VIII	74	F315021	VIII	61
F251270	VIII	46	F30015	VIII	70	F30338	VIII	74	F315022	VIII	61
F251271	VIII	46	F30020	VIII	70	F303382	VIII	74	F315122	VIII	61
F251272	VIII	46	F30030	VIII	70	F303383	VIII	74	F36010	VIII	82
F251275	VIII	46	F30040	VIII	70	F303385	VIII	74	F36015	VIII	82
F251276	VIII	46	F30050	VIII	70	F303386	VIII	74	F36020	VIII	82
F251280	VIII	41	F30060	VIII	70	F303387	VIII	74	F36025	VIII	82
F251281	VIII	41	F30070	VIII	70	F30340	VIII	71	F36030	VIII	82
F251290	VIII	41	F30080	VIII	73	F30350	VIII	71	F36035	VIII	82
F25130	VIII	44	F300801	VIII	73	F30360	VIII	71	F36040	VIII	82
F25135	VIII	44	F30090	VIII	73	F30370	VIII	71	F36045	VIII	82
F25140	VIII	44	F300901	VIII	73	F30380	VIII	71	F36050	VIII	82
F25145	VIII	44	F30100	VIII	73	F30390	VIII	71	F36055	VIII	82
F251480	VIII	44	F301001	VIII	73	F303911	VIII	72	F36060	VIII	82
F251490	VIII	44	F30110	VIII	73	F303912	VIII	72	F36065	VIII	82
F25150	VIII	44	F301101	VIII	73	F303913	VIII	72	F36070	VIII	82
F25155	VIII	44	F30120	VIII	73	F303914	VIII	72	F36075	VIII	82
F25160	VIII	44	F301201	VIII	73	F303915	VIII	72	F36080	VIII	82
F251610	VIII	43	F30130	VIII	73	F303916	VIII	72	F36085	VIII	82
F251615	VIII	43	F301301	VIII	73	F303921	VIII	72	F36090	VIII	82
F251620	VIII	44	F30140	VIII	73	F303922	VIII	72	F36095	VIII	82
F251621	VIII	44	F301401	VIII	73	F303923	VIII	72	F36100	VIII	82
F251622	VIII	44	F30150	VIII	73	F303924	VIII	72	F36105	VIII	82
F251630	VIII	45	F301501	VIII	73	F303925	VIII	72	F36110	VIII	82
F251631	VIII	45	F30160	VIII	73	F303926	VIII	72	F36115	VIII	82
F251632	VIII	45	F301601	VIII	73	F304000	VIII	75	F36120	VIII	82
F251633	VIII	45	F30170	VIII	68	F304005	VIII	75	F36125	VIII	82
F251635	VIII	45	F30180	VIII	68	F304010	VIII	75	F36130	VIII	82
F251636	VIII	45	F30190	VIII	68	F304030	VIII	75	F36135	VIII	82
F251637	VIII	45	F30200	VIII	68	F304040	VIII	75	F36140	VIII	82
F251640	VIII	43	F30210	VIII	68	F304042	VIII	75	F36145	VIII	82
F251645	VIII	43	F30220	VIII	68	F304044	VIII	75	F36150	VIII	82
F25165	VIII	43	F30230	VIII	68	F304050	VIII	76	F36155	VIII	82
F251690	VIII	43	F30245	VIII	69	F304060	VIII	76	F36160	VIII	82
F25170	VIII	43	F30250	VIII	69	F304065	VIII	76	F36165	VIII	82
F251720	VIII	43	F30260	VIII	69	F304070	VIII	76	F36170	VIII	82
F251740	VIII	43	F30270	VIII	69	F304104	VIII	77	F36175	VIII	82
F25175	VIII	43	F30280	VIII	69	F304106	VIII	77	F36180	VIII	82
F251770	VIII	43	F30290	VIII	69	F304108	VIII	77	F36185	VIII	82

Index numérique - Numerical Index - Índice numérico

Références References Referencias	Chapitre Chapter Capítulo	Page Page Página	Références References Referencias	Chapitre Chapter Capítulo	Page Page Página	Références References Referencias	Chapitre Chapter Capítulo	Page Page Página	Références References Referencias	Chapitre Chapter Capítulo	Page Page Página
F36190	VIII	82	G25135	VI	6	G30154	VI	20	G30440	VI	22
F36195	VIII	82	G25140	VI	6	G301541	VI	20	G30450	VI	22
F36200	VIII	82	G25150	VI	6	G30154L	VI	20	G30460	VI	22
F36210	VIII	82	G25160	VI	6	G30155	VI	20	G305000	VI	25
F36220	VIII	82	G254707	VI	6	G301551	VI	20	G305010	VI	25
F36230	VIII	82	G254712	VI	6	G30156	VI	20	G305015	VI	25
F36240	VIII	82	G254714	VI	6	G301561	VI	20	G305020	VI	25
F36250	VIII	82	G254716	VI	6	G30158	VI	13	G305100	VI	25
F36260	VIII	82	G254718	VI	6	G30159	VI	13	G305110	VI	25
F362610	VIII	82	G254720	VI	6	G30160	VI	21	G305115	VI	25
F362620	VIII	82	G300050	VI	9	G301601	VI	21	G305120	VI	25
F362630	VIII	82	G30010	VI	9	G30164	VI	21	G305215	VI	25
F362640	VIII	82	G300150	VI	9	G301641	VI	21	G305220	VI	25
F36270	VIII	83	G300200	VI	8	G30164L	VI	21	G305600	VI	26
F36275	VIII	83	G300205	VI	8	G30170	VI	21	G305630	VI	26
F36280	VIII	83	G300210	VI	8	G301701	VI	21	G305640	VI	26
F36285	VIII	83	G300215	VI	8	G30170L	VI	21	G305660	VI	26
F36300	VIII	85	G300220	VI	8	G30180	VI	21	G305670	VI	26
F36310	VIII	85	G300230	VI	10	G301801	VI	21	G305680	VI	26
F36315	VIII	85	G300240	VI	10	G30182	VI	21	G30610	XIV	29
F363155	VIII	85	G300250	VI	12	G301821	VI	21	G306300	XIV	29
F363200	VIII	85	G300260	VI	12	G30190	VI	21	G30640	XIV	29
F36400	VIII	84	G300300	VI	12	G301901	VI	21	G35004	VI	27
F36410	VIII	84	G300305	VI	12	G301950	VI	23	G35008	VI	27
F36420	VIII	84	G300310	VI	12	G301960	VI	23	G35012	VI	27
F36430	VIII	84	G30060	VI	10	G301990	VI	23	G35016	VI	27
F36440	VIII	84	G30070	VI	10	G30200	VI	23	G35132	VI	27
F36450	VIII	84	G30080	VI	9	G30210	VI	16	G35136	VI	27
F36460	VIII	84	G300805	VI	11	G30220	VI	16	G35140	VI	27
F36470	VIII	84	G300810	VI	11	G30220L	VI	16	G35144	VI	27
F36480	VIII	84	G300815	VI	11	G30230	VI	16	G40050	VI	28
F36485	VIII	84	G30082	VI	11	G30230L	VI	16	G40060	VI	28
F36490	VIII	84	G30084	VI	11	G30240	VI	16	G40070	VI	28
F36494	VIII	84	G30086	VI	11	G30240L	VI	16	G40080	VI	28
F36498	VIII	84	G30088	VI	11	G30250	VI	16	G40100	VI	29
F365050	VIII	84	G300891	VI	14	G30260	VI	16	G40110	VI	29
F365060	VIII	84	G300892	VI	14	G30270	VI	16	G40120	VI	29
F365070	VIII	84	G300893	VI	14	G30280	VI	18	G40135	VI	29
F365080	VIII	84	G300895	VI	11	G30290	VI	18	G401360	VI	29
F365090	VIII	84	G30090	VI	15	G30300	VI	18	G401750	VI	30
F365100	VIII	84	G300950	VI	15	G30310	VI	18	G40180	VI	30
F365200	VIII	84	G30100	VI	15	G303110	VI	18	G40190	VI	30
F365201	VIII	84	G30100L	VI	15	G303120	VI	18	G401950	VI	30
F365202	VIII	84	G30110	VI	15	G303200	VI	22	G40200	VI	30
F365203	VIII	84	G30110L	VI	15	G303201	VI	22	G402050	VI	30
F365204	VIII	84	G30120	VI	15	G303202	VI	22	G402070	VI	30
F365205	VIII	84	G30120L	VI	15	G303203	VI	22	G40210	VI	30
F365206	VIII	84	G30130	VI	15	G303210	VI	22	G40215	VI	30
F365207	VIII	84	G30140	VI	15	G303215	VI	22	G402350	VI	30
G25010	VI	5	G30150	VI	15	G303290	VI	17	G40240	VI	30
G25020	VI	5	G30151	VI	13	G303300	VI	17	G40250	VI	30
G25030	VI	5	G30152	VI	20	G303301	VI	17	G402550	VI	30
G25040	VI	5	G301521	VI	20	G303310	VI	17	G40260	VI	30
G250410	VI	5	G30152L	VI	20	G303320	VI	17	G402650	VI	30
G25050	VI	7	G30153	VI	20	G30370	VI	19	G402670	VI	30
G25060	VI	7	G301531	VI	20	G30380	VI	19	G40270	VI	30
G25080	VI	7	G30153L	VI	20	G30390	VI	19	G40275	VI	30

Index numérique - Numerical Index - Índice numérico

Références Referencias Referencias	Chapitre Chapter Capítulo	Page Page Página	Références Referencias Referencias	Chapitre Chapter Capítulo	Page Page Página	Références Referencias Referencias	Chapitre Chapter Capítulo	Page Page Página	Références Referencias Referencias	Chapitre Chapter Capítulo	Page Page Página
G40340	VI	32	H20082	IX	12	H40040	IX	14	I150311	XII	15
G403401	VI	32	H20083	IX	12	H40050	IX	14	I15032	XII	15
G403402	VI	32	H20085	VII	12	H40060	IX	14	I15034	XII	15
G40350	VI	32	H20087	VII	12	H40070	IX	14	I15036	XII	15
G403501	VI	32	H20089	VII	12	H40080	IX	14	I15038	XII	15
G403502	VI	32	H20091	VII	12	H40090	IX	14	I15042	XII	15
G403510	VI	31	H20093	VII	12	H40100	IX	14	I15044	XII	15
G403520	VI	31	H20095	VII	12	H40110	IX	14	I150441	II	40
G403540	VI	31	H200961	VII	12	H40120	IX	14	I150442	II	40
G403550	VI	31	H200962	VII	12	H40130	IX	14	I150443	II	40
G403600	VI	33	H200963	VII	12	I05010	XII	7	I150444	II	40
G403610	VI	33	H200964	VII	12	I05020	XII	7	I150445	II	40
G403620	VI	33	H200965	VII	12	I05030	XII	7	I150446	II	40
G403630	VI	34	H200966	VII	12	I050410	XII	7	I150490	II	38
G403640	VI	34	H20110-0	VIII	86	I05050	XII	8	I15050	II	38
G403650	VI	34	H210002	IX	13	I05060	XII	8	I150501	II	38
H10010	IX	4	H210003	IX	13	I050690	XII	9	I150502	II	38
H10020	IX	4	H210004	IX	13	I05070	XII	9	I150503	II	38
H10030	IX	4	H210005	IX	13	I05080	XII	9	I150504	II	38
H10040	IX	4	H210006	IX	13	I050810	XII	9	I150505	II	38
H10050	IX	4	H210008	IX	13	I05120	XII	8	I150590	II	38
H10060	IX	5	H210011	IX	13	I051210	XII	8	I15060	II	38
H10070	IX	5	H210015	IX	13	I051310	XII	10	I150601	II	38
H10080	IX	5	H250140	VIII	86	I051319	XII	10	I150602	II	38
H10090	IX	5	H250160	VIII	86	I051320	XII	10	I150603	II	38
H100910	IX	3	H250180	VIII	86	I051321	XII	10	I150604	II	38
H100911	IX	3	H250200	VIII	86	I051322	XII	10	I150605	II	38
H100921	IX	3	H250220	VIII	86	I051325	XII	10	I150610	II	39
H100922	IX	3	H250240	VIII	86	I051326	XII	10	I150611	II	39
H100923	IX	3	H250260	VIII	86	I051327	XII	10	I150612	II	39
H100924	IX	3	H250280	VIII	86	I051328	XII	10	I150620	II	40
H10100	IX	6	H250300	VIII	86	I051329	XII	10	I150621	II	40
H10115	IX	6	H250320	VIII	86	I051410	XII	11	I150630	II	40
H10120	IX	6	H250340	VIII	86	I051415	XII	11	I150640	II	40
H10130	IX	6	H250360	VIII	86	I051416	XII	11	I15070	XII	13
H101310	IX	7	H250380	VIII	86	I051417	XII	11	I15080	XII	13
H101311	IX	7	H250400	VIII	86	I051418	XII	11	I150810	XII	13
H101320	IX	7	H250420	VIII	86	I051419	XII	11	I150815	XII	13
H101321	IX	7	H250440	VIII	86	I051510	XII	11	I150820	XII	13
H101330	IX	7	H250460	VIII	86	I051515	XII	11	I150880	II	36
H10140	VIII	95	H250480	VIII	86	I051516	XII	11	I150881	II	36
H10145	VIII	95	H250500	VIII	86	I051517	XII	11	I150882	II	36
H10150	VIII	95	H250520	VIII	86	I052100	XII	9	I150885	II	36
H10170	VII	93	H250540	VIII	86	I052110	XII	9	I150886	II	36
H10175	IX	11	H250560	VIII	86	I052120	XII	9	I150887	II	36
H200110	IX	11	H250580	VIII	86	I052130	XII	9	I150890	II	36
H200120	IX	11	H250600	VIII	86	I10010	XII	12	I150895	II	36
H20025	IX	12	H251010	VIII	86	I10015	XII	12	I15110	II	36
H20030	IX	12	H251012	VIII	86	I10020	XII	12	I15120	II	36
H20040	IX	12	H251016	VIII	86	I10022	XII	12	I151305	XII	17
H20050	IX	12	H251018	VIII	86	I10024	XII	12	I151306	XII	17
H20060	IX	12	H251110	VIII	86	I100300	XII	12	I151310	XII	17
H20070	IX	12	H251112	VIII	86	I15010	XII	14	I151311	XII	17
H20071	IX	12	H251116	VIII	86	I15020	XII	14	I151312	XII	17
H20072	IX	12	H40010	IX	14	I150250	XII	14	I151382	XII	16
H20080	IX	12	H40020	IX	14	I15030	XII	14	I151383	XII	16
H20081	IX	12	H40030	IX	14	I150310	XII	15	I151384	XII	16

Index numérique - Numerical Index - Índice numérico

Références References Referencias	Chapitre Chapter Capitulo	Page Page Página	Références References Referencias	Chapitre Chapter Capitulo	Page Page Página	Références References Referencias	Chapitre Chapter Capitulo	Page Page Página	Références References Referencias	Chapitre Chapter Capitulo	Page Page Página
I151385	XII	16	I153980	XII	24	I162030	XII	35	I171103	XII	28
I151386	XII	16	I153981	XII	24	I162040	XII	35	I171112	XII	42
I151388	XII	16	I153982	XII	24	I162041	XII	35	I171114	XII	52
I15141-0	XII	16	I153983	XII	24	I162042	XII	35	I171116	XII	42
I15142-0	XII	16	I153985	XII	24	I170005	XII	37	I171170	XII	42
I15145-0	XII	16	I153986	XII	24	I170006	XII	37	I171118	XII	42
I15146-0	XII	16	I153990	XII	24	I170007	XII	37	I171242	XII	44
I15147-0	XII	16	I153991	XII	24	I170008	XII	37	I171243	XII	44
I15148-0	XII	16	I153992	XII	24	I170009	XII	37	I171245	XII	44
I15150	XII	16	I153993	XII	24	I17001	XII	37	I171246	XII	44
I15151	XII	16	I153995	XII	24	I170010	XII	37	I171247	XII	44
I15160	XII	16	I153996	XII	24	I170011	XII	37	I171248	XII	44
I15170	XII	16	I154903	XII	24	I170012	XII	37	I171249	XII	44
I15175	XII	18	I154904	XII	24	I170013	XII	37	I171260	XII	43
I15180	XII	18	I154905	XII	24	I170020	XII	37	I171270	XII	43
I15185	XII	18	I154913	XII	24	I170021	XII	37	I171274	XII	43
I151855	XII	18	I154914	XII	24	I170022	XII	37	I171275	XII	43
I151860	XII	18	I154915	XII	24	I170023	XII	37	I171280	XII	44
I151861	XII	18	I15495	XII	25	I170030	XII	39	I171290	XII	52
I151862	XII	18	I15500	XII	25	I170031	XII	39	I171292	XII	52
I151863	XII	18	I155010	XII	25	I170032	XII	39	I171295	XII	52
I151871	XII	19	I15701	XII	26	I170040	XII	39	I171297	XII	52
I151872	XII	19	I15703	XII	26	I170042	XII	39	I171300	XII	52
I151881	XII	19	I15704	XII	26	I170044	XII	39	I171305	XII	46
I151882	XII	19	I15705	XII	26	I170046	XII	39	I171306	XII	46
I151883	XII	19	I16005	XII	27	I170191	XII	38	I171307	XII	46
I15190	XII	20	I16010	XII	27		XIII	68	I171308	XII	46
I15200	XII	20	I16015	XII	27	I170192	XII	38	I171310	XII	47
I152001	XII	20	I16020	XII	27		XIII	68	I171311	XII	47
I152002	XII	20	I160250	XII	28	I170193	XII	38	I171312	XII	47
I152003	XII	20	I160255	XII	28		XIII	68	I171315	XII	47
I152004	XII	20	I160260	XII	28	I170194	XII	38	I171318	XII	47
I152090	XII	20	I160300	XII	34		XIII	68	I171322	XII	47
I152091	XII	20	I160310	XII	34	I170195	XII	38	I171325	XII	47
I152092	XII	20	I16035	XII	29		XIII	68	I171330	XII	49
I152100	XII	21	I160360	XII	29	I170196	XII	38	I171331	XII	49
I152101	XII	21	I16040	XII	34		XIII	68	I171332	XII	49
I152102	XII	21	I160439	XII	27	I170197	XII	38	I171335	XII	49
I152106	XII	21	I16055	XII	28		XIII	68	I171340	XII	49
I152115	XII	21	I160570	XII	28	I170198	XII	38	I171355	XII	46
I15220	XII	22	I16060	XII	28		XIII	68	I171360	XII	50
I152255	I	5	I160611	XII	28	I170460	XII	38	I171361	XII	50
I15230	XII	22	I160620	XII	28	I170461	XII	38	I171365	XII	50
I15232	XII	22	I16100	XII	36	I170920	XII	40	I171370	XII	50
I15234	XII	22	I16102	XII	36	I170924	XII	40	I171375	XII	50
I15240	XII	22	I16104	XII	36	I170926	XII	40	I171380	XII	51
I15250	XII	22	I16106	XII	36	I170928	XII	40	I171381	XII	51
I15330	XII	25	I16108	XII	36	I170940	XII	40	I171390	XII	51
I15340	XII	23	I16110	XII	36	I170941	XII	40	I171395	XII	51
I15342	XII	23	I16112	XII	36	I170942	XII	40	I17140	XII	48
I15344	XII	23	I16114	XII	36	I17100	XII	41	I17142	XII	48
I15346	XII	23	I162000	XII	35	I17102	XII	41	I17144	XII	48
I15348	XII	23	I162001	XII	35	I17104	XII	41	I17146	XII	48
I15350	XII	23	I162010	XII	35	I171060	XII	41	I17148	XII	48
I15360	XII	23	I162011	XII	35	I171071	XIII	40	I171481	XII	48
I15370	XII	23	I162020	XII	35	I17108	XII	40	I171490	XII	52
I153978	XII	24	I162021	XII	35	I17110	XII	40	I17150	XII	52

Index numérique - Numerical Index - Índice numérico

Références References Referencias	Chapitre Chapter Capítulo	Page Page Página	Références References Referencias	Chapitre Chapter Capítulo	Page Page Página	Références References Referencias	Chapitre Chapter Capítulo	Page Page Página	Références References Referencias	Chapitre Chapter Capítulo	Page Page Página
I17155	XII	52	I180716	XII	59	J041000	XIII	14	J122610	XIII	20
I17160	XII	54	I180717	XII	59	J041010	XIII	14	J12270	XIII	21
I17162	XII	54	I180718	XII	59	J041020	XIII	14	J12285	XIII	20
I180000	XII	54	I180720	XII	59	J041030	XIII	14	J14020	XIII	22
I180002	XII	55	I180721	XII	59	J041040	XIII	14	J140210	XIII	22
I180003	XII	55	I180722	XII	59	J041050	XIII	14	J140310	XIII	22
I180004	XII	55	I180723	XII	59	J041060	XIII	14	J140400	XIII	22
I180022	XII	56	I180724	XII	59	J041070	XIII	14	J140410	XIII	22
I180023	XII	56	I180733	XII	60	J041080	XIII	14	J140610	XIII	23
I180030	XII	56	I180743	XII	60	J041090	XIII	13	J140620	XIII	23
I180031	XII	56	I180753	XII	60	J041095	XIII	13	J140710	XIII	23
I180032	XII	56	I180754	XII	60	J08010	XIII	48	J140801	XIII	23
I180033	XII	56	I182015	XII	57	J080101	XIII	48	J140802	XIII	23
I180035	XII	56	I182020	XII	57	J08030	XIII	63	J140803	XIII	23
I180036	XII	56	I182025	XII	57	J08031	XIII	63	J140804	XIII	23
I180037	XII	56	I182030	XII	57	J08035	XII	45	J140805	XIII	23
I180038	XII	56	I182102	XII	58		XIII	24	J140806	XIII	23
I18005	XII	54	I182103	XII	58	J08060	XIII	37	J14090	XIII	21
I18010	XII	54	I182104	XII	58	J08070	XIII	37	J141100	XIII	16
I18020	XII	54	I182105	XII	58	J080710	XIII	36	J141110	XIII	16
I18021	XII	54	I182106	XII	58	J08080	XIII	28	J141120	XIII	16
I18022	XII	54	I182108	XII	58	J080900	XIII	37	J141130	XIII	16
I18024	XII	54	I182109	XII	58	J080901	XIII	37	J141140	XIII	17
I18025	XII	54	I182201	XII	58	J081000	XIII	36	J141150	XIII	17
I18027	XII	54	I182202	XII	58	J081010	XIII	36	J141160	XIII	17
I18028	XII	54	I182203	XII	58	J081020	XIII	36	J141200	XIII	17
I18030	XII	54	I182204	XII	58	J081030	XIII	36	J141290	XIII	15
I18031	XII	54	I182205	XII	58	J082020	V	6	J141300	XIII	15
I18033	XII	54	I182206	XII	58	J082030	V	6	J141310	XIII	15
I18034	XII	54	I182208	XII	58	J12030	XIII	15	J14140	XIII	15
I18036	XII	54	I182209	XII	58	J12060	XIII	15	J14145	III	87
I18037	XII	54	I190050	III	84	J120649	XIII	15	J141460	III	87
I180372	XII	55	I190060	III	84	J120650	XIII	15	J150100	XI	3
I180373	XII	55	I190070	III	83	J120651	XIII	15	J150110	XI	3
I180374	XII	55	I190075	III	83	J120652	XIII	15	J150120	XI	3
I180375	XII	55	I190080	III	84	J120700	XIII	18	J150130	XI	3
I180376	XII	55	I190085	III	84	J120827	XIII	18	J150140	XI	3
I180377	XII	55	I190090	III	84	J120828	XIII	18	J150150	XI	3
I180380	XII	55	I19010	III	83	J120830	XIII	18	J150160	XI	3
I180381	XII	55		XII	53	J120831	XIII	18	J150170	XI	3
I180382	XII	55	I19020	III	83	J120931	XIII	18	J150180	XI	3
I180385	XII	56		XII	53	J121612	XIII	19	J150190	XI	3
I180386	XII	56	I19030	XII	53	J121615	XIII	19	J151010	XI	4
I180387	XII	56	I19040	XII	53	J121623	XIII	19	J151011	XI	4
I180502	XII	57	I19050	XII	53	J121625	XIII	19	J151012	XI	4
I180503	XII	57	J04010	XIII	11	J121627	XIII	19	J151013	XI	4
I180504	XII	57	J04040	XIII	11	J12190	XIII	19	J151020	XI	4
I180515	XII	57	J040410	XIII	11	J12220	XIII	19	J151021	XI	4
I180703	XII	59	J040420	XIII	11	J12225	XIII	19	J151022	XI	4
I180704	XII	59	J040430	XIII	11	J12230	XIII	18	J151023	XI	4
I180705	XII	59	J04050	XIII	12	J12240	XIII	20	J151030	XI	4
I180706	XII	59	J04070	XIII	12	J12250	XIII	20	J151031	XI	4
I180707	XII	59	J040802	XIII	12	J122530	XIII	20	J151040	XI	5
I180708	XII	59	J040803	XIII	12	J122540	XIII	20	J151041	XI	5
I180713	XII	59	J040804	XIII	12	J122550	XIII	20	J151042	XI	5
I180714	XII	59	J040806	XIII	12	J122590	XIII	20	J151043	XI	5
I180715	XII	59	J04090	XIII	13	J12260	XIII	20	J151044	XI	5

Index numérique - Numerical Index - Índice numérico

Références References Referencias	Chapitre Chapter Capítulo	Page Page Página	Références References Referencias	Chapitre Chapter Capítulo	Page Page Página	Références References Referencias	Chapitre Chapter Capítulo	Page Page Página	Références References Referencias	Chapitre Chapter Capítulo	Page Page Página
J151045	XI	5	J162240	XIII	26	J170562	XI	11	J1709346	XI	12
J151050	XI	5	J16230	XIII	27	J170563	XI	11	J1709347	XI	12
J151051	XI	5	J162310	XIII	24	J170564	XI	11	J1709348	XI	12
J151052	XI	5	J162320	XIII	24	J170566	XI	11	J1709380	XI	13
J151053	XI	5	J162330	XIII	24	J170567	XI	11	J1709381	XI	13
J151060	XI	5	J162345	XIII	27	J17060	XI	11	J1709382	XI	13
J151061	XI	5	J162350	XIII	25	J17065	XI	11	J1709383	XI	13
J152000	XI	7	J16240	XIII	25	J17070	XI	11	J1709384	XI	13
J152001	XI	6	J162410	XIII	25	J170750	XI	14	J1709385	XI	13
J152002	XI	6	J16245	XIII	25	J170751	XI	14	J1709386	XI	13
J152003	XI	6	J162460	XIII	25	J170752	XI	14	J1709387	XI	13
J152100	XI	8	J16250	XIII	32	J17080	XI	14	J1709388	XI	13
J152101	XI	8	J16255	XIII	32	J17085	XI	14	J1709389	XI	13
J152110	XI	8	J162561	XIII	32	J170860	XI	14	J170940	XI	17
J152111	XI	8	J162563	XIII	32	J170898	XI	14	J170940B	XI	19
J152120	XI	7	J162565	XIII	32	J170899	XI	14	J17095	XI	17
J152121	XI	7	J16260	XIII	26	J17090	XI	14	J17095B	XI	19
J152204	XI	7	J16265	XIII	26	J170901	XI	15	J17100	XI	17
J152206	XI	7	J16270	XIII	29	J170902	XI	15	J17100B	XI	19
J152208	XI	7	J162702	XIII	29	J170903	XI	15	J17110	XI	17
J152210	XI	7	J162710	XIII	29	J170904	XI	15	J17110B	XI	19
J152303	XI	8	J162720	XIII	29	J170905	XI	15	J17115	XI	17
J152305	XI	8	J16275	XIII	28	J170906	XI	15	J17115B	XI	19
J152307	XI	8	J162801	XIII	25	J170907	XI	15	J171170	XI	16
J16010	XI	9	J162802	XIII	25	J170908	XI	15	J171170B	XI	19
J16020	XI	9	J162803	XIII	25	J170909	XI	15	J171170E	XI	18
J160210	XI	9	J17001	XI	11	J170910	XI	12	J171170ET	XI	18
J160225	XI	9	J17002	XI	11	J170911	XI	12	J171170TB	XI	19
J160226	XI	9	J17003	XI	11	J170913	XI	12	J17118	XI	16
J160227	XI	9	J170040	XI	11	J170914	XI	12	J171180ET	XI	18
J16030	XI	9	J170041	XI	11	J170916	XI	12	J171180TB	XI	19
J16040	XI	9	J170042	XI	11	J170917	XI	12	J17118B	XI	19
J16050	XI	9	J170043	XI	11	J170919	XI	12	J17118E	XI	18
J160550	XI	9	J170044	XI	11	J170920	XI	12	J17120	XI	16
J16060	XI	9	J170046	XI	11	J170921	XI	12	J171200ET	XI	18
J16065	XI	9	J170047	XI	11	J170922	XI	12	J171200TB	XI	19
J16075	XI	9	J17005	XI	11	J170923	XI	12	J17120B	XI	19
J160760	XI	9	J17006	XI	11	J170925	XI	12	J17120E	XI	18
J160770	XI	9	J17007	XI	11	J170926	XI	12	J17130	XI	16
J160780	XI	9	J17010	XI	11	J170927	XI	12	J171300ET	XI	18
J160790	XI	9	J17012	XI	11	J170928	XI	12	J171300TB	XI	19
J161000	XI	10	J17015	XI	11	J170929	XI	12	J17130B	XI	19
J161010	XI	10	J170160	XI	11	J170931	XI	12	J17130E	XI	18
J161020	XI	10	J170161	XI	11	J170932	XI	12	J17140	XI	16
J161030	XI	10	J170162	XI	11	J1709330	XI	12	J171400ET	XI	18
J161040	XI	10	J170163	XI	11	J1709333	XI	12	J171400TB	XI	19
J161050	XI	10	J170164	XI	11	J1709334	XI	12	J17140B	XI	19
J161060	XI	10	J170166	XI	11	J1709335	XI	12	J17140E	XI	18
J161080	XI	10	J170167	XI	11	J1709336	XI	12	J171821	XI	17
J161090	XI	10	J17020	XI	11	J1709337	XI	12	J171822	XI	17
J161100	XI	10	J17025	XI	11	J1709338	XI	12	J171823	XI	17
J162200	XIII	37	J17035	XI	11	J1709339	XI	12	J171824	XI	17
J162210	XIII	34	J17045	XI	11	J1709340	XI	12	J171825	XI	17
J162220	XIII	28	J17050	XI	11	J1709341	XI	12	J171831	XI	17
J162222	XIII	28	J17055	XI	11	J1709342	XI	12	J171831ET	XI	18
J162223	XIII	28	J170560	XI	11	J1709343	XI	12	J171832	XI	17
J162230	XIII	26	J170561	XI	11	J1709345	XI	12	J171832ET	XI	18

Index numérique - Numerical Index - Índice numérico

Références References Referencias	Chapitre Chapter Capítulo	Page Page Página	Références References Referencias	Chapitre Chapter Capítulo	Page Page Página	Références References Referencias	Chapitre Chapter Capítulo	Page Page Página	Références References Referencias	Chapitre Chapter Capítulo	Page Page Página
J171833	XI	17	J172512	XI	16	J202014E	XI	22	J24110	XIII	44
J171833ET	XI	18	J172512B	XI	19	J202014EB	XI	23	J24120	XIII	44
J171834	XI	17	J172512TB	XI	19	J202014ET	XI	22	J24130	XIII	44
J171834ET	XI	18	J172513	XI	16	J202014ETB	XI	23	J24140	XIII	44
J171835	XI	17	J172513TB	XI	19	J202015E	XI	22	J24150	XIII	44
J171835ET	XI	18	J172514	XI	16	J202015EB	XI	23	J24160	XIII	44
J172001	XI	17	J172514B	XI	19	J202015ET	XI	22	J241690	XIII	45
J172002	XI	17	J172514TB	XI	19	J202015ETB	XI	23	J24170	XIII	45
J172003	XI	17	J172515	XI	16	J202016E	XI	22	J241790	XIII	45
J172003B	XI	19	J172515B	XI	19	J202016EB	XI	23	J24180	XIII	45
J172004	XI	17	J172515TB	XI	19	J202311E	XI	22	J241810	XIII	45
J172004B	XI	19	J172803	XI	17	J202311EB	XI	23	J241811	XIII	45
J172005	XI	17	J172804	XI	17	J202312E	XI	22	J241901	XIII	46
J172005B	XI	19	J172805	XI	17	J202312EB	XI	23	J241902	XIII	46
J172011	XI	16	J172813	XI	16	J202312ET	XI	22	J241903	XIII	46
J172011B	XI	19	J172814	XI	16	J202312ETB	XI	23	J241904	XIII	46
J172011E	XI	18	J172815	XI	16	J202313E	XI	22	J241905	XIII	46
J172011ET	XI	18	J201811E	XI	22	J202313EB	XI	23	J241906	XIII	46
J172011TB	XI	19	J201811EB	XI	23	J202313ET	XI	22	J241907	XIII	46
J172012	XI	16	J201811ET	XI	22	J202313ETB	XI	23	J241908	XIII	46
J172012B	XI	19	J201811ETB	XI	23	J202314E	XI	22	J241910	XIII	38
J172012E	XI	18	J201812E	XI	22	J202314EB	XI	23	J241911	XIII	38
J172012ET	XI	18	J201812EB	XI	23	J202314ET	XI	22	J241912	XIII	38
J172012TB	XI	19	J201812ET	XI	22	J202314ETB	XI	23	J241913	XIII	38
J172013	XI	16	J201812ETB	XI	23	J202315E	XI	22	J241915	XIII	38
J172013B	XI	19	J201813E	XI	22	J202315EB	XI	23	J24192	XIII	49
J172013E	XI	18	J201813EB	XI	23	J202315ET	XI	22	J24193	XIII	49
J172013ET	XI	18	J201813ET	XI	22	J202315ETB	XI	23	J24194	XIII	49
J172013TB	XI	19	J201813ETB	XI	23	J202323E	XI	22	J24195	XIII	49
J172014	XI	16	J201814E	XI	22	J202324E	XI	22	J242155	XIII	47
J172014B	XI	19	J201814EB	XI	23	J202325E	XI	22	J242160	XIII	47
J172014E	XI	18	J201814ET	XI	22	J202811E	XI	22	J242170	XIII	47
J172014ET	XI	18	J201814ETB	XI	23	J202811EB	XI	23	J242180	XIII	47
J172014TB	XI	19	J201815E	XI	22	J202812E	XI	22	J24219	XIII	49
J172015	XI	16	J201815EB	XI	23	J202812EB	XI	23	J24220	XIII	49
J172015B	XI	19	J201815ET	XI	22	J202813E	XI	22	J24230	XIII	49
J172015E	XI	18	J201815ETB	XI	23	J202813EB	XI	23	J24240	XIII	49
J172015ET	XI	18	J201823E	XI	22	J202814E	XI	22	J24250	XIII	49
J172015TB	XI	19	J201824E	XI	22	J202814EB	XI	23	J24260	XIII	49
J172016	XI	16	J201825E	XI	22	J202815E	XI	22	J24270	XIII	49
J172016E	XI	18	J201831E	XI	22	J202815EB	XI	23	J24280	XIII	50
J172016ET	XI	18	J201832E	XI	22	J231360	XV	8	J24282	XIII	50
J172021	XI	17	J201833E	XI	22	J231362	XV	8	J24284	XIII	50
J172022	XI	17	J201834E	XI	22	J231364	XV	8	J24290	XIII	50
J172023	XI	17	J201835E	XI	22	J231366	XV	8	J24300	XIII	50
J172024	XI	17	J202011E	XI	22	J235504	XIII	27	J24310	XIII	50
J172025	XI	17	J202011EB	XI	23	J235505	XIII	29	J24320	XIII	50
J172312	XI	16	J202011ET	XI	22	J24010	XIII	44	J24360	XIII	47
J172313	XI	16	J202011ETB	XI	23	J24020	XIII	44	J24370	XIII	47
J172314	XI	16	J202012E	XI	22	J24030	XIII	44	J243705	XIII	48
J172315	XI	16	J202012EB	XI	23	J24040	XIII	44	J243706	XIII	48
J172333	XI	17	J202012ET	XI	22	J24050	XIII	44	J24371	XIII	48
J172333ET	XI	18	J202012ETB	XI	23	J24060	XIII	44	J243712	XIII	31
J172334	XI	17	J202013E	XI	22	J24070	XIII	44	J243713	XIII	31
J172334ET	XI	18	J202013EB	XI	23	J24078	XIII	44	J243716	XIII	30
J172335	XI	17	J202013ET	XI	22	J24080	XIII	44	J243717	XIII	30
J172335ET	XI	18	J202013ETB	XI	23	J24090	XIII	44	J243718	XIII	30

Index numérique - Numerical Index - Índice numérico

Références References Referencias	Chapitre Chapter Capítulo	Page Page Página	Références References Referencias	Chapitre Chapter Capítulo	Page Page Página	Références References Referencias	Chapitre Chapter Capítulo	Page Page Página	Références References Referencias	Chapitre Chapter Capítulo	Page Page Página
J243719	XIII	30	J244900	XIII	43	J252012ET	XI	20	J28005	XIII	55
J24372	XIII	27	J245000	XIII	43	J252013E	XI	20	J28010	XIII	55
J243720	XIII	26	J245010	XIII	43	J252013ET	XI	20	J28020	XIII	55
J243721	XIII	26	J245020	XIII	43	J252014E	XI	20	J28030	XIII	55
J243722	XIII	27	J245110	XIII	41	J252014ET	XI	20	J28040	XIII	55
J243724	XIII	31	J245120	XIII	41	J252015E	XI	20	J28050	XIII	55
J243725	XIII	30	J245130	XIII	41	J252015ET	XI	20	J28060	XIII	55
J243726	XIII	31	J245131	XIII	41	J252031E	XI	21	J28070	XIII	55
J243727	XIII	31	J245132	XIII	41	J252031ET	XI	21	J28080	XIII	55
J243728	XIII	35	J245133	XIII	41	J252032E	XI	21	J28090	XIII	55
J243729	XIII	35	J245134	XIII	41	J252032ET	XI	21	J28110	XIII	55
J24373	XIII	35	J245135	XIII	41	J252033E	XI	21	J28130	XIII	55
J243731	XIII	35	J245137	XIII	41	J252033ET	XI	21	J28150	XIII	55
J243732	XIII	35	J245138	XIII	41	J252034E	XI	21	J281507	XIII	55
J243735	XIII	35	J245139	XIII	42	J252034ET	XI	21	J281508	XIII	55
J243736	XIII	35	J245140	XIII	42	J252035E	XI	21	J281509	XIII	55
J243738	XIII	32	J245141	XIII	42	J252035ET	XI	21	J28151	XIII	55
J243739	XIII	51	J245145	XIII	42	J252311E	XI	20	J281515	XIII	55
J24374	XIII	51	J245146	XIII	42	J252311ET	XI	20	J28152	XIII	55
J24376	XIII	51	J245147	XIII	42	J252312E	XI	20	J281525	XIII	55
J243770	XIII	51	J245150	XIII	42	J252312ET	XI	20	J28153	XIII	55
J243772	XIII	51	J245200	XIII	40	J252313E	XI	20	J281535	XIII	55
J243773	XIII	51	J245201	XIII	40	J252313ET	XI	20	J28155	XIII	55
J243774	XIII	51	J245202	XIII	40	J252314E	XI	20	J28156	XIII	55
J243775	XIII	51	J245203	XIII	40	J252314ET	XI	20	J28157	XIII	55
J243776	XIII	51	J245210	XIII	40	J252315E	XI	20	J28158	XIII	55
J243777	XIII	51	J245211	XIII	40	J252315ET	XI	20	J281620	XIII	56
J243778	XIII	51	J245212	XIII	40	J252331E	XI	21	J28163	XIII	56
J24378	XIII	33	J245213	XIII	40	J252331ET	XI	21	J28170	XIII	56
J24380	XIII	33	J245220	XIII	39	J252332E	XI	21	J28180	XIII	56
J24390	XIII	33	J245301	XIII	39	J252332ET	XI	21	J28190	XIII	56
J243910	XIII	33	J245302	XIII	39	J252333E	XI	21	J28200	XIII	56
J243920	XIII	33	J245303	XIII	39	J252333ET	XI	21	J28210	XIII	56
J243990	XIII	33	J245304	XIII	39	J252334E	XI	21	J28220	XIII	56
J24400	XIII	33	J251811E	XI	20	J252334ET	XI	21	J28230	XIII	56
J24405	XIII	33	J251811ET	XI	20	J252335E	XI	21	J282310	XIII	56
J24410	XIII	33	J251812E	XI	20	J252335ET	XI	21	J28232	XIII	56
J244130	XIII	33	J251812ET	XI	20	J252811E	XI	20	J28234	XIII	56
J244140	XIII	33	J251813E	XI	20	J252811ET	XI	20	J28236	XIII	56
J24415	XIII	33	J251813ET	XI	20	J252812E	XI	20	J28240	XIII	56
J24420	XIII	33	J251814E	XI	20	J252812ET	XI	20	J28250	XIII	56
J24425	XIII	33	J251814ET	XI	20	J252813E	XI	20	J28260	XIII	56
J244300	XIII	33	J251815E	XI	20	J252813ET	XI	20	J28270	XIII	56
J244310	XIII	33	J251815ET	XI	20	J252814E	XI	20	J28280	XIII	56
J244320	XIII	33	J251831E	XI	21	J252814ET	XI	20	J28290	XIII	56
J244330	XIII	34	J251831ET	XI	21	J252815E	XI	20	J28300	XIII	56
J244340	XIII	34	J251832E	XI	21	J252815ET	XI	20	J283001	XIII	57
J244350	XIII	34	J251832ET	XI	21	J252831E	XI	21	J283002	XIII	57
J244360	XIII	34	J251833E	XI	21	J252831ET	XI	21	J283003	XIII	57
J244370	XIII	34	J251833ET	XI	21	J252832E	XI	21	J283004	XIII	57
J244400	XIII	51	J251834E	XI	21	J252832ET	XI	21	J283005	XIII	57
J244410	XIII	51	J251834ET	XI	21	J252833E	XI	21	J283006	XIII	57
J244650	XIII	84	J251835E	XI	21	J252833ET	XI	21	J283007	XIII	57
J24466	XIII	84	J251835ET	XI	21	J252834E	XI	21	J283008	XIII	57
J244670	XIII	84	J252011E	XI	20	J252834ET	XI	21	J283009	XIII	57
J244680	XIII	84	J252011ET	XI	20	J252835E	XI	21	J283010	XIII	57
J244705	XIII	84	J252012E	XI	20	J252835ET	XI	21	J283021	XIII	57

Index numérique - Numerical Index - Índice numérico

Références References Referencias	Chapitre Chapter Capítulo	Page Page Página	Références References Referencias	Chapitre Chapter Capítulo	Page Page Página	Références References Referencias	Chapitre Chapter Capítulo	Page Page Página	Références References Referencias	Chapitre Chapter Capítulo	Page Page Página
J283022	XIII	57	J283407	XIII	59	J284050	XIII	52	J320617	XII	38
J283023	XIII	57	J283408	XIII	59	J284060	XIII	52	J320618	XII	38
J283024	XIII	57	J283410	XIII	59	J284070	XIII	52		XIII	68
J283025	XIII	57	J283411	XIII	59	J284080	XIII	52	J320623	XIII	68
J283026	XIII	57	J283412	XIII	59	J28412	XIII	52	J320624	XIII	68
J283027	XIII	57	J283413	XIII	59	J284130	XIII	52	J320625	XIII	68
J283100	XIII	58	J283414	XIII	59	J28414	XIII	52	J320626	XIII	68
J283101	XIII	58	J283415	XIII	59	J284150	XIII	52	J320627	XIII	68
J283102	XIII	58	J283416	XIII	59	J284160	XIII	52	J320634	XIII	68
J283103	XIII	58	J283417	XIII	59	J284170	XIII	52	J320636	XIII	68
J283104	XIII	58	J283418	XIII	59	J284180	XIII	52	J320644	XIII	71
J283105	XIII	58	J283420	XIII	59	J28420	XIII	52	J320646	XIII	71
J283106	XIII	58	J283421	XIII	59	J28425	XIII	52	J320648	XIII	71
J283107	XIII	58	J283422	XIII	59	J284260	XIII	53	J320650	XIII	71
J283108	XIII	58	J283423	XIII	59	J284274	XIII	53	J320652	XIII	71
J283110	XIII	58	J283424	XIII	59	J284275	XIII	53	J320654	XIII	71
J283120	XIII	58	J283425	XIII	59	J284276	XIII	53	J320670	XIII	71
J283200	XIII	62	J283426	XIII	59	J284279	XIII	53	J320671	XIII	71
J283201	XIII	62	J283427	XIII	59	J284280	XIII	53	J320672	XIII	71
J283202	XIII	62	J283428	XIII	59	J284281	XIII	53	J320673	XIII	71
J283203	XIII	62	J283450	XIII	56	J284290	XIII	53	J320674	XIII	71
J283204	XIII	62	J28350	XIII	65	J284300	XIII	54	J320675	XIII	71
J283205	XIII	62	J28360	XIII	65	J284310	XIII	54	J320676	XIII	71
J283206	XIII	62	J28370	XIII	65	J284320	XIII	54	J320680	XIII	71
J283207	XIII	62	J283790	XIII	60	J284330	XIII	54	J320681	XIII	71
J283208	XIII	62	J283791	XIII	60	J284340	XIII	54	J320682	XIII	71
J283210	XIII	62	J283792	XIII	60	J284350	XIII	54	J320683	XIII	71
J283211	XIII	62	J283800	XIII	60	J320004	XIII	69	J320684	XIII	71
J283212	XIII	62	J283801	XIII	60	J320006	XIII	69	J320685	XIII	71
J283213	XIII	62	J283802	XIII	60	J320008	XIII	69	J320686	XIII	71
J283214	XIII	62	J283803	XIII	60	J320010	XIII	69	J320710	XIII	75
J283215	XIII	62	J283810	XIII	61	J320012	XIII	69	J320715	XIII	75
J283216	XIII	62	J283811	XIII	61	J320014	XIII	69	J320720	XIII	75
J283217	XIII	62	J283812	XIII	61	J320016	XIII	69	J320725	XIII	75
J283218	XIII	62	J283813	XIII	61	J320024	XIII	69	J320730	XIII	75
J283220	XIII	62	J283814	XIII	61	J320026	XIII	69	J320735	XIII	75
J283221	XIII	62	J283820	XIII	61	J320028	XIII	69	J320740	XIII	75
J283222	XIII	62	J283821	XIII	61	J320030	XIII	69	J320762	XIII	75
J283223	XIII	62	J283822	XIII	61	J320032	XIII	69	J320766	XIII	75
J283224	XIII	62	J283823	XIII	61	J320034	XIII	69	J320768	XIII	75
J283225	XIII	62	J283830	XIII	61	J320036	XIII	69	J320800	XIII	76
J283226	XIII	62	J283831	XIII	61	J32010	XIII	70	J320802	XIII	76
J283227	XIII	62	J283832	XIII	61	J32020	XIII	70	J320803	XIII	76
J283228	XIII	62	J283833	XIII	61	J32030	XIII	70	J320804	XIII	76
J283233	XIII	63	J283840	XIII	64	J32040	XIII	70	J320805	XIII	76
J283234	XIII	63	J283841	XIII	64	J32050	XIII	70	J320810	XIII	76
J283235	XIII	63	J283842	XIII	64	J32060	XIII	70	J320812	XIII	76
J283300	XIII	63	J283850	XIII	64	J320612	XII	38	J320813	XIII	76
J283310	XIII	63	J283851	XIII	64		XIII	68	J320814	XIII	76
J283320	XIII	63	J283852	XIII	64	J320613	XII	38	J320815	XIII	76
J283400	XIII	59	J283860	XIII	64		XIII	68	J320990	XIII	76
J283401	XIII	59	J283861	XIII	64	J320614	XII	38	J320991	XIII	76
J283402	XIII	59	J283862	XIII	64		XIII	68	J320992	XIII	76
J283403	XIII	59	J28400	XIII	65	J320615	XII	38	J320993	XIII	76
J283404	XIII	59	J28402	XIII	52		XIII	68	J32100	XIII	76
J283405	XIII	59	J284030	XIII	52	J320616	XII	38	J32110	XIII	76
J283406	XIII	59	J28404	XIII	52		XIII	68	J321101	XIII	76

Index numérique - Numerical Index - Índice numérico

Références References Referencias	Chapitre Chapter Capítulo	Page Page Página	Références References Referencias	Chapitre Chapter Capítulo	Page Page Página	Références References Referencias	Chapitre Chapter Capítulo	Page Page Página	Références References Referencias	Chapitre Chapter Capítulo	Page Page Página
J321102	XIII	76	J325423	XIII	66	J326907	XIII	74	J36042	XIII	78
J32140	XIII	76	J325424	XIII	66	J326908	XIII	74	J36044	XIII	78
J32150	XIII	76	J325425	XIII	66	J326909	XIII	74	J36060	XIII	78
J32160	XIII	76	J325426	XIII	66	J326910	XIII	73	J36070	XIII	78
J32170	XIII	76	J325427	XIII	66	J326912	XIII	73	J36080	XIII	78
J32190	XIII	76	J325428	XIII	66	J326915	XIII	73	J360904	XIII	69
J32200	XIII	76	J325429	XIII	66	J326920	XIII	73	J360906	XIII	69
J32210	XIII	76	J325430	XIII	66	J326925	XIII	73	J360908	XIII	69
J32220	XIII	76	J325450	XIII	66	J327006	XIII	73	J360910	XIII	69
J32235	XIII	74	J325455	XIII	66	J327008	XIII	73	J360912	XIII	69
J32240	XIII	73	J32550	XIII	66	J327010	XIII	73	J360914	XIII	69
J32250	XIII	73	J32555	XIII	66	J327012	XIII	73	J360916	XIII	69
J32260	XIII	73	J32560	XIII	66	J327015	XIII	73	J36100	XIII	70
J32270	XIII	73	J32565	XIII	66	J327020	XIII	73	J36110	XIII	70
J32280	XIII	73	J32570	XIII	66	J327025	XIII	73	J36120	XIII	70
J32290	XIII	73	J32580	XIII	66	J327030	XIII	73	J36130	XIII	70
J32300	XIII	73	J32590	XIII	66	J327106	XIII	73	J36140	XIII	70
J32310	XIII	73	J32600	XIII	66	J327108	XIII	73	J36150	XIII	70
J32320	XIII	73	J32610	XIII	66	J327110	XIII	73	J361523	XIII	68
J32330	XIII	73	J32620	XIII	66	J327112	XIII	73	J361524	XIII	68
J32340	XIII	73	J32621	XIII	67	J327115	XIII	73	J361525	XIII	68
J32350	XIII	73	J32622	XIII	67	J327120	XIII	73	J361526	XIII	68
J32360	XIII	73	J32623	XIII	67	J327125	XIII	73	J361527	XIII	68
J32370	XIII	73	J32624	XIII	67	J327130	XIII	73	J361534	XIII	68
J32380	XIII	73	J32625	XIII	67	J327206	XIII	73	J361536	XIII	68
J32390	XIII	73	J326260	XIII	67	J327208	XIII	73	J361544	XIII	71
J32400	XIII	70	J32627	XIII	77	J327210	XIII	73	J361546	XIII	71
J32410	XIII	70	J32628	XIII	77	J327212	XIII	73	J361548	XIII	71
J32420	XIII	70	J32629	XIII	77	J327215	XIII	73	J361550	XIII	71
J32430	XIII	75	J32630	XIII	77	J327220	XIII	73	J361552	XIII	71
J32440	XIII	75	J32640	XIII	77	J327225	XIII	73	J361554	XIII	71
J32450	XIII	75	J32650	XIII	77	J327230	XIII	73	J36180	XIII	73
J32460	XIII	75	J32660	XIII	77	J328006	XIII	76	J36190	XIII	73
J324620	XIII	66	J32665	XIII	77	J328008	XIII	76	J36200	XIII	73
J324621	XIII	66	J32675	XIII	65	J328010	XIII	76	J36210	XIII	73
J324622	XIII	66	J32678	XIII	67	J328012	XIII	76	J36220	XIII	73
J324623	XIII	66	J32682	XIII	67	J328015	XIII	76	J36230	XIII	73
J324624	XIII	66	J32684	XIII	67	J328020	XIII	76	J36240	XIII	73
J324625	XIII	66	J32686	XIII	67	J328025	XIII	76	J36250	XIII	73
J324626	XIII	66	J32688	XIII	67	J328030	XIII	76	J36260	XIII	73
J324627	XIII	66	J326890	XIII	74	J328904	XIII	81	J36270	XIII	73
J32465	XIII	66	J326891	XIII	74	J328906	XIII	81	J36280	XIII	73
J324658	XIII	66	J326892	XIII	74	J328908	XIII	81	J36290	XIII	73
J32470	XIII	66	J326893	XIII	74	J328910	XIII	81	J36300	XIII	73
J324750	XIII	66	J326894	XIII	74	J328912	XIII	81	J36310	XIII	73
J32480	XIII	66	J326895	XIII	74	J329005	XIII	81	J36320	XIII	73
J324850	XIII	66	J326896	XIII	74	J329007	XIII	81	J36330	XIII	73
J32490	XIII	66	J326897	XIII	74	J329010	XIII	81	J363310	XIII	72
J32500	XIII	66	J326898	XIII	74	J329015	XIII	81	J363311	XIII	72
J32510	XIII	66	J326899	XIII	74	J329020	XIII	81	J363312	XIII	72
J32520	XIII	66	J326900	XIII	74	J329025	XIII	81	J363313	XIII	72
J32530	XIII	66	J326901	XIII	74	J329030	XIII	81	J363314	XIII	72
J32540	XIII	66	J326902	XIII	74	J329120	XIII	82	J363315	XIII	72
J325418	XIII	66	J326903	XIII	74	J329130	XIII	82	J363316	XIII	72
J325420	XIII	66	J326904	XIII	74	J36020	XIII	78	J363320	XIII	72
J325421	XIII	66	J326905	XIII	74	J36030	XIII	78	J363321	XIII	72
J325422	XIII	66	J326906	XIII	74	J36040	XIII	78	J363322	XIII	72

Index numérique - Numerical Index - Índice numérico

Références Referencias Referencias	Chapitre Chapter Capítulo	Page Page Página	Références Referencias Referencias	Chapitre Chapter Capítulo	Page Page Página	Références Referencias Referencias	Chapitre Chapter Capítulo	Page Page Página	Références Referencias Referencias	Chapitre Chapter Capítulo	Page Page Página
J363323	XIII	72	J369030	XIII	81	J44055	XIII	91	J52072	VII	133
J363324	XIII	72	J369105	XIII	82	J44060	XIII	91	J52074	VII	133
J363325	XIII	72	J369110	XIII	82	J44065	XIII	91	J52076	VII	134
J363326	XIII	72	J369205	XIII	82	J44066	XIII	91	J520770	VII	133
J36335	XIII	78	J369210	XIII	82	J44068	XIII	91	J52078	VII	134
J36340	XIII	78	J369215	XIII	82	J44070	XIII	91	J520785	VII	134
J36345	XIII	78	J369305	XIII	82	J44071	XIII	91	J52082	VII	134
J36350	XIII	77	J369310	XIII	82	J440723	XIII	93	J520830	VII	134
J36360	XIII	77	J369315	XIII	82	J440724	XIII	93	J52084	VII	135
J36370	XIII	77	J369406	XIII	83	J440725	XIII	93	J52086	VII	136
J36380	XIII	77	J369408	XIII	83	J440726	XIII	93	J52088	VII	136
J36390	XIII	77	J369411	XIII	83	J440728	XIII	93	J52092	VII	135
J36400	XIII	77	J369413	XIII	83	J440733	XIII	93	J520925	VII	137
J36410	XIII	77	J369416	XIII	83	J440734	XIII	93	J520926	VII	137
J36420	XIII	77	J369425	XIII	83	J440735	XIII	93	J520930	VII	137
J36430	XIII	77	J369429	XIII	83	J440736	XIII	93	J520935	VII	138
J36440	XIII	77	J369440	XIII	83	J440738	XIII	93	J520936	VII	138
J36450	XIII	77	J400010	XIII	85	J44075	XIII	92	J520938	VII	132
J36460	XIII	77	J400020	XIII	85	J44085	XIII	92	J520939	VII	133
J364714	XIII	79	J40010	XIII	85	J44100	XIII	92	J52094	VII	132
J364716	XIII	79	J40020	XIII	85	J44105	XIII	92	J52096	VII	132
J364718	XIII	79	J40025	XIII	85	J44110	XIII	92	J52098	VII	132
J364720	XIII	79	J40030	XIII	85	J441113	XIII	93	J520990	VII	132
J364814	XIII	79	J40040	XIII	86	J441114	XIII	93	J521001	VII	141
J364816	XIII	79	J40045	XIII	86	J441115	XIII	93	J521002	VII	141
J364818	XIII	79	J40050	XIII	86	J44115	XIII	92	J521003	VII	141
J364820	XIII	79	J40055	XIII	86	J44116	XIII	92	J521004	VII	141
J364914	XIII	79	J40060	XIII	86	J44117	XIII	92	J521010	VII	141
J364916	XIII	79	J40070	XIII	86	J441200	XIII	93	J521015	VII	141
J364918	XIII	79	J40075	XIII	86	J44121	XIII	94	J521020	VII	141
J364920	XIII	79	J40080	XIII	86	J44122	XIII	94	J521030	VII	142
J36560	XIII	76	J40090	XIII	86	J44123	XIII	94	J521035	VII	142
J36570	XIII	76	J400950	XIII	87	J442008	XIII	94	J521040	VII	142
J36580	XIII	76	J401000	XIII	89	J442010	XIII	94	J52130	VII	145
J36590	XIII	76	J401180	XIII	90	J442012	XIII	94	J521400	VII	145
J36600	XIII	76	J401190	XIII	90	J48020	XIII	95	J521410	VII	145
J366170	XIII	80	J40120	XIII	90	J48030	XIII	95	J52150	VII	145
J366180	XIII	80	J401300	XIII	90	J48040	XIII	95	J521505	VII	145
J366190	XIII	80	J401301	XIII	90	J48050	XIII	95	J521600	VII	145
J36620	XIII	80	J401302	XIII	90	J520050	VII	143	J521610	VII	145
J36625	XIII	80	J401303	XIII	90	J52010	VII	143	J52170	VII	146
J36635	XIII	80	J401400	XIII	89	J52020	VII	143	J521750	VII	146
J36650	XIII	65	J401405	XIII	89	J520230	VII	139	J52180	VII	117
J36700	XIII	80	J401500	XIII	87	J520231	VII	139	J521850	VII	110
J36705	XIII	80	J401505	XIII	87	J520240	VII	140	J521860	VII	110
J36710	XIII	80	J401600	XIII	87	J520260	VII	140	J521870	VII	110
J368904	XIII	81	J401700	XIII	88	J520280	VII	140	J52210	VII	144
J368906	XIII	81	J401800	XIII	88	J52030	VII	140	J52220	VII	144
J368908	XIII	81	J440070	XIII	91	J520320	VII	140	J52230	VII	144
J368910	XIII	81	J440075	XIII	91	J520340	VII	140	J522400	VII	144
J368912	XIII	81	J44010	XIII	91	J52040	VII	140	J560350	XIII	96
J369005	XIII	81	J44020	XIII	91	J520420	VII	140	J56040	XIII	96
J369007	XIII	81	J44032	XIII	91	J520440	VII	140	J56050	XIII	96
J369010	XIII	81	J44035	XIII	91	J520450	VII	140	J56055	XIII	96
J369015	XIII	81	J44040	XIII	91	J52050	VII	139	J56070	XIII	96
J369020	XIII	81	J44045	XIII	91	J52060	VII	139	J561200	XIII	96
J369025	XIII	81	J44050	XIII	91	J52070	VII	139	J64020	XIII	97

Index numérique - Numerical Index - Índice numérico

Références References Referencias	Chapitre Chapter Capitulo	Page Page Página	Références References Referencias	Chapitre Chapter Capitulo	Page Page Página	Références References Referencias	Chapitre Chapter Capitulo	Page Page Página	Références References Referencias	Chapitre Chapter Capitulo	Page Page Página
J64030	XIII	97	J644950	XIII	104	J681605	XIII	122	J72370	XIII	129
J64040	XIII	97	J644960	XIII	104	J681610	XIII	123	J72380	XIII	129
J64060	XIII	97	J644970	XIII	104	J681615	XIII	123	J72390	XIII	129
J64070	XIII	97	J644980	XIII	104	J681620	XIII	123	J72400	XIII	127
J64080	XIII	97	J644984	XIII	104	J681630	XIII	123	J72405	XIII	129
J64090	XIII	97	J644986	XIII	104	J68170	XIII	121	J72410	XIII	129
J64100	XIII	97	J644990	XIII	102	J68180	XIII	121	J72420	XIII	129
J64120	XIII	97	J644995	XIII	102	J681900	XIII	121	J72430	XIII	129
J64130	XIII	97	J644996	XIII	102	J68210	XIII	122	J72440	XIII	129
J64150	XIII	98	J645000	XIII	105	J68220	XIII	122	J72460	XIII	130
J64160	XIII	98	J645010	XIII	105	J68230	XIII	122	J72470	XIII	130
J64190	XIII	106	J645100	XIII	106	J68240	XIII	122	J72480	XIII	130
J64192	XIII	106	J645110	XIII	105	J68250	XIII	125	J72490	XIII	130
J64200	XIII	111	J645120	XIII	105	J68260	XIII	125	J72500	XIII	130
J64210	XIII	111	J645200	XIII	102	J68270	XIII	125	J72510	XIII	130
J64220	XIII	111	J645205	XIII	102	J68275	XIII	118	J725200	XIII	132
J64230	XIII	111	J645210	XIII	105	J68280	XIII	118	J725201	XIII	132
J64240	XIII	111	J645215	XIII	106	J72010	XIII	127	J725202	XIII	132
J64250	XIII	111	J645220	XIII	107	J72020	XIII	133	J725203	XIII	132
J64254	XIII	113	J645230	XIII	107	J72030	XIII	133	J725204	XIII	132
J64256	XIII	113	J645235	XIII	108	J72040	XIII	133	J725211	XIII	131
J642570	XIII	113	J645240	XIII	108	J72050	XIII	133	J725212	XIII	131
J64260	XIII	98	J645245	XIII	108	J72060	XIII	133	J725213	XIII	131
J64270	XIII	100	J645250	XIII	110	J72070	XIII	133	J725221	XIII	131
J64280	XIII	114	J645251	XIII	110	J72090	XIII	140	J725222	XIII	131
J64290	XIII	99	J645300	XIII	115	J72100	XIII	139	J725223	XIII	131
J64310	XIII	99	J645310	XIII	115	J721010	XIII	139	J72540	XIII	135
J64330	XIII	99	J645315	XIII	115	J721020	XIII	139	J72550	XIII	140
J64340	XIII	99	J68010	XIII	118	J72110	XIII	140	J72560	XIII	140
J64350	XIII	99	J68012	XIII	118	J72120	XIII	136	J72570	XIII	140
J64370	XIII	114	J68015	XIII	118	J72130	XIII	136	J72575	XIII	126
J64380	XIII	99	J68022	XIII	116	J72140	XIII	136	J725800	XIII	126
J643810	XIII	100	J68024	XIII	116	J72150	XIII	136	J725805	XIII	126
J64384	XIII	109	J68026	XIII	116	J72160	XIII	136	J725810	XIII	126
J643850	XIII	109	J68028	XIII	116	J72170	XIII	136	J725850	XIII	126
J64386	XIII	109	J68030	XIII	116	J72180	XIII	138	J725860	XIII	137
J64390	XIII	109	J68040	XIII	116	J721810	XIII	138	J725870	XIII	137
J643950	XIII	109	J68050	XIII	116	J721820	XIII	138	J725880	XIII	137
J64400	XIII	101	J68060	XIII	116	J72190	XIII	127	J725885	XIII	137
J644005	XIII	101	J68062	XIII	116	J721901	XIII	127	J725890	XIII	137
J644010	XIII	101	J68064	XIII	116	J72195	XIII	142	J72590	XIII	128
J64410	XIII	109	J68066	XIII	116	J72200	XIII	134	J72595	XIII	128
J64412	XIII	112	J68068	XIII	116	J72210	XIII	134	J72600	XIII	128
J64414	XIII	112	J680700	XIII	117	J72220	XIII	134	J72605	XIII	128
J64416	XIII	112	J680710	XIII	117	J72230	XIII	134	J72610	XIII	128
J64418	XIII	112	J680715	XIII	117	J72240	XIII	134	J72612	XIII	128
J64422	XIII	112	J680720	XIII	117	J72250	XIII	134	J72615	XIII	128
J644230	XIII	112	J68090	XIII	119	J72260	XIII	134	J72620	XIII	128
J64480	XIII	109	J68100	XIII	119	J72270	XIII	134	J72700	III	86
J644830	XIII	110	J681090	XIII	120	J72280	XIII	134	J72705	XIII	142
J644850	XIII	110	J68110	XIII	120	J72310	XIII	135	J727100	XIII	142
J644870	XIII	112	J681190	XIII	119	J72320	XIII	135	J727110	XIII	142
J644875	XIII	103	J68120	XIII	119	J72330	XIII	135	J727120	XIII	142
J644880	XIII	103	J68130	XIII	121	J72340	XIII	135	J727500	XIII	141
J644885	XIII	103	J68150	XIII	121	J72350	XIII	127	J727550	XIII	141
J644890	XIII	103	J681600	XIII	124	J72355	XIII	129	J727560	XIII	141
J64490	XIII	103	J681601	XIII	124	J72360	XIII	129	J727570	XIII	141

Index numérique - Numerical Index - Índice numérico

Références Referencias Referencias	Chapitre Chapter Capítulo	Page Page Página	Références Referencias Referencias	Chapitre Chapter Capítulo	Page Page Página	Références Referencias Referencias	Chapitre Chapter Capítulo	Page Page Página	Références Referencias Referencias	Chapitre Chapter Capítulo	Page Page Página
J727580	XIII	141	J759061	XIV	28	J80370	XIII	155	J821043	XIII	146
J727590	XIII	141	J759062	XIV	28	J80390	XIII	155	J821044	XIII	146
J731100	XIV	29	J759063	XIV	28	J80420	XIII	155	J84010	XIII	149
J731200	XIV	29	J759100	XIV	28	J80430	XIII	156	J84020	XIII	149
J731300	XIV	29	J759105	XIV	28	J80435	XIII	156	J84030	XIII	149
J731400	XIV	29	J759110	XIV	28	J80440	XIII	156	J84040	XIII	149
J732000	XIII	143	J759115	XIV	28	J80445	XIII	156	J84070	XIII	150
J732005	XIII	143	J76020	XV	23	J80450	XIII	156	J84110	XIII	150
J732010	XIII	143	J760250	XV	23	J804510	XIII	144	J84120	XIII	150
J732020	XIII	143	J76030	XV	23	J804520	XIII	144	J84130	XIII	150
J733000	XIII	143	J760310	XV	23	J804530	XIII	144	J90030	XIII	158
J733050	XIII	143	J76050	XV	21	J80455	XIII	156	J90040	XIII	158
J733060	XIII	143	J76060	XV	21	J80460	XIII	144	J90050	XIII	158
J756900	XIV	25	J76070	XV	21	J80470	XIII	144	J90060	XIII	159
J757410	XIV	27	J76080	XV	24	J80480	XIII	144	J90065	XIII	159
J757420	XIV	26	J76090	XV	24	J804850	XIII	144	J90070	XIII	159
J757430	XIV	26	J76100	XV	24	J804860	XIII	144	J90080	XIII	158
J757490	XIV	31	J76110	XV	24	J804870	XIII	144	J90090	XIII	158
J757500	XIV	31	J76120	XV	24	J804880	XIII	144	J901010	XIII	158
J757506	XIV	30	J76128	XV	23	J804885	XIII	144	J90110	XIII	160
J757508	XIV	30	J76130	XV	23	J80495	XIII	157	J90120	XIII	160
J757510	XIV	30	J76140	III	85	J804960	XIII	157	J90130	XIII	160
J757520	XIV	30		XV	22	J804970	XIII	157	J90140	XIII	160
J757900	XIV	26	J761410	III	85	J80500	XIII	156	J90150	XIII	160
J758000	XIV	26		XV	22	J805042	XIII	145	J90220	XIII	161
J758010	XIV	32	J761450	XV	22	J805043	XIII	145	J90230	XIII	161
J758040	XIV	32	J761500	XV	22	J805044	XIII	145	J90240	XIII	161
J758042	XIV	32	J80010	XIII	151	J805045	XIII	145	J90250	XIII	161
J758045	XIV	32	J80015	XIII	151	J805046	XIII	145	J904000	XIII	162
J758050	XIV	32	J80020	XIII	151	J805048	XIII	145	J904010	XIII	162
J758060	XIV	32	J80030	XIII	151	J805049	XIII	145	J904020	XIII	162
J758200	XIV	31	J800400	XIII	151	J805050	XIII	145	J94020	XIV	40
J758300	XIV	31	J800405	XIII	151	J80510	XIII	145	J940250	XIV	7
J758400	XIV	33	J800500	XIII	151	J80520	XIII	145	J94030	XIV	8
J758401	XIV	34	J80075	XIII	152	J80530	XIII	145	J940310	XIV	8
J758402	XIV	34	J80080	XIII	152	J805310	XIII	145	J94035	XIV	8, 9
J758403	XIV	33	J80090	XIII	152	J805352	XIII	145	J940400	XIV	8
J758404	XIV	36	J800950	XIII	152	J805354	XIII	145	J940410	XIV	8
J758405	XIV	36	J80100	XIII	152	J805356	XIII	145	J94050	XIV	9
J758406	XIV	35	J80110	XIII	152	J80540	XIII	145	J94055	XIV	9
J758407	XIV	35	J801110	XIII	152	J80550	XIII	145	J94150	XIV	37
J758410	XIV	33, 34	J80120	XIII	153	J82010	XIII	147	J94170	XIV	37
J758416	XIV	35	J80130	XIII	153	J82020	XIII	147	J94180	XIV	37
J758420	XIV	33	J80140	XIII	153	J82030	XIII	148	J94190	XIV	37
J758421	XIV	34	J801450	XIII	154	J82040	XIII	148	J94210	XIV	7, 9
J758423	XIV	33	J80150	XIII	154	J82050	XIII	148	M002200	XIV	38
J758424	XIV	36	J801550	XIII	154	J821000	XIII	146	M00250	XIV	40
J758425	XIV	36	J80170	III	86	J821010	XIII	146	M00300	XIV	42
J758426	XIV	35	J80200	XIII	155	J821012	XIII	146	M00301	XIV	42
J758430	XIV	28	J80210	XIII	149	J821013	XIII	146	M00302	XIV	42
J758431	XIV	28	J80220	XIII	157	J821014	XIII	146	M00303	XIV	42
J759030	XIV	27	J80230	XIII	157	J821019	XIII	146	M003890	XIV	47
J759040	XIV	27	J80270	XIII	156	J821020	XIII	146	M00390	XIV	47
J759041	XIV	27	J80280	XIII	156	J821030	XIII	146	M00391	XIV	47
J759042	XIV	27	J80290	XIII	156	J821040	XIII	146	M00400	XIV	47
J759050	XIV	27	J80300	XIII	156	J821041	XIII	146	M004001	XIV	47
J759060	XIV	28	J80305	XIII	156	J821042	XIII	146	M004510	XIV	5

Index numérique - Numerical Index - Índice numérico

Références References Referencias	Chapitre Chapter Capitulo	Page Page Página	Références References Referencias	Chapitre Chapter Capitulo	Page Page Página	Références References Referencias	Chapitre Chapter Capitulo	Page Page Página	Références References Referencias	Chapitre Chapter Capitulo	Page Page Página
M004511	XIV	5	M01176	XIV	12	M02241	XIV	19	M03362	XIV	48
M004512	XIV	5	M01177	XIV	12	M02270	XIV	24	M03380	XIV	14
M004513	XIV	5	M01200	XIV	13	M02271	XIV	24	M03381	XIV	14
M004514	XIV	5	M01210	XIV	13	M02272	XIV	24	M03382	XIV	14
M004515	XIV	5	M01220	XIV	13	M02273	XIV	24	M03390	XIV	14
M004516	XIV	5	M01230	XIV	13	M02274	XIV	24	M03391	XIV	14
M004517	XIV	5	M01235	XIV	13	M02275	XIV	24	M03392	XIV	15
M004530	XIV	5	M01240	XIV	13	M022760	XIV	24	M03393	XIV	14
M004531	XIV	5	M01241	XIV	13	M022770	XIV	24	M03400	XIV	14
M004532	XIV	5	M01250	XIV	20	M022780	XIV	24	M034010	XIV	14
M004533	XIV	5	M01251	XIV	20	M022790	XIV	24	M03410	XIV	15
M004534	XIV	5	M01252	XIV	20	M03001	XIV	46	M03420	XIV	15
M004535	XIV	5	M01253	XIV	20	M030030	XIV	46	M03422	XIV	15
M004536	XIV	5	M01260	XIV	23	M03020	XIV	10	M03430	XIV	15
M004537	XIV	5	M01270	XIV	23	M03022	XIV	10	M03431	XIV	15
M004538	XIV	5	M012915	XIV	13	M03024	XIV	10	M03432	XIV	15
M004539	XIV	5	M012920	XIV	13	M03030	XIV	18	M03433	XIV	15
M004540	XIV	5	M012925	XIV	13	M03031	XIV	18	M03436	XIV	15
M004541	XIV	5	M012930	XIV	13	M03032	XIV	18	M03437	XIV	15
M004542	XIV	5	M012940	XIV	13	M03033	XIV	18	M03438	XIV	15
M004543	XIV	5	M012950	XIV	13	M03034	XIV	19	M03440	XIV	18
M00460	XIV	6	M012960	XIV	13	M03035	XIV	19	M03450	XIV	16
M00461	XIV	6	M02000	XIV	41	M03036	XIV	19	M03460	XIV	16
M00462	XIV	6	M02001	XIV	41	M03037	XIV	19	M03470	XIV	16
M004625	XIV	6	M02002	XIV	41	M03040	XIV	46	M03480	XIV	16
M00463	XIV	6	M02003	XIV	41	M03050	XIV	45	M03490	XIV	16
M00464	XIV	6	M02010	XIV	41	M03060	XIV	12	M03500	XIV	23
M00490	XIV	10	M02020	XIV	41	M03080	XIV	31	M03510	XIV	23
M00493	XIV	10	M02021	XIV	41	M03110	XIV	21	M035150	XIV	23
M006050	XIV	37	M020220	XIV	41	M03120	XIV	21	M035160	XIV	23
M006055	XIV	37	M020231	XIV	41	M03125	XIV	21	M03520	XIV	20
M006080	XIV	37	M020232	XIV	41	M03126	XIV	21	M03530	XIV	20
M01000	XIV	42	M02030	XIV	43	M03130	XIV	22	M03600	XIV	25
M01040	XIV	23	M02040	XIV	43	M03135	XIV	22	M036010	XIV	25
M01051	XIV	20	M02050	XIV	43	M03170	XIV	25	M03700	XIV	52
M01052	XIV	20	M02070	XIV	45	M03200	XIV	39	M037050	XIV	52
M01060	XIV	49	M02071	XIV	45	M03201	XIV	39	M03710	XIV	52
M01070	XIV	49	M02072	XIV	45	M03202	XIV	39	M03745	XIV	52
M01080	XIV	49	M02090	XIV	44	M03203	XIV	39	M03770	XIV	52
M01110	XIV	7	M02091	XIV	44	M03210	XIV	42	T90090	XV	25
M01111	XIV	7	M02092	XIV	44	M03211	XIV	42	T90095	XV	25
M01112	XIV	7	M02100	XIV	50	M03212	XIV	42	T90098	XV	25
M01120	XIV	11	M02110	XIV	50	M03213	XIV	42	T90100	XV	25
M01122	XIV	11	M02120	XIV	50	M03220	XIV	43	T90110	XV	25
M01124	XIV	11	M02122	XIV	51	M03240	XIV	39	T90120	XV	25
M01126	XIV	11	M02124	XIV	51	M03241	XIV	39	T90130	XV	25
M01128	XIV	11	M02126	XIV	51	M03250	XIV	39	T90140	XV	25
M01130	XIV	11	M02130	XIV	17	M03280	XIV	39	T90141	XV	25
M01132	XIV	12	M02140	XIV	17	M03290	XIV	39	T90143	XV	25
M01134	XIV	12	M02150	XIV	19	M03291	XIV	39	T90145	XV	25
M01136	XIV	12	M02170	XIV	40	M03320	XIV	44	V025650	XV	27
M01138	XIV	12	M02190	XIV	17, 40	M03321	XIV	44	V02570	XV	27
M01140	XIV	12	M02200	XIV	11	M03355	XIV	48	V02575	XV	27
M01150	XIV	12	M02215	XIV	17	M03356	XIV	48	V02580	XV	27
M01160	XIV	12	M02230	XIV	17	M03357	XIV	48	V02610	XV	28
M01170	XIV	12	M02235	XIV	17	M03360	XIV	48	V02620	XV	28
M01175	XIV	12	M02240	XIV	19	M03361	XIV	48	V02630	XV	28

Index numérique - Numerical Index - Índice numérico

Références Referencias Referencias	Chapitre Chapter Capitulo	Page Page Página	Références Referencias Referencias	Chapitre Chapter Capitulo	Page Page Página	Références Referencias Referencias	Chapitre Chapter Capitulo	Page Page Página	Références Referencias Referencias	Chapitre Chapter Capitulo	Page Page Página
V02640	XV	28									
V02650	XV	28									
V02660	XV	28									
V028000	XV	27									
V028001	XV	27									
V029000	XV	29									
V029001	XV	29									
V029002	XV	29									
V029003	XV	29									
V029004	XV	29									
V029005	XV	29									
V029006	XV	29									
V029100	XV	29									
V029101	XV	29									
V029102	XV	29									
V029103	XV	29									
V029200	XV	29									
V029210	XV	29									
V029300	XV	30									
V029350	XV	30									
V029400	XV	30									
V029450	XV	29									
V029451	XV	29									
V029452	XV	29									
V029500	XV	30									
V029550	XV	30									
V036000	XV	28									
V78071	XV	33									
V78100	XV	32									
V78110	XV	32									
V781150	XV	32									
V78130	XV	32									
V78170	XV	32									
V782000	XV	32									
V78301	XV	33									
V78321	XV	33									
V784000	XV	33									



		Chapitre	Page
AACHEN	Spatules	XI	5
ABADIE	Écarteurs	VII	91
Abaisse langue		XV	6-7
ABOULKER	Écarteurs	VII	11
	O.R.L. dilateurs	XII	12
	Pincers gouges	XIII	100
	Rugines et dissecteurs	XIII	32
ABRAHAM	O.R.L. couteaux spatules	XII	25
ADLERKREUTZ	Pincers à dissection Prestige	II	50
	Pincers à dissection spéciales	II	16
ADSON	Crochets	XIII	24
	Écarteurs	VII	124, 126
	Instrumentation de service	XV	17
	Pincers à dissection délicates	II	22
	Pincers à dissection mors tungstène	II	47
	Pincers gouges	XIII	104
	Pincers hémostatiques	IV	35
	Porte-aiguilles	VI	10
	Rugines	XIII	38
ADSON ATRAUMA	Pincers à dissection délicates	II	24
ADSON BIMER	Pincers à dissection délicates	II	24
ADSON BROWN	Pincers à dissection délicates	II	22
ADSON GRAEFE	Pincers à dissection délicates	II	24
Aiguilles à ligatures		VI	28-32
Aiguilles à sutures		VI	27
ALAN PARKS	Écarteurs rectaux	VIII	91
Alésoirs médullaires rigides		XIV	38
ALEXANDER	Ciseaux burins, ostéotomes, gouges	XIII	71
	Rugines et dissecteurs	XIII	29
ALLAINE	Ciseaux à dissection	III	25-26
	Pincers passe-fils, dissecteurs	IV	53
ALLAIRE	Ciseaux délicats	III	15
ALLEN	Pincers clamps intestinales et stomacales	IV	77
ALLIS	Pincers à préhension	IV	94
ALLIS-ADAIR	Pincers à préhension	IV	96
ALLISON	Écarteurs	VII	40
ALM	Écarteurs	VII	111
Amnioscopes		VIII	51
Amplificateur pour greffe de peau		I	10
ANDERSON-ADSON	Écarteurs	VII	119
ANDREW PYNCHON	Canules aspiratrices	XV	26
Anuscopes		VIII	89
ARNOUS	Écarteurs	VII	55
ARRUGA	Microchirurgie pincers fines	X	16
ASCH	O.R.L. pincers et cisaille	XII	34
Attelles malléables		XV	25
AUBERT (FINSTERER)	Canules aspiratrices	XV	26
AUBRY (EN Z)	O.R.L. écarteurs	XII	48
AUFRICHT	O.R.L. écarteurs et crochets	XII	49
	O.R.L. râpes	XII	43
AUSTIN	Pincers à dissection délicates	II	33
AUVARD	Valves vaginales	VIII	49
AUVERT	Écarteurs	VII	86
	Pincers à préhension	IV	92
BABCOCK	Pincers à préhension	IV	100-101
BABCOCK (BABY)	Pincers à préhension	IV	100
BABINSKY	Marteaux à réflexes, Stéthoscope	XV	5
BABY CRILE-WOOD	Porte-aiguilles	VI	15
BABY METZENBAUM	Ciseaux Prestige	III	71
BABY POOLE	Canules aspiratrices	XV	26
BABY SATINSKY	Pincers à préhension	IV	82
BABY-ADSON	Pincers passe-fils, dissecteurs	IV	50
BABY-ALLIS	Pincers à préhension	IV	95
BABY-COLLIN	Écarteurs	VII	81
BABY-CRILE	Pincers hémostatiques	IV	30
BABY-DOYEN	Pincers clamps intestinales et stomacales	IV	70
BABY-HAIGHT	Écarteurs	VII	98
BABY-KOCHER	Pincers clamps intestinales et stomacales	IV	70
BABY-LEXER	Ciseaux à dissection	III	21
BABY-MIXTER	Pincers passe-fils, dissecteurs	IV	58
BABY-OVERHOLT	Pincers passe-fils, dissecteurs	IV	58
BABY-ROUX	Écarteurs	VII	34
BABY-TISCHLER (MINI-TO WNSEND)	Pincers à biopsie	VIII	64
BACKHAUS	Instrumentation de service	XV	20
	Pincers à champs	IV	104-105
BACON	Pincers gouges	XIII	108
BAILEY	Écarteurs	VII	109
BAILEY-BABY	Écarteurs	VII	109
BAINBRIDGE	Pincers clamps vasculaires atrauma	V	14
	Pincers hémostatiques spéciales	IV	44
BAKES	Dilateurs pour voies biliaires	IX	14



		Chapitre	Page
BALFOUR	Écarteurs	VII	89-90
BALFOUR (USA-MODEL)	Écarteurs	VII	91
BALLENGER	O.R.L. couteaux à végétations	XII	24
	O.R.L. gouges	XII	40
BALLENTINE	Pincés utérines	VIII	22
BANE HARTMANN	Pincés gouges	XIII	105
BANKART	Instrumentation pour épaule	XIII	148
BAR	Divers	VIII	60
BARR	Écarteurs rectaux	VIII	90
BARRAQUER	Microchirurgie porte-aiguilles	X	14
BARRAYA	Pincés à dissection délicates	II	14
	Pincés à dissection Prestige	II	50
	Pincés passe-fils, dissecteurs	IV	65
BARRE	Instruments pour voies biliaires	IX	11
BARSKY	Écarteurs, crochets	VII	9
BARTH	Curettes	XIII	54
BECK	Pincés clamps vasculaires atrauma	V	23, 34
BECKMANN	Écarteurs	VII	120-122
	O.R.L. couteaux à végétations	XII	23
BECKMANN (MOORE)	O.R.L. couteaux à végétations	XII	24
BECKMANN CONE	Écarteurs	VII	120
BECKMANN-ADSON	Écarteurs	VII	125
BECKMANN-EATON	Écarteurs	VII	124
BECKMANN-GOITER	Écarteurs	VII	121
BECKMANN-STILLE	Écarteurs	VII	121
BEEBE	Ciseaux pour couper les fils	III	31
BELLUCI	O.R.L. micro instruments	XII	33
BENGOLEA	Pincés hémostatiques longues	IV	39-40
	Pincés hémostatiques Prestige	IV	115
BENNET	Écarteurs	VII	143
BENSAUDE	Anusscopes	VIII	89
BENSON	Pincés à préhension	IV	102
BERGER	Pincés à biopsie	VIII	65
BERGERET TOUPET	Écarteurs	VII	72
BERGMANN	Ciseaux à pansements	III	30
	Écarteurs, crochets	VII	10
	Maillets	XIII	87
BERNHARD	Pincés à champs	IV	105
BESNIER	Curettes	XIII	52
BETHUNE	Costotomes	XIII	122
BEYER	Pincés gouges	XIII	106, 109
BEYER-ZAUFAL	Pincés gouges	XIII	109
BILLEAU	O.R.L. curettes	XII	56
BIRCHER	Instrumentation pour ménisque	XIII	151
BIRCHER-GANSKE	Instrumentation pour ménisque	XIII	154
BIRKETT	Pincés hémostatiques	IV	34
	Bistouris à usage unique stériles	I	7
	Bistouris fixes	I	2
BLAKE	Curettes utérines	VIII	76
	Pincés pour calculs biliaires	IX	7
BLONDIAU	O.R.L. maillets et curettes	XII	54
BLOUNT	Écarteurs	VII	142
	Instrumentation pour ménisque	XIII	152
BLUMENTHAL	Pincés gouges	XIII	102
BOEHLER	Étriers de traction	XIII	161
	Pincés coupantes	XIII	118
	Pincés gouges	XIII	109
BOETTCHER	Ciseaux divers	III	37
BONN	Ciseaux fins	III	39
BONNAIRE	Pincés utérines	VIII	27
BONNEY	Pincés à dissection spéciales	II	12
BONNIOT	Pincés hémostatiques	IV	24
BORDIER-MEUNIER	Trocarts	XV	28
BOSE	O.R.L. speculums	XII	17
BOURGEOIS	O.R.L. pincés à préhension	XII	14
BOWMAN (PALMER)	O.R.L. speculums	XII	17
BOYS-ALLIS	Pincés à préhension	IV	96
BOZEMANN	Pincés à pansements	IV	125
BRAND	Chirurgie des tendons	XIII	11, 14
BRAUN	Divers	VIII	79
	Pincés utérines	VIII	25
BRAUN-STADLER	Ciseaux à épisiotomie	III	81
BREISKY	Pelvimètres	VIII	78
	Valves vaginales	VIII	43
BRIDGE	Pincés hémostatiques longues	IV	37
BRISTOW	Écarteurs	VII	141
BROCK	Curettes	XIII	52
BROPHY	Ciseaux longs et fins	III	49
	Pincés à dissection délicates	II	28
BROWN RESANO	Pincés à dissection spéciales	II	18
BRUENINGS	Abaisse langue	XV	6



		Chapitre	Page
BRUENINGS	O.R.L. Serre-noeuds	XII	20
BRUNETTI	Instruments pour autopsie	XIII	23
BRUNNER	Aiguilles à ligatures	VI	31
	Costotomes	XIII	123
	Écarteurs	VII	45
	Pincés clamps intestinales et stomacales	IV	76
BRUNS	Ciseaux pour plâtres	XV	22
	Curettes	XIII	58, 62
	Instruments pour plâtres	III	85
BRYANT	Pincés à pansements	IV	126
BUCK	O.R.L. curettes	XII	55
	O.R.L. pincés pour oreilles	XII	32
BUCK-GRAMCKO	Écarteurs	VII	132
BUELAU	Trocarts	XV	30
BUNNEL	Chirurgie des tendons	XIII	11-12
	Perforateurs manuels	XIV	9
BUSCH (VEZIEN)	Ciseaux pour le cordon ombilical	III	80
BUSCHE	Curettes	XIII	63
CAIRNS	Pincés hémostatiques	IV	36
CAIRNS (CLOVIS VINCENT)	Rugines et dissecteurs	XIII	37
CANNY-RYALL	Écarteurs	VII	36
	Canules	XV	27
	Canules aspiratrices	XV	26
CAPENER	Ciseaux gouges	XIII	83
CAROLL	Chirurgie des tendons	XIII	13
CARPENTER	Rugines et dissecteurs	XIII	28
CARREL	Clamps bulldog	V	9
	Pincés hémostatiques	IV	16
CASPAR	Crochets	XIII	25
	Curettes	XIII	64
	Écarteurs	VII	46
	Écarteurs	XI	7
	Manches de bistouris, lames U.U.	I	6
	Pincés rongeurs	XI	12-13
	Rugines	XIII	39
CASTANEDA	Pincés clamps nouveau né et pédiatrique	V	39
CASTROVIEJO	Microchirurgie ciseaux	X	5, 8
	Microchirurgie porte-aiguilles	X	12
	O.R.L. crochets	XII	46
CATLIN	Instrument pour amputation	XIII	16
CAUCHOIX	Ciseaux burins, gouges	XIII	77
	Écarteurs	VII	144
CHADWICK	Ciseaux fins	III	39
CHANDLER	Écarteurs	VII	106, 141
CHAPUT	Pincés à préhension	IV	93
CHAPUT-MAYO	Pincés à préhension	IV	93
CHARNLEY	Curettes	XIII	65
	Écarteur, mains de plomb	XIII	143
CHARRIER	Écarteurs	VII	37
CHARRIERE	Instrument pour amputation	XIII	18-19
	Chasse-greffons	XIII	144-145
CHATELIER	O.R.L. pincés à préhension	XII	14
CHEATLE	Matériels divers	XV	32
CHERON	Pincés à pansements	IV	119
CHEVALIER-JACKSON	O.R.L. pincés pour oesophagoscopie	XII	36
CHEVRET	Écarteurs	VII	40
	Chirurgie des tendons	XIII	11-14
CHRISTOPHE	Pincés hémostatiques	IV	33
	Pincés hémostatiques Prestige	IV	117
CHROBACK	Pincés utérines	VIII	24
CINELLI	O.R.L. ostéotomes	XII	39
CIRCERON (MATHIEU)	Divers	VIII	81
	Ciseau à os	XIV	24
	Ciseaux à dissection	III	16-26
	Ciseaux à épisiotomie	III	81-82
	Ciseaux à incision	III	28
	Ciseaux à ongles	III	88
	Ciseaux à pansements	III	29-30
	Ciseaux burins, gouges	XIII	68-70, 76-82
	Ciseaux burins, ostéotomes, gouges	XIII	69-75
	Ciseaux chirurgicaux	III	9-11
	Ciseaux coupe ligatures	III	41-42
	Ciseaux délicats	III	12-15
	Ciseaux en tungstène	III	57-69
	Ciseaux fins	III	14, 38-44
	Ciseaux gouges	XIII	78-80
	Ciseaux longs et fins	III	46-48
	Ciseaux ORL	III	83-84
	Ciseaux ostéotomes	XIII	66-67
	Ciseaux ostéotomes, gouges	XIII	81
	Ciseaux pour chirurgie osseuse	III	86



		Chapitre	Page
Ciseaux pour chirurgie vasculaire		III	32-36
Ciseaux pour couper les fils		III	31
Ciseaux pour intervention en profondeur		III	51-52
Ciseaux pour le cordon ombilical		III	80
Ciseaux pour plâtres		XV	22
Ciseaux Prestige		III	70-79
CITELLI	O.R.L. emporte pièces	XII	27
Clamps bulldog		V	9-11
CLAQUE	O.R.L. écarteurs	XII	48
CLEVELAND	Pincés coupantes	XIII	117
	Pincés gouges	XIII	103
CLOVIS VINCENT	O.R.L. curettes	XII	56
	Perforateur	XI	9
	Pincés à dissection très fines	II	11
	Rugines	XIII	48
	Spatules	XI	3
CLOWARD	Crochets	XIII	24
	Curettes	XIII	59
COAKLEY	O.R.L. curettes	XII	55
COBB	Rugines	XIII	51
COLLER-CRILE	Pincés hémostatiques	IV	30
COLLIN	Costotomes	XIII	121
	Écarteurs	VII	34, 79-80
	Pince hystérolable	VIII	52
	Pincés à préhension	IV	87, 90
	Spéculums vaginaux	VIII	31
COLLIN POZZI	Pincés utérines	VIII	13
COLVER	O.R.L. pincés à préhension	XII	13
CONVERSE	O.R.L. crochets	XII	47
	Porte-aiguilles	VI	14
COOLEY	Dilatateurs vasculaires	V	40
	Écarteurs	VII	102
	Pincés à dissection vasculaires	II	42
	Pincés clamps nouveau né et pédiatrique	V	37-38
	Pincés clamps vasculaires atrauma	V	33-37
	Pincés clamps vasculaires atrauma	V	34
COOLEY-DERRA	Écarteurs	VII	53
CORYLLOS	Écarteurs	VII	53
Costotomes		XIII	121-125
COTT	Écarteurs	VII	77
COTT (À LAMBEAUX)	Pincés utérines	VIII	24
COTTLE	Ciseaux ORL	III	84
	Ciseaux Prestige	III	79
	Écarteurs, crochets	VII	10
	Maillets	XIII	89
	O.R.L. burins et gouges	XII	37
	O.R.L. crochets	XII	47
	O.R.L. râpes	XII	43
	Rugines	XIII	43
	Rugines et dissecteurs	XIII	31
COTTLE (KILLIAN)	O.R.L. speculums	XII	18
COTTLE NEIVERT	O.R.L. crochets	XII	47
COURTY	Écarteurs	VII	131
CRAFOORD	Ciseaux pour intervention en profondeur	III	51
	Pincés hémostatiques longues	IV	43
CRAFOORD (SELLORS)	Pincés hémostatiques spéciales	IV	45
CRAIG-DOMNICK	O.R.L. pincés à préhension	XII	15
CRAWFORD	Écarteurs	VII	36
CREED	Rugines et dissecteurs	XIII	28
CRILE	Crochets	XIII	25
	Écarteurs	VII	33
	Pincés hémostatiques	IV	28-29
	Pincés hémostatiques Prestige	IV	117
CRILE MURAY	Porte-aiguilles	VI	11
CRILE-WOOD	Instrumentation de service	XV	18
	Porte-aiguilles	VI	11, 15
Crochets		XIII	24-25, 95
Curettes		XIII	52-65
Curettes pour voies biliaires		IX	12-13
Curettes utérines		VIII	68-77
CUSCHING-KOCHER	Écarteurs	VII	17
CUSCO	Spéculums vaginaux	VIII	33-34
CUSHING	Crochets	XIII	25
	Écarteurs	VII	13, 62
	Microchirurgie crochets	X	20
	Perforateur	XI	10
	Pincés à dissection délicates	II	25
	Pincés à dissection mors tungstène	II	46
	Rugines	XIII	41-42
CUZZI	Curettes utérines	VIII	75
CZERNY	Pincés pour calculs biliaires	IX	7
	Pincés utérines	VIII	25



		Chapitre	Page
CZERNY	Spéculums rectaux	VIII	88
DALE	Pincers clamps vasculaires atrauma	V	30
DANDY	Microchirurgie crochets	X	20
	Pincers hémostatiques	IV	26
DANIS	Instrumentation pour épaule	XIII	149
	Instrumentation pour ligatures	XIII	150
	Pincers à fils métalliques	XIV	29
DARGENT	Pincers utérines	VIII	16
	Valves vaginales	VIII	42
DARTIGUES	Pince hystérolable	VIII	52
DARTIGUES (LAPAROSTAT)	Écarteurs	VII	94
DAUBENSPECK	Curettes	XIII	60
DAUPHIN	Ciseaux chirurgicaux	III	11
	Ciseaux délicats	III	12
DAUTREY	O.R.L. écarteurs	XII	48
DAVID	Pincers gouges	XIII	114
Daviers		XIII	126-142
DAVIS	Rugines et dissecteurs	XIII	27
DAVIS-BOYLE	O.R.L. ouvre-bouche	XII	10
DE MARTEL	Ciseaux pour chirurgie vasculaire	III	35
	Instrument pour amputation	XIII	20
	Rugines et dissecteurs	XIII	37
DE MARTEL - WOLFSON	Pincers clamps intestinales et stomacales	IV	80
DE MARTEL (PITANGUY)	Pincers à préhension	IV	84
DEAN	Ciseaux divers	III	45
DEAVER	Ciseaux fins	III	14
	Écarteurs	VII	59-60
DEBAKEY	Ciseaux en tungstène	III	69
	Ciseaux pour chirurgie vasculaire	III	33, 36
	Clamps bulldog	V	10
	Dilatateurs vasculaires	V	40
	Écarteurs	VII	103, 130
	Pincers à dissection mors tungstène	II	44
	Pincers à dissection vasculaires	II	41-43
	Pincers clamps vasculaires atrauma	V	13-32
	Porte-aiguilles vasculaires	VI	20
DEBAKEY (LELAND JONES)	Pincers clamps vasculaires atrauma	V	14
DEBAKEY BAHNSON	Pincers clamps vasculaires atrauma	V	25
DEBAKEY CAROTID	Clamps bulldog	V	11
DEBAKEY DIETHRICH	Pincers à dissection vasculaires	II	43
DEBAKEY GERALD	Pincers à dissection vasculaires	II	43
DEBAKEY GLOVER	Clamps bulldog	V	11
DEBAKEY MOSQUITO	Pincers clamps vasculaires atrauma	V	27
DEBAKEY PEAN	Pincers clamps vasculaires atrauma	V	26
DEBAKEY POTTS	Pincers clamps vasculaires atrauma	V	12
DEBAKEY RANKIN	Pincers clamps vasculaires atrauma	V	27
DEBAKEY SATINSKY	Clamps bulldog	V	11
DEBAKEY-BECK	Pincers clamps vasculaires atrauma	V	16
DECOULX	Écarteurs	VII	123
DELABARRE	O.R.L. ouvre-bouche	XII	7
DELESTRE	Ciseaux à épisiotomie	III	81
DEMEL	Pincers à fils métalliques	XIV	29
DEMELIN-SUZOR	Forceps spatules	VIII	54
DEMOISELLE	Chasse-greffons	XIII	144
DENHART	O.R.L. ouvre-bouche	XII	7
DENIS BROWN	Écarteurs	VII	84
DERF	Porte-aiguilles	VI	8, 14
Dermatome à main		I	8-9
DERRA	Pincers clamps vasculaires atrauma	V	29
DESCHAMPS	Aiguilles à ligatures	VI	32
DESCHAMPS SCHAUTA	Aiguilles à ligatures	VI	31
DESGOUTTES	Pincers à dissection spéciales	II	18
DESJARDINS	Curettes pour voies biliaires	IX	12
	Instruments pour voies biliaires	IX	11
	Pincers pour calculs biliaires	IX	6
DESMARET	Écarteurs	VII	70
DESMARRES	Écarteurs	VII	11
DIETRICH	Pincers clamps vasculaires atrauma	V	18
Dilatateurs pour voies biliaires		IX	14
Dilatateurs utérins		VIII	82-84
Dilatateurs vasculaires		V	40
DINGMAN	Écarteurs	VII	66
DINGMANN	Daviers	XIII	127
	O.R.L. ouvre-bouche	XII	11
DIXON-LOVELACE	Pincers hémostatiques	IV	27
DOCKHORN	Écarteurs	VII	64
DOUAY	Pincers à biopsie	VIII	65
DOUGLAS	Valves vaginales	VIII	41
DOYEN	Aiguilles à ligatures	VI	28
	Ciseaux divers	III	27
	Costotomes	XIII	125



		Chapitre	Page	
DOYEN	Divers	VIII	81	
	Écarteurs	VII	61	
	O.R.L. ouvre-bouche	XII	8	
	Perforateur	XI	9	
	Pincés à champs	IV	103	
	Pincés clamps intestinales et stomacales	IV	69, 72	
	Pincés utérines	VIII	27	
	Porte-aiguilles	VI	9	
	Rugines et dissecteurs	XIII	45	
	Valves vaginales	VIII	37, 46	
	Perforateur	XI	9	
DOYEN (COURONNE DETREPAN)	Écarteurs	VII	69	
DRYSSEN	Écarteurs	VII	107	
DUBOIS	Ciseaux pour intervention en profondeur	III	51	
DUBOST	Ciseaux à dissection	III	20	
	Ciseaux en tungstène	III	67	
	Écarteurs	VII	99	
DUBOST NOGENT	Écarteurs	VII	100	
DUFOURMENTEL	O.R.L. râpes	XII	42	
	Pincés à dissection délicates	II	32	
DUMONT	Pincés à dissection spéciales	II	35	
DUNHILL	Pincés hémostatiques	IV	17	
DUPLAY	O.R.L. speculum	XII	16	
	Pincés utérines	VIII	13	
DUPONT	Ciseaux ostéotomes	XIII	67	
DURAND	Pincés à dissection Prestige	II	50	
	Pincés à dissection spéciales	II	17	
DUVAL	Pincés à dissection spéciales	II	21	
	Pincés à préhension	IV	89-91	
Écarteur, mains de plomb		XIII	143	
Écarteurs		VII	11-145	
		XI	6-8	
Écarteurs rectaux		VIII	90-91	
Écarteurs valves malléables		VII	41	
Écarteurs VK		VII	71	
Écarteurs, crochets		VII	9-10	
ECHLIN	Pincés gouges	XIII	113	
EISELSBERG	Ciseaux pour couper les fils	III	31	
EMMET	Aiguilles à ligatures	VI	29	
	Pincés à pansements	IV	126	
Endospéculum		VIII	36	
ENGEL	Instrument pour amputation	XIII	21	
ENGLISH MODEL	Pincés à dissection spéciales	II	12	
EPPENDORF	Pincés à biopsie	VIII	66	
ERRICO	Perforateur	XI	10	
ESMARCH	Ciseaux à pansements	III	30	
	Matériels divers	XV	31	
Étriers de traction		XIII	158-161	
EUFRATE	Porte-aiguilles vasculaires	VI	22	
EVANS	Pincés à dissection mors tungstène	II	45	
EVES	O.R.L. Serre-noeuds	XII	20	
FARABEUF	Bistouris fixes	I	2	
	Ciseaux burins, gouges	XIII	76	
	Daviers	XIII	133	
	Écarteurs	VII	31, 42	
	Instrument pour amputation	XIII	19	
	Rugines et dissecteurs	XIII	44	
	Écarteurs	VII	33	
	FARABEUF-CORTI	Écarteurs	VII	33
	FARKAS	Pincés à dissection spéciales	II	20
	FAVALORO	Ciseaux pour chirurgie vasculaire	III	36
FEILCHENFELD	Pincés à échardes	II	51	
FERGUSSON	Ciseaux à incision	III	28	
	Daviers	XIII	139	
	O.R.L. canules aspiratrices	XII	58	
FERRIS SMITH KERRISSON	Pincés emporte pièces	XI	16-23	
FERRIS-SMITH-CUSHING	Pincés rongeurs	XI	14	
FICAT	Poinçons et trépan	XIII	94	
FINOCHIETTO	Écarteurs	VII	95-98	
	Pincés passe-fils, dissecteurs	IV	66	
	Porte-aiguilles	VI	10, 18	
FINOCHIETTO-BURFORD	Écarteurs	VII	107	
FINSEN	Écarteurs	VII	111	
FISH	Crochets	XIII	24	
	O.R.L. crochets	XII	45	
	Stylets	XV	12	
FOERSTER	Pincés à pansements	IV	124	
FOMON	Ciseaux ORL	III	83-84	
	Ciseaux Prestige	III	78	
	O.R.L. crochets	XII	46	
	O.R.L. râpes	XII	44	
Forceps spatules		VIII	53-59	



	Chapitre	Page
Forets	XIV	5
Fraises et jauges	XIV	10
FRAZIER	X	19
	O.R.L. canules aspiratrices	XII
	Rugines et dissecteurs	XIII
FREER	XII	37
	O.R.L. crochets	XII
	O.R.L. éleveurs	XII
	O.R.L. gouges	XII
	Rugines et dissecteurs	XIII
	Rugines et dissecteurs	XIII
FREER-YASARGIL	XII	59
FRENCH	XIII	101
FRIEDMANN DELIKAT	VII	61
FRITSCH	XIII	113
FRYKHOLM	IV	34
FUCHSIG	VII	142
FUKUDA	XII	42
GALLAHER	VII	130
GELPI	IV	57
GEMINI	II	30
GERALD	XIII	123
GIERTZ-STILLE	XIII	20
GIGLI	VII	9
GILLIES	II	31
	Pincés à dissection délicates	II
	Porte-aiguilles	VI
GILLIES-BABY	VI	24
GIL-VERNET	VII	12
GIL-VERNET (PAPIN)	VII	12
GINESTET	XII	49
GLOVER	V	28-29
GLUCK	XIII	123
GOELET	VII	34
GOLDMANN-FOX	III	66
	Ciseaux fins	III
GOOD	III	37
GORNEY	III	77
GOSSET	VII	87-88
GOUILLOUD	IV	47
GOURDET	VIII	68
GRAEFE	III	39
	Ciseaux fins	III
	Microchirurgie crochets	X
GRAHAM	X	20
GRAVE	VIII	34
GRAY	IX	10
GRAZIL	III	13
GREEN	VII	62
GREEN-ARMYTAGE	VIII	30
GREGOIRE	II	19
	Pincés à dissection spéciales	II
	Pincés à préhension	IV
GREGORY	V	31
GREGORY SOFT	V	10
GROSS MAYER	IV	120
GRUENWALD	XII	28
	O.R.L. emporte pièces	XII
	Pincés à dissection mors tungstène	II
GUERRIER	XII	49
	O.R.L. écarteurs et crochets	XII
Guide mèches	XIV	14-16
Guide pour alésoirs et clous IM	XIV	39
GUILLAUME	XIII	78
GUNNAR-HEY	IV	108
GUTHRIE	X	19
GUYON	IX	8
	Instruments pour urologie	VIII
GUYON-FREUDENBERG	XV	32
HABERER	VII	38
HAIGHT	VII	102
HAJEK	XIII	87
	O.R.L. emporte pièces	XII
HAKANSSON	XIII	103
HALLE	III	83
	Curettes	XIII
	Écarteurs rectaux	VIII
	Rugines et dissecteurs	XIII
HALSEY	VI	8
HALSEY (WEBSTER)	VI	13
HALSTEAD	XV	19
	Pincés hémostatiques	IV
	Pincés hémostatiques Prestige	IV
HALSTEAD-MOSQUITO	IV	23
HANK	VIII	84
HARKEN	IV	83



		Chapitre	Page
HARKEN	Pincès clamps vasculaires atrauma	V	18
HARRINGTON	Écarteurs	VII	58
	Pincès passe-fils, dissecteurs	IV	67
HARRINGTON BABY	Écarteurs	VII	58
HARRINGTON-PEMBERTON	Écarteurs	VII	58
HARRIS	Pincès à fils métalliques	XIV	29
HARTMANN	Écarteurs	VII	36
	O.R.L. diapasos	XII	59-60
	O.R.L. emporte pièces	XII	28
	O.R.L. pincès à polypes	XII	30
	O.R.L. pincès pour oreilles	XII	31-32
	O.R.L. speculums	XII	16
	Pincès clamps intestinales et stomacales	IV	68
HARTMANN CITELLI	O.R.L. pincès à polypes	XII	30
HARTMANN HALLE	O.R.L. speculums	XII	18
HARTMANN WEINGARTNER	O.R.L. pincès pour oreilles	XII	31
HARVEY	Ciseaux pour couper les fils	III	31
HARVEY JACKSON	Écarteurs	VII	124
HAUTEFEUILLE	Écarteurs	VII	72
HEANEY	Curettes utérines	VIII	75
	Écarteurs	VII	37
	Pincès utérines	VIII	19
	Porte-aiguilles	VI	10
HEANEY-BALLENTINE	Pincès utérines	VIII	22
HEATH	Instruments à sutures	VI	7
HEGAR	Dilatateurs utérins	VIII	82-84
HEGAR BAUMGARTNER	Porte-aiguilles	VI	11
HEGAR VASCULAR	Porte-aiguilles vasculaires	VI	22
HEGAR-OLSEN	Porte-aiguilles	VI	23
HEGAR-OLSEN-BABY	Porte-aiguilles	VI	23
HEGEMANN	Ciseaux pour chirurgie vasculaire	III	34
HEGENBARTH	Instruments à sutures	VI	5
HEIFETZ	Spatules	XI	5
HEISS	Pincès hémostatiques longues	IV	38
HEISS (HOLZEIMER)	Écarteurs	VII	111
HEISTER	O.R.L. ouvre-bouche	XII	8
HELFRICH-BIER	Instrument pour amputation	XIII	19
HENKE	O.R.L. élévateurs	XII	51
HENLEY	Écarteurs	VII	116
HENNING	Pince pour plâtres	XV	24
HERCULES	Pincès à couper les fils	XIV	33-35
	Pincès à fils métalliques	XIV	28
HERRICK	Instruments pour voies biliaires	IX	9
HERTZLER	Écarteurs	VII	108
HESS	Écarteurs	XI	8
HEY GROVES	Daviers	XIII	137
HEYMANN	Ciseaux ORL	III	84
	Ciseaux Prestige	III	79
HEYWOOD-SMITH	Pincès hémorroïdales	VIII	94
	Pincès utérines	VIII	28
HIBBS	Ciseaux burins, ostéotomes, gouges	XIII	74
	Écarteurs	VII	37
HI-LEVEL KNOWLES	Ciseaux à incision	III	28
HOEN	Rugines et dissecteurs	XIII	34
HOFFMAN	Pincès diverses	IV	110
HOHMANN ALDINGER	Écarteurs	VII	137
HOLSHER	Écarteurs	XI	8
HOLZBACH	Pincès utérines	VIII	21
HONTON	Ciseaux gouges	XIII	79
HORSLEY	Rugines et dissecteurs	XIII	36
HÖSEL	Écarteurs	VII	46
HOWARTH	Rugines et dissecteurs	XIII	27
HRYNTSCHAK	Écarteurs	VII	92
HUDSON	Perforateur	XI	10
HUMBY	Écarteurs, crochets	VII	9
HUNTER	Pincès à échardes	II	51
HURD	O.R.L. élévateurs	XII	51
	Hysteromètres	VIII	85
IMA	Microchirurgie pincès fines	X	17
	Instrument pour amputation	XIII	15-21
	Instrumentation de cambrage	XIV	20-22
	Instrumentation de service	XV	9-10, 15-20
	Instrumentation pour agrafes	XIV	50-51
	Instrumentation pour cerclage	XIV	52
	Instrumentation pour clou RUSH	XIV	42
	Instrumentation pour clous élastiques	XIV	43-46
	Instrumentation pour enclouage IM	XIV	40-41
	Instrumentation pour épaule	XIII	146-149
	Instrumentation pour genou	XIII	156-157
	Instrumentation pour ligatures	XIII	150
	Instrumentation pour ménisque	XIII	151-154



		Chapitre	Page
Instrumentation pour plaques		XIV	17-19
Instrumentation pour vis perforées		XIV	47-49
Instruments à ligatures		VI	33-34
Instruments à sutures		VI	5-7
Instruments pour autopsie		XIII	22-23
Instruments pour pédicules rénaux		IX	8
Instruments pour plâtres		III	85
Instruments pour prostate		VIII	95-96
Instruments pour urologie		VIII	86
Instruments pour voies biliaires		IX	9-11
IOWA	Pincés utérines	VIII	10
ISRAEL	Écarteurs	VII	29
ISSELIN	Poinçons	XIII	91
IVG	Divers	VIII	81
J.L. FAURE	Pincés à biopsie	VIII	62
	Pincés à dissection spéciales	II	19
JACKSON	Écarteurs	VII	15
	Valves vaginales	VIII	44
JACOBS	Pincés utérines	VIII	10
JACOBSON	Curettes	XIII	53
	Microchirurgie porte-aiguilles	X	13
JACOBSON ADSON	Pincés à dissection délicates	II	23
JACOBSON HALSTEAD	Pincés hémostatiques	IV	22
JACOBSON-ADSON	Pincés passe-fils, dissecteurs	IV	56
JAMESON	Ciseaux longs et fins	III	46
	Ciseaux Prestige	III	73
	Porte-aiguilles	VI	12
JANSEN	Curettes	XIII	54
	Écarteurs	VII	112
	Pincés à dissection O.R.L.	II	40
	Pincés gouges	XIII	105, 108
	Rugines	XIII	41
JANSEN (MIDDLETON)	O.R.L. emporte pièces	XII	29
JANSEN-DEEP	Écarteurs	VII	112
JAVID	Pincés clamps vasculaires atrauma	V	33
JAYLE	Spéculum vaginal	VIII	32
	Valves vaginales	VIII	48
JENNINGS	O.R.L. ouvre-bouche	XII	9
JESCO	Ciseaux divers	III	56
JL FAURE	Pincés utérines	VIII	15, 17
JOHNS HOPKINS	Clamps bulldog	V	9
JOLL	Écarteurs	VII	131
JONES	Pincés à champs	IV	103
JOSEPH	Ciseaux ORL	III	83
	Ciseaux Prestige	III	76
	O.R.L. Instruments de Joseph	XII	52-53
JOST	Rugines et dissecteurs	XIII	29
JUDD-ALLIS	Pincés à préhension	IV	95
JUDD-MASSON	Écarteurs	VII	93
JUDET	Ciseaux burins, ostéotomes, gouges	XIII	75
	Écarteurs	VII	140
	Maillets	XIII	90
KADER	Écarteurs	VII	55
KANTROWITZ	Pincés passe-fils, dissecteurs	IV	61
KATZIN	Microchirurgie ciseaux	X	7
KATZIN-BARRAQUER	Microchirurgie ciseaux	X	7
KAYE	Ciseaux Prestige	III	77
KAZANJIAN	Pincés coupantes	XIII	117
KELLY	Anusscopes	VIII	89
	Ciseaux en tungstène	III	57
	Ciseaux longs et fins	III	48
	Écarteurs	VII	50, 55
	Pincés hémostatiques	IV	31
	Pincés hémostatiques Prestige	IV	116
	Pincés utérines	VIII	28
KELLY-RANKIN	Pincés hémostatiques	IV	32
KERN	Daviers	XIII	135
KERRISSON	O.R.L. emporte pièces	XII	27
KEVORKIAN	Curettes utérines	VIII	77
	Pincés à biopsie	VIII	66-67
KEY	Rugines	XIII	41
KIELAND	Forceps spatules	VIII	55
KIENNY	Écarteurs	VII	19
KILLIAN	O.R.L. élévateurs	XII	50
	O.R.L. gouges	XII	40
KILNER	Ciseaux délicats	III	15
	Écarteurs, crochets	VII	10
	O.R.L. crochets	XII	47
	Porte-aiguilles	VI	13
KILNER (RAGNELL)	Ciseaux en tungstène	III	57
KILNER-DOUGHTY	O.R.L. ouvre-bouche	XII	11



		Chapitre	Page
KIRSCH	Écarteurs	VII	64
KIRSCHNER	Écarteurs	VII	83
	Étriers de traction	XIII	158-159
	Instruments à ligatures	VI	34
KIRSCHNER (AMERICAN)	Étriers de traction	XIII	160
KLAPP	Écarteurs	VII	20
KLEINERT-KUTZ	Chirurgie des tendons	XIII	13
	Écarteurs, crochets	VII	9
KLEINSCHMIDT	Pincés clamps intestinales et stomacales	IV	77
KLINKENBERG	Ciseaux divers	III	50
	Ciseaux en tungstène	III	67
KNAPP	Ciseaux fins	III	38
	O.R.L. crochets	XII	46
KNOWLES	Ciseaux à incision	III	28
KOCHER	Écarteurs	VII	26-27, 43, 47, 49
	Instrumentation de service	XV	18
	O.R.L. couteaux spatules	XII	25
	Pincés clamps intestinales et stomacales	IV	73-74
	Pincés hémostatiques	IV	9-11
	Pincés hémostatiques Prestige	IV	116
KOCHER-LANGENBECK	Écarteurs	VII	42
KOCHER-WAGNER	Écarteurs	VII	46
KOENING	Crochets	XIII	95
KOGAN	Endospéculum	VIII	36
KÖLBEL	Instrumentation pour épaule	XIII	146
KÖNIG	Écarteurs	VII	13
	Instruments à ligatures	VI	33
	Rugines et dissecteurs	XIII	35
KÖRTE	Écarteurs	VII	28-29, 48
KÖRTE-WAGNER	Écarteurs	VII	28
KRAEMER	Rugines	XIII	43
KRAMER	Rugines	XIII	41
KRAUSE	O.R.L. Serre-noeuds	XII	21
	Trocarts	XV	30
KRAUSE-VOSS	O.R.L. Serre-noeuds	XII	21
KRISTELLER	Valves vaginales	VIII	44
KRÖNLEIN	Pincés hémostatiques	IV	17
KÜMMEL	Écarteurs	VII	48
LA GRANGE	Ciseaux fins	III	38
LA HEY (SWEET)	Pincés passe-fils, dissecteurs	IV	60
LABORDE	O.R.L. dilateurs	XII	12
LAGROT	Dermatome à main	I	9
LAHEY	Écarteurs	VII	27
	O.R.L. pincés à préhension	XII	14
LAMBERT KAY	Pincés clamps vasculaires atrauma	V	22
LAMBOTTE	Ciseaux ostéotomes	XIII	67
	Crochets	XIII	95
	Daviers	XIII	134
	Écarteurs	VII	145
	Pincés spécifiques	XIV	25
	Rugines	XIII	49
LAMBOTTE (PAUWELLS)	Ciseaux ostéotomes	XIII	66
LANDANGER	Daviers	XIII	128
	Instrumentation pour ménisque	XIII	153
	Pincés à biopsie	VIII	64
	Pincés à pansements	IV	122
LANDAU	Trocarts	XV	30
	Valves vaginales	VIII	43
LANDOLT	Ciseaux divers	III	45
	Manches de bistouris, lames U.U.	I	6
LANE	Écarteurs	VII	141
	Pincés à dissection spéciales	II	13
	Pincés clamps intestinales et stomacales	IV	79
LANE (KERN)	Daviers	XIII	135
LANE (PAUCHET)	Pincés diverses	IV	109
LANE TRETOWAN	Écarteurs	VII	141
LANGE	Instruments pour plâtres	III	85
LANGE-HOHMANN	Écarteurs	VII	133-137
LANGENBECK	Daviers	XIII	139
	Écarteurs	VII	44
	Instrument pour amputation	XIII	16-17
	Porte-aiguilles	VI	26
	Rugines	XIII	42, 47
	Rugines et dissecteurs	XIII	33
LANGENBECK (LARREY)	Instrument pour amputation	XIII	18
LANGENBECK-GREEN	Écarteurs	VII	17, 20
LARDENOIS	Écarteurs	VII	38-39
LAWRENCE	Pincés passe-fils, dissecteurs	IV	60
LAZAR	Microchirurgie pincés fines	X	16
LE MEE	Abaisse langue	XV	7
	O.R.L. speculum	XII	16



		Chapitre	Page
LEBEAU	O.R.L. gouges	XII	40
	Rugines et dissecteurs	XIII	34
LEBSCHÉ	Costotomes	XIII	125
LECOUTEUR	Abaisse langue	XV	7
LEES	Pincés clamps vasculaires atrauma	V	19
LEGUEU	Écarteurs	VII	60, 93
	Pincés clamps	IV	46
LEKSELL- STILLE	Pincés gouges	XIII	112
LELIEVRE	O.R.L. burins et gouges	XII	38
	Rugines	XIII	48
LEMAIRE	Instrumentation pour genou	XIII	156
LEMPERT	Curettes	XIII	61
	O.R.L. élévateurs	XII	51
	Pincés gouges	XIII	106
LEPAGE	Pincés utérines	VIII	26
LERAT	Daviers	XIII	142
LERICHE	Écarteurs, crochets	VII	10
	Instrumentation de service	XV	19
	Pincés hémostatiques	IV	25
	Pincés hémostatiques Prestige	IV	114
	Rugines et dissecteurs	XIII	33
	Valves	VII	57
LERICHE-BUGATTI	Valves	VII	57
LERMOYER	O.R.L. couteaux à végétations	XII	23
LETOURNEL	Curettes	XIII	65
LEVRET	Forceps spatules	VIII	58
LEWIN	Daviers	XIII	142
LEWIS	O.R.L. râpes	XII	43
LEXER	Ciseaux à dissection	III	21
	Ciseaux burins, gouges	XIII	82
	Ciseaux ostéotomes, gouges	XIII	81
	Ciseaux à dissection	III	21
LEXER-FINO	Ciseaux en tungstène	III	60-61
LICHTENBERG	Porte-aiguilles	VI	26
LICHTWITZ	Trocarts	XV	30
LIEGE	Pincés à préhension	IV	99
LIMA	O.R.L. maillets et curettes	XII	54
LISTER	Ciseaux à pansements	III	29
	Ciseaux en tungstène	III	66
	Instrumentation de service	XV	15
	Pincés à pansements	IV	126
LISTER-EXCENTRIC	Ciseaux à pansements	III	30
LISTON	Costotomes	XIII	121
	Instrument pour amputation	XIII	15
	Pincés coupantes	XIII	116, 119
LITTON-KEY (HORSLEY)	Pincés coupantes	XIII	120
LITTAUER	Ciseaux coupe ligatures	III	42
LITTAUER-LISTON	Pincés coupantes	XIII	117
LITTLER	Ciseaux coupe ligatures	III	42
LITTLEWOOD	Pincés à préhension	IV	99
LOCHARD	Pincés diverses	IV	110
LOCKHART MUMMARY	Sondes cannelées	XV	13
LOCKLIN	Ciseaux fins	III	44
LOCKWOOD	Pincés à préhension	IV	90
LOCKWOOD-ALLIS	Pincés à préhension	IV	97
LOMBARD	Maillets	XIII	89
	Pincés gouges	XIII	98
LORENZ	Ciseaux à pansements	III	29
LORNA	Pincés à champs	IV	106
LORTAT-JACOB	Matériels divers	XV	32
LOUTE	Pincés à fils métalliques	XIV	29
LOVE	Écarteurs	XI	6-7
LOVE (MORSE)	Écarteurs	VII	13
LOVE-ADSON	Rugines	XIII	38
LOVELACE	Pincés à préhension	IV	92
LOWE	Écarteurs	VII	14
LOWER	Pincés passe-fils, dissecteurs	IV	59
LOWMAN	Daviers	XIII	141
LOWMAN-HOGLUND	Daviers	XIII	141
LUBET BARBON	O.R.L. pincés à préhension	XII	13
LUC	O.R.L. pincés à préhension	XII	15
LUCAE	Maillets	XIII	87
	O.R.L. crochets	XII	45
	O.R.L. diapasons	XII	60
	Pincés à dissection O.R.L.	II	40
LUCAE HARTMANN	O.R.L. diapasons	XII	59
LUCAS	Ciseaux burins, gouges	XIII	68
	Ciseaux burins, ostéotomes, gouges	XIII	74
LUCAS-CHAMPIONNIERE	Tréphines et perforateurs	XIV	37
LUER	Écarteurs	VII	33
	Pincés gouges	XIII	103-104



		Chapitre	Page
LUER KOERTE	Curettes pour voies biliaires	IX	13
LUER LOCK	Canules	XV	27
LUER-FRIEDMANN	Pincés gouges	XIII	101
LUKENS	Écarteurs	VII	15
MAC EVEN	Ciseaux burins, ostéotomes, gouges	XIII	75
	Maillets	XIII	86
MAC INDOE	Pincés coupantes	XIII	118
MAC KEE	Écarteurs	VII	117
MAGILL	Instrumentation de service	XV	9
	Maillets	XIII	85-90
MAINGOT	Pincés utérines	VIII	21
MALTZ	O.R.L. râpes	XII	42
	Manches de bistouris, lames U.U.	I	3-6
	Mandrins	XIV	7
	Mandrins universels	XIV	8
MANGIAGALLI	Valves vaginales	VIII	41
MARKHAM-MEYERDING	Écarteurs	VII	128
MARQUARDT	Pincés gouges	XIII	110
	Marteaux à réflexes, Stéthoscope	XV	5
MARTIN	Écarteurs	VII	51
	Pelvimètres	VIII	78
MARTIN (SIMPSON)	Hysteromètres	VIII	85
MARTIN-CARTILAGE	Ciseaux divers	III	37
MARTINI	Curettes	XIII	53
MASING	O.R.L. élévateurs	XII	50
MASING (NEIVERT)	Porte-aiguilles	VI	13
MASING (SILVER)	O.R.L. ostéotomes	XII	39
MASSON	Porte-aiguilles	VI	12
MASSON	Porte-aiguilles	VI	17
	Matériels divers	XV	31-33
MATHEY	Écarteurs	VII	110
MATHIEU	Écarteurs	VII	35
	Pincés utérines à polypes	VIII	11
	Porte-aiguilles	VI	12, 25
	Spéculums rectaux	VIII	87
	Valves vaginales	VIII	46
MAURER	Costotomes	XIII	122
	Écarteurs	VII	110, 146
	Rugines	XIII	50
MAYFIELD	Pincés gouges	XIII	110
MAYO	Abaisse langue	XV	6
	Ciseaux à dissection	III	16
	Ciseaux en tungstène	III	59
	Ciseaux Prestige	III	70
	Instrumentation de service	XV	16
	Matériels divers	XV	32
	Pincés à dissection spéciales	II	17
	Pincés pour calculs biliaires	IX	7
MAYO BLAKE			
MAYO ROBSON	Pincés clamps intestinales et stomacales	IV	71
MAYO-ADAMS	Écarteurs	VII	81
MAYO-ALSACE	Ciseaux à dissection	III	18
MAYO-HARRINGTON	Ciseaux à dissection	III	19
MAYO-HEGAR	Instrumentation de service	XV	18
	Porte-aiguilles	VI	11, 16-18
MAYO-LEGER	Ciseaux à dissection	III	18
MAYO-LEXER	Ciseaux en tungstène	III	60-61
	Ciseaux Prestige	III	70
MAYO-LYON	Ciseaux à dissection	III	18
MAYO-NOBLE	Ciseaux à dissection	III	19
MAYO-SANTY	Ciseaux à dissection	III	19
MAYO-STILLE	Ciseaux à dissection	III	17
	Ciseaux en tungstène	III	60-61
	Ciseaux Prestige	III	70
MC DONALD	Rugines et dissecteurs	XIII	31
MC GIVNEY	Pincés hémorroïdales	VIII	94
MC INDOE	Pincés à dissection délicates	II	31
	Pincés à dissection mors tungstène	II	47
MC KENTY	O.R.L. élévateurs	XII	50
	Rugines	XIII	39
MC LEAN	Forceps spatules	VIII	55
MC-INDOE	Ciseaux divers	III	37
McKENZIE	Perforateur	XI	10
MEAD	Maillets	XIII	88
	Pincés gouges	XIII	102
MEEKER	Pincés passe-fils, dissecteurs	IV	63
MERCEDES	Écarteurs	VII	105
MERIAM	Pincés à dissection délicates	II	29
MERLE D'AUBIGNÉ	Écarteurs	VII	139-140
	Instrumentation pour épaule	XIII	148
	Poinçons	XIII	92
	Rugines	XIII	49



		Chapitre	Page
MERLE D'AUBIGNÉ (BANKART)	Instrumentation pour épaule	XIII	147
MERVEILLEUX	Ciseaux Prestige	III	75
Mesureurs		XIII	96
METZENBAUM	Ciseaux à dissection	III	22-23
	Ciseaux en tungstène	III	62
	Ciseaux Prestige	III	71
	Instrumentation de service	XV	17
	Instruments pour prostate	VIII	95
METZENBAUM-FINO	Ciseaux à dissection	III	24
	Ciseaux en tungstène	III	63-65
	Ciseaux Prestige	III	71
MEYERDING	Écarteurs	VII	18,49
MICHEL	Instruments à sutures	VI	5-7
MICHELE	Tréphines et perforateurs	XIV	37
MICHON	Pincers clamps	IV	46
MICRO	Ciseaux fins	III	38
MICRO ADSON	Pincers à dissection délicates	II	23
	Pincers à dissection mors tungstène	II	47
MICRO - HALSTEAD	Pincers hémostatiques	IV	20
MICRO - MOSQUITO	Pincers hémostatiques	IV	21
Microchirurgie ciseaux		X	3-11
Microchirurgie crochets		X	18-20
Microchirurgie pincers fines		X	15-17
Microchirurgie porte-aiguilles		X	12-14
MICRO-RYDER	Porte-aiguilles vasculaires	VI	21
MIDDELDORPF	Écarteurs	VII	61-62
MIKULICZ	Écarteurs	VII	54
	Pincers hémostatiques spéciales	IV	48-49
MILLER	O.R.L. râpes	XII	44
MILLES	Microchirurgie ciseaux	X	9
MILLIGAN	Rugines et dissecteurs	XIII	28
MILLIN	Écarteurs	VII	93
	Instruments pour prostate	VIII	95
MILLS	Ciseaux pour chirurgie vasculaire	III	35
MINI GEMINI	Pincers passe-fils, dissecteurs	IV	57
MINI FRIEDMANN	Pincers gouges	XIII	101
MINI LANGENBECK	Écarteurs	VII	16
MINI LEXER	Ciseaux ostéotomes, gouges	XIII	81
MINI TOWNSEND	Pincers à biopsie	VIII	67
MIRIZZI	Pincers pour calculs biliaires	IX	4-5
Miroir laryngien		XV	8
MITCHELL	Rugines	XIII	42
MIXTER	Ciseaux fins	III	14
	Pincers passe-fils, dissecteurs	IV	58-59
MIXTER-O'SHAUGNESSY	Pincers passe-fils, dissecteurs	IV	58
MOHR	Pincers diverses	IV	110
MOLT	Rugines et dissecteurs	XIII	27
MONOD	Trocarts	XV	28
MONESTRUC	Écarteurs	VII	87
MOORE	Curettes pour voies biliaires	IX	13
	O.R.L. pincers et cisaille	XII	34
MOORE LAMBOTTE	Écarteurs	VII	145
MOREL FATIO	Rugines et dissecteurs	XIII	27
MORRIS	Écarteurs	VII	52
MORRIS DEBAKEY	Pincers clamps vasculaires atrauma	V	24
MORSE-FAVALORO	Écarteurs	VII	105
MOSQUITO	Pincers hémostatiques	IV	19
MOYNIHAN	Pincers hémostatiques	IV	36
	Pincers hémostatiques longues	IV	43
MUHLING	Rugines	XIII	40
MULLER	Phlébectomie	V	7
MURPHY	Écarteurs	VII	23
	Instrumentation de service	XV	20
	Instrumentation pour genou	XIII	156
	Pincers presse tube	IV	112
MUSEUX	Daviers	XIII	142
	Pincers utérines	VIII	7-8
MUSEUX PALMER	Pincers utérines	VIII	9
MUSEUX PALMER-CHERON	Pincers utérines	VIII	9
MYERS	Strippers	V	5
MYRTLE	Sondes cannelées	XV	13
NABATOFF	Strippers	V	5
NAGELE	Forceps spatules	VIII	56
NANCY	Ciseaux divers	III	27
	Ciseaux gouges	XIII	78
NEFF	Instrumentation pour ménisque	XIII	151
NEGUS	Pincers clamps intestinales et stomacales	IV	69
NEIVERT	Porte-aiguilles	VI	14
NELATON	Bistouris fixes	I	2
	Sondes cannelées	XV	13
	Tréphines et perforateurs	XIV	37



		Chapitre	Page
NELSON	Trocarts	XV	29
NEW ORLEANS	Porte-aiguilles	VI	17
NEW SUTURE	Ciseaux à incision	III	28
NICOLLET-KOCHER	Instrumentation pour ménisque	XIII	153
NICOLLET-MUSEUX	Instrumentation pour ménisque	XIII	153
NISSEN	Instruments pour voies biliaires	IX	11
	Pincés hémostatiques	IV	35
NORFOLK-NORWICH	Écarteurs	VII	117
NORTHFIELD	Pincés gouges	XIII	107
NOTO	Pincés utérines	VIII	28
NOTTER	Divers	VIII	60
NOVAC	Divers	VIII	80
NOYES	Microchirurgie ciseaux	X	6
NUBOER	Canules aspiratrices	XV	26
NUSSBAUM	Pincés clamps intestinales et stomacales	IV	78
	O.R.L. aiguilles à paracentèse	XII	22
	O.R.L. amygdalotome	XII	26
	O.R.L. burins et gouges	XII	37-38
	O.R.L. canules aspiratrices	XII	57-58
	O.R.L. couteaux à végétations	XII	23-24
	O.R.L. couteaux spatules	XII	25
	O.R.L. crochets	XII	45-57
	O.R.L. curettes	XII	55-56
	O.R.L. diapasons	XII	59-60
	O.R.L. dilataateurs	XII	12
	O.R.L. écarteurs	XII	48
	O.R.L. écarteurs et crochets	XII	49
	O.R.L. élévateurs	XII	50-51
	O.R.L. emporte pièces	XII	27-29
	O.R.L. gouges	XII	40
	O.R.L. Instruments de Joseph	XII	52-53
	O.R.L. maillets et curettes	XII	54
	O.R.L. micro instruments	XII	33
	O.R.L. ostéotomes	XII	39
	O.R.L. ouvre-bouche	XII	7-11
	O.R.L. pincés à polypes	XII	30
	O.R.L. pincés à préhension	XII	13-15
	O.R.L. pincés à repositionner	XII	35
	O.R.L. pincés et cisaille	XII	34
	O.R.L. pincés pour oesophagoscopie	XII	36
	O.R.L. pincés pour oreilles	XII	31-32
	O.R.L. râpes	XII	42-44
	O.R.L. rugines	XII	41
	O.R.L. Serre-noeuds	XII	20-21
	O.R.L. speculums	XII	16-19
OBWEGESER	Ciseaux ostéotomes	XIII	67
	Écarteurs	VII	63, 65
OCHSNER	Pincés clamps vasculaires atrauma	V	17
OEHLER	Pincés à dissection mors tungstène	II	45
OLIVECRONA	Instrument pour amputation	XIII	20
	Pincés gouges	XIII	106
	Rugines et dissecteurs	XIII	26
	Spatules	XI	4
OLIVIER	Écarteurs	VII	82
OLLIER	Daviers	XIII	136, 140
	Écarteurs	VII	30
	Instrumentation pour genou	XIII	157
	Rugines et dissecteurs	XIII	44
OMBREDANNE	Ciseaux burins, gouges	XIII	70
	Maillets	XIII	85
	Pincés à préhension	IV	98
	Poinçons	XIII	91
OPEN COELIO	Écarteurs	VII	33
OSCHNER	Pincés à dissection délicates	II	33
O'SHAUGNESSY	Instruments pour prostate	VIII	95
	Pincés passe-fils, dissecteurs	IV	51-53
O'SULIVAN - O'CONNOR	Écarteurs	VII	85
OUPET	Pincés clamps	IV	47
OVERHOLT-GEISSENDORFER	Pincés passe-fils, dissecteurs	IV	54
OVERHOLT-MIXTER	Pincés passe-fils, dissecteurs	IV	61
OVERHOLT-S	Pincés passe-fils, dissecteurs	IV	55
OVERHOLT-SLIM	Pincés passe-fils, dissecteurs	IV	55
PAJOT	Forceps spatules	VIII	55
PALMER	Dilatateurs utérins	VIII	82
	Écarteurs	VII	78
	Pincés utérines à polypes	VIII	11
PARKER	Écarteurs	VII	35
PARKER LANGENBECK (US ARMY)	Écarteurs	VII	35
PARKER-MOTT	Écarteurs	VII	36
PARTSCH	Ciseaux burins, gouges	XIII	68
	Maillets	XIII	85



		Chapitre	Page
PARTSCH (HAUTANT)	O.R.L. burins et gouges	XII	38
PASSOW	Chasse-greffons	XIII	144
PATTERSON	Pincés à biopsie	VIII	66
PAUCHET	Instruments à sutures	VI	5
PAUCHET (SABRE)	Aiguilles à ligatures	VI	29
PAYR	Instruments à ligatures	VI	34
	Pincés clamps intestinales et stomacales	IV	75
PAYR (BABY)	Pincés clamps intestinales et stomacales	IV	75
PEAN	Instrumentation de service	XV	17
	Pincés à pansements	IV	118
	Trocarts	XV	30
PEDERSON	Spéculum vaginaux	VIII	35
PEERS	Pincés à champs	IV	105
PEET	Pincés à échardes	II	52
PELKMANN	Pincés à pansements	IV	127
	Pelvimètres	VIII	78
PENFIELD	Rugines et dissecteurs	XIII	30
PENNINGTON	O.R.L. rugines	XII	41
	Pincés à préhension	IV	89
PENNYBACKER	Pincés gouges	XIII	107
	Rugines	XIII	42
PERCY	Instrument pour amputation	XIII	21
	Perforateur	XI	9-10
	Perforateurs manuels	XIV	9
PERRY	Pincés à dissection délicates	II	37
PERTHES	Poinçons	XIII	93
PETIT DUTAILLY	Rugines et dissecteurs	XIII	37
PHANEUF	Pincés utérines	VIII	22
	Phlébectomie	V	7-8
PINARD	Marteaux à réflexes, Stéthoscope	XV	5
	Pince hystérolable	VIII	52
	Pince pour plâtres	XV	23-24
	Pincés à biopsie	VIII	62-67
	Pincés à biopsie rectale	VIII	92
	Pincés à champs	IV	103-107
	Pincés à couper les fils	XIV	30-36
	Pincés à dissection délicates	II	14-15, 22-33, 37
	Pincés à dissection étroites	II	8
	Pincés à dissection mors tungstène	II	44-47
	Pincés à dissection moyennes	II	7
	Pincés à dissection O.R.L.	II	38-40
	Pincés à dissection ophtalmologiques	II	36
	Pincés à dissection Prestige	II	48-50
	Pincés à dissection spéciales	II	12-21, 34-35
	Pincés à dissection standards	II	5-6
	Pincés à dissection très fines	II	11
	Pincés à dissection vasculaires	II	41-43
	Pincés à échardes	II	51-52
	Pincés à fils métalliques	XIV	28-29
	Pincés à pansements	IV	118-127
	Pincés à préhension	IV	81-102
	Pincés clamps	IV	46-47
	Pincés clamps intestinales et stomacales	IV	68-80
	Pincés clamps nouveau né et pédiatrique	V	37-39
	Pincés clamps vasculaires atrauma	V	12-37
	Pincés coupantes	XIII	116-120
	Pincés courbes à dissection fines	II	10
	Pincés droites à dissection fines	II	9
	Pincés emporte pièces	XI	16-23
	Pincés gouges	XIII	97-115
	Pincés hémorroïdales	VIII	94
	Pincés hémostatiques	IV	9-36
	Pincés hémostatiques longues	IV	37-43
	Pincés hémostatiques Prestige	IV	113-117
	Pincés hémostatiques spéciales	IV	14, 44-49
	Pincés multiservices	XIV	27
	Pincés passe-fils, dissecteurs	IV	50-67
	Pincés pour calculs biliaires	IX	4-7
	Pincés pour calculs rénaux	IX	3
	Pincés pour vasectomie	VIII	93
	Pincés presse tube	IV	111-112
	Pincés rongeurs	XI	11-15
	Pincés spécifiques	XIV	25-26
	Pincés utérines	VIII	7-30
	Pincés utérines à polypes	VIII	11
PIPER	Forceps spatules	VIII	58
PIRON	Curettes utérines	VIII	75
PLESTER	Écarteurs	VII	113
	O.R.L. canules aspiratrices	XII	57
	Poinçons	XIII	91-93
	Poinçons et trépan	XIII	94



		Chapitre	Page
POIRIER	Ciseaux burins, gouges	XIII	70
POLITZER	Pincés à dissection O.R.L.	II	39
POLOSSON	Écarteurs	VII	56
POOLE	Canules aspiratrices	XV	26
Porte-aiguilles		VI	8-26
Porte-aiguilles vasculaires		VI	20-22
Porte-coton		XV	14
POSTEL	Écarteurs	VII	146
	Instrument pour amputation	XIII	18
POTTS DE MARTEL	Ciseaux pour chirurgie vasculaire	III	35
POTTS-SMITH	Ciseaux divers	III	37
	Ciseaux en tungstène	III	69
	Ciseaux pour chirurgie vasculaire	III	32, 36
	Ciseaux Prestige	III	74
	Pincés à dissection délicates	II	26
	Pincés à dissection mors tungstène	II	46
POZZI	Curettes utérines	VIII	76
	Instrumentation pour épaule	XIII	148
	Pincés utérines	VIII	12
POZZI CHERON	Divers	VIII	80
POZZI PALMER	Pincés utérines	VIII	12
PRATT	Dilatateurs utérins	VIII	84
	Pincés à préhension	IV	102
	Pincés utérines	VIII	25
	Spéculums rectaux	VIII	87
PRECELLE	Pincés à dissection délicates	II	37
PRICE THOMAS	Pincés à préhension	IV	81
PRINCE	Ciseaux divers	III	37
PROVIDENCE	Pincés hémostatiques	IV	26
PUTTI	Râpes	XIII	84
QUENU	Pincés à dissection spéciales	II	20
	Pincés clamps intestinales et stomacales	IV	68
QUILICY FAR ISSE	Pincés passe-fils, dissecteurs	IV	62
QUINBY	Ciseaux divers	III	45
QUIRE	O.R.L. pincés pour oreilles	XII	32
RACHIS NOGENT	Écarteurs	VII	106
RAGNEL (DAVIS)	Écarteurs	VII	19
RALK	Perforateurs manuels	XIV	9
RAMPLEY	Pincés à pansements	IV	123
RAMUS	Écarteurs	VII	65
RANDALL	Pincés pour calculs rénaux	IX	3
Râpes		XIII	84
RECAMIER	Curettes utérines	VIII	74
REDON	Aiguilles à ligatures	VI	30
	Pincés passe-fils, dissecteurs	IV	50
RESANO	Pincés passe-fils, dissecteurs	IV	67
REVERDIN	Aiguilles à sutures	VI	27
REVERDIN (PAUCHET)	Écarteurs	VII	39
REVERSIBLE	Écarteurs	VII	101
REYNOLDS	Ciseaux longs et fins	III	46
	Ciseaux Prestige	III	73
RICARD	Écarteurs	VII	73, 75
RICARD-BEGOIN	Écarteurs	VII	74
RICHARDSON	Écarteurs	VII	50
RICHARDSON-EASTMAN	Écarteurs	VII	50
RICHTER	Ciseaux à incision	III	28
RIZZUTI	Rugines et dissecteurs	XIII	26
ROBB	Rugines et dissecteurs	XIII	29
ROBERTS	Pincés hémostatiques longues	IV	41
ROBIN	O.R.L. burins et gouges	XII	37
ROCHARD	Écarteurs	VII	67-68
	Pincés utérines	VIII	26
ROCHER	Poinçons et trépan	XIII	94
ROCHESTER-CARMALT	Pincés hémostatiques spéciales	IV	14
ROCHESTER-OSCHNER	Pincés hémostatiques	IV	13
ROCHESTER-PEAN	Pincés hémostatiques	IV	12
ROEDER	Pincés à champs	IV	107
ROGERS	Pincés utérines	VIII	18
ROLLET	O.R.L. crochets	XII	46
ROSE	Écarteurs	VII	15
RÖTTGEN-RUSKIN	Pincés gouges	XIII	112
ROUENNAIS	Ciseaux divers	III	55
ROUX	Écarteurs	VII	34
	Rugines	XIII	47
ROWE	O.R.L. pincés à repositionner	XII	35
RUALT	O.R.L. couteaux spatules	XII	25
RUBIN	O.R.L. pincés et cisaille	XII	34
Rugines		XIII	38-43, 46-51
Rugines et dissecteurs		XIII	26-37, 44-45
RUMEL	Pincés passe-fils, dissecteurs	IV	63
RUMEL BELMONT	Phlébectomie	V	7



		Chapitre	Page
RUSKIN	Pincès gouges	XIII	110
RUSKIN-LISTON	Pincès coupantes	XIII	118
RUSSIAN MODEL	Pincès à dissection spéciales	II	17
RYDER	Porte-aiguilles vasculaires	VI	21
SACHS	Rugines et dissecteurs	XIII	36
SAENGER	Pincès utérines	VIII	30
SANTORINI	Instruments pour prostate	VIII	95
SANTULLI	Clamps bulldog	V	10
SANTY	Canules aspiratrices	XV	26
	Pincès hémostatiques longues	IV	42
SANVENERO	Ciseaux longs et fins	III	49
SAROT	Pincès hémostatiques longues	IV	41
	Porte-aiguilles vasculaires	VI	22
SATINSKY	Ciseaux divers	III	50
	Pincès à préhension	IV	82
	Pincès clamps vasculaires atrauma	V	22
SATTERLEE	Instrument pour amputation	XIII	18
SAUERBRUCH	Costotomes	XIII	124
	Écarteurs	VII	51, 53
	Pincès gouges	XIII	114
SAUERBRUCH-FREY	Costotomes	XIII	124
SCHADEL	Pincès à champs	IV	103
SCHAEDE	Curettes	XIII	57
SCHAEBE	Pincès clamps intestinales et stomacales	IV	70
SCHERBAK	Spéculums vaginaux	VIII	50
SCHINK	Dermatome à main	I	8
SCHMID	Sondes et Spatules	V	6
SCHNIDT	Pincès passe-fils, dissecteurs	IV	56
SCHOEMAKER-LOTH	Ciseaux pour couper les fils	III	31
SCHRÖDER	Curettes utérines	VIII	72
SCHROEDER	Pincès utérines	VIII	13-14
SCHULTZE	Divers	VIII	79
SCHUMACHER	Ciseaux pour le cordon ombilical	III	80
	Écarteurs	VII	138
	Pincès à biopsie	VIII	63
SCHUMACHER (WAGNER)	Écarteurs	VII	138
SCHUMAKER	Pincès à biopsie	VIII	65
	Scie coupe-bague	XV	11
SCOVILLE	Curettes	XIII	63
SCUDDER	Pincès clamps intestinales et stomacales	IV	78
SEBILEAU	O.R.L. maillets et curettes	XII	54
	O.R.L. rugines	XII	41
	Rugines et dissecteurs	XIII	34
SEDILLOT	Rugines	XIII	43
SEGOND	Écarteurs	VII	55
	Pincès utérines	VIII	19
SEGOND-LANDAU	Pincès utérines	VIII	19
SEGURA	O.R.L. maillets et curettes	XII	54
SELLORS	Écarteurs	VII	109
SEMB	Daviers	XIII	138
	Pincès coupantes	XIII	120
	Pincès gouges	XIII	115
	Pincès passe-fils, dissecteurs	IV	64
	Rugines	XIII	47
SEMB-SAYLOR	Pincès passe-fils, dissecteurs	IV	64
SEMKEN	Pincès à dissection délicates	II	32
	Pincès à dissection mors tungstène	II	47
SEMM	Écarteurs	VII	85
	Spéculums vaginaux	VIII	35
SENN GREEN (CHIGOT)	Écarteurs	VII	16
SENN-MILLER	Écarteurs	VII	19
SENN-MILLER BABY	Écarteurs	VII	19
SETTER	Daviers	XIII	137
SEUTIN	Ciseaux pour plâtres	XV	22
	Pincès diverses	XV	21
SEWALL	Rugines et dissecteurs	XIII	36
SEYFFERT	Spéculums vaginaux	VIII	35
SHUBERT	Pincès à biopsie	VIII	62
SICARD	Pincès gouges	XIII	99
SICART	Rugines et dissecteurs	XIII	37
SIEBOLD	Ciseaux divers	III	50
SIMON	Curettes utérines	VIII	70
	Écarteurs	VII	51
SIMPSON	Forceps spatules	VIII	57
SIMPSON BRAUN	Forceps spatules	VIII	58
SIMPSON LU IKART	Forceps spatules	VIII	59
SIMS	Bistouris fixes	I	2
	Ciseaux en tungstène	III	68
	Ciseaux pour intervention en profondeur	III	52
	Ciseaux Prestige	III	76
	Curettes utérines	VIII	73



		Chapitre	Page
SIMS	Hysteromètres	VIII	85
	Spéculums rectaux	VIII	88
	Valves vaginales	VIII	45
SIMS-MAIER	Pincés à pansements	IV	127
SINGLEY TUTTLE	Pincés à dissection spéciales	II	21
SISTERON	Pincés pour calculs biliaires	IX	6
SKID MURPHY	Écarteurs	VII	145
SLUDDER-BALLENGER	O.R.L. amygdalotome	XII	26
SMILLIE-TRILLAT	Instrumentation pour ménisque	XIII	151-152
SMITH	Ciseaux divers	III	87
SMITH PETERSEN	Ciseaux gouges	XIII	78
SMITH-PETERSEN	Ciseaux burins, ostéotomes, gouges	XIII	71-72
	Pincés gouges	XIII	112
SNELLEN	O.R.L. curettes	XII	55
SOMMER	Pince hystérolable	VIII	52
Sondes cannelées		XV	13
Sondes et Spatules		V	6
Spatules		XI	3-5
Spéculums rectaux		VIII	87-88
Spéculums vaginaux		VIII	31-35, 50
SPENCER	Ciseaux coupe ligatures	III	41
SPENCER WELLS	Pincés hémostatiques	IV	15, 18
SPENCER-FINO	Ciseaux coupe ligatures	III	42
SPINA-NASALIS	Écarteurs	VII	65
ST MARKS	Valves vaginales	VIII	47
STAGNARA	Ciseaux gouges	XIII	80
STAMEY	Aiguilles à ligatures	VI	29
STANDARD	Trocarts	XV	29
STEINMANN	Chirurgie des tendons	XIII	13-14
STELLBRINK	Pincés gouges	XIII	105
STERNAL	Écarteurs	VII	101
STERNBERG	O.R.L. ouvre-bouche	XII	8
STEVENS	Ciseaux fins	III	43
	Ciseaux Prestige	III	73
	Ciseaux fins	III	43
STEVENS (RIBBON TYPE)			
STIEGLITZ	Pincés à échardes	II	52
STILLE	Ciseaux burins, ostéotomes, gouges	XIII	73
	Instruments pour voies biliaires	IX	9
	Pince pour plâtres	XV	23
	Pincés à dissection délicates	II	15
	Pincés gouges	XIII	111
	Pincés gouges	XIII	115
STILLE-LUER	Pincés gouges	XIII	108
STOOKEY	Pincés gouges	XIII	108
STRANDELL-STILLE	Écarteurs	VII	17
STRASBOURG	Pincés à dissection spéciales	II	13
STRATT	Porte-aiguilles	VI	19
STRAUSS	Instruments pour urologie	VIII	86
STRELI	Porte-aiguilles	VI	9
	Strippers	V	5
STRUCK	Écarteurs	VII	104
STRULLY	Ciseaux longs et fins	III	48
STRUYCKEN	O.R.L. emporte pièces	XII	28
Stylets		XV	12
SUBRAMANIAN	Pincés clamps vasculaires atrauma	V	31
SYME	Rugines et dissecteurs	XIII	29
TAKAHASHI	O.R.L. emporte pièces	XII	28
TAKAHASHI	O.R.L. râpes	XII	42
Tarauts		XIV	6
TARNIER	Forceps spatules	VIII	53
TAYLOR	Écarteurs	XI	7
	Pincés à dissection délicates	II	27
	Pincés utérines	VIII	10
TEALE	Forceps spatules	VIII	59
TEISSIER	Bistouris fixes	I	2
TENOTOME	O.R.L. ouvre-bouche	XII	7
TERRIER	Pincés hémostatiques	IV	15-16
	Écarteurs	VII	66, 110
TESSIER	Divers	VIII	81
THERUM	Pincés à préhension	IV	97
THOMS-ALLIS	O.R.L. speculums	XII	17
THUDICHUM (GOLDSMITH)	O.R.L. speculums	XII	19
TIECK	Pincés à biopsie	VIII	67
TISCHLER	Pincés à biopsie	VIII	64
TISCHLER-MORGAN	Ciseaux longs et fins	III	47
TOENNIS	Rugines et dissecteurs	XIII	31
	Ciseaux en tungstène	III	65
	Ciseaux longs et fins	III	47
TOENNIS-ADSON	Ciseaux longs et fins	III	47
TOENNIS-ADSON-FINO	Pincés à champs	IV	106
TOHOKU	Écarteurs	VII	72, 76
TOUPET	Écarteurs	VII	76
TOUPET (ENTEROSTAT)	Écarteurs	VII	76



		Chapitre	Page
Tournevis		XIV	11-13
TOWNSEND	Pincés à biopsie	VIII	67
TRAVERS	Écarteurs	VII	115
TRELAT	Spéculems rectaux	VIII	87
Tréphines et perforateurs		XIV	37
TREVES	Pincés à dissection spéciales	II	12
TRILLAT	Chasse-greffons	XIII	144
	Écarteurs	VII	143
	Instrumentation pour épaule	XIII	149
	Instrumentation pour genou	XIII	156
	Instrumentation pour ménisque	XIII	155
Trocarts		XV	28-30
TROELTSCH	Pincés à dissection O.R.L.	II	38
TROUSSEAU	O.R.L. dilateurs	XII	12
TROUTMAN	Microchirurgie ciseaux	X	7
TROUTMAN-BARRAQUER	Microchirurgie ciseaux	X	5
TUBBS	Dilateurs vasculaires	V	40
TUBIANA	Porte-aiguilles	VI	9
TUFFIER	Écarteurs	VII	38, 49
	Pincés à préhension	IV	98
TULIPE	Phlébectomie	V	7
UCKERMANN	O.R.L. dilateurs	XII	12
UFFENORDE	Curettes	XIII	58
ULRICH	Daviers	XIII	131
	Pincés à pansements	IV	121
UNIVERSAL	Trocarts	XV	29
UNIVERSAL	Ciseaux pour couper les fils	III	31
UNNA	Curettes	XIII	53
USA MODEL	Pince pour plâtres	XV	23
VACHER	O.R.L. Serre-noeuds	XII	20
	O.R.L. speculums	XII	16
VALLEIX	Hysteromètres	VIII	85
Valves		VII	57
Valves vaginales		VIII	37-49
VAN DOREN	Pincés à biopsie	VIII	63
VANNAS	Microchirurgie ciseaux	X	4, 9-10
VARADY	Phlébectomie	V	8
VELPEAU (TRICOISE)	Costotomes	XIII	125
Ventouse obstétricale		VIII	61
VERBRUGGE	Daviers	XIII	127-130
VERBRUGGE-MULLER	Écarteurs	VII	136
VERNON	Marteaux à réflexes, Stéthoscope	XV	5
VIDAL	Curettes	XIII	52
VINCENT	Ciseaux pour chirurgie vasculaire	III	36
	Pincés à dissection Prestige	II	49
	Pincés gouges	XIII	99
VIRCHOW	Instrument pour amputation	XIII	15, 17
VISE	Pincés à dissection délicates	II	33
VOLKMANN	Curettes	XIII	54-57
	Curettes utérines	VIII	71
	Écarteurs	VII	22-25
WACHENFELDT	Instruments à sutures	VI	5
WAGENER	O.R.L. crochets	XII	45
WAGNER	Ciseaux fins	III	14
	Ciseaux Prestige	III	72
	Écarteurs	VII	133
	Rugines	XIII	51
WALDMANN	Ciseaux à épisiotomie	III	82
WALLICH	Curettes utérines	VIII	69
WALSHAM	O.R.L. pincés à repositionner	XII	35
WALTER -DUVAL	Pincés à préhension	IV	86
WALTER-CARMALT	Pincés à échardes	II	51
WALTON	Ciseaux fins	III	40
	Écarteurs	VII	127
WANGENSTEEN	Pincés à dissection mors tungstène	II	45
	Porte-aiguilles	VI	17
WATSON CHEYNE	Rugines et dissecteurs	XIII	31
	Stylets	XV	12
WAUGH	Pincés à dissection délicates	II	31
WEBSTER	Porte-aiguilles	VI	8
WECKER	Microchirurgie ciseaux	X	6
WEIL-BLAKESLEY	Pincés rongeurs	XI	15
WEISS	Pincés presse tube	IV	111
WEITLANER	Écarteurs	VII	114-115
WEITLANER (MOLLISON)	Écarteurs	VII	118
WEITLANER-NEURO	Écarteurs	VII	119
WEITLANER-WULLSTEIN	Écarteurs	VII	118
WERTHEIM	Ciseaux pour intervention en profondeur	III	52
	Pincés utérines	VIII	16, 20
WERTHEIM (BOZEMANN)	Porte-aiguilles	VI	19
WERTHEIM CULLEN	Pincés utérines	VIII	23



		Chapitre	Page
WERTHEIMER	O.R.L. canules aspiratrices	XII	57
WESTCOTT	Microchirurgie ciseaux	X	3, 7
WHITE	O.R.L. pinces à préhension	XII	13
WHITEHEAD	O.R.L. ouvre-bouche	XII	9
WICKSTROEM	Pincés passe-fils, dissecteurs	IV	59
WIEN	O.R.L. speculums	XII	19
WILLIAMS	Écarteurs	VII	129
WILLIGER	Curettes	XIII	53
	O.R.L. curettes	XII	56
	Rugines et dissecteurs	XIII	35
WILMER	Ciseaux fins	III	39
WINTER	Pincés utérines	VIII	29
WOLF	Pince pour plâtres	XV	23
WOODSON	Rugines et dissecteurs	XIII	28
WRIGLEY	Forceps spatules	VIII	57
WYLIE	Pincés clamps vasculaires atrauma	V	16
YANKAUER	Canules aspiratrices	XV	26
	Rugines et dissecteurs	XIII	34
YASARGIL	Microchirurgie ciseaux	X	11
	Microchirurgie porte-aiguilles	X	13
	Rugines et dissecteurs	XIII	31
YEOMAN	Pincés à biopsie rectale	VIII	92
YOUNG	Instrumentation de service	XV	9
	Instruments pour prostate	VIII	96
ZENKER	Écarteurs	VII	48
	Pincés passe-fils, dissecteurs	IV	60
ZIELKE	Ciseaux gouges	XIII	83
ZWEIFEL	Porte-aiguilles	VI	26



		Chapter	Page
AACHEN	Spatulas	XI	5
ABADIE	Retractors	VII	91
ABOULKER	Bone rongeur forceps	XIII	100
	E.N.T. dilators	XII	12
	Raspatories and elevators	XIII	32
	Retractors	VII	11
ABRAHAM	E.N.T. knives spatula	XII	25
ADLERKREUTZ	Prestige dissecting forceps	II	50
	Special dissecting forceps	II	16
ADSON	Bone rongeur forceps	XIII	104
	Delicate dissecting forceps	II	22
	Dissecting forceps with tungsten jaws	II	47
	Haemostatic forceps	IV	35
	Hooks	XIII	24
	Instrumentation for services	XV	17
	Needle holders	VI	10
	Raspatories	XIII	38
	Retractors	VII	124, 126
ADSON ATRAUMA	Delicate dissecting forceps	II	24
ADSON BIMER	Delicate dissecting forceps	II	24
ADSON BROWN	Delicate dissecting forceps	II	22
ADSON GRAEFE	Delicate dissecting forceps	II	24
ALAN PARKS	Rectal retractors	VIII	91
ALEXANDER	Bone chisels, ostéotomes, gouges	XIII	71
	Raspatories and elevators	XIII	29
ALLAINE	Dissecting scissors	III	25-26
	Ligature forceps, dissectors	IV	53
ALLAIRE	Delicate scissors	III	15
ALLEN	Intestinal and stomach clamp forceps	IV	77
ALLIS	Grasping forceps	IV	94
ALLIS-ADAIR	Grasping forceps	IV	96
ALLISON	Retractors	VII	40
ALM	Retractors	VII	111
Amnioscopes		VIII	51
ANDERSON-ADSON	Retractors	VII	119
ANDREW PYNCHON	Suction tubes	XV	26
Anuscopes		VIII	89
ARNOUS	Retractors	VII	55
ARRUGA	Microsurgery fine forceps	X	16
ASCH	E.N.T. forceps and shear	XII	34
Atrauma vascular forceps		V	12-37
AUBERT (FINSTERER)	Suction tubes	XV	26
AUBRY (EN Z)	E.N.T. retractors	XII	48
AUFRICHT	E.N.T. rasps	XII	43
	E.N.T. retractors and hooks	XII	49
AUSTIN	Delicate dissecting forceps	II	33
AUVARD	Vaginal blades	VIII	49
AUVERT	Grasping forceps	IV	92
	Retractors	VII	86
BABCOCK	Grasping forceps	IV	100-101
BABCOCK (BABY)	Grasping forceps	IV	100
BABINSKY	Percussion hammers, Stethoscope	XV	5
BABY CRILE-WOOD	Needle holders	VI	15
BABY METZENBAUM	Prestige scissors	III	71
BABY POOLE	Suction tubes	XV	26
BABY SATINSKY	Grasping forceps	IV	82
BABY-ADSON	Ligature forceps, dissectors	IV	50
BABY-ALLIS	Grasping forceps	IV	95
BABY-COLLIN	Retractors	VII	81
BABY-CRILE	Haemostatic forceps	IV	30
BABY-DOYEN	Intestinal and stomach clamp forceps	IV	70
BABY-HAIGHT	Retractors	VII	98
BABY-KOCHER	Intestinal and stomach clamp forceps	IV	70
BABY-LEXER	Dissecting scissors	III	21
BABY-MIXTER	Ligature forceps, dissectors	IV	58
BABY-OVERHOLT	Ligature forceps, dissectors	IV	58
BABY-ROUX	Retractors	VII	34
BABY-TISCHLER (MINI-TO WNSSEND)	Biopsy forceps	VIII	64
BACKHAUS	Instrumentation for services	XV	20
	Towel forceps	IV	104-105
BACON	Bone rongeur forceps	XIII	108
BAILEY	Retractors	VII	109
BAILEY-BABY	Retractors	VII	109
BAINBRIDGE	Atrauma vascular forceps	V	14
	Special haemostatic forceps	IV	44
BAKES	Dilators for bile ducts	IX	14
BALFOUR	Retractors	VII	89-90
BALFOUR (USA-MODEL)	Retractors	VII	91
BALLENGER	E.N.T. adenoids knives	XII	24
	E.N.T. gouges	XII	40
BALLENTINE	Uterines forceps	VIII	22



	Chapter	Page
Bandage forceps	IV	118-127
Bandage scissors	III	29-30
BANE HARTMANN	Bone rongeur forceps	XIII
BANKART	Shoulder instrumentation	XIII
BAR	Miscellaneous	VIII
BARR	Rectal retractors	VIII
BARRAQUER	Microsurgery needle-holders	X
BARRAYA	Delicate dissecting forceps	II
	Ligature forceps, dissectors	IV
	Prestige dissecting forceps	II
BARRE	Instruments for bile ducts	IX
BARSKY	Retractors, hooks	VII
BARTH	Curettes	XIII
BECK	Atrauma vascular forceps	V
BECKMANN	E.N.T. adenoids knives	XII
	Retractors	VII
BECKMANN (MOORE)	E.N.T. adenoids knives	XII
BECKMANN-ADSON	Retractors	VII
BECKMANN-CONE	Retractors	VII
BECKMANN-EATON	Retractors	VII
BECKMANN-GOITER	Retractors	VII
BECKMANN-STILLE	Retractors	VII
BEEBE	Wire cutting scissors	III
BELLUCI	E.N.T. micro instruments	XII
BENGOLEA	Long haemostatic forceps	IV
	Prestige Haemostatic forceps	IV
BENNET	Retractors	VII
BENSAUDE	Anuscopes	VIII
BENSON	Grasping forceps	IV
BERGER	Biopsy forceps	VIII
BERGERET TOUPET	Retractors	VII
BERGMANN	Bandage scissors	III
	Mallets	XIII
	Retractors, hooks	VII
BERNHARD	Towel forceps	IV
BESNIER	Curettes	XIII
BETHUNE	Costotomes	XIII
BEYER	Bone rongeur forceps	XIII
BEYER-ZAUFAL	Bone rongeur forceps	XIII
BILLEAU	E.N.T. curettes	XII
Biopsy forceps		VIII
BIRCHER	Instrumentation for meniscus	XIII
BIRCHER-GANSKE	Instrumentation for meniscus	XIII
BIRKETT	Haemostatic forceps	IV
Blades		VII
BLAKE	Forceps gales stones	IX
	Uterines curettes	VII
BLONDIAU	E.N.T. mallets and curettes	XII
BLOUNT	Instrumentation for meniscus	XIII
	Retractors	VII
BLUMENTHAL	Bone rongeur forceps	XIII
BOEHLER	Bone cutting forceps	XIII
	Bone rongeur forceps	XIII
	Traction bows	XIII
	Various scissors	III
BOETTCHER		XIII
Bone chisels, gouges		XIII
Bone chisels, ostéotomes, gouges		XIII
Bone cutting forceps		XIII
Bone drill		XI
Bone hand drills		XIV
Bone holding forceps		XIII
Bone rongeur forceps		XIII
Bone surgery scissors		III
BONN	Fine scissors	III
BONNAIRE	Uterines forceps	VIII
BONNEY	Special dissecting forceps	II
BONNIOT	Haemostatic forceps	IV
BORDIER-MEUNIER	Trocars	XV
BOSE	E.N.T. specula	XII
BOURGEOIS	E.N.T. grasping forceps	XII
BOWMAN (PALMER)	E.N.T. specula	XII
BOYS-ALLIS	Grasping forceps	IV
BOZEMANN	Bandage forceps	IV
BRAND	Surgery for tendons	XIII
BRAUN	Miscellaneous	VIII
	Uterines forceps	VIII
BRAUN-STADLER	Episiotomy scissors	III
BREISKY	Pelvimeters	VIII
	Vaginal blades	VIII
BRIDGE	Long haemostatic forceps	IV
BRISTOW	Retractors	VII



		Chapter	Page
BROCK	Curettes	XIII	52
BROPHY	Delicate dissecting forceps	II	28
	Long and fine scissors	III	49
BROWN RESANO	Special dissecting forceps	II	18
BRUENINGS	E.N.T. snares	XII	20
	Tongue depressor	XV	6
BRUNETTI	Instruments for autopsy	XIII	23
BRUNNER	Costotomes	XIII	123
	Intestinal and stomach clamp forceps	IV	76
	Ligature needles	VI	31
	Retractors	VII	45
BRUNS	Curettes	XIII	58, 62
	Plaster instruments	III	85
	Plaster scissors	XV	22
BRYANT	Bandage forceps	IV	126
BUCK	E.N.T. curettes	XII	55
	E.N.T. ear forceps	XII	32
BUCK-GRAMCKO	Retractors	VII	132
BUELAU	Trocars	XV	30
Bulldog clamps		V	9-11
BUNNEL	Bone hand drills	XIV	9
	Surgery for tendons	XIII	11-12
BUSCH (VEZIEN)	Scissors for umbilical cord	III	80
BUSCHE	Curettes	XIII	63
CAIRNS	Haemostatic forceps	IV	36
CAIRNS (CLOVIS VINCENT)	Raspatories and elevators	XIII	37
Cannulas		XV	27
CANNY-RYALL	Retractors	VII	36
CAPENER	Gouges	XIII	83
CAROLL	Surgery for tendons	XIII	13
CARPENTER	Raspatories and elevators	XIII	28
CARREL	Bulldog clamps	V	9
	Haemostatic forceps	IV	16
CASPAR	Curettes	XIII	64
	Hooks	XIII	25
	Raspatories	XIII	39
	Retractors	VII	46
	Retractors	XI	7
	Rongeurs Forceps	XI	12-13
	Scalpel handles, disposable blades	I	6
CASTANEDA	Neonatal and pediatric clamps	V	39
CASTROVIEJO	E.N.T. hooks	XII	46
	Microsurgery needle-holders	X	12
	Microsurgery scissors	X	5, 8
CATLIN	Instruments for amputation	XIII	16
CAUCHOIX	Bone chisels, gouges	XIII	77
	Retractors	VII	144
CHADWICK	Fine scissors	III	39
CHANDLER	Retractors	VII	106, 141
CHAPUT	Grasping forceps	IV	93
CHAPUT-MAYO	Grasping forceps	IV	93
CHARNLEY	Curettes	XIII	65
	Retractor, lead hands	XIII	143
CHARRIER	Retractors	VII	37
CHARRIERE	Instruments for amputation	XIII	18-19
CHATELIER	E.N.T. grasping forceps	XII	14
CHEATLE	Miscellaneous materials	XV	32
CHERON	Bandage forceps	IV	119
CHEVALIER-JACKSON	E.N.T. forceps for oesophagoscopy	XII	36
CHEVRET	Retractors	VII	40
CHRISTOPHE	Haemostatic forceps	IV	33
	Prestige Haemostatic forceps	IV	117
CHROBACK	Uterines forceps	VIII	24
Chucks		XIV	7
CINELLI	E.N.T. osteotomes	XII	39
CIRCERON (MATHIEU)	Miscellaneous	VIII	81
CITELLI	E.N.T. punch forceps	XII	27
Clamp forceps		IV	46-47
CLAOUE	E.N.T. retractors	XII	48
CLEVELAND	Bone cutting forceps	XIII	117
	Bone rongeur forceps	XIII	103
CLOVIS-VINCENT	Bone drill	XI	9
	E.N.T. curettes	XII	56
	Spatulas	XI	3
	Very fine dissecting forceps	II	11
	Raspatories	XIII	48
CLOWARD	Curettes	XIII	59
	Hooks	XIII	24
COAKLEY	E.N.T. curettes	XII	55
COBB	Raspatories	XIII	51
COLLER-CRILE	Haemostatic forceps	IV	30



		Chapter	Page	
COLLIN	Costotomes	XIII	121	
	Grasping forceps	IV	87, 90	
	Retractors	VII	34, 79-80	
	Uterine elevating forceps	VIII	52	
	Vaginal speculas	VIII	31	
COLLIN POZZI	Uterines forceps	VIII	13	
COLVER	E.N.T. grasping forceps	XII	13	
CONVERSE	E.N.T. hooks	XII	47	
	Needle holders	VI	14	
COOLEY	Atrauma vascular forceps	V	33-37	
	Neonatal and pediatric clamps	V	37-38	
	Retractors	VII	102	
	Vascular dilators	V	40	
	Vascular dissecting forceps	II	42	
COOLEY-DERRA	Atrauma vascular forceps	V	34	
CORYLLOS	Retractors	VII	53	
Costotomes		XIII	121-125	
COTT	Retractors	VII	77	
COTT (À LAMBEAUX)	Uterines forceps	VIII	24	
COTTLE	E.N.T. chisels and gouges	XII	37	
	E.N.T. hooks	XII	47	
	E.N.T. rasps	XII	43	
	ENT scissors	III	84	
	Mallets	XIII	89	
	Prestige scissors	III	79	
	Raspatories	XIII	43	
	Raspatories and elevators	XIII	31	
	Retractors, hooks	VII	10	
	E.N.T. specula	XII	18	
COTTLE (KILLIAN)	E.N.T. hooks	XII	47	
Cotton holder		XV	14	
COURTY	Retractors	VII	131	
CRAFOORD	Long haemostatic forceps	IV	43	
	Scissors for deep operation	III	51	
CRAFOORD (SELLORS)	Special haemostatic forceps	IV	45	
CRAIG-DOMNICK	E.N.T. grasping forceps	XII	15	
CRAWFORD	Retractors	VII	36	
CREED	Raspatories and elevators	XIII	28	
CRILE	Haemostatic forceps	IV	28-29	
	Hooks	XIII	25	
	Prestige Haemostatic forceps	IV	117	
	Retractors	VII	33	
	Needle holders	VI	11	
CRILE MURAY	Needle holders	VI	11, 15	
CRILE-WOOD	Instrumentation for services	XV	18	
Curettes		XIII	52-65	
Curettes for bile ducts		IX	12-13	
CUSCHING-KOCHER	Retractors	VII	17	
CUSCO	Vaginal speculas	VIII	33-34	
CUSHING	Bone drill	XI	10	
	Delicate dissecting forceps	II	25	
	Dissecting forceps with tungsten jaws	II	46	
	Hooks	XIII	25	
	Microsurgery hooks	X	20	
	Raspatories	XIII	41-42	
	Retractors	VII	13, 62	
	Uterines curettes	VIII	75	
	CUZZI	Forceps gales stones	IX	7
	CZERNY	Rectal speculas	VIII	88
Uterines forceps		VIII	25	
Atrauma vascular forceps		V	30	
DALE	Haemostatic forceps	IV	26	
DANDY	Microsurgery hooks	X	20	
	Instrumentation for ligatures	XIII	150	
DANIS	Shoulder instrumentation	XIII	149	
	Wire pliers	XIV	29	
	Uterines forceps	VIII	16	
DARGENT	Vaginal blades	VIII	42	
	Uterine elevating forceps	VIII	52	
DARTIGUES	Retractors	VII	94	
DARTIGUES (LAPAROSTAT)	Curettes	XIII	60	
DAUBENSPECK	Delicate scissors	III	12	
	Surgical scissors	III	11	
DAUPHIN	E.N.T. retractors	XII	48	
DAUTREY	Bone rongeur forceps	XIII	114	
DAVID	Raspatories and elevators	XIII	27	
DAVIS-BOYLE	E.N.T. mouth gag	XII	10	
DE MARTEL	Instruments for amputation	XIII	20	
	Raspatories and elevators	XIII	37	
	Scissors for vascular surgery	III	35	
	Intestinal and stomach clamp forceps	IV	80	
DE MARTEL - WOLFSON				



		Chapter	Page
DE MARTEL (PITANGUY)	Grasping forceps	IV	84
DEAN	Miscellaneous scissors	III	45
DEAVER	Fine scissors	III	14
	Retractors	VII	59-60
DEBAKEY	Atrauma vascular forceps	V	13-17, 20-32
	Bulldog clamps	V	10
	Dissecting forceps with tungsten jaws	II	44
	Retractors	VII	130
	Scissors for vascular surgery	III	33, 36
	Tungsten scissors	III	69
	Vascular dilators	V	40
	Vascular dissecting forceps	II	41-43
	Vascular needle holders	VI	20
DEBAKEY (LELAND JONES)	Atrauma vascular forceps	V	14
DEBAKEY BAHNSON	Atrauma vascular forceps	V	25
DEBAKEY CAROTID	Bulldog clamps	V	11
DEBAKEY DIETRICH	Vascular dissecting forceps	II	43
DEBAKEY GERALD	Vascular dissecting forceps	II	43
DEBAKEY GLOVER	Bulldog clamps	V	11
DEBAKEY MOSQUITO	Atrauma vascular forceps	V	27
DEBAKEY PEAN	Atrauma vascular forceps	V	26
DEBAKEY POTTS	Atrauma vascular forceps	V	12
DEBAKEY RANKIN	Atrauma vascular forceps	V	27
DEBAKEY SATINSKY	Bulldog clamps	V	11
DEBAKEY-BECK	Atrauma vascular forceps	V	16
DECOULX	Retractors	VII	123
DELABARRE	E.N.T. mouth gag	XII	7
DELESTRE	Episiotomy scissors	III	81
Delicate dissecting forceps		II	14-15, 22-37
Delicate scissors		III	12-15
DEMEL	Wire pliers	XIV	29
DEMELIN-SUZOR	Obstetrical forceps	VIII	54
DEMOISELLE	Grafts pusher	XIII	144
DENHART	E.N.T. mouth gag	XII	7
DENIS BROWN	Retractors	VII	84
DERF	Needle holders	VI	8, 14
DERRA	Atrauma vascular forceps	V	29
DESCHAMPS	Ligature needles	VI	32
DESCHAMPS SCHAUTA	Ligature needles	VI	31
DESGOUTTES	Special dissecting forceps	II	18
DESJARDINS	Curettes for bile ducts	IX	12
	Forceps gales stones	IX	6
	Instruments for bile ducts	IX	11
DESMARET	Retractors	VII	70
DESMARRES	Retractors	VII	11
DIETRICH	Atrauma vascular forceps	V	18
Dilators for bile ducts		IX	14
DINGMAN	Retractors	VII	66
DINGMANN	Bone holding forceps	XIII	127
	E.N.T. mouth gag	XII	11
Disposable sterile scalpels		I	7
Dissecting forceps with tungsten jaws		II	44-47
Dissecting scissors		III	16-26
DIXON-LOVELACE	Haemostatic forceps	IV	27
DOCKHORN	Retractors	VII	64
DOUAY	Biopsy forceps	VIII	65
DOUGLAS	Vaginal blades	VIII	41
DOYEN	Bone drill	XI	9
	Costotomes	XIII	125
	E.N.T. mouth gag	XII	8
	Intestinal and stomach clamp forceps	IV	69, 72
	Ligature needles	VI	28
	Miscellaneous	VIII	81
	Needle holders	VI	9
	Raspatories and elevators	XIII	45
	Retractors	VII	61
	Towel forceps	IV	103
	Uterines forceps	VIII	27
	Vaginal blades	VIII	37, 46
	Various scissors	III	27
DOYEN (COURONNE DE TREPAN)	Bone drill	XI	9
DOYEN-ROCHARD	Retractors	VII	69
Drills		XIV	5
Drills guide		XIV	14-16
DRYSSEN	Retractors	VII	107
DUBOIS	Scissors for deep operation	III	51
DUBOST	Dissecting scissors	III	20
	Retractors	VII	99
	Tungsten scissors	III	67
DUBOST NOGENT	Retractors	VII	100
DUFOURMENTEL	Delicate dissecting forceps	II	32



		Chapter	Page
DUFOURMENTEL	E.N.T. rasps	XII	42
DUMONT	Special dissecting forceps	II	35
DUNHILL	Haemostatic forceps	IV	17
DUPLAY	E.N.T. specula	XII	16
	Uterines forceps	VIII	13
DUPONT	Osteotomes	XIII	67
DURAND	Prestige dissecting forceps	II	50
	Special dissecting forceps	II	17
DUVAL	Grasping forceps	IV	89-91
	Special dissecting forceps	II	21
	E.N.T. adenoids knives	XII	23-24
	E.N.T. chisels and gouges	XII	37-38
	E.N.T. currettes	XII	55-56
	E.N.T. dilators	XII	12
	E.N.T. ear forceps	XII	31-32
	E.N.T. elevator	XII	50-51
	E.N.T. forceps and shear	XII	34
	E.N.T. forceps for oesophagoscopy	XII	36
	E.N.T. gouges	XII	40
	E.N.T. grasping forceps	XII	13-15
	E.N.T. hooks	XII	45-47
	E.N.T. Joseph's instruments	XII	52-53
	E.N.T. knives spatula	XII	25
	E.N.T. mallets and currettes	XII	54
	E.N.T. micro instruments	XII	33
	E.N.T. mouth gag	XII	7-11
	E.N.T. osteotomes	XII	39
	E.N.T. paracentesis needles	XII	22
	E.N.T. polypus forceps	XII	30
	E.N.T. punch forceps	XII	27-29
	E.N.T. raspatories	XII	41
	E.N.T. rasps	XII	42-44
	E.N.T. reposition forceps	XII	35
	E.N.T. retractors	XII	48
	E.N.T. retractors and hooks	XII	49
	E.N.T. snares	XII	20-21
	E.N.T. specula	XII	16-19
	E.N.T. suction tubes	XII	57-58
	E.N.T. tonsillotome	XII	26
	E.N.T. tuning forks	XII	59-60
ECHLIN	Bone rongeur forceps	XIII	113
EISELSBERG	Wire cutting scissors	III	31
EMMET	Bandage forceps	IV	126
	Ligature needles	VI	29
	Endospeculas	VIII	36
ENGEL	Instruments for amputation	XIII	21
ENGLISH MODEL	Special dissecting forceps	II	12
	ENT dissecting forceps	II	38-40
	ENT scissors	III	83-84
	Episiotomy scissors	III	81-82
EPPENDORF	Biopsy forceps	VIII	66
ERRICO	Bone drill	XI	10
ESMARCH	Bandage scissors	III	30
	Miscellaneous materials	XV	31
	Vascular needle holders	VI	22
EUFRATE			
EVANS	Dissecting forceps with tungsten jaws	II	45
EVES	E.N.T. snares	XII	20
FARABEUF	Bone chisels, gouges	XIII	76
	Bone holding forceps	XIII	133
	Instruments for amputation	XIII	19
	One-piece scalpels	I	2
	Raspatories and elevators	XIII	44
	Retractors	VII	31, 42
FARABEUF-CORTI	Retractors	VII	33
FARKAS	Special dissecting forceps	II	20
FAVALORO	Scissors for vascular surgery	III	36
FEILCHENFELD	Splinters forceps	II	51
FERGUSSON	Bone holding forceps	XIII	139
	E.N.T. suction tubes	XII	58
	Incision scissors	III	28
FERRIS SMITH KERRISSON	Punches forceps	XI	16-23
FERRIS-SMITH-CUSHING	Rongeurs Forceps	XI	14
FICAT	Punches and trephines	XIII	94
	Fine curved dissecting forceps	II	10
	Fine scissors	III	14, 38-44
	Fine straight dissecting forceps	II	9
FINOCHIETTO	Ligature forceps, dissectors	IV	66
	Needle holders	VI	10, 18
	Retractors	VII	95-98
FINOCHIETTO-BURFORD	Retractors	VII	107
FINSEN	Retractors	VII	111



		Chapter	Page
FISH	E.N.T. hooks	XII	45
	Hooks	XIII	24
	Probes	XV	12
Fluted directors		XV	13
FOERSTER	Bandage forceps	IV	124
FOMON	E.N.T. hooks	XII	46
	E.N.T. rasps	XII	44
	ENT scissors	III	83-84
	Prestige scissors	III	78
Forceps for kidney stones		IX	3
Forceps gales stones		IX	4-7
FRAZIER	E.N.T. suction tubes	XII	57-58
	Microsurgery hooks	X	19
	Raspatories and elevators	XIII	36
FREER	E.N.T. chisels and gouges	XII	37
	E.N.T. elevator	XII	50
	E.N.T. gouges	XII	40
	E.N.T. hooks	XII	46
	Raspatories and elevators	XIII	26
FREER-YASARGIL	Raspatories and elevators	XIII	26
FRENCH	E.N.T. tuning forks	XII	59
FRIEDMANN DELIKAT	Bone rongeur forceps	XIII	101
FRITSCH	Retractors	VII	61
FRYKHOLM	Bone rongeur forceps	XIII	113
FUCHSIG	Haemostatic forceps	IV	34
FUKUDA	Retractors	VII	142
GALLAHER	E.N.T. rasps	XII	42
GELPI	Retractors	VII	130
GEMINI	Ligature forceps, dissectors	IV	57
GERALD	Delicate dissecting forceps	II	30
GIERTZ-STILLE	Costotomes	XIII	123
GIGLI	Instruments for amputation	XIII	20
GILLIES	Delicate dissecting forceps	II	31
	Needle holders	VI	24
	Retractors, hooks	VII	9
GILLIES-BABY	Needle holders	VI	24
GIL-VERNET	Retractors	VII	12
GIL-VERNET (PAPIN)	Retractors	VII	12
GINESTET	E.N.T. retractors and hooks	XII	49
GLOVER	Atrauma vascular forceps	V	28-29
GLUCK	Costotomes	XIII	123
GOELET	Retractors	VII	34
GOLDMANN-FOX	Fine scissors	III	44
	Tungsten scissors	III	66
GOOD	Various scissors	III	37
GORNEY	Prestige scissors	III	77
GOSSET	Retractors	VII	87-88
Gouges		XIII	78-83
GOUILLOUD	Clamp forceps	IV	47
GOURDET	Uterines curettes	VIII	68
GRAEFE	Fine scissors	III	39
	Microsurgery hooks	X	18
Graft skin amplifier		I	10
Grafts pusher		XIII	144-145
GRAHAM	Microsurgery hooks	X	20
Grasping forceps		IV	81-102
GRAVE	Vaginal speculas	VIII	34
GRAY	Instruments for bile ducts	IX	10
GRAZIL	Delicate scissors	III	13
GREEN	Retractors	VII	62
GREEN-ARMYTAGE	Uterines forceps	VIII	30
GREGOIRE	Grasping forceps	IV	88
	Special dissecting forceps	II	19
GREGORY	Atrauma vascular forceps	V	31
GREGORY SOFT	Bulldog clamps	V	10
GROSS MAYER	Bandage forceps	IV	120
GRUENWALD	Dissecting forceps with tungsten jaws	II	46
	E.N.T. punch forceps	XII	28
GUERRIER	E.N.T. retractors and hooks	XII	49
Guide for reamers and nails IM		XIV	39
GUILLAUME	Gouges	XIII	78
GUNNAR-HEY	Miscellaneous forceps	IV	108
GUTHRIE	Microsurgery hooks	X	19
GUYON	Instruments for kidney pedicle	IX	8
	Instruments for urology	VIII	86
GUYON-FREUDENBERG	Miscellaneous materials	XV	32
HABERER	Retractors	VII	38
Haemorrhoidal forceps		VIII	94
Haemostatic forceps		IV	9-36
HAIGHT	Retractors	VII	102
HAJEK	E.N.T. punch forceps	XII	28



		Chapter	Page
HAJEK	Mallets	XIII	87
HAKANSSON	Bone rongeur forceps	XIII	103
HALLE	Curettes	XIII	60
	ENT scissors	III	83
	Raspatories and elevators	XIII	32
	Rectal retractors	VIII	90
HALSEY	Needle holders	VI	8
HALSEY (WEBSTER)	Needle holders	VI	13
HALSTEAD	Haemostatic forceps	IV	20
	Instrumentation for services	XV	19
	Prestige Haemostatic forceps	IV	113
HALSTEAD-MOSQUITO	Haemostatic forceps	IV	23
Hand dermatome		I	8-9
HANK	Uterine dilators	VIII	84
HARKEN	Atrauma vascular forceps	V	18
	Grasping forceps	IV	83
HARRINGTON	Ligature forceps, dissectors	IV	67
	Retractors	VII	58
HARRINGTON BABY	Retractors	VII	58
HARRINGTON-PEMBERTON	Retractors	VII	58
HARRIS	Wire pliers	XIV	29
HARTMANN	E.N.T. ear forceps	XII	31-32
	E.N.T. polypus forceps	XII	30
	E.N.T. punch forceps	XII	28
	E.N.T. specula	XII	16
	E.N.T. tuning forks	XII	59-60
	Intestinal and stomach clamp forceps	IV	68
	Retractors	VII	36
HARTMANN CITELLI	E.N.T. polypus forceps	XII	30
HARTMANN HALLE	E.N.T. specula	XII	18
HARTMANN WEINGARTNER	E.N.T. ear forceps	XII	31
HARVEY	Wire cutting scissors	III	31
HARVEY JACKSON	Retractors	VII	124
HAUTEFEUILLE	Retractors	VII	72
HEANEY	Needle holders	VI	10
	Retractors	VII	37
	Uterines curettes	VIII	75
	Uterines forceps	VIII	19
HEANEY-BALLENTINE	Uterines forceps	VIII	22
HEATH	Suture instruments	VI	7
HEGAR	Uterine dilators	VIII	82-84
HEGAR BAUMGARTNER	Needle holders	VI	11
HEGAR VASCULAR	Vascular needle holders	VI	22
HEGAR-OLSEN	Needle holders	VI	23
HEGAR-OLSEN-BABY	Needle holders	VI	23
HEGEMANN	Scissors for vascular surgery	III	34
HEGENBARTH	Suture instruments	VI	5
HEIFETZ	Spatulas	XI	5
HEISS	Long haemostatic forceps	IV	38
HEISS (HOLZEIMER)	Retractors	VII	111
HEISTER	E.N.T. mouth gag	XII	8
HELFERICH-BIER	Instruments for amputation	XIII	19
HENKE	E.N.T. elevator	XII	51
HENLEY	Retractors	VII	116
HENNING	Plaster forceps	XV	24
HERCULES	Wire cutting pliers	XIV	33-35
	Wire pliers	XIV	28
HERRICK	Instruments for bile ducts	IX	9
HERTZLER	Retractors	VII	108
HESS	Retractors	XI	8
HEY GROVES	Bone holding forceps	XIII	137
HEYMANN	ENT scissors	III	84
	Prestige scissors	III	79
HEYWOOD-SMITH	Haemorrhoidal forceps	VIII	94
	Uterines forceps	VIII	28
HIBBS	Bone chisels, ostéotomes, gouges	XIII	74
	Retractors	VII	37
HI-LEVEL KNOWLES	Incision scissors	III	28
HOEN	Raspatories and elevators	XIII	34
HOFFMAN	Miscellaneous forceps	IV	110
HOHMANN ALDINGER	Retractors	VII	137
HOLSHER	Retractors	XI	8
HOLZBACH	Uterines forceps	VIII	21
HONTON	Gouges	XIII	79
Hooks		XIII	24-59, 95
HORSLEY	Raspatories and elevators	XIII	36
HÖSEL	Retractors	VII	46
HOWARTH	Raspatories and elevators	XIII	27
HRYNTSCHAK	Retractors	VII	92
HUDSON	Bone drill	XI	10
HUMBY	Retractors, hooks	VII	9



		Chapter	Page
HUNTER	Splinters forceps	II	51
HURD	E.N.T. elevator	XII	51
IMA	Microsurgery fine forceps	X	17
	Incision scissors	III	28
	Instrument for flexible nails	XIV	43-46
	Instrumentation for knee	XIII	156-157
	Instrumentation for ligatures	XIII	150-155
	Instrumentation for services	XV	9-10, 15-20
	Instruments for amputation	XIII	15-21
	Instruments for autopsy	XIII	22-23
	Instruments for bending	XIV	20-22
	Instruments for bile ducts	IX	9-11
	Instruments for cannulated screw	XIV	47-49
	Instruments for cerclage	XIV	52
	Instruments for IM nails	XIV	40-41
	Instruments for kidney pedicle	IX	8
	Instruments for plates	XIV	17-18
	Instruments for prostate	VIII	95-96
	Instruments for RUSH nails	XIV	42
	Instruments for staples	XIV	50-51
	Instruments for urology	VIII	86
	Intestinal and stomach clamp forceps	IV	68-80
IOWA	Uterines forceps	VIII	10
ISRAEL	Retractors	VII	29
ISSELIN	Punches	XIII	91
IVG	Miscellaneous	VIII	81
J.L. FAURE	Biopsy forceps	VIII	62
	Special dissecting forceps	II	19
JACKSON	Retractors	VII	15
	Vaginal blades	VIII	44
JACOBS	Uterines forceps	VIII	10
JACOBSON	Curettes	XIII	53
	Microsurgery needle-holders	X	13
JACOBSON ADSON	Delicate dissecting forceps	II	23
JACOBSON HALSTEAD	Haemostatic forceps	IV	22
JACOBSON-ADSON	Ligature forceps, dissectors	IV	56
JAMESON	Long and fine scissors	III	46
	Needle holders	VI	12
	Prestige scissors	III	73
JANSEN	Bone rongeur forceps	XIII	105, 108
	Curettes	XIII	54
	ENT dissecting forceps	II	40
	Raspatories	XIII	41
	Retractors	VII	112
JANSEN (MIDDLETON)	E.N.T. punch forceps	XII	29
JANSEN-DEEP	Retractors	VII	112
JAVID	Atrauma vascular forceps	V	33
JAYLE	Vaginal blades	VIII	48
	Vaginal speculas	VIII	32
JENNINGS	E.N.T. mouth gag	XII	9
JESCO	Miscellaneous scissors	III	56
JL FAURE	Uterines forceps	VIII	15, 17
JOHNS HOPKINS	Bulldog clamps	V	9
JOLL	Retractors	VII	131
JONES	Towel forceps	IV	103
JOSEPH	E.N.T. Joseph's instruments	XII	52-53
	ENT scissors	III	83
	Prestige scissors	III	76
JOST	Raspatories and elevators	XIII	29
JUDD-ALLIS	Grasping forceps	IV	95
JUDD-MASSON	Retractors	VII	93
JUDET	Bone chisels, ostéotomes, gouges	XIII	75
	Mallets	XIII	90
	Retractors	VII	140
KADER	Retractors	VII	55
KANTROWITZ	Ligature forceps, dissectors	IV	61
KATZIN	Microsurgery scissors	X	7
KATZIN-BARRAQUER	Microsurgery scissors	X	7
KAYE	Prestige scissors	III	77
KAZANJIAN	Bone cutting forceps	XIII	117
KELLY	Anuscopes	VIII	89
	Haemostatic forceps	IV	31
	Long and fine scissors	III	48
	Prestige Haemostatic forceps	IV	116
	Retractors	VII	50, 55
	Tungsten scissors	III	57
	Uterines forceps	VIII	28
KELLY-RANKIN	Haemostatic forceps	IV	32
KERN	Bone holding forceps	XIII	135
KERRISSON	E.N.T. punch forceps	XII	27
KEVORKIAN	Biopsy forceps	VIII	66-67



		Chapter	Page
KEVORKIAN	Uterines curettes	VIII	77
KEY	Raspatories	XIII	41
KIELAND	Obstetrical forceps	VIII	55
KIENNY	Retractors	VII	19
KILLIAN	E.N.T. elevator	XII	50
	E.N.T. gouges	XII	40
KILNER	Delicate scissors	III	15
	E.N.T. hooks	XII	47
	Needle holders	VI	13
	Retractors, hooks	VII	10
KILNER (RAGNELL)	Tungsten scissors	III	57
KILNER-DOUGHTY	E.N.T. mouth gag	XII	11
KIRSCH	Retractors	VII	64
KIRSCHNER	Ligature instruments	VI	34
	Retractors	VII	83
	Traction bows	XIII	158-159
KIRSCHNER (AMERICAN)	Traction bows	XIII	160
KLAPP	Retractors	VII	20
KLEINERT-KUTZ	Retractors, hooks	VII	9
	Surgery for tendons	XIII	13
KLEINSCHMIDT	Intestinal and stomach clamp forceps	IV	77
KLINKENBERG	Miscellaneous scissors	III	50
	Tungsten scissors	III	67
KNAPP	E.N.T. hooks	XII	46
	Fine scissors	III	38
KNOWLES	Incision scissors	III	28
KOCHER	E.N.T. knives spatula	XII	25
	Haemostatic forceps	IV	9-11
	Haemostatic forceps	IV	10
	Haemostatic forceps	IV	11
	Instrumentation for services	XV	18
	Intestinal and stomach clamp forceps	IV	73-74
	Intestinal and stomach clamp forceps	IV	74
	Prestige Haemostatic forceps	IV	116
	Retractors	VII	26-27, 43-49
KOCHER-LANGENBECK	Retractors	VII	42
KOCHER-WAGNER	Retractors	VII	46
KOENING	Hooks	XIII	95
KOGAN	Endospeculas	VIII	36
KÖLBEL	Shoulder instrumentation	XIII	146
KÖNIG	Ligature instruments	VI	33
	Raspatories and elevators	XIII	35
	Retractors	VII	13
KÖRTE	Retractors	VII	28-29, 48
KÖRTE-WAGNER	Retractors	VII	28
KRAEMER	Raspatories	XIII	43
KRAMER	Raspatories	XIII	41
KRAUSE	E.N.T. snares	XII	21
	Trocars	XV	30
KRAUSE-VOSS	E.N.T. snares	XII	21
KRISTELLER	Vaginal blades	VIII	44
KRÖNLEIN	Haemostatic forceps	IV	17
KÜMMEL	Retractors	VII	48
LA GRANGE	Fine scissors	III	38
LA HEY (SWEET)	Ligature forceps, dissectors	IV	60
LABORDE	E.N.T. dilators	XII	12
LAGROT	Hand dermatome	I	9
LAHEY	E.N.T. grasping forceps	XII	14
	Retractors	VII	27
LAMBERT KAY	Atrauma vascular forceps	V	22
LAMBOTTE	Bone holding forceps	XIII	134
	Hooks	XIII	95
	Osteotomes	XIII	67
	Raspatories	XIII	49
	Retractors	VII	145
	Specific forceps	XIV	25
LAMBOTTE (PAUWELLS)	Osteotomes	XIII	66
LANDANGER	Bandage forceps	IV	122
	Biopsy forceps	VIII	64
	Bone holding forceps	XIII	128
	Instrumentation for meniscus	XIII	153
LANDAU	Trocars	XV	30
	Vaginal blades	VIII	43
LANDOLT	Miscellaneous scissors	III	45
	Scalpel handles, disposable blades	I	6
LANE	Intestinal and stomach clamp forceps	IV	79
	Retractors	VII	141
	Special dissecting forceps	II	13
LANE (KERN)	Bone holding forceps	XIII	135
LANE (PAUCHET)	Miscellaneous forceps	IV	109
LANE TRETOWAN	Retractors	VII	141



		Chapter	Page
LANGE	Plaster instruments	III	85
LANGE-HOHMANN	Retractors	VII	133-137
LANGENBECK	Bone holding forceps	XIII	139
	Instruments for amputation	XIII	16-17
	Needle holders	VI	26
	Raspatories	XIII	42, 47
	Raspatories and elevators	XIII	33
	Retractors	VII	44
LANGENBECK (LARREY)	Instruments for amputation	XIII	18
LANGENBECK-GREEN	Retractors	VII	17, 17
LARDENOIS	Retractors	VII	38-39
Laryngeal mirror		XV	8
LAWRENCE	Ligature forceps, dissectors	IV	60
LAZAR	Microsurgery fine forceps	X	16
LE MEE	E.N.T. specula	XII	16
	Tongue depressor	XV	7
LEBEAU	E.N.T. gouges	XII	40
	Raspatories and elevators	XIII	34
LEBSCHÉ	Costotomes	XIII	125
LECOUTEUR	Tongue depressor	XV	7
LEES	Atrauma vascular forceps	V	19
LEGUEU	Clamp forceps	IV	46
	Retractors	VII	60, 93
LEKSELL- STILLE	Bone rongeur forceps	XIII	112
LELIEVRE	E.N.T. chisels and gouges	XII	38
	Raspatories	XIII	48
LEMAIRE	Instrumentation for knee	XIII	156
LEMPERT	Bone rongeur forceps	XIII	106
	Curettes	XIII	61
	E.N.T. elevator	XII	51
LEPAGE	Uterines forceps	VIII	26
LERAT	Bone holding forceps	XIII	142
LERICHE	Blades	VII	57
	Haemostatic forceps	IV	25
	Instrumentation for services	XV	19
	Prestige Haemostatic forceps	IV	114
	Raspatories and elevators	XIII	33
	Retractors, hooks	VII	10
LERICHE-BUGATTI	Blades	VII	57
LERMOYER	E.N.T. adenoids knives	XII	23
LETOURNEL	Curettes	XIII	65
LEVRET	Obstetrical forceps	VIII	58
LEWIN	Bone holding forceps	XIII	142
LEWIS	E.N.T. rasps	XII	43
LEXER	Bone chisels, gouges	XIII	82
	Dissecting scissors	III	21
	Ostéotomes, gouges	XIII	81
LEXER-FINO	Dissecting scissors	III	21
	Tungsten scissors	III	60-61
LICHTENBERG	Needle holders	VI	26
LICHTWITZ	Trocars	XV	30
LIEGE	Grasping forceps	IV	99
Ligature cutting scissors		III	41-42
Ligature forceps, dissectors		IV	50-66
Ligature instruments		VI	33-34
Ligature needles		VI	28-32
LIMA	E.N.T. mallets and curettes	XII	54
LISTER	Bandage forceps	IV	126
	Bandage scissors	III	29
	Instrumentation for services	XV	15
	Tungsten scissors	III	66
LISTER-EXCENTRIC	Bandage scissors	III	30
LISTON	Bone cutting forceps	XIII	116, 119
	Costotomes	XIII	121
	Instruments for amputation	XIII	15
LISTON-KEY (HORSLEY)	Bone cutting forceps	XIII	120
LITTAUER	Ligature cutting scissors	III	42
LITTAUER-LISTON	Bone cutting forceps	XIII	117
LITTLER	Ligature cutting scissors	III	42
LITTLEWOOD	Grasping forceps	IV	99
LOCHARD	Miscellaneous forceps	IV	110
LOCKHART MUMMARY	Fluted directors	XV	13
LOCKLIN	Fine scissors	III	44
LOCKWOOD	Grasping forceps	IV	90
LOCKWOOD-ALLIS	Grasping forceps	IV	97
LOMBARD	Bone rongeur forceps	XIII	98
	Mallets	XIII	89
Long and fine scissors		III	46-49
Long haemostatic forceps		IV	37-43
LORENZ	Bandage scissors	III	29
LORNA	Towel forceps	IV	106



		Chapter	Page
LORTAT-JACOB	Miscellaneous materials	XV	32
LOUTE	Wire pliers	XIV	29
LOVE	Retractors	XI	6-7
LOVE (MORSE)	Retractors	VII	13
LOVE-ADSON	Raspatories	XIII	38
LOVELACE	Grasping forceps	IV	92
LOWE	Retractors	VII	14
LOWER	Ligature forceps, dissectors	IV	59
LOWMAN	Bone holding forceps	XIII	141
LOWMAN-HOGLUND	Bone holding forceps	XIII	141
LUBET BARBON	E.N.T. grasping forceps	XII	13
LUC	E.N.T. grasping forceps	XII	15
LUCAE	E.N.T. hooks	XII	45
	E.N.T. tuning forks	XII	60
	ENT dissecting forceps	II	40
	Mallets	XIII	87
LUCAE HARTMANN	E.N.T. tuning forks	XII	59
LUCAS	Bone chisels, gouges	XIII	68
	Bone chisels, ostéotomes, gouges	XIII	74
LUCAS-CHAMPIONNIERE	Trephine and drills	XIV	37
LUER	Bone rongeur forceps	XIII	103-104
	Retractors	VII	33
LUER KOERTE	Curettes for bile ducts	IX	13
LUER LOCK	Cannulas	XV	27
LUER-FRIEDMANN	Bone rongeur forceps	XIII	101
LUKENS	Retractors	VII	15
MAC EVEN	Bone chisels, ostéotomes, gouges	XIII	75
	Mallets	XIII	86
MAC INDOE	Bone cutting forceps	XIII	118
MAC KEE	Retractors	VII	117
MAGILL	Instrumentation for services	XV	9
MAINGOT	Uterines forceps	VIII	21
	Malleables splints	XV	25
	Mallets	XIII	85-90
MALTZ	E.N.T. rasps	XII	42
MANGIAGALLI	Vaginal blades	VIII	41
MARKHAM-MEYERDING	Retractors	VII	128
MARQUARDT	Bone rongeur forceps	XIII	110
MARTIN	Pelvimeters	VIII	78
	Retractors	VII	51
MARTIN (SIMPSON)	Uterine probes	VIII	85
MARTIN-CARTILAGE	Various scissors	III	37
MARTINI	Curettes	XIII	53
MASING	E.N.T. elevator	XII	50
MASING (NEIVERT)	Needle holders	VI	13
MASING (SILVER)	E.N.T. osteotomes	XII	39
MASSON	Needle holders	VI	12
MASSON	Needle holders	VI	17
MATHEY	Retractors	VII	110
MATHIEU	Needle holders	VI	12, 25
	Rectal speculas	VIII	87
	Retractors	VII	35
	Uterines polypus forceps	VIII	11
	Vaginal blades	VIII	46
MAURER	Costotomes	XIII	122
	Raspatories	XIII	50
	Retractors	VII	110, 146
MAYFIELD	Bone rongeur forceps	XIII	110
MAYO	Dissecting scissors	III	16
	Instrumentation for services	XV	16
	Miscellaneous materials	XV	32
	Prestige scissors	III	70
	Special dissecting forceps	II	17
	Tongue depressor	XV	6
	Tungsten scissors	III	59
MAYO BLAKE	Forceps gales stones	IX	7
MAYO ROBSON	Intestinal and stomach clamp forceps	IV	71
MAYO-ADAMS	Retractors	VII	81
MAYO-ALSACE	Dissecting scissors	III	18
MAYO-HARRINGTON	Dissecting scissors	III	19
MAYO-HEGAR	Instrumentation for services	XV	18
	Needle holders	VI	11, 16-18
MAYO-LEGER	Dissecting scissors	III	18
MAYO-LEXER	Prestige scissors	III	70
	Tungsten scissors	III	60-61
MAYO-LYON	Dissecting scissors	III	18
MAYO-NOBLE	Dissecting scissors	III	19
MAYO-SANTY	Dissecting scissors	III	19
MAYO-STILLE	Dissecting scissors	III	17
	Prestige scissors	III	70
	Tungsten scissors	III	60-61



	Chapter	Page	
MC DONALD	Raspatories and elevators	XIII	31
MC GIVNEY	Haemorrhoidal forceps	VIII	94
MC INDOE	Delicate dissecting forceps	II	31
	Dissecting forceps with tungsten jaws	II	47
Mc KENTY	E.N.T. elevator	XII	50
	Raspatories	XIII	39
MC LEAN	Obstetrical forceps	VIII	55
MC-INDOE	Various scissors	III	37
McKENZIE	Bone drill	XI	10
MEAD	Bone rongeur forceps	XIII	102
	Mallets	XIII	88
Measures		XIII	96
MEEKER	Ligature forceps, dissectors	IV	63
MERCEDES	Retractors	VII	105
MERIAM	Delicate dissecting forceps	II	29
MERLE D'AUBIGNÉ	Punches	XIII	92
	Raspatories	XIII	49
	Retractors	VII	139-140
	Shoulder instrumentation	XIII	148
MERLE D'AUBIGNÉ (BANKART)	Shoulder instrumentation	XIII	147
MERVEILLEUX	Prestige scissors	III	75
METZENBAUM	Dissecting scissors	III	22-23
	Instrumentation for services	XV	17
	Instruments for prostate	VIII	95
	Prestige scissors	III	71
	Tungsten scissors	III	62
METZENBAUM-FINO	Dissecting scissors	III	24
	Prestige scissors	III	71
	Tungsten scissors	III	63-65
MEYERDING	Retractors	VII	18, 49
MICHEL	Suture instruments	VI	5-7
MICHELE	Trephine and drills	XIV	37
MICHON	Clamp forceps	IV	46
MICRO	Fine scissors	III	38
MICRO ADSON	Delicate dissecting forceps	II	23
	Dissecting forceps with tungsten jaws	II	47
MICRO -HALSTEAD	Haemostatic forceps	IV	20
MICRO -MOSQUITO	Haemostatic forceps	IV	21
MICRO-RYDER	Vascular needle holders	VI	21
Microsurgery fine forceps		X	15-17
Microsurgery hooks		X	18-20
Microsurgery needle-holders		X	12-14
Microsurgery scissors		X	3-11
MIDDELDORPF	Retractors	VII	61-62
MIKULICZ	Retractors	VII	54
	Special haemostatic forceps	IV	48-49
MILLER	E.N.T. rasps	XII	44
MILLES	Microsurgery scissors	X	9
MILLIGAN	Raspatories and elevators	XIII	28
MILLIN	Instruments for prostate	VIII	95
	Retractors	VII	93
MILLS	Scissors for vascular surgery	III	35
MINI GEMINI	Ligature forceps, dissectors	IV	57
MINI LEXER	Ostéotomes, gouges	XIII	81
MINI TOWNSEND	Biopsy forceps	VIII	67
MINI-FRIEDMANN	Bone rongeur forceps	XIII	101
MINI-LANGENBECK	Retractors	VII	16
MIRIZZI	Forceps gales stones	IX	4-5
MITCHELL	Raspatories	XIII	42
MIXTER	Fine scissors	III	14
	Ligature forceps, dissectors	IV	58-59
MIXTER-O'SHAUGNESSY	Ligature forceps, dissectors	IV	58
MOHR	Miscellaneous forceps	IV	110
MOLT	Raspatories and elevators	XIII	27
MONOD	Trocars	XV	28
MONESTRUC	Retractors	VII	87
MOORE	Curettes for bile ducts	IX	13
	E.N.T. forceps and shear	XII	34
	Retractors	VII	145
MOORE LAMBOTTE			
MOREL FATIO	Raspatories and elevators	XIII	27
MORRIS	Retractors	VII	52
MORRIS DEBAKEY	Atrauma vascular forceps	V	24
MORSE-FAVALORO	Retractors	VII	105
MOSQUITO	Haemostatic forceps	IV	19
MOYNIHAN	Haemostatic forceps	IV	36
	Long haemostatic forceps	IV	43
MUHLING	Raspatories	XIII	40
MULLER	Phlebectomy	V	7
Multiservices forceps		XIV	27
MURPHY	Instrumentation for knee	XIII	156
	Instrumentation for services	XV	20



		Chapter	Page
MURPHY	Retractors	VII	23
	Tubing forceps	IV	112
MUSEUX	Bone holding forceps	XIII	142
	Uterines forceps	VIII	7-8
MUSEUX PALMER	Uterines forceps	VIII	9
MUSEUX PALMER-CHERON	Uterines forceps	VIII	9
MYERS	Strippers	V	5
MYRTLE	Fluted directors	XV	13
NABATOFF	Strippers	V	5
NAGELE	Obstetrical forceps	VIII	56
Nails scissors		III	88
NANCY	Gouges	XIII	78
	Various scissors	III	27
Narrow dissecting forceps		II	8
Needle holders		VI	8-26
NEFF	Instrumentation for meniscus	XIII	151
NEGUS	Intestinal and stomach clamp forceps	IV	69
NEIVERT	Needle holders	VI	14
NELATON	Fluted directors	XV	13
	One-piece scalpels	I	2
	Trephine and drills	XIV	37
NELSON	Trocars	XV	29
Neonatal and pediatric clamps		V	37-39
NEW ORLEANS	Needle holders	VI	17
NEW SUTURE	Incision scissors	III	28
NICOLLET-KOCHER	Instrumentation for meniscus	XIII	153
NICOLLET-MUSEUX	Instrumentation for meniscus	XIII	153
NISSEN	Haemostatic forceps	IV	35
	Instruments for bile ducts	IX	11
NORFOLK-NORWICH	Retractors	VII	117
NORTHFIELD	Bone rongeur forceps	XIII	107
NOTO	Uterines forceps	VIII	28
NOTTER	Miscellaneous	VIII	60
NOVAC	Miscellaneous	VIII	80
NOYES	Microsurgery scissors	X	6
NUBOER	Suction tubes	XV	26
NUSSBAUM	Intestinal and stomach clamp forceps	IV	78
Obstetric vacuum cup		VIII	61
Obstetrical forceps		VIII	53
		VIII	54-59
OBWEGESER	Osteotomes	XIII	67
	Retractors	VII	63, 65
OCHSNER	Atrauma vascular forceps	V	17
OEHLER	Dissecting forceps with tungsten jaws	II	45
OLIVECRONA	Bone rongeur forceps	XIII	106
	Instruments for amputation	XIII	20
	Raspatories and elevators	XIII	26
	Spatulas	XI	4
OLIVIER	Retractors	VII	82
OLLIER	Bone holding forceps	XIII	136, 140
	Instrumentation for knee	XIII	157
	Raspatories and elevators	XIII	44
	Retractors	VII	30
OMBREDANNE	Bone chisels, gouges	XIII	70
	Grasping forceps	IV	98
	Mallets	XIII	85
	Punches	XIII	91
One-piece scalpels		I	2
OPEN COELIO	Retractors	VII	33
Ophthalmologic dissecting forceps		II	36
OSCHNER	Delicate dissecting forceps	II	33
O'SHAUGNESSY	Instruments for prostate	VIII	95
	Ligature forceps, dissectors	IV	51-53
Osseous chisel		XIV	24
Osteotomes		XIII	66-67
Ostéotomes, gouges		XIII	81
O'SULIVAN - O'CONNOR	Retractors	VII	85
OUPET	Clamp forceps	IV	47
OVERHOLT -GEISSENDORFER	Ligature forceps, dissectors	IV	54
OVERHOLT -S	Ligature forceps, dissectors	IV	55
OVERHOLT -SLIM	Ligature forceps, dissectors	IV	55
OVERHOLT-MIXTER	Ligature forceps, dissectors	IV	61
PAJOT	Obstetrical forceps	VIII	55
PALMER	Retractors	VII	78
	Uterine dilators	VIII	82
	Uterines polypus forceps	VIII	11
PARKER	Retractors	VII	35
PARKER LANGENBECK (US ARMY)	Retractors	VII	35
PARKER-MOTT	Retractors	VII	36
PARTSCH	Bone chisels, gouges	XIII	68
	Mallets	XIII	85



		Chapter	Page
PARTSCH (HAUTANT)	E.N.T. chisels and gouges	XII	38
PASSOW	Grafts pusher	XIII	144
PATTERSON	Biopsy forceps	VIII	66
PAUCHET	Suture instruments	VI	5
PAUCHET (SABRE)	Ligature needles	VI	29
PAYR	Intestinal and stomach clamp forceps	IV	75
	Ligature instruments	VI	34
PAYR (BABY)	Intestinal and stomach clamp forceps	IV	75
PEAN	Bandage forceps	IV	118
	Instrumentation for services	XV	17
	Trocars	XV	30
PEDERSON	Vaginal speculas	VIII	35
PEERS	Towel forceps	IV	105
PEET	Splinters forceps	II	52
PELKMANN	Bandage forceps	IV	127
	Pelvimeters	VIII	78
PENFIELD	Raspatories and elevators	XIII	30
PENNINGTON	E.N.T. raspatories	XII	41
	Grasping forceps	IV	89
PENNYBACKER	Bone rongeur forceps	XIII	107
	Raspatories	XIII	42
	Percussion hammers, Stethoscope	XV	5
PERCY	Instruments for amputation	XIII	21
PERRY	Delicate dissecting forceps	II	37
PERTHES	Punches	XIII	93
PETIT DUTAILLY	Raspatories and elevators	XIII	37
PHANEUF	Uterines forceps	VIII	22
Phlebectomy		V	7-8
PINARD	Percussion hammers, Stethoscope	XV	5
	Pincés à dissection moyennes	II	7
PIPER	Obstetrical forceps	VIII	58
PIRON	Uterines curettes	VIII	75
	Plaster forceps	XV	23-24
	Plaster instruments	III	85
	Plaster scissors	XV	22
PLESTER	E.N.T. suction tubes	XII	57
	Retractors	VII	113
POIRIER	Bone chisels, gouges	XIII	70
POLITZER	ENT dissecting forceps	II	39
POLOSSON	Retractors	VII	56
POOLE	Suction tubes	XV	26
POSTEL	Instruments for amputation	XIII	18
	Retractors	VII	146
POTTS DE MARTEL	Scissors for vascular surgery	III	35
POTTS-SMITH	Delicate dissecting forceps	II	26
	Dissecting forceps with tungsten jaws	II	46
	Prestige scissors	III	74
	Scissors for vascular surgery	III	32, 36
	Tungsten scissors	III	69
	Various scissors	III	37
POZZI	Shoulder instrumentation	XIII	148
	Uterines curettes	VIII	76
	Uterines forceps	VIII	12
POZZI CHERON	Miscellaneous	VIII	80
POZZI PALMER	Uterines forceps	VIII	12
PRATT	Grasping forceps	IV	102
	Rectal speculas	VIII	87
	Uterine dilators	VIII	84
	Uterines forceps	VIII	25
PRECELLE	Delicate dissecting forceps	II	37
	Prestige dissecting forceps	II	48-50
	Prestige Haemostatic forceps	IV	113-117
	Prestige scissors	III	70-79
PRICE THOMAS	Grasping forceps	IV	81
PRINCE	Various scissors	III	37
	Probes	XV	12
	Probes and Spatulas	V	6
PROVIDENCE	Haemostatic forceps	IV	26
	Punches	XIII	91-93
	Punches and trephines	XIII	94
	Punches forceps	XI	16-23
PUTTI	Rasps	XIII	84
QUENU	Intestinal and stomach clamp forceps	IV	68
	Special dissecting forceps	II	20
QUILICY FAR ISSE	Ligature forceps, dissectors	IV	62
QUINBY	Miscellaneous scissors	III	45
QUIRE	E.N.T. ear forceps	XII	32
RACHIS NOGENT	Retractors	VII	106
RAGNEL (DAVIS)	Retractors	VII	19
RALK	Bone hand drills	XIV	9
RAMPLEY	Bandage forceps	IV	123



		Chapter	Page
RAMUS	Retractors	VII	65
RANDALL	Forceps for kidney stones	IX	3
Raspatories		XIII	38-51
Raspatories and elevators		XIII	26-37, 44-45
Rasps		XIII	84
Reamers and gauges		XIV	10
RECAMIER	Uterines curettes	VIII	74
Rectal biopsy forceps		VIII	92
Rectal retractors		VIII	90-91
Rectal speculas		VIII	87-88
REDON	Ligature forceps, dissectors	IV	50
	Ligature needles	VI	30
RESANO	Ligature forceps, dissectors	IV	67
Retractor, lead hands		XIII	143
Retractors		VII	11-146
		XI	6-8
Retractors malleable blades		VII	41
Retractors, hooks		VII	9-10
REVERDIN	Suture needles	VI	27
REVERDIN (PAUCHET)	Retractors	VII	39
REVERSIBLE	Retractors	VII	101
REYNOLDS	Long and fine scissors	III	46
	Prestige scissors	III	73
RICARD	Retractors	VII	73, 75
RICARD-BEGOIN	Retractors	VII	74
RICHARDSON	Retractors	VII	50
RICHARDSON-EASTMAN	Retractors	VII	50
RICHTER	Incision scissors	III	28
Rigid medulary reamers		XIV	38
RIZZUTI	Raspatories and elevators	XIII	26
ROBB	Raspatories and elevators	XIII	29
ROBERTS	Long haemostatic forceps	IV	41
ROBIN	E.N.T. chisels and gouges	XII	37
ROCHARD	Retractors	VII	67-68
	Uterines forceps	VIII	26
ROCHER	Punches and trephines	XIII	94
ROCHESTER-CARMALT	Special haemostatic forceps	IV	14
ROCHESTER-OSCHNER	Haemostatic forceps	IV	13
ROCHESTER-PEAN	Haemostatic forceps	IV	12
ROEDER	Towel forceps	IV	107
ROGERS	Uterines forceps	VIII	18
ROLLET	E.N.T. hooks	XII	46
Rongeurs Forceps		XI	11-15
ROSE	Retractors	VII	15
RÖTTGEN-RUSKIN	Bone rongeur forceps	XIII	112
ROUENNAIS	Miscellaneous scissors	III	55
ROUX	Raspatories	XIII	47
	Retractors	VII	34
ROWE	E.N.T. reposition forceps	XII	35
RUALT	E.N.T. knives spatula	XII	25
RUBIN	E.N.T. forceps and shear	XII	34
RUMEL	Ligature forceps, dissectors	IV	63
RUMEL BELMONT	Phlebectomy	V	7
RUSKIN	Bone rongeur forceps	XIII	110
RUSKIN-LISTON	Bone cutting forceps	XIII	118
RUSSIAN MODEL	Special dissecting forceps	II	17
RYDER	Vascular needle holders	VI	21
SACHS	Raspatories and elevators	XIII	36
SAENGER	Uterines forceps	VIII	30
SANTORINI	Instruments for prostate	VIII	95
SANTULLI	Bulldog clamps	V	10
SANTY	Long haemostatic forceps	IV	42
	Suction tubes	XV	26
SANVENERO	Long and fine scissors	III	49
SAROT	Long haemostatic forceps	IV	41
	Vascular needle holders	VI	22
SATINSKY	Atrauma vascular forceps	V	22
	Grasping forceps	IV	82
	Miscellaneous scissors	III	50
SATTERLEE	Instruments for amputation	XIII	18
SAUERBRUCH	Bone rongeur forceps	XIII	114
	Costotomes	XIII	124
	Retractors	VII	51, 53
SAUERBRUCH-FREY	Costotomes	XIII	124
Saw to cut the ring		XV	11
Scalpel handles, disposable blades		I	3-6
SCHADEL	Towel forceps	IV	103
SCHUDE	Curettes	XIII	57
SCHIEBE	Intestinal and stomach clamp forceps	IV	70
SCHERBAK	Vaginal speculas	VIII	50
SCHINK	Hand dermatome	I	8



		Chapter	Page
SCHMID	Probes and Spatulas	V	6
SCHNIDT	Ligature forceps, dissectors	IV	56
SCHOEMAKER-LOTH	Wire cutting scissors	III	31
SCHRÖDER	Uterines curettes	VIII	72
SCHROEDER	Uterines forceps	VIII	13-14
SCHULTZE	Miscellaneous	VIII	79
SCHUMACHER	Biopsy forceps	VIII	63
	Retractors	VII	138
	Scissors for umbilical cord	III	80
SCHUMACHER (WAGNER)	Retractors	VII	138
SCHUMAKER	Biopsy forceps	VIII	65
	Scissors for deep operation	III	51-52
	Scissors for umbilical cord	III	80
	Scissors for vascular surgery	III	32-36
SCOVILLE	Curettes	XIII	63
	Screw driver	XIV	11-13
SCUDDER	Intestinal and stomach clamp forceps	IV	78
SEBILEAU	E.N.T. mallets and curettes	XII	54
	E.N.T. raspatories	XII	41
	Raspatories and elevators	XIII	34
	Raspatories	XIII	43
SEDILLLOT	Retractors	VII	55
SEGOND	Uterines forceps	VIII	19
SEGOND-LANDAU	Uterines forceps	VIII	19
SEGURA	E.N.T. mallets and curettes	XII	54
SELLORS	Retractors	VII	109
SEMB	Bone cutting forceps	XIII	120
	Bone holding forceps	XIII	138
	Bone rongeur forceps	XIII	115
	Ligature forceps, dissectors	IV	64
	Raspatories	XIII	47
SEMB-SAYLOR	Ligature forceps, dissectors	IV	64
SEMKEN	Delicate dissecting forceps	II	32
	Dissecting forceps with tungsten jaws	II	47
SEMM	Retractors	VII	85
	Vaginal speculas	VIII	35
SENN GREEN (CHIGOT)	Retractors	VII	16
SENN-MILLER	Retractors	VII	19
SENN-MILLER BABY	Retractors	VII	19
SETTER	Bone holding forceps	XIII	137
SEUTIN	Miscellaneous forceps	XV	21
	Plaster scissors	XV	22
SEWALL	Raspatories and elevators	XIII	36
SEYFFERT	Vaginal speculas	VIII	35
	Shoulder instrumentation	XIII	146-149
SHUBERT	Biopsy forceps	VIII	62
SICARD	Bone rongeur forceps	XIII	99
SICART	Raspatories and elevators	XIII	37
SIEBOLD	Miscellaneous scissors	III	50
SIMON	Retractors	VII	51
	Uterines curettes	VIII	70, 72
SIMPSON	Obstetrical forceps	VIII	57
SIMPSON BRAUN	Obstetrical forceps	VIII	58
SIMPSON LU IKART	Obstetrical forceps	VIII	59
SIMS	One-piece scalpels	I	2
	Prestige scissors	III	76
	Rectal speculas	VIII	88
	Scissors for deep operation	III	52
	Tungsten scissors	III	68
	Uterine probes	VIII	85
	Uterines curettes	VIII	73
	Vaginal blades	VIII	45
SIMS-MAIER	Bandage forceps	IV	127
SINGLEY TUTTLE	Special dissecting forceps	II	21
SISTERON	Forceps gales stones	IX	6
SKID MURPHY	Retractors	VII	145
SLUDDER-BALLENGER	E.N.T. tonsillotome	XII	26
SMILLIE-TRILLAT	Instrumentation for meniscus	XIII	151-152
SMITH	Various scissors	III	87
SMITH PETERSEN	Gouges	XIII	78
SMITH-PETERSEN	Bone chisels, ostéotomes, gouges	XIII	71-72
	Bone rongeur forceps	XIII	112
SNELLEN	E.N.T. curettes	XII	55
SOMMER	Uterine elevating forceps	VIII	52
	Spatulas	XI	3-5
	Special dissecting forceps	II	12-21, 34-35
	Special haemostatic forceps	IV	14, 44-49
	Specific forceps	XIV	25-26
SPENCER	Ligature cutting scissors	III	41
SPENCER WELLS	Haemostatic forceps	IV	15, 18
SPENCER-FINO	Ligature cutting scissors	III	42



		Chapter	Page
SPINA-NASALIS	Retractors	VII	65
Splinters forceps		II	51-52
ST MARKS	Vaginal blades	VIII	47
STAGNARA	Gouges	XIII	80
STAMEY	Ligature needles	VI	29
STANDARD	Trocars	XV	29
Standard dissecting forceps		II	5-6
STEINMANN	Surgery for tendons	XIII	13-14
STELLBRINK	Bone rongeur forceps	XIII	105
STERNAL	Retractors	VII	101
STERNBERG	E.N.T. mouth gag	XII	8
STEVENS	Fine scissors	III	43
	Prestige scissors	III	73
STEVENS (RIBBON TYPE)	Fine scissors	III	43
STIEGLITZ	Splinters forceps	II	52
STILLE	Bone chisels, ostéotomes, gouges	XIII	73
	Bone rongeur forceps	XIII	111
	Delicate dissecting forceps	II	15
	Instruments for bile ducts	IX	9
	Plaster forceps	XV	23
STILLE-LUER	Bone rongeur forceps	XIII	115
STOOKEY	Bone rongeur forceps	XIII	108
STRANDELL-STILLE	Retractors	VII	17
STRASBOURG	Special dissecting forceps	II	13
STRATT	Needle holders	VI	19
STRAUSS	Instruments for urology	VIII	86
STRELI	Needle holders	VI	9
Strippers		V	5
STRUCK	Retractors	VII	104
STRULLY	Long and fine scissors	III	48
STRUYCKEN	E.N.T. punch forceps	XII	28
SUBRAMANIAN	Atrauma vascular forceps	V	31
Suction tubes		XV	26
Surgery for tendons		XIII	11-14
Surgical scissors		III	9-11
Suture instruments		VI	5-7
Suture needles		VI	27
SYME	Raspatories and elevators	XIII	29
TAKAHASHI	E.N.T. punch forceps	XII	28
TAKAHASHI	E.N.T. rasps	XII	42
Taps		XIV	6
TARNIER	Obstetrical forceps	VIII	53
TAYLOR	Delicate dissecting forceps	II	27
	Retractors	XI	7
TEALE	Uterines forceps	VIII	10
TEISSIER	Obstetrical forceps	VIII	59
TENOTOME	One-piece scalpels	I	2
TERRIER	E.N.T. mouth gag	XII	7
	Haemostatic forceps	IV	15-16
TESSIER	Retractors	VII	66, 110
THERUM	Miscellaneous	VIII	81
THOMS-ALLIS	Grasping forceps	IV	97
THUDICHUM (GOLDSMITH)	E.N.T. specula	XII	17
TIECK	E.N.T. specula	XII	19
TISCHLER	Biopsy forceps	VIII	67
TISCHLER-MORGAN	Biopsy forceps	VIII	64
TOENNIS	Long and fine scissors	III	47
	Raspatories and elevators	XIII	31
TOENNIS-ADSON	Long and fine scissors	III	47
	Tungsten scissors	III	65
TOENNIS-ADSON-FINO	Long and fine scissors	III	47
TOHOKU	Towel forceps	IV	106
Tongue depressor		XV	6-7
TOUPET	Retractors	VII	72, 76
TOUPET (ENTEROSTAT)	Retractors	VII	76
Towel forceps		IV	103-107
TOWNSEND	Biopsy forceps	VIII	67
Traction bows		XIII	158-161
TRAVERS	Retractors	VII	115
TRELAT	Rectal speculas	VIII	87
Trepine and drills		XIV	37
TREVES	Special dissecting forceps	II	12
TRILLAT	Grafts pusher	XIII	144
	Instrumentation for knee	XIII	156
	Instrumentation for meniscus	XIII	155
	Retractors	VII	143
	Shoulder instrumentation	XIII	149
Trocars		XV	28-30
TROELTSCH	ENT dissecting forceps	II	38
TROUSSEAU	E.N.T. dilators	XII	12
TROUTMAN	Microsurgery scissors	X	7



		Chapter	Page
TROUTMAN-BARRAQUER	Microsurgery scissors	X	5
TUBBS	Vascular dilators	V	40
TUBIANA	Needle holders	VI	9
Tubing forceps		IV	111-112
TUFFIER	Grasping forceps	IV	98
	Retractors	VII	38, 49
TULIPE	Phlebectomy	V	7
Tungsten scissors		III	57-69
UCKERMANN	E.N.T. dilators	XII	12
UFFENORDE	Curettes	XIII	58
ULRICH	Bandage forceps	IV	121
	Bone holding forceps	XIII	131
UNIVERSAL	Trocars	XV	29
Universal chucks		XIV	8
UNIVERSEL	Wire cutting scissors	III	31
UNNA	Curettes	XIII	53
USA MODEL	Plaster forceps	XV	23
Uterine dilators		VIII	82-84
Uterine elevating forceps		VIII	52
Uterine probes		VIII	85
Uterines curettes		VIII	68-77
Uterines forceps		VIII	7-30
Uterines polypus forceps		VIII	11
VACHER	E.N.T. snares	XII	20
	E.N.T. specula	XII	16
Vaginal blades		VIII	37-49
Vaginal speculas		VIII	31-35, 50
VALLEIX	Uterine probes	VIII	85
VAN DOREN	Biopsy forceps	VIII	63
VANNAS	Microsurgery scissors	X	4, 9-10
VARADY	Phlebectomy	V	8
Vascular dilators		V	40
Vascular dissecting forceps		II	41-43
Vascular needle holders		VI	20-22
Vasectomy forceps		VIII	93
VELPEAU (TRICOISE)	Costotomes	XIII	125
VERBRUGGE	Bone holding forceps	XIII	127-130
VERBRUGGE-MULLER	Retractors	VII	136
VERNON	Percussion hammers, Stethoscope	XV	5
Very fine dissecting forceps		II	11
VIDAL	Curettes	XIII	52
VINCENT	Bone rongeur forceps	XIII	99
	Prestige dissecting forceps	II	49
	Scissors for vascular surgery	III	36
	Instruments for amputation	XIII	15, 17
VIRCHOW			
WISE	Delicate dissecting forceps	II	33
VK Retractors		VII	71
VOLKMANN	Curettes	XIII	54-57
	Retractors	VII	22-25
	Uterines curettes	VIII	71
WACHENFELDT	Suture instruments	VI	5
WAGENER	E.N.T. hooks	XII	45
WAGNER	Fine scissors	III	14
	Prestige scissors	III	72
	Raspatories	XIII	51
	Retractors	VII	133
WALDMANN	Episiotomy scissors	III	82
WALLICH	Uterines curettes	VIII	69
WALSHAM	E.N.T. reposition forceps	XII	35
WALTER -DUVAL	Grasping forceps	IV	86
WALTER-CARMALT	Splinters forceps	II	51
WALTON	Fine scissors	III	40
	Retractors	VII	127
WANGENSTEEN	Dissecting forceps with tungsten jaws	II	45
	Needle holders	VI	17
WATSON CHEYNE	Probes	XV	12
	Raspatories and elevators	XIII	31
WAUGH	Delicate dissecting forceps	II	31
WEBSTER	Needle holders	VI	8
WECKER	Microsurgery scissors	X	6
WEIL-BLAKESLEY	Rongeurs Forceps	XI	15
WEISS	Tubing forceps	IV	111
WEITLANER	Retractors	VII	114-115
WEITLANER (MOLLISON)	Retractors	VII	118
WEITLANER-NEURO	Retractors	VII	119
WEITLANER-WULLSTEIN	Retractors	VII	118
WERTHEIM	Scissors for deep operation	III	52
	Uterines forceps	VIII	16, 20
WERTHEIM (BOZEMANN)	Needle holders	VI	19
WERTHEIM CULLEN	Uterines forceps	VIII	23
WERTHEIMER	E.N.T. suction tubes	XII	57



		Chapter	Page
WESTCOTT	Microsurgery scissors	X	3, 7
WHITE	E.N.T. grasping forceps	XII	13
WHITEHEAD	E.N.T. mouth gag	XII	9
WICKSTROEM	Ligature forceps, dissectors	IV	59
WIEN	E.N.T. specula	XII	19
WILLIAMS	Retractors	VII	129
WILLIGER	Curettes	XIII	53
	E.N.T. curettes	XII	56
	Raspatories and elevators	XIII	35
WILMER	Fine scissors	III	39
WINTER	Uterines forceps	VIII	29
Wire cutting pliers		XIV	30-36
Wire cutting scissors		III	31
Wire pliers		XIV	28-29
WOLF	Plaster forceps	XV	23
WOODSON	Raspatories and elevators	XIII	28
WRIGLEY	Obstetrical forceps	VIII	57
WYLIE	Atrauma vascular forceps	V	16
YANKAUER	Raspatories and elevators	XIII	34
	Suction tubes	XV	26
YASARGIL	Microsurgery needle-holders	X	13
	Microsurgery scissors	X	11
	Raspatories and elevators	XIII	31
YEOMAN	Rectal biopsy forceps	VIII	92
YOUNG	Instrumentation for services	XV	9
	Instruments for prostate	VIII	96
ZENKER	Ligature forceps, dissectors	IV	60
	Retractors	VII	48
ZIELKE	Gouges	XIII	83
ZWEIFEL	Needle holders	VI	26



		Capítulo	Página
AACHEN	Espátulas	XI	5
ABADIE	Separadores	VII	91
ABOULKER	O.R.L. dilatadores	XII	12
	Pinzas gubias	XIII	100
	Raspadores y elevadores	XIII	32
	Separadores	VII	11
ABRAHAM	O.R.L. bistouris espátulas	XII	25
ADLERKREUTZ	Pinzas para disección especiales	II	16
	Pinzas para disección Prestige	II	50
ADSON	Ganchos	XIII	24
	Instrumentación de servicio	XV	17
	Pinzas gubias	XIII	104
	Pinzas hemostáticas	IV	35
	Pinzas para disección boca de tungsteno	II	47
	Pinzas para disección delicadas	II	22
	Porta agujas	VI	10
	Raspadores	XIII	38
	Separadores	VII	124, 126
ADSON ATRAUMA	Pinzas para disección delicadas	II	24
ADSON BIMER	Pinzas para disección delicadas	II	24
ADSON BROWN	Pinzas para disección delicadas	II	22
ADSON GRAEFE	Pinzas para disección delicadas	II	24
	Agujas de sutura	VI	27
	Agujas para ligaduras	VI	28-32
ALAN PARKS	Separadores rectales	VIII	91
ALEXANDER	Osea cincelas, osteotomos, gubias	XIII	71
	Raspadores y elevadores	XIII	29
	Alicates para cortar alambre	XIV	30-36
ALLAINE	Disecadores	IV	53
	Tijeras para disección	III	25-26
ALLAIRE	Tijeras delicadas	III	15
ALLEN	Pinzas clamps intestinales y estomacales	IV	77
ALLIS	Pinzas a presión	IV	94
ALLIS-ADAIR	Pinzas a presión	IV	96
ALLISON	Separadores	VII	40
ALM	Separadores	VII	111
	Amnioscopo	VIII	51
	Amplificador para injerto de piel	I	10
ANDERSON-ADSON	Separadores	VII	119
ANDREW PYNCHON	Cánulas aspirantes	XV	26
	Anuscopios	VIII	89
ARNOUS	Separadores	VII	55
ARRUGA	Microcirugía pinzas finas	X	16
ASCH	O.R.L. pinzas y cizalla	XII	34
AUBERT (FINSTERER)	Cánulas aspirantes	XV	26
AUBRY (EN Z)	O.R.L. separadores	XII	48
AUFRICHT	O.R.L. raspas	XII	43
	O.R.L. separadores y ganchos	XII	49
AUSTIN	Pinzas para disección delicadas	II	33
AUVARD	Valvas vaginales	VIII	49
AUVERT	Pinzas a presión	IV	92
	Separadores	VII	86
BABCOCK	Pinzas a presión	IV	100-101
BABCOCK (BABY)	Pinzas a presión	IV	100
BABINSKY	Martillos a reflejos, Estetoscopio	XV	5
BABY CRILE-WOOD	Porta agujas	VI	15
BABY METZENBAUM	Tijeras Prestige	III	71
BABY POOLE	Cánulas aspirantes	XV	26
BABY SATINSKY	Pinzas a presión	IV	82
BABY-ADSON	Disecadores	IV	50
BABY-ALLIS	Pinzas a presión	IV	95
BABY-COLLIN	Separadores	VII	81
BABY-CRILE	Pinzas hemostáticas	IV	30
BABY-DOYEN	Pinzas clamps intestinales y estomacales	IV	70
BABY-HAIGHT	Separadores	VII	98
BABY-KOCHER	Pinzas clamps intestinales y estomacales	IV	70
BABY-LEXER	Tijeras para disección	III	21
BABY-MIXTER	Disecadores	IV	58
BABY-OVERHOLT	Disecadores	IV	58
BABY-ROUX	Separadores	VII	34
BABY-TISCHLER (MINI-TO WNSEND)	Pinzas para biopsia	VIII	64
BACKHAUS	Instrumentación de servicio	XV	20
	Pinzas de campo	IV	104-105
BACON	Pinzas gubias	XIII	108
BAILEY	Separadores	VII	109
BAILEY-BABY	Separadores	VII	109
BAINBRIDGE	Pinzas clamps vasculares atrauma	V	14
	Pinzas hemostáticas especiales	IV	44
BAKES	Dilatadores para vías biliares	IX	14
BALFOUR	Separadores	VII	89-90
BALFOUR (USA-MODEL)	Separadores	VII	91



		Capítulo	Página
BALLENGER	O.R.L. cuchillos para vegetaciones	XII	24
	O.R.L. gubias	XII	40
BALLENTINE	Pinzas uterinas	VIII	22
BANE HARTMANN	Pinzas gubias	XIII	105
BANKART	Instrumentación para hombro	XIII	148
BAR	Diverso	VIII	60
BARR	Separadores rectales	VIII	90
BARRAQUER	Microcirugía porta-agujas	X	14
BARRAYA	Disecadores	IV	65
	Pinzas para disección delicadas	II	14
	Pinzas para disección Prestige	II	50
BARRE	Instrumentos para vías biliares	IX	11
BARSKY	Separadores, ganchos	VII	9
BARTH	Curetas	XIII	54
BECK	Pinzas clamps vasculares atrauma	V	23, 34
BECKMANN	O.R.L. cuchillos para vegetaciones	XII	23
	Separadores	VII	120-122
BECKMANN (MOORE)	O.R.L. cuchillos para vegetaciones	XII	24
BECKMANN CONE	Separadores	VII	120
BECKMANN-ADSON	Separadores	VII	125
BECKMANN-EATON	Separadores	VII	124
BECKMANN-GOITER	Separadores	VII	121
BECKMANN-STILLE	Separadores	VII	121
BEEBE	Tijeras para cortar hilos	III	31
BELLUCI	O.R.L. micro instrumentos	XII	33
BENGOLEA	Pinzas hemostáticas largas	IV	39-40
	Pinzas hemostáticas Prestige	IV	115
BENNET	Separadores	VII	143
BENSAUDE	Anuscopios	VIII	89
BENSON	Pinzas a presión	IV	102
BERGER	Pinzas para biopsia	VIII	65
BERGERET TOUPET	Separadores	VII	72
BERGMANN	Martillos	XIII	87
	Separadores, ganchos	VII	10
	Tijeras para vendajes	III	30
BERNHARD	Pinzas de campo	IV	105
BESNIER	Curetas	XIII	52
BETHUNE	Costotomos	XIII	122
BEYER	Pinzas gubias	XIII	106, 109
BEYER-ZAUFAL	Pinzas gubias	XIII	109
BILLEAU	O.R.L. mazos y curetas	XII	56
BIRCHER	Instrumentación para menisco	XIII	151
BIRCHER-GANSKE	Instrumentación para menisco	XIII	154
BIRKETT	Pinzas hemostáticas	IV	34
	Bisturís disponibles estériles	I	7
	Bisturís fijos	I	2
BLAKE	Curetas uterinas	VIII	76
	Pinzas para calculos biliares	IX	7
BLONDIAU	O.R.L. mazos y curetas	XII	54
BLOUNT	Instrumentación para menisco	XIII	152
	Separadores	VII	142
BLUMENTHAL	Pinzas gubias	XIII	102
BOEHLER	Estribos de tracción	XIII	161
	Pinzas cortantes	XIII	118
	Pinzas gubias	XIII	109
BOETTCHER	Tijeras diversas	III	37
BONN	Tijeras finas	III	39
BONNAIRE	Pinzas uterinas	VIII	27
BONNEY	Pinzas para disección especiales	II	12
BONNIOT	Pinzas hemostáticas	IV	24
BORDIER-MEUNIER	Trocares	XV	28
BOSE	O.R.L. espéculos	XII	17
BOURGEOIS	O.R.L. pinzas a presión	XII	14
BOWMAN (PALMER)	O.R.L. espéculos	XII	17
BOYS-ALLIS	Pinzas a presión	IV	96
BOZEMANN	Pinzas para vendajes	IV	125
BRAND	Cirugía para tendones	XIII	11, 14
BRAUN	Diverso	VIII	79
	Pinzas uterinas	VIII	25
BRAUN-STADLER	Tijeras episiotomía	III	81
BREISKY	Pelvimetros	VIII	78
	Valvas vaginales	VIII	43
BRIDGE	Pinzas hemostáticas largas	IV	37
BRISTOW	Separadores	VII	141
Brocas		XIV	5
	Brocas rígidas para la medula	XIV	38
BROCK	Curetas	XIII	52
BROPHY	Pinzas para disección delicadas	II	28
	Tijeras largas y finas	III	49
BROWN RESANO	Pinzas para disección especiales	II	18
BRUENINGS	Depresor lingual	XV	6



		Capítulo	Página
BRUENINGS	O.R.L. cierra nudos	XII	20
BRUNETTI	Instrumentos para autopsia	XIII	23
BRUNNER	Agujas para ligaduras	VI	31
	Costotomos	XIII	123
	Pinzas clamps intestinales y estomacales	IV	76
	Separadores	VII	45
BRUNS	Curetas	XIII	58,62
	Instrumentos para escayolas	III	85
	Tijeras para escayolas	XV	22
BRYANT	Pinzas para vendajes	IV	126
BUCK	O.R.L. mazos y curetas	XII	55
	O.R.L. pinzas para orejas	XII	32
BUCK-GRAMCKO	Separadores	VII	132
BUELAU	Trocares	XV	30
BUNNEL	Cirugía para tendones	XIII	11-12
	Perforadores manuales	XIV	9
BUSCH (VEZIEN)	Tijeras para el cordón umbilical	III	80
BUSCHE	Curetas	XIII	63
CAIRNS	Pinzas hemostáticas	IV	36
CAIRNS (CLOVIS VINCENT)	Raspadores y elevadores	XIII	37
CANNY-RYALL	Separadores	VII	36
	Cánulas	XV	27
	Cánulas aspirantes	XV	26
CAPENER	Gubias	XIII	83
CAROLL	Cirugía para tendones	XIII	13
CARPENTER	Raspadores y elevadores	XIII	28
CARREL	Clamp bulldog	V	9
	Pinzas hemostáticas	IV	16
CASPAR	Curetas	XIII	64
	Ganchos	XIII	25
	Mangos de bisturí, hojas desechables	I	6
	Pinzas para laminectomía	XI	12-13
	Raspadores	XIII	39
	Separadores	VII	46
	Separadores	XI	7
CASTANEDA	clamps para recién nacidos y pediátrico	V	39
CASTROVIEJO	Microcirugía porta-agujas	X	12
	Microcirugía tijeras	X	5,8
	O.R.L. ganchos	XII	46
CATLIN	Instrumentos para amputación	XIII	16
CAUCHOIX	Osea cincelas, gubias	XIII	77
	Separadores	VII	144
CHADWICK	Tijeras finas	III	39
CHANDLER	Separadores	VII	106, 141
CHAPUT	Pinzas a presión	IV	93
CHAPUT-MAYO	Pinzas a presión	IV	93
CHARNLEY	Curetas	XIII	65
	Separador, manos de plomo	XIII	143
CHARRIER	Separadores	VII	37
CHARRIERE	Instrumentos para amputación	XIII	18-19
CHATELIER	O.R.L. pinzas a presión	XII	14
CHEATLE	Materiales varios	XV	32
CHERON	Pinzas para vendajes	IV	119
CHEVALIER-JACKSON	O.R.L. pinzas para esofagoscopia	XII	36
CHEVRET	Separadores	VII	40
CHRISTOPHE	Pinzas hemostáticas	IV	33
	Pinzas hemostáticas Prestige	IV	117
CHROBACK	Pinzas uterinas	VIII	24
CINELLI	O.R.L. osteotomos	XII	39
CIRCERON (MATHIEU)	Diverso	VIII	81
	Cirugía para tendones	XIII	11-14
CITELLI	O.R.L. sacabocados	XII	27
	Clamp bulldog	V	9-11
	clamps para recién nacidos y pediátrico	V	37-39
CLAOUÉ	O.R.L. separadores	XII	48
CLEVELAND	Pinzas cortantes	XIII	117
	Pinzas gubias	XIII	103
CLOVIS VINCENT	Espátulas	XI	3
	O.R.L. mazos y curetas	XII	56
	Perforador	XI	9
	Pinzas para disección muy finas	II	11
CLOVIS-VINCENT	Raspadores	XIII	48
CLOWARD	Curetas	XIII	59
	Ganchos	XIII	24
COAKLEY	O.R.L. mazos y curetas	XII	55
COBB	Raspadores	XIII	51
COLLER-CRILE	Pinzas hemostáticas	IV	30
COLLIN	Costotomos	XIII	121
	Espéculos vaginales	VIII	31
	Pinzas a presión	IV	87, 90
	Pinzas para coger el útero	VIII	52



		Capítulo	Página
COLLIN	Separadores	VII	34, 79-80
COLLIN POZZI	Pinzas uterinas	VIII	13
COLVER	O.R.L. pinzas a presión	XII	13
CONVERSE	O.R.L. ganchos	XII	47
	Porta agujas	VI	14
COOLEY	clamps para recién nacidos y pediátrico	V	37-38
	Dilatadores vasculares	V	40
	Pinzas clamps vasculares atrauma	V	33-37
	Pinzas para disección vasculares	II	42
	Separadores	VII	102
COOLEY-DERRA	Pinzas clamps vasculares atrauma	V	34
CORYLLOS	Separadores	VII	53
Costotomos		XIII	121-125
COTT	Separadores	VII	77
COTT (À LAMBEAUX)	Pinzas uterinas	VIII	24
COTTLE	Martillos	XIII	89
	O.R.L. cinceles y gubias	XII	37
	O.R.L. ganchos	XII	47
	O.R.L. raspas	XII	43
	Raspadores	XIII	43
	Raspadores y elevadores	XIII	31
	Separadores, ganchos	VII	10
	Tijeras ORL	III	84
	Tijeras Prestige	III	79
COTTLE (KILLIAN)	O.R.L. espéculos	XII	18
COTTLE NEIVERT	O.R.L. ganchos	XII	47
COURTY	Separadores	VII	131
CRAFOORD	Pinzas hemostáticas largas	IV	43
	Tijeras para intervención en profundidad	III	51
CRAFOORD (SELLORS)	Pinzas hemostáticas especiales	IV	45
CRAIG-DOMNICK	O.R.L. pinzas a presión	XII	15
CRAWFORD	Separadores	VII	36
CREED	Raspadores y elevadores	XIII	28
CRILE	Ganchos	XIII	25
	Pinzas hemostáticas	IV	28-29
	Pinzas hemostáticas Prestige	IV	117
	Separadores	VII	33
CRILE MURAY	Porta agujas	VI	11
CRILE-WOOD	Instrumentación de servicio	XV	18
	Porta agujas	VI	11, 15
	Curetas	XIII	52-65
	Curetas para vías biliares	IX	12-13
	Curetas uterinas	VIII	68-77
CUSCHING-KOCHER	Separadores	VII	17
CUSCO	Espéculos vaginales	VIII	33-34
CUSHING	Ganchos	XIII	25
	Microcirugía ganchos	X	20
	Perforador	XI	10
	Pinzas para disección boca de tungsteno	II	46
	Pinzas para disección delicadas	II	25
	Raspadores	XIII	41-42
	Separadores	VII	13, 62
CUZZI	Curetas uterinas	VIII	75
CZERNY	Espéculos rectales	VIII	88
	Pinzas para calculos biliares	IX	7
	Pinzas uterinas	VIII	25
DALE	Pinzas clamps vasculares atrauma	V	30
DANDY	Microcirugía ganchos	X	20
	Pinzas hemostáticas	IV	26
DANIS	Instrumentación para hombro	XIII	149
	Instrumentación para ligaduras	XIII	150
	Pinzas de alambre	XIV	29
DARGENT	Pinzas uterinas	VIII	16
	Valvas vaginales	VIII	42
DARTIGUES	Pinzas para coger el útero	VIII	52
DARTIGUES (LAPAROSTAT)	Separadores	VII	94
DAUBENSPECK	Curetas	XIII	60
DAUPHIN	Tijeras delicadas	III	12
	Tijeras quirúrgicas	III	11
DAUTREY	O.R.L. separadores	XII	48
DAVID	Pinzas gubias	XIII	114
DAVIS	Raspadores y elevadores	XIII	27
DAVIS-BOYLE	O.R.L. abre-boca	XII	10
DE MARTEL	Instrumentos para amputación	XIII	20
	Raspadores y elevadores	XIII	37
	Tijeras para cirugía vascular	III	35
DE MARTEL - WOLFSON	Pinzas clamps intestinales y estomacales	IV	80
DE MARTEL (PITANGUY)	Pinzas a presión	IV	84
DEAN	Tijeras diversas	III	45
DEAVER	Separadores	VII	59-60
	Tijeras finas	III	14



	Capítulo	Página
DEBAKEY		
Clamp bulldog	V	10
Dilatadores vasculares	V	40
Pinzas clamps vasculares atrauma	V	13-32
Pinzas para disección boca de tungsteno	II	44
Pinzas para disección vasculares	II	41-43
Porta agujas vasculares	VI	20
Separadores	VII	103, 130
Tijeras de tungsteno	III	69
Tijeras para cirugía vascular	III	33, 36
DEBAKEY (LELAND JONES)		
Pinzas clamps vasculares atrauma	V	14
DEBAKEY BAHNSON		
Pinzas clamps vasculares atrauma	V	25
DEBAKEY CAROTID		
Clamp bulldog	V	11
DEBAKEY DIETHRICH		
Pinzas para disección vasculares	II	43
DEBAKEY GERALD		
Pinzas para disección vasculares	II	43
DEBAKEY GLOVER		
Clamp bulldog	V	11
DEBAKEY MOSQUITO		
Pinzas clamps vasculares atrauma	V	27
DEBAKEY PEAN		
Pinzas clamps vasculares atrauma	V	26
DEBAKEY POTTS		
Pinzas clamps vasculares atrauma	V	12
DEBAKEY RANKIN		
Pinzas clamps vasculares atrauma	V	27
DEBAKEY SATINSKY		
Clamp bulldog	V	11
DEBAKEY-BECK		
Pinzas clamps vasculares atrauma	V	16
DECOULX		
Separadores	VII	123
DELABARRE		
O.R.L. abre-boca	XII	7
DELESTRE		
Tijeras episiotomía	III	81
DEMEL		
Pinzas de alambre	XIV	29
DEMELIN-SUZOR		
Forceps obstetricos	VIII	54
DEMOISELLE		
Empujador de injertos	XIII	144
DENHART		
O.R.L. abre-boca	XII	7
DENIS BROWN		
Separadores	VII	84
Depresor lingual	XV	6-7
DERF		
Porta agujas	VI	8, 14
Dermátomo de mano	I	8-9
DERRA		
Pinzas clamps vasculares atrauma	V	29
DESCHAMPS		
Agujas para ligaduras	VI	32
DESCHAMPS SCHAUTA		
Agujas para ligaduras	VI	31
DESGOUTTES		
Pinzas para disección especiales	II	18
DESJARDINS		
Curetts para vías biliares	IX	12
Instrumentos para vías biliares	IX	11
Pinzas para calculos biliares	IX	6
DESMARET		
Separadores	VII	70
DESMARRES		
Separadores	VII	11
Destornillador	XIV	11-13
DIETRICH		
Pinzas clamps vasculares atrauma	V	18
Dilatadores para vías biliares	IX	14
Dilatadores uterinos	VIII	82-84
Dilatadores vasculares	V	40
DINGMAN		
Separadores	VII	66
DINGMANN		
O.R.L. abre-boca	XII	11
Pinzas para huesos	XIII	127
Disecadores	IV	50-67
DIXON-LOVELACE		
Pinzas hemostáticas	IV	27
DOCKHORN		
Separadores	VII	64
DOUAY		
Pinzas para biopsia	VIII	65
DOUGLAS		
Valvas vaginales	VIII	41
DOYEN		
Agujas para ligaduras	VI	28
Costotomos	XIII	125
Diverso	VIII	81
O.R.L. abre-boca	XII	8
Perforador	XI	9
Pinzas clamps intestinales y estomacales	IV	69, 72
Pinzas de campo	IV	103
Pinzas uterinas	VIII	27
Porta agujas	VI	9
Raspadores y elevadores	XIII	45
Separadores	VII	61
Tijeras diversas	III	27
Valvas vaginales	VIII	37, 46
DOYEN (COURONNE DE TREPAN)		
Perforador	XI	9
DOYEN-ROCHARD		
Separadores	VII	69
DRYSSEN		
Separadores	VII	107
DUBOIS		
Tijeras para intervención en profundidad	III	51
DUBOST		
Separadores	VII	99
Tijeras de tungsteno	III	67
Tijeras para disección	III	20
DUBOST NOGENT		
Separadores	VII	100
DUFOURMENTEL		
O.R.L. raspas	XII	42
Pinzas para disección delicadas	II	32
Pinzas para disección especiales	II	35
DUMONT		
Pinzas hemostáticas	IV	17
DUNHILL		
O.R.L. espéculos	XII	16
DUPLAY		
Pinzas uterinas	VIII	13



		Capítulo	Página
DUPONT	Osteotomos	XIII	67
DURAND	Pinzas para disección especiales	II	17
	Pinzas para disección Prestige	II	50
DUVAL	Pinzas a presión	IV	89-91
	Pinzas para disección especiales	II	21
E.N.T. raspatories		XII	41
ECHLIN	Pinzas gubias	XIII	113
EISELSBERG	Tijeras para cortar hilos	III	31
EMMET	Agujas para ligaduras	VI	29
	Pinzas para vendajes	IV	126
Empujador de injertos		XIII	144-145
Endoespéculos		VIII	36
ENGEL	Instrumentos para amputación	XIII	21
ENGLISH MODEL	Pinzas para disección especiales	II	12
EPPENDORF	Pinzas para biopsia	VIII	66
ERRICO	Perforador	XI	10
ESMARCH	Materiales varios	XV	31
	Tijeras para vendajes	III	30
Espátulas		XI	3-5
Espéculos rectales		VIII	87-88
Espéculos vaginales		VIII	31-35, 50
Espejo laringeo		XV	8
Estiletes		XV	12
Estribos de tracción		XIII	158-161
EUFRATE	Porta agujas vasculares	VI	22
EVANS	Pinzas para disección boca de tungsteno	II	45
EVES	O.R.L. cierra nudos	XII	20
FARABEUF	Bisturís fijos	I	2
	Instrumentos para amputación	XIII	19
	Osea cincelas, gubias	XIII	76
	Pinzas para huesos	XIII	133
	Raspadores y elevadores	XIII	44
	Separadores	VII	31, 42
FARABEUF-CORTI	Separadores	VII	33
FARKAS	Pinzas para disección especiales	II	20
FAVALORO	Tijeras para cirugía vascular	III	36
FEILCHENFELD	Pinzas para astillas	II	51
FERGUSON	O.R.L. canulas aspirantes	XII	58
	Pinzas para huesos	XIII	139
	Tijeras para incisión	III	28
FERRIS SMITH KERRISSON	Pinzas sacabocados	XI	16-23
FERRIS-SMITH-CUSHING	Pinzas para laminectomía	XI	14
FICAT	Punzones y trapanadores	XIII	94
FINOCHIETTO	Disecadores	IV	66
	Porta agujas	VI	10, 18
	Separadores	VII	95-98
FINOCHIETTO-BURFORD	Separadores	VII	107
FINSEN	Separadores	VII	111
FISH	Estiletes	XV	12
	Ganchos	XIII	24
	O.R.L. ganchos	XII	45
FOERSTER	Pinzas para vendajes	IV	124
FOMON	O.R.L. ganchos	XII	46
	O.R.L. raspas	XII	44
	Tijeras ORL	III	83-84
	Tijeras Prestige	III	78
Forceps obstetricos		VIII	53-59
FRAZIER	Microcirugía ganchos	X	19
	O.R.L. canulas aspirantes	XII	57-58
	Raspadores y elevadores	XIII	36
FREER	O.R.L. cinceles y gubias	XII	37
	O.R.L. elevadores	XII	50
	O.R.L. ganchos	XII	46
	O.R.L. gubias	XII	40
	Raspadores y elevadores	XIII	26
FREER-YASARGIL	Raspadores y elevadores	XIII	26
FRENCH	O.R.L. diapasones	XII	59
Fresas y medidores		XIV	10
FRIEDMANN DELIKAT	Pinzas gubias	XIII	101
FRICTSCH	Separadores	VII	61
FRYKHOLM	Pinzas gubias	XIII	113
FUCHSIG	Pinzas hemostáticas	IV	34
FUKUDA	Separadores	VII	142
GALLAHER	O.R.L. raspas	XII	42
Ganchos		XIII	24-25, 95
GELPI	Separadores	VII	130
GEMINI	Disecadores	IV	57
GERALD	Pinzas para disección delicadas	II	30
GIERTZ-STILLE	Costotomos	XIII	123
GIGLI	Instrumentos para amputación	XIII	20
GILLIES	Pinzas para disección delicadas	II	31



		Capítulo	Página
GILLIES	Porta agujas	VI	24
	Separadores, ganchos	VII	9
GILLIES-BABY	Porta agujas	VI	24
GIL-VERNET	Separadores	VII	12
GIL-VERNET (PAPIN)	Separadores	VII	12
GINESTET	O.R.L. separadores y ganchos	XII	49
GLOVER	Pinzas clamps vasculares atrauma	V	28-29
GLUCK	Costotomos	XIII	123
GOELET	Separadores	VII	34
GOLDMANN-FOX	Tijeras de tungsteno	III	66
	Tijeras finas	III	44
GOOD	Tijeras diversas	III	37
GORNEY	Tijeras Prestige	III	77
GOSSET	Separadores	VII	87-88
GOUILLOUD	Pinzas clamps	IV	47
GOURDET	Curetas uterinas	VIII	68
GRAEFE	Microcirugía ganchos	X	18
	Tijeras finas	III	39
GRAHAM	Microcirugía ganchos	X	20
GRAVE	Espéculos vaginales	VIII	34
GRAY	Instrumentos para vías biliares	IX	10
GRAZIL	Tijeras delicadas	III	13
GREEN	Separadores	VII	62
GREEN-ARMYTAGE	Pinzas uterinas	VIII	30
GREGOIRE	Pinzas a presión	IV	88
	Pinzas para disección especiales	II	19
GREGORY	Pinzas clamps vasculares atrauma	V	31
GREGORY SOFT	Clamp bulldog	V	10
GROSS MAYER	Pinzas para vendajes	IV	120
GRUENWALD	O.R.L. sacabocados	XII	28
	Pinzas para disección boca de tungsteno	II	46
Gubias		XIII	78-83
GUERRIER	O.R.L. separadores y ganchos	XII	49
Guía para brocas y clavos IM		XIV	39
Guías de brocas		XIV	14-16
GUILLAUME	Gubias	XIII	78
GUNNAR-HEY	Pinzas diversas	IV	108
GUTHRIE	Microcirugía ganchos	X	19
GUYON	Instrumentos para urología	VIII	86
	Pinzas para pedunculos renales	IX	8
GUYON-FREUDENBERG	Materiales varios	XV	32
HABERER	Separadores	VII	38
HAIGHT	Separadores	VII	102
HAJEK	Martillos	XIII	87
	O.R.L. sacabocados	XII	28
HAKANSSON	Pinzas gubias	XIII	103
HALLE	Curetas	XIII	60
	Raspadores y elevadores	XIII	32
	Separadores rectales	VIII	90
	Tijeras ORL	III	83
HALSEY	Porta agujas	VI	8
HALSEY (WEBSTER)	Porta agujas	VI	13
HALSTEAD	Instrumentación de servicio	XV	19
	Pinzas hemostáticas	IV	20
	Pinzas hemostáticas Prestige	IV	113
HALSTEAD-MOSQUITO	Pinzas hemostáticas	IV	23
HANK	Dilatadores uterinos	VIII	84
HARKEN	Pinzas a presión	IV	83
	Pinzas clamps vasculares atrauma	V	18
HARRINGTON	Disecadores	IV	67
	Separadores	VII	58
HARRINGTON BABY	Separadores	VII	58
HARRINGTON-PEMBERTON	Separadores	VII	58
HARRIS	Pinzas de alambre	XIV	29
HARTMANN	O.R.L. diapasones	XII	59-60
	O.R.L. espéculos	XII	16
	O.R.L. pinzas para orejas	XII	31-32
	O.R.L. pinzas para pólipos	XII	30
	O.R.L. sacabocados	XII	28
	Pinzas clamps intestinales y estomacales	IV	68
	Separadores	VII	36
HARTMANN CITELLI	O.R.L. pinzas para pólipos	XII	30
HARTMANN HALLE	O.R.L. espéculos	XII	18
HARTMANN WEINGARTNER	O.R.L. pinzas para orejas	XII	31
HARVEY	Tijeras para cortar hilos	III	31
HARVEY JACKSON	Separadores	VII	124
HAUTEFEUILLE	Separadores	VII	72
HEANEY	Curetas uterinas	VIII	75
	Pinzas uterinas	VIII	19
	Porta agujas	VI	10
	Separadores	VII	37



		Capítulo	Página
HEANEY-BALLENTINE	Pinzas uterinas	VIII	22
HEATH	Instrumentos de sutura	VI	7
HEGAR	Dilatadores uterinos	VIII	82-84
HEGAR BAUMGARTNER	Porta agujas	VI	11
HEGAR VASCULAR	Porta agujas vasculares	VI	22
HEGAR-OLSEN	Porta agujas	VI	23
HEGAR-OLSEN-BABY	Porta agujas	VI	23
HEGEMANN	Tijeras para cirugía vascular	III	34
HEGENBARTH	Instrumentos de sutura	VI	5
HEIFETZ	Espátulas	XI	5
HEISS	Pinzas hemostáticas largas	IV	38
HEISS (HOLZEIMER)	Separadores	VII	111
HEISTER	O.R.L. abre-boca	XII	8
HELFERICH-BIER	Instrumentos para amputación	XIII	19
HENKE	O.R.L. elevadores	XII	51
HENLEY	Separadores	VII	116
HENNING	Pinza para escayolas	XV	24
HERCULES	Alicates para cortar alambre	XIV	33-35
	Pinzas de alambre	XIV	28
HERRICK	Instrumentos para vías biliares	IX	9
HERTZLER	Separadores	VII	108
HESS	Separadores	XI	8
HEY GROVES	Pinzas para huesos	XIII	137
HEYMANN	Tijeras ORL	III	84
	Tijeras Prestige	III	79
HEYWOOD-SMITH	Pinzas hemorroidales	VIII	94
	Pinzas uterinas	VIII	28
HIBBS	Osea cincelas, osteotomos, gubias	XIII	74
	Separadores	VII	37
HI-LEVEL KNOWLES	Tijeras para incisión	III	28
HOEN	Raspadores y elevadores	XIII	34
HOFFMAN	Pinzas diversas	IV	110
HOHMANN ALDINGER	Separadores	VII	137
HOLSHER	Separadores	XI	8
HOLZBACH	Pinzas uterinas	VIII	21
HONTON	Gubias	XIII	79
HORSLEY	Raspadores y elevadores	XIII	36
HÖSEL	Separadores	VII	46
HOWARTH	Raspadores y elevadores	XIII	27
HRYNITSCHAK	Separadores	VII	92
HUDSON	Perforador	XI	10
HUMBY	Separadores, ganchos	VII	9
HUNTER	Pinzas para astillas	II	51
HURD	O.R.L. elevadores	XII	51
	Hysterómetros	VIII	85
IMA	Microcirugía pinzas finas	X	17
	Instrumentación de servicio	XV	9-20
	Instrumentación para cerclage	XIV	52
	Instrumentación para clavos flexibles	XIV	43-46
	Instrumentación para clavos IM	XIV	40-41
	Instrumentación para clavos RUSH	XIV	42
	Instrumentación para doblar	XIV	20-22
	Instrumentación para grapas	XIV	50-51
	Instrumentación para hombro	XIII	146-149
	Instrumentación para ligaduras	XIII	150
	Instrumentación para menisco	XIII	151-155
	Instrumentación para placas	XIV	17-23
	Instrumentación para rodilla	XIII	156-157
	Instrumentación para tornillos canulados	XIV	47-49
	Instrumentos de sutura	VI	5-7
	Instrumentos para amputación	XIII	15-21
	Instrumentos para autopsia	XIII	22-23
	Instrumentos para escayolas	III	85
	Instrumentos para ligaduras	VI	33-34
	Instrumentos para prostate	VIII	95-96
	Instrumentos para urología	VIII	86
	Instrumentos para vías biliares	IX	9-11
IOWA	Pinzas uterinas	VIII	10
ISRAEL	Separadores	VII	29
ISSELIN	Punzones	XIII	91
IVG	Diverso	VIII	81
J. L. FAURE	Pinzas para biopsia	VIII	62
J.L. FAURE	Pinzas para disección especiales	II	19
JACKSON	Separadores	VII	15
	Valvas vaginales	VIII	44
JACOBS	Pinzas uterinas	VIII	10
JACOBSON	Curetás	XIII	53
	Microcirugía porta-agujas	X	13
JACOBSON ADSON	Pinzas para disección delicadas	II	23
JACOBSON HALSTEAD	Pinzas hemostáticas	IV	22
JACOBSON-ADSON	Disecadores	IV	56



		Capítulo	Página
JAMESON	Porta agujas	VI	12
	Tijeras largas y finas	III	46
	Tijeras Prestige	III	73
JANSEN	Curetas	XIII	54
	Pinzas gubias	XIII	105, 108
	Pinzas para disección O.R.L.	II	40
	Raspadores	XIII	41
	Separadores	VII	112
JANSEN (MIDDLETON)	O.R.L. sacabocados	XII	29
JANSEN-DEEP	Separadores	VII	112
JAVID	Pinzas clamps vasculares atrauma	V	33
JAYLE	Espéculos vaginales	VIII	32
	Valvas vaginales	VIII	48
JENNINGS	O.R.L. abre-boca	XII	9
JESCO	Tijeras diversas	III	56
JL FAURE	Pinzas uterinas	VIII	15, 17
JOHNS HOPKINS	Clamp bulldog	V	9
JOLL	Separadores	VII	131
JONES	Pinzas de campo	IV	103
JOSEPH	O.R.L. Instrumentos de Joseph	XII	52-53
	Tijeras ORL	III	83
	Tijeras Prestige	III	76
JOST	Raspadores y elevadores	XIII	29
	Pinzas a presión	IV	95
JUDD-MASSON	Separadores	VII	93
JUDET	Martillos	XIII	90
	Osea cincelas, osteotomos, gubias	XIII	75
	Separadores	VII	140
	Separadores	VII	55
KADER	Separadores	VII	55
KANTROWITZ	Disecadores	IV	61
KATZIN	Microcirugía tijeras	X	7
KATZIN-BARRAQUER	Microcirugía tijeras	X	7
KAYE	Tijeras Prestige	III	77
KAZANJIAN	Pinzas cortantes	XIII	117
KELLY	Anuscopios	VIII	89
	Pinzas hemostáticas	IV	31
	Pinzas hemostáticas Prestige	IV	116
	Pinzas uterinas	VIII	28
	Separadores	VII	50, 55
	Tijeras de tungsteno	III	57
	Tijeras largas y finas	III	48
KELLY-RANKIN	Pinzas hemostáticas	IV	32
KERN	Pinzas para huesos	XIII	135
KERRISSON	O.R.L. sacabocados	XII	27
KEVORKIAN	Curetas uterinas	VIII	77
	Pinzas para biopsia	VIII	66-67
KEY	Raspadores	XIII	41
	Forceps obstetricos	VIII	55
KIELAND	Separadores	VII	19
KIENNY	O.R.L. elevadores	XII	50
KILLIAN	O.R.L. gubias	XII	40
	O.R.L. ganchos	XII	47
	Porta agujas	VI	13
KILNER	Separadores, ganchos	VII	10
	Tijeras delicadas	III	15
	Tijeras de tungsteno	III	57
KILNER (RAGNELL)	Tijeras de tungsteno	III	57
KILNER-DOUGHTY	O.R.L. abre-boca	XII	11
KIRSCH	Separadores	VII	64
KIRSCHNER	Estribos de tracción	XIII	158-159
	Instrumentos para ligaduras	VI	34
	Separadores	VII	83
KIRSCHNER (AMERICAN)	Estribos de tracción	XIII	160
KLAPP	Separadores	VII	20
KLEINERT-KUTZ	Cirugía para tendones	XIII	13
	Separadores, ganchos	VII	9
KLEINSCHMIDT	Pinzas clamps intestinales y estomacales	IV	77
KLINKENBERG	Tijeras de tungsteno	III	67
	Tijeras diversas	III	50
KNAPP	O.R.L. ganchos	XII	46
	Tijeras finas	III	38
KNOWLES	Tijeras para incisión	III	28
KOCHER	Instrumentación de servicio	XV	18
	O.R.L. bistouris espátulas	XII	25
	Pinzas clamps intestinales y estomacales	IV	73-74
	Pinzas hemostáticas	IV	9-11
	Pinzas hemostáticas Prestige	IV	116
	Separadores	VII	26-27, 43-49
	Separadores	VII	42
KOCHER-LANGENBECK	Separadores	VII	46
KOCHER-WAGNER	Separadores	VII	46
KOENING	Ganchos	XIII	95
KOGAN	Endoespéculos	VIII	36



		Capítulo	Página
KÖLBEL	Instrumentación para hombro	XIII	146
KÖNIG	Instrumentos para ligaduras	VI	33
	Raspadores y elevadores	XIII	35
	Separadores	VII	13
KÖRTE	Separadores	VII	28-29, 48
KÖRTE-WAGNER	Separadores	VII	28
KRAEMER	Raspadores	XIII	43
KRAMER	Raspadores	XIII	41
KRAUSE	O.R.L. cierra nudos	XII	21
	Trocares	XV	30
KRAUSE-VOSS	O.R.L. cierra nudos	XII	21
KRISTELLER	Valvas vaginales	VIII	44
KRÖNLEIN	Pinzas hemostáticas	IV	17
KÜMMEL	Separadores	VII	48
LA GRANGE	Tijeras finas	III	38
LA HEY (SWEET)	Disecadores	IV	60
LABORDE	O.R.L. dilatadores	XII	12
LAGROT	Dermátomo de mano	I	9
LAHEY	O.R.L. pinzas a presión	XII	14
	Separadores	VII	27
LAMBERT KAY	Pinzas clamps vasculares atrauma	V	22
LAMBOTTE	Ganchos	XIII	95
	Osteotomos	XIII	67
	Pinzas específicas	XIV	25
	Pinzas para huesos	XIII	134
	Raspadores	XIII	49
	Separadores	VII	145
	Osteotomos	XIII	66
LAMBOTTE (PAUWELLS)			
LANDANGER	Instrumentación para menisco	XIII	153
	Pinzas para biopsia	VIII	64
	Pinzas para huesos	XIII	128
	Pinzas para vendajes	IV	122
LANDAU	Trocares	XV	30
	Valvas vaginales	VIII	43
LANDOLT	Mangos de bisturís, hojas desechables	I	6
	Tijeras diversas	III	45
LANE	Pinzas clamps intestinales y estomacales	IV	79
	Pinzas para disección especiales	II	13
	Separadores	VII	141
LANE (KERN)	Pinzas para huesos	XIII	135
LANE (PAUCHET)	Pinzas diversas	IV	109
LANE TRETOWAN	Separadores	VII	141
LANGE	Instrumentos para escayolas	III	85
LANGE-HOHMANN	Separadores	VII	133-137
LANGENBECK	Instrumentos para amputación	XIII	16-17
	Pinzas para huesos	XIII	139
	Porta agujas	VI	26
	Raspadores	XIII	42, 47
	Raspadores y elevadores	XIII	33
	Separadores	VII	44
LANGENBECK (LARREY)	Instrumentos para amputación	XIII	18
LANGENBECK-GREEN	Separadores	VII	17, 20
LARDENOIS	Separadores	VII	38-39
LAWRENCE	Disecadores	IV	60
LAZAR	Microcirugía pinzas finas	X	16
LE MEE	Depresor lingual	XV	7
	O.R.L. espéculos	XII	16
LEBEAU	O.R.L. gubias	XII	40
	Raspadores y elevadores	XIII	34
LEBSCHÉ	Costotomos	XIII	125
LECOUTEUR	Depresor lingual	XV	7
LEES	Pinzas clamps vasculares atrauma	V	19
LEGUEU	Pinzas clamps	IV	46
	Separadores	VII	60, 93
LEKSELL- STILLE	Pinzas gubias	XIII	112
LELIEVRE	O.R.L. cinceles y gubias	XII	38
	Raspadores	XIII	48
LEMAIRE	Instrumentación para rodilla	XIII	156
LEMPERT	Curetas	XIII	61
	O.R.L. elevadores	XII	51
	Pinzas gubias	XIII	106
LEPAGE	Pinzas uterinas	VIII	26
LERAT	Pinzas para huesos	XIII	142
LERICHE	Instrumentación de servicio	XV	19
	Pinzas hemostáticas	IV	25
	Pinzas hemostáticas Prestige	IV	114
	Raspadores y elevadores	XIII	33
	Separadores, ganchos	VII	10
	Valvas	VII	57
LERICHE-BUGATTI	Valvas	VII	57
LERMOYER	O.R.L. cuchillos para vegetaciones	XII	23



		Capítulo	Página
LETOURNEL	Curetás	XIII	65
LEVRET	Forceps obstetricos	VIII	58
LEWIN	Pinzas para huesos	XIII	142
LEWIS	O.R.L. raspas	XII	43
LEXER	Osea cincelas, gubias	XIII	82
	Osteotomos, gubias	XIII	81
	Tijeras para disección	III	21
LEXER-FINO	Tijeras de tungsteno	III	60-61
	Tijeras para disección	III	21
LICHTENBERG	Porta agujas	VI	26
LICHTWITZ	Trocares	XV	30
LIEGE	Pinzas a presión	IV	99
LIMA	O.R.L. mazos y curetas	XII	54
LISTER	Instrumentación de servicio	XV	15
	Pinzas para vendajes	IV	126
	Tijeras de tungsteno	III	66
	Tijeras para vendajes	III	29
LISTER-EXCENTRIC	Tijeras para vendajes	III	30
LISTON	Costotomos	XIII	121
	Instrumentos para amputación	XIII	15
	Pinzas cortantes	XIII	116, 119
LISTON-KEY (HORSLEY)	Pinzas cortantes	XIII	120
LITTAUER	Tijeras para cortar ligaduras	III	42
LITTAUER-LISTON	Pinzas cortantes	XIII	117
LITTLER	Tijeras para cortar ligaduras	III	42
LITTLEWOOD	Pinzas a presión	IV	99
LOCHARD	Pinzas diversas	IV	110
LOCKHART MUMMARY	Sondas acanaladas	XV	13
LOCKLIN	Tijeras finas	III	44
LOCKWOOD	Pinzas a presión	IV	90
LOCKWOOD-ALLIS	Pinzas a presión	IV	97
LOMBARD	Martillos	XIII	89
	Pinzas gubias	XIII	98
LORENZ	Tijeras para vendajes	III	29
LORNA	Pinzas de campo	IV	106
LORTAT-JACOB	Materiales varios	XV	32
LOUTE	Pinzas de alambre	XIV	29
LOVE	Separadores	XI	6-7
LOVE (MORSE)	Separadores	VII	13
LOVE-ADSON	Raspadores	XIII	38
LOVELACE	Pinzas a presión	IV	92
LOWE	Separadores	VII	14
LOWER	Disecadores	IV	59
LOWMAN	Pinzas para huesos	XIII	141
LOWMAN-HOGLUND	Pinzas para huesos	XIII	141
LUBET BARBON	O.R.L. pinzas a presión	XII	13
LUC	O.R.L. pinzas a presión	XII	15
LUCAE	Martillos	XIII	87
	O.R.L. diapasones	XII	60
	O.R.L. ganchos	XII	45
	Pinzas para disección O.R.L.	II	40
LUCAE HARTMANN	O.R.L. diapasones	XII	59
LUCAS	Osea cincelas, gubias	XIII	68
	Osea cincelas, osteotomos, gubias	XIII	74
LUCAS-CHAMPIONNIERE	Trephine y perforadores	XIV	37
LUER	Pinzas gubias	XIII	103-104
	Separadores	VII	33
LUER KOERTE	Curetás para vías biliares	IX	13
LUER LOCK	Cánulas	XV	27
LUER-FRIEDMANN	Pinzas gubias	XIII	101
LUKENS	Separadores	VII	15
MAC EVEN	Martillos	XIII	86
	Osea cincelas, osteotomos, gubias	XIII	75
MAC INDOE	Pinzas cortantes	XIII	118
MAC KEE	Separadores	VII	117
MAGILL	Instrumentación de servicio	XV	9
MAINGOT	Pinzas uterinas	VIII	21
MALTZ	O.R.L. raspas	XII	42
	Mandriles	XIV	7
	Mandriles universales	XIV	8
MANGIAGALLI	Valvas vaginales	VIII	41
	Mangos de bisturís, hojas desechables	I	3-6
MARKHAM-MEYERDING	Separadores	VII	128
MARQUARDT	Pinzas gubias	XIII	110
	Martillos	XIII	85-90
	Martillos a reflejos, Estetoscopio	XV	5
MARTIN	Pelvimetros	VIII	78
	Separadores	VII	51
MARTIN (SIMPSON)	Hysterómetros	VIII	85
MARTIN-CARTILAGE	Tijeras diversas	III	37
MARTINI	Curetás	XIII	53



		Capítulo	Página
MASING	O.R.L. elevadores	XII	50
MASING (NEIVERT)	Porta agujas	VI	13
MASING (SILVER)	O.R.L. osteotomos	XII	39
MASSON	Porta agujas	VI	12
MASSON	Porta agujas	VI	17
Materiales varios		XV	31-33
MATHEY	Separadores	VII	110
MATHIEU	Espéculos rectales	VIII	87
	Pinzas uterinas para polipas	VIII	11
	Porta agujas	VI	12, 25
	Separadores	VII	35
	Valvas vaginales	VIII	46
MAURER	Costotomos	XIII	122
	Raspadores	XIII	50
	Separadores	VII	110, 146
MAYFIELD	Pinzas gubias	XIII	110
MAYO	Depresor lingual	XV	6
	Instrumentación de servicio	XV	16
	Materiales varios	XV	32
	Pinzas para disección especiales	II	17
	Tijeras de tungsteno	III	59
	Tijeras para disección	III	16
	Tijeras Prestige	III	70
	Pinzas para calculos biliares	IX	7
MAYO BLAKE			
MAYO -HEGAR	Porta agujas	VI	16
MAYO ROBSON	Pinzas clamps intestinales y estomacales	IV	71
MAYO-ADAMS	Separadores	VII	81
MAYO-ALSACE	Tijeras para disección	III	18
MAYO-HARRINGTON	Tijeras para disección	III	19
MAYO-HEGAR	Instrumentación de servicio	XV	18
	Porta agujas	VI	11, 17-18
MAYO-LEGER	Tijeras para disección	III	18
MAYO-LEXER	Tijeras de tungsteno	III	60-61
	Tijeras Prestige	III	70
MAYO-LYON	Tijeras para disección	III	18
MAYO-NOBLE	Tijeras para disección	III	19
MAYO-SANTY	Tijeras para disección	III	19
MAYO-STILLE	Tijeras de tungsteno	III	60-61
	Tijeras para disección	III	17
	Tijeras Prestige	III	70
MC DONALD	Raspadores y elevadores	XIII	31
MC GIVNEY	Pinzas hemorroidales	VIII	94
MC INDOE	Pinzas para disección boca de tungsteno	II	47
	Pinzas para disección delicadas	II	31
Mc KENTY	O.R.L. elevadores	XII	50
	Raspadores	XIII	39
MC LEAN	Forceps obstetricos	VIII	55
MC-INDOE	Tijeras diversas	III	37
McKENZIE	Perforador	XI	10
MEAD	Martillos	XIII	88
	Pinzas gubias	XIII	102
Medidores		XIII	96
MEEKER	Disecadores	IV	63
MERCEDES	Separadores	VII	105
MERIAM	Pinzas para disección delicadas	II	29
MERLE D'AUBIGNÉ	Instrumentación para hombro	XIII	148
	Punzones	XIII	92
	Raspadores	XIII	49
	Separadores	VII	139-140
MERLE D'AUBIGNÉ (BANKART)	Instrumentación para hombro	XIII	147
MERVEILLEUX	Tijeras Prestige	III	75
METZENBAUM	Instrumentación de servicio	XV	17
	Instrumentos para prostate	VIII	95
	Tijeras de tungsteno	III	62
	Tijeras para disección	III	22-23
	Tijeras Prestige	III	71
METZENBAUM-FINO	Tijeras de tungsteno	III	63-65
	Tijeras para disección	III	24
	Tijeras Prestige	III	71
MEYERDING	Separadores	VII	18, 49
MICHEL	Instrumentos de sutura	VI	5-7
MICHELE	Trephine y perforadores	XIV	37
MICHON	Pinzas clamps	IV	46
MICRO	Tijeras finas	III	38
MICRO ADSON	Pinzas para disección boca de tungsteno	II	47
	Pinzas para disección delicadas	II	23
MICRO -HALSTEAD	Pinzas hemostáticas	IV	20
MICRO -MOSQUITO	Pinzas hemostáticas	IV	21
Microcirugía ganchos		X	18-20
Microcirugía pinzas finas		X	15-17
Microcirugía porta-agujas		X	12-14



		Capítulo	Página
Microcirugía tijeras		X	3-11
MICRO-RYDER	Porta agujas vasculares	VI	21
MIDDELDORPF	Separadores	VII	61-62
MIKULICZ	Pinzas hemostáticas especiales	IV	48-49
	Separadores	VII	54
MILLER	O.R.L. raspas	XII	44
MILLES	Microcirugía tijeras	X	9
MILLIGAN	Raspadores y elevadores	XIII	28
MILLIN	Instrumentos para prostate	VIII	95
	Separadores	VII	93
MILLS	Tijeras para cirugía vascular	III	35
MINI GEMINI	Disecadores	IV	57
MINI LEXER	Osteotomos, gubias	XIII	81
MINI TO WNSEND	Pinzas para biopsia	VIII	67
MINI-FRIEDMANN	Pinzas gubias	XIII	101
MINI-LANGENBECK	Separadores	VII	16
MIRIZZI	Pinzas para calculos biliares	IX	4-5
MITCHELL	Raspadores	XIII	42
MIXTER	Disecadores	IV	58-59
	Tijeras finas	III	14
MIXTER-O'SHAUGNESSY	Disecadores	IV	58
MOHR	Pinzas diversas	IV	110
MOLT	Raspadores y elevadores	XIII	27
MONOD	Trocares	XV	28
MONESTRUC	Separadores	VII	87
MOORE	Curetas para vías biliares	IX	13
	O.R.L. pinzas y cizalla	XII	34
MOORE LAMBOTTE	Separadores	VII	145
MOREL FATIO	Raspadores y elevadores	XIII	27
MORRIS	Separadores	VII	52
MORRIS DEBAKEY	Pinzas clamps vasculares atrauma	V	24
MORSE-FAVALORO	Separadores	VII	105
MOSQUITO	Pinzas hemostáticas	IV	19
MOYNIHAN	Pinzas hemostáticas	IV	36
	Pinzas hemostáticas largas	IV	43
MUHLING	Raspadores	XIII	40
MULLER	Phlebectomy	V	7
MURPHY	Instrumentación de servicio	XV	20
	Instrumentación para rodilla	XIII	156
	Pinzas para tubos	IV	112
	Separadores	VII	23
MUSEUX	Pinzas para huesos	XIII	142
	Pinzas uterinas	VIII	7-8
MUSEUX PALMER	Pinzas uterinas	VIII	9
MUSEUX PALMER-CHERON	Pinzas uterinas	VIII	9
MYERS	Sondas para varices	V	5
MYRTLE	Sondas acanaladas	XV	13
NABATOFF	Sondas para varices	V	5
NAGELE	Forceps obstetricos	VIII	56
NANCY	Gubias	XIII	78
	Tijeras diversas	III	27
NEFF	Instrumentación para menisco	XIII	151
NEGUS	Pinzas clamps intestinales y estomacales	IV	69
NEIVERT	Porta agujas	VI	14
NELATON	Bisturís fijos	I	2
	Sondas acanaladas	XV	13
	Trephine y perforadores	XIV	37
NELSON	Trocares	XV	29
NEW ORLEANS	Porta agujas	VI	17
NEW SUTURE	Tijeras para incisión	III	28
NICOLLET-KOCHER	Instrumentación para menisco	XIII	153
NICOLLET-MUSEUX	Instrumentación para menisco	XIII	153
NISSSEN	Instrumentos para vías biliares	IX	11
	Pinzas hemostáticas	IV	35
NORFOLK-NORWICH	Separadores	VII	117
NORTHFIELD	Pinzas gubias	XIII	107
NOTO	Pinzas uterinas	VIII	28
NOTTER	Diverso	VIII	60
NOVAC	Diverso	VIII	80
NOYES	Microcirugía tijeras	X	6
NUBOER	Cánulas aspirantes	XV	26
NUSSBAUM	Pinzas clamps intestinales y estomacales	IV	78
O.R.L. abre-boca		XII	7-11
O.R.L. agujas e para paracentesis		XII	22
O.R.L. amigdalotomo		XII	26
O.R.L. bistouris espátulas		XII	25
O.R.L. canulas aspirantes		XII	57-58
O.R.L. cierra nudos		XII	20-21
O.R.L. cinceles y gubias		XII	37-38
O.R.L. cuchillos para vegetaciones		XII	23-24
O.R.L. diapasones		XII	59-60



	Capítulo	Página	
O.R.L. dilatadores	XII	12	
O.R.L. elevadores	XII	50-51	
O.R.L. espéculos	XII	16-19	
O.R.L. ganchos	XII	45-47	
O.R.L. gubias	XII	40	
O.R.L. Instrumentos de Joseph	XII	52-53	
O.R.L. mazos y curetas	XII	54-56	
O.R.L. micro instrumentos	XII	33	
O.R.L. osteotomos	XII	39	
O.R.L. pinzas a presión	XII	13-15	
O.R.L. pinzas para esofagoscopia	XII	36	
O.R.L. pinzas para orejas	XII	31-32	
O.R.L. pinzas para pólipos	XII	30	
O.R.L. pinzas para reposicionar	XII	35	
O.R.L. pinzas y cizalla	XII	34	
O.R.L. raspas	XII	42-44	
O.R.L. sacabocados	XII	27-29	
O.R.L. separadores	XII	48	
O.R.L. separadores y ganchos	XII	49	
OBWEGESER	Osteotomos	XIII	67
	Separadores	VII	63, 65
OCHSNER	Pinzas clamps vasculares atrauma	V	17
OEHLER	Pinzas para disección boca de tungsteno	II	45
OLIVECRONA	Espátulas	XI	4
	Instrumentos para amputación	XIII	20
	Pinzas gubias	XIII	106
	Raspadores y elevadores	XIII	26
OLIVIER	Separadores	VII	82
OLLIER	Instrumentación para rodilla	XIII	157
	Pinzas para huesos	XIII	136, 140
	Raspadores y elevadores	XIII	44
	Separadores	VII	30
OMBREDANNE	Martillos	XIII	85
	Osea cincelas, gubias	XIII	70
	Pinzas a presión	IV	98
	Punzones	XIII	91
OPEN COELIO	Separadores	VII	33
OSCHNER	Pinzas para disección delicadas	II	33
Osea cincelas, gubias		XIII	68-70, 76-77, 82
Osea cincelas, osteotomos, gubias		XIII	69-75
O'SHAUGNESSY	Disecadores	IV	51-53
	Instrumentos para prostate	VIII	95
Osteotomos		XIII	66-67
Osteotomos, gubias		XIII	81
O'SULIVAN - O'CONNOR	Separadores	VII	85
OUPET	Pinzas clamps	IV	47
OVERHOLT -GEISSENDORFER	Disecadores	IV	54
OVERHOLT -S	Disecadores	IV	55
OVERHOLT -SLIM	Disecadores	IV	55
OVERHOLT-MIXTER	Disecadores	IV	61
PAJOT	Forceps obstetricos	VIII	55
PALMER	Dilatadores uterinos	VIII	82
	Pinzas uterinas para polipas	VIII	11
	Separadores	VII	78
Para huesos		XIV	24
PARKER	Separadores	VII	35
PARKER LANGENBECK (US ARMY)	Separadores	VII	35
PARKER-MOTT	Separadores	VII	36
PARTSCH	Martillos	XIII	85
	Osea cincelas, gubias	XIII	68
PARTSCH (HAUTANT)	O.R.L. cinceles y gubias	XII	38
PASSOW	Empujador de injertos	XIII	144
PATTERSON	Pinzas para biopsia	VIII	66
PAUCHET	Instrumentos de sutura	VI	5
PAUCHET (SABRE)	Agujas para ligaduras	VI	29
PAYR	Instrumentos para ligaduras	VI	34
	Pinzas clamps intestinales y estomacales	IV	75
PAYR (BABY)	Pinzas clamps intestinales y estomacales	IV	75
PEAN	Instrumentación de servicio	XV	17
	Pinzas para vendajes	IV	118
	Trocars	XV	30
PEDERSON	Espéculos vaginales	VIII	35
PEERS	Pinzas de campo	IV	105
PEET	Pinzas para astillas	II	52
PELKMANN	Pinzas para vendajes	IV	127
Pelvimetros		VIII	78
PENFIELD	Raspadores y elevadores	XIII	30
PENNINGTON	E.N.T. raspatories	XII	41
	Pinzas a presión	IV	89
PENNYBACKER	Pinzas gubias	XIII	107
	Raspadores	XIII	42



		Capítulo	Página
PERCY	Instrumentos para amputación	XIII	21
Perforador		XI	9-10
Perforadores manuales		XIV	9
PERRY	Pinzas para disección delicadas	II	37
PERTHES	Punzones	XIII	93
PETIT DUTAILLY	Raspadores y elevadores	XIII	37
PHANEUF	Pinzas uterinas	VIII	22
Phlebectomy		V	7-8
PINARD	Martillos a reflejos, Estetoscopio	XV	5
Pinza para escayolas		XV	23-24
Pinzas a presión		IV	81-102
Pinzas clamps		IV	46-47
Pinzas clamps intestinales y estomacales		IV	68-80
Pinzas clamps vasculares atrauma		V	12-37
Pinzas cortantes		XIII	116-120
Pinzas de alambre		XIV	28-29
Pinzas de campo		IV	103-107
Pinzas específicas		XIV	25-26
Pinzas gubias		XIII	97-115
Pinzas hemorroidales		VIII	94
Pinzas hemostáticas		IV	9-36
Pinzas hemostáticas especiales		IV	14, 44-49
Pinzas hemostáticas largas		IV	37-43
Pinzas hemostáticas Prestige		IV	113-117
Pinzas multiservicios		XIV	27
Pinzas para astillas		II	51-52
Pinzas para biopsia		VIII	62-67
Pinzas para biopsia rectal		VIII	92
Pinzas para calculos biliares		IX	4-7
Pinzas para calculos renales		IX	3
Pinzas para coger el útero		VIII	52
Pinzas para disección boca de tungsteno		II	44-47
Pinzas para disección delicadas		II	14-15, 22-37
Pinzas para disección especiales		II	12-21, 34-35
Pinzas para disección estándares		II	5-6
Pinzas para disección estrecha		II	8
Pinzas para disección finas curvas		II	10
Pinzas para disección finas rectas		II	9
Pinzas para disección medias finas		II	7
Pinzas para disección muy finas		II	11
Pinzas para disección O.R.L.		II	38-40
Pinzas para disección oftalmológicas		II	36
Pinzas para disección Prestige		II	48-50
Pinzas para disección vasculares		II	41-43
Pinzas para huesos		XIII	126-142
Pinzas para laminectomía		XI	11-15
Pinzas para pedunculos renales		IX	8
Pinzas para tubos		IV	111-112
Pinzas para vasectomía		VIII	93
Pinzas para vendajes		IV	118-127
Pinzas sacabocados		XI	16-23
Pinzas uterinas		VIII	7-30
Pinzas uterinas para polipas		VIII	11
PIPER	Forceps obstetricos	VIII	58
PIRON	Curetas uterinas	VIII	75
PLESTER	O.R.L. canulas aspirantes	XII	57
	Separadores	VII	113
POIRIER	Osea cincelas, gubias	XIII	70
POLITZER	Pinzas para disección O.R.L.	II	39
POLOSSON	Separadores	VII	56
POOLE	Cánulas aspirantes	XV	26
Porta agujas		VI	8-26
Porta agujas vasculares		VI	20-22
Porta algodón		XV	14
POSTEL	Instrumentos para amputación	XIII	18
	Separadores	VII	146
POTTS DE MARTEL	Tijeras para cirugía vascular	III	35
POTTS-SMITH	Pinzas para disección boca de tungsteno	II	46
	Pinzas para disección delicadas	II	26
	Tijeras de tungsteno	III	69
	Tijeras diversas	III	37
	Tijeras para cirugía vascular	III	32, 36
	Tijeras Prestige	III	74
POZZI	Curetas uterinas	VIII	76
	Instrumentación para hombro	XIII	148
	Pinzas uterinas	VIII	12
POZZI CHERON	Diverso	VIII	80
POZZI PALMER	Pinzas uterinas	VIII	12
PRATT	Dilatadores uterinos	VIII	84
	Espéculos rectales	VIII	87
	Pinzas a presión	IV	102



		Capítulo	Página
PRATT	Pinzas uterinas	VIII	25
PRECELLE	Pinzas para disección delicadas	II	37
PRICE THOMAS	Pinzas a presión	IV	81
PRINCE	Tijeras diversas	III	37
PROVIDENCE	Pinzas hemostáticas	IV	26
Punzones		XIII	91-93
Punzones y trapanadores		XIII	94
PUTTI	Raspas	XIII	84
QUENU	Pinzas clamps intestinales y estomacales	IV	68
	Pinzas para disección especiales	II	20
QUILICY FAR ISSE	Disecadores	IV	62
QUINBY	Tijeras diversas	III	45
QUIRE	O.R.L. pinzas para orejas	XII	32
RACHIS NOGENT	Separadores	VII	106
RAGNEL (DAVIS)	Separadores	VII	19
RALK	Perforadores manuales	XIV	9
RAMPLEY	Pinzas para vendajes	IV	123
RAMUS	Separadores	VII	65
RANDALL	Pinzas para calculos renales	IX	3
Raspadores		XIII	38-51
Raspadores y elevadores		XIII	26-45
Raspas		XIII	84
RECAMIER	Curetts uterinas	VIII	74
REDON	Agujas para ligaduras	VI	30
	Disecadores	IV	50
RESANO	Disecadores	IV	67
REVERDIN	Agujas de sutura	VI	27
REVERDIN (PAUCHET)	Separadores	VII	39
REVERSIBLE	Separadores	VII	101
REYNOLDS	Tijeras largas y finas	III	46
	Tijeras Prestige	III	73
RICARD	Separadores	VII	73, 75
RICARD-BEGOIN	Separadores	VII	74
RICHARDSON	Separadores	VII	50
RICHARDSON-EASTMAN	Separadores	VII	50
RICHTER	Tijeras para incisión	III	28
RIZZUTI	Raspadores y elevadores	XIII	26
ROBB	Raspadores y elevadores	XIII	29
ROBERTS	Pinzas hemostáticas largas	IV	41
ROBIN	O.R.L. cinceles y gubias	XII	37
ROCHARD	Pinzas uterinas	VIII	26
	Separadores	VII	67-68
ROCHER	Punzones y trapanadores	XIII	94
ROCHESTER-CARMALT	Pinzas hemostáticas especiales	IV	14
ROCHESTER-OSCHNER	Pinzas hemostáticas	IV	13
ROCHESTER-PEAN	Pinzas hemostáticas	IV	12
ROEDER	Pinzas de campo	IV	107
ROGERS	Pinzas uterinas	VIII	18
ROLLET	O.R.L. ganchos	XII	46
ROSE	Separadores	VII	15
RÖTTGEN-RUSKIN	Pinzas gubias	XIII	112
ROUENNAIS	Tijeras diversas	III	55
ROUX	Raspadores	XIII	47
	Separadores	VII	34
ROWE	O.R.L. pinzas para reposicionar	XII	35
RUALT	O.R.L. bistouris espátulas	XII	25
RUBIN	O.R.L. pinzas y cizalla	XII	34
RUMEL	Disecadores	IV	63
RUMEL BELMONT	Phlebectomy	V	7
RUSKIN	Pinzas gubias	XIII	110
RUSKIN-LISTON	Pinzas cortantes	XIII	118
RUSSIAN MODEL	Pinzas para disección especiales	II	17
RYDER	Porta agujas vasculares	VI	21
SACHS	Raspadores y elevadores	XIII	36
SAENGER	Pinzas uterinas	VIII	30
SANTORINI	Instrumentos para prostate	VIII	95
SANTULLI	Clamp bulldog	V	10
SANTY	Cánulas aspirantes	XV	26
	Pinzas hemostáticas largas	IV	42
SANVENERO	Tijeras largas y finas	III	49
SAROT	Pinzas hemostáticas largas	IV	41
	Porta agujas vasculares	VI	22
SATINSKY	Pinzas a presión	IV	82
	Pinzas clamps vasculares atrauma	V	22
	Tijeras diversas	III	50
SATTERLEE	Instrumentos para amputación	XIII	18
SAUERBRUCH	Costotomos	XIII	124
	Pinzas gubias	XIII	114
	Separadores	VII	51, 53
SAUERBRUCH-FREY	Costotomos	XIII	124
SCHADEL	Pinzas de campo	IV	103



		Capítulo	Página
SCHEDÉ	Curetas	XIII	57
SCHÉIBE	Pinzas clamps intestinales y estomacales	IV	70
SCHERBAK	Espéculos vaginales	VIII	50
SCHINK	Dermátomo de mano	I	8
SCHMID	Sondas y Espatulas	V	6
SCHNIDT	Disecadores	IV	56
SCHOEMAKER-LOTH	Tijeras para cortar hilos	III	31
SCHRÖDER	Curetas uterinas	VIII	72
SCHROEDER	Pinzas uterinas	VIII	13-14
SCHULTZE	Diverso	VIII	79
SCHUMACHER	Pinzas para biopsia	VIII	63
	Separadores	VII	138
	Tijeras para el cordón umbilical	III	80
SCHUMACHER (WAGNER)	Separadores	VII	138
SCHUMAKER	Pinzas para biopsia	VIII	65
SCOVILLE	Curetas	XIII	63
SCUDDER	Pinzas clamps intestinales y estomacales	IV	78
SEBILEAU	E.N.T. raspatories	XII	41
	O.R.L. mazos y curetas	XII	54
	Raspadores y elevadores	XIII	34
SEDILLLOT	Raspadores	XIII	43
SEGOND	Pinzas uterinas	VIII	19
	Separadores	VII	55
SEGOND-LANDAU	Pinzas uterinas	VIII	19
SEGURA	O.R.L. mazos y curetas	XII	54
SELLORS	Separadores	VII	109
SEMB	Disecadores	IV	64
	Pinzas cortantes	XIII	120
	Pinzas gubias	XIII	115
	Pinzas para huesos	XIII	138
	Raspadores	XIII	47
SEMB-SAYLOR	Disecadores	IV	64
SEMKEN	Pinzas para disección boca de tungsteno	II	47
	Pinzas para disección delicadas	II	32
SEMM	Espéculos vaginales	VIII	35
	Separadores	VII	85
SENN GREEN (CHIGOT)	Separadores	VII	16
SENN-MILLER	Separadores	VII	19
SENN-MILLER BABY	Separadores	VII	19
	Separador, manos de plomo	XIII	143
	Separadores	VII	11-146
		XI	6-8
	Separadores rectales	VIII	90-91
	Separadores Valvas maleables	VII	41
	Separadores VK	VII	71
	Separadores, ganchos	VII	9-10
SETTER	Pinzas para huesos	XIII	137
SEUTIN	Pinzas diversas	XV	21
	Tijeras para escayolas	XV	22
SEWALL	Raspadores y elevadores	XIII	36
SEYFFERT	Espéculos vaginales	VIII	35
SHUBERT	Pinzas para biopsia	VIII	62
SICARD	Pinzas gubias	XIII	99
SICART	Raspadores y elevadores	XIII	37
SIEBOLD	Tijeras diversas	III	50
	Sierra para cortar los anillos	XV	11
SIMON	Curetas uterinas	VIII	70, 72
	Separadores	VII	51
SIMPSON	Forceps obstetricos	VIII	57
SIMPSON BRAUN	Forceps obstetricos	VIII	58
SIMPSON LU IKART	Forceps obstetricos	VIII	59
SIMS	Bisturís fijos	I	2
	Curetas uterinas	VIII	73
	Espéculos rectales	VIII	88
	Hysterómetros	VIII	85
	Tijeras de tungsteno	III	68
	Tijeras para intervención en profundidad	III	52
	Tijeras Prestige	III	76
	Valvas vaginales	VIII	45
SIMS-MAIER	Pinzas para vendajes	IV	127
SINGLEY TUTTLE	Pinzas para disección especiales	II	21
SISTERON	Pinzas para calculos biliares	IX	6
SKID MURPHY	Separadores	VII	145
SLUDDER-BALLENGER	O.R.L. amigdalotomo	XII	26
SMILLIE-TRILLAT	Instrumentación para menisco	XIII	151-152
SMITH	Tijeras diversas	III	87
SMITH-PETERSEN	Gubias	XIII	78
	Osea cincelas, osteotomos, gubias	XIII	71-72
	Pinzas gubias	XIII	112
SNELLEN	O.R.L. mazos y curetas	XII	55
SOMMER	Pinzas para coger el útero	VIII	52



		Capítulo	Página
Sondas acanaladas		XV	13
Sondas para varices		V	5
Sondas y Espatulas		V	6
SPENCER	Tijeras para cortar ligaduras	III	41
SPENCER WELLS	Pinzas hemostáticas	IV	15, 18
SPENCER-FINO	Tijeras para cortar ligaduras	III	42
SPINA-NASALIS	Separadores	VII	65
ST MARKS	Valvas vaginales	VIII	47
STAGNARA	Gubias	XIII	80
STAMEY	Agujas para ligaduras	VI	29
STANDARD	Trocates	XV	29
STEINMANN	Cirugía para tendones	XIII	13-14
STELLBRINK	Pinzas gubias	XIII	105
STERNAL	Separadores	VII	101
STERNBERG	O.R.L. abre-boca	XII	8
STEVENS	Tijeras finas	III	43
	Tijeras Prestige	III	73
STEVENS (RIBBON TYPE)	Tijeras finas	III	43
STIEGLITZ	Pinzas para astillas	II	52
STILLE	Instrumentos para vías biliares	IX	9
	Osea cincelas, osteotomos,gubias	XIII	73
	Pinza para escayolas	XV	23
	Pinzas gubias	XIII	111
	Pinzas para disección delicadas	II	15
STILLE-LUER	Pinzas gubias	XIII	115
STOOKEY	Pinzas gubias	XIII	108
STRANDELL-STILLE	Separadores	VII	17
STRASBOURG	Pinzas para disección especiales	II	13
STRATT	Porta agujas	VI	19
STRAUSS	Instrumentos para urología	VIII	86
STRELI	Porta agujas	VI	9
STRUCK	Separadores	VII	104
STRULLY	Tijeras largas y finas	III	48
STRUYCKEN	O.R.L. sacabocados	XII	28
SUBRAMANIAN	Pinzas clamps vasculares atrauma	V	31
SYME	Raspadores y elevadores	XIII	29
	Tablillas maleables	XV	25
TAKAHASHI	O.R.L. sacabocados	XII	28
TAKAHASHI	O.R.L. raspas	XII	42
TARNIER	Forceps obstétricos	VIII	53
TAYLOR	Pinzas para disección delicadas	II	27
	Separadores	XI	7
TEALE	Pinzas uterinas	VIII	10
TEISSIER	Forceps obstétricos	VIII	59
TENOTOME	Bisturís fijos	I	2
	Terrajas	XIV	6
TERRIER	O.R.L. abre-boca	XII	7
	Pinzas hemostáticas	IV	15-16
TESSIER	Separadores	VII	66, 110
THERUM	Diverso	VIII	81
THOMS-ALLIS	Pinzas a presión	IV	97
THUDICHUM (GOLDSMITH)	O.R.L. espéculos	XII	17
TIECK	O.R.L. espéculos	XII	19
	Tijeras de tungsteno	III	57-69
	Tijeras delicadas	III	12-15
	Tijeras episiotomía	III	81-82
	Tijeras finas	III	14, 38-44
	Tijeras largas y finas	III	46-49
	Tijeras ORL	III	83-84
	Tijeras para cirugía ósea	III	86
	Tijeras para cirugía vascular	III	32-36
	Tijeras para cortar hilos	III	31
	Tijeras para cortar ligaduras	III	41-42
	Tijeras para disección	III	16-26
	Tijeras para el cordón umbilical	III	80
	Tijeras para escayolas	XV	22
	Tijeras para incisión	III	28
	Tijeras para intervención en profundidad	III	51-52
	Tijeras para uñas	III	88
	Tijeras para vendajes	III	29-30
	Tijeras Prestige	III	70-79
	Tijeras quirúrgicas	III	9-11
TISCHLER	Pinzas para biopsia	VIII	67
TISCHLER-MORGAN	Pinzas para biopsia	VIII	64
TOENNIS	Raspadores y elevadores	XIII	31
	Tijeras largas y finas	III	47
TOENNIS-ADSON	Tijeras de tungsteno	III	65
	Tijeras largas y finas	III	47
TOENNIS-ADSON-FINO	Tijeras largas y finas	III	47
TOHOKU	Pinzas de campo	IV	106
TOUPET	Separadores	VII	72, 76



		Capítulo	Página
TOUPET (ENTEROSTAT)	Separadores	VII	76
TOWNSEND	Pinzas para biopsia	VIII	67
TRAVERS	Separadores	VII	115
TRELAT	Espéculos rectales	VIII	87
Trephine y perforadores		XIV	37
TREVES	Pinzas para disección especiales	II	12
TRILLAT	Empujador de injertos	XIII	144
	Instrumentación para hombro	XIII	149
	Instrumentación para menisco	XIII	155
	Instrumentación para rodilla	XIII	156
	Separadores	VII	143
Trocares		XV	28-30
TROELTSCH	Pinzas para disección O.R.L.	II	38
TROUSSEAU	O.R.L. dilatadores	XII	12
TROUTMAN	Microcirugía tijeras	X	7
TROUTMAN-BARRAQUER	Microcirugía tijeras	X	5
TUBBS	Dilatadores vasculares	V	40
TUBIANA	Porta agujas	VI	9
TUFFIER	Pinzas a presión	IV	98
	Separadores	VII	38, 49
TULIPE	Phlebectomy	V	7
UCKERMANN	O.R.L. dilatadores	XII	12
UFFENORDE	Curetas	XIII	58
ULRICH	Pinzas para huesos	XIII	131
	Pinzas para vendajes	IV	121
UNIVERSAL	Trocares	XV	29
UNIVERSEL	Tijeras para cortar hilos	III	31
UNNA	Curetas	XIII	53
USA MODEL	Pinza para escayolas	XV	23
VACHER	O.R.L. cierra nudos	XII	20
	O.R.L. espéculos	XII	16
VALLEIX	Hysterómetros	VIII	85
Valvas		VII	57
Valvas vaginales		VIII	37-49
VAN DOREN	Pinzas para biopsia	VIII	63
VANNAS	Microcirugía tijeras	X	4, 9-10
VARADY	Phlebectomy	V	8
VELPEAU (TRICOISE)	Costotomos	XIII	125
Ventosa obstétrica		VIII	61
VERBRUGGE	Pinzas para huesos	XIII	127-130
VERBRUGGE-MULLER	Separadores	VII	136
VERNON	Martillos a reflejos, Estetoscopio	XV	5
VIDAL	Curetas	XIII	52
VINCENT	Pinzas gubias	XIII	99
	Pinzas para disección Prestige	II	49
	Tijeras para cirugía vascular	III	36
VIRCHOW	Instrumentos para amputación	XIII	15, 17
VISE	Pinzas para disección delicadas	II	33
VOLKMANN	Curetas	XIII	54-57
	Curetas uterinas	VIII	71
	Separadores	VII	22-25
WACHENFELDT	Instrumentos de sutura	VI	5
WAGENER	O.R.L. ganchos	XII	45
WAGNER	Raspadores	XIII	51
	Separadores	VII	133
	Tijeras finas	III	14
	Tijeras Prestige	III	72
WALDMANN	Tijeras episiotomía	III	82
WALLICH	Curetas uterinas	VIII	69
WALSHAM	O.R.L. pinzas para reposicionar	XII	35
WALTER -DUVAL	Pinzas a presión	IV	86
WALTER-CARMALT	Pinzas para astillas	II	51
WALTON	Separadores	VII	127
	Tijeras finas	III	40
WANGENSTEEN	Pinzas para disección boca de tungsteno	II	45
	Porta agujas	VI	17
WATSON CHEYNE	Estiletes	XV	12
	Raspadores y elevadores	XIII	31
WAUGH	Pinzas para disección delicadas	II	31
WEBSTER	Porta agujas	VI	8
WECKER	Microcirugía tijeras	X	6
WEIL-BLAKESLEY	Pinzas para laminectomía	XI	15
WEISS	Pinzas para tubos	IV	111
WEITLANER	Separadores	VII	114-115
WEITLANER (MOLLISON)	Separadores	VII	118
WEITLANER-NEURO	Separadores	VII	119
WEITLANER-WULLSTEIN	Separadores	VII	118
WERTHEIM	Pinzas uterinas	VIII	16, 20
	Tijeras para intervención en profundidad	III	52
WERTHEIM (BOZEMANN)	Porta agujas	VI	19
WERTHEIM CULLEN	Pinzas uterinas	VIII	23



		Capítulo	Página
WERTHEIMER	O.R.L. canulas aspirantes	XII	57
WESTCOTT	Microcirugía tijeras	X	3, 7
WHITE	O.R.L. pinzas a prensión	XII	13
WHITEHEAD	O.R.L. abre-boca	XII	9
WICKSTROEM	Disecadores	IV	59
WIEN	O.R.L. espéculos	XII	19
WILLIAMS	Separadores	VII	129
WILLIGER	Curetas	XIII	53
	O.R.L. mazos y curetas	XII	56
	Raspadores y elevadores	XIII	35
WILMER	Tijeras finas	III	39
WINTER	Pinzas uterinas	VIII	29
WOLF	Pinza para escayolas	XV	23
WOODSON	Raspadores y elevadores	XIII	28
WRIGLEY	Forceps obstétricos	VIII	57
WYLIE	Pinzas clamps vasculares atrauma	V	16
YANKAUER	Cánulas aspirantes	XV	26
	Raspadores y elevadores	XIII	34
YASARGIL	Microcirugía porta-agujas	X	13
	Microcirugía tijeras	X	11
	Raspadores y elevadores	XIII	31
YEOMAN	Pinzas para biopsia rectal	VIII	92
YOUNG	Instrumentación de servicio	XV	9
	Instrumentos para prostate	VIII	96
ZENKER	Disecadores	IV	60
	Separadores	VII	48
ZIELKE	Gubias	XIII	83
ZWEIFEL	Porta agujas	VI	26

LANDANGER



Ortho-vertèbre
Ortho-vertebrae
Ortho-vertebra

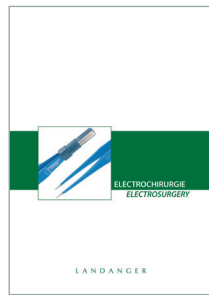

Electrochirurgie
Electrosurgery
Electrocirugía

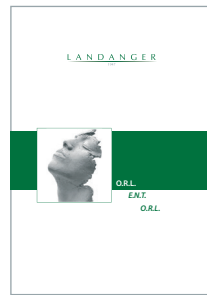

O.R.L.
E.N.T.
O.R.L.

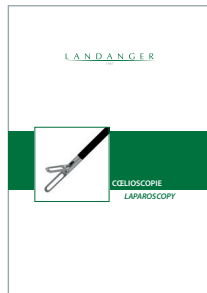

Coelioscopie
Laparoscopy
Laparoscopia



Urologie-Gynécologie
Urology-Gynecology
Urología-Ginecología

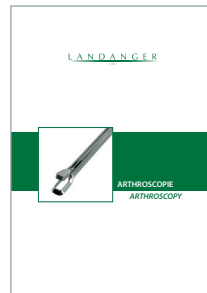

Arthroscopie
Arthroscopy
Artroscopia

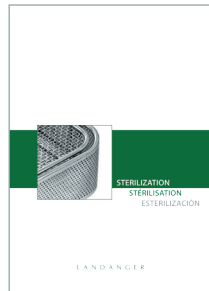

Stérilisation
Sterilization
Esterilización

Indications importantes

Le contenu de ce catalogue de vente (y compris les marques, les textes, les dessins, illustrations, présentations, etc.) est, sauf mention contraire, la propriété exclusive de la société LANDANGER. Toute reproduction, représentation, modification, adaptation, et/ou traduction de ce catalogue - qu'elle soit totale ou partielle, à titre gratuit ou onéreux - est interdite sans l'accord préalable écrit de la société LANDANGER.

Nous pouvons demander le retour du catalogue dans le cas où celui-ci n'est pas utilisé conformément à nos intérêts, pour la vente ou l'achat de nos produits. Dans ce cas nous nous réservons le droit de mener des actions juridiques.

Sous réserve des modifications techniques.

Important notice

The content of this catalogue (including the trademarks, the texts, the drawings, illustrations, layouts, etc.) is, unless otherwise specified, the exclusive property of LANDANGER. It is not allowed to reproduce, represent, display, modify, adapt an/or translate - whether in part or in whole and whether for free or for financial consideration - the catalogue and/or any material composing the catalogue, without the prior and written consent of LANDANGER.

We can at any time recall the catalogue, in case that it has been not used according to our interests, i.e. sale or purchase of our products. We preserve the right for further steps in that case.

Patterns are subject to change.

Indicaciones importantes

El contenido de este catálogo (marcas, textos, dibujos, ilustraciones, presentaciones incluidos, etc.) es, excepto mención contraria, exclusiva propiedad de la empresa LANDANGER. Toda reproducción, representación, modificación, adaptación, y/o traducción de este catálogo - que sea total o parcial, gratuitamente o pagando - esta prohibida sin el acuerdo escrito de la empresa LANDANGER.

Podemos pedir el retorno del catálogo en caso de que este no sea usado conforme a nuestro interés, para la venta o la compra de nuestros productos. En aquel caso, nos reservamos el derecho de dirigir acciones jurídicas.

Bajo reserva de modificaciones técnicas.

Version 2022-07 - Catalogue de vente - ZA-A10002

Conception et design - Concept and design - Concepto y diseño : Copyright©LANDANGER - 1947 - 2022.

Tous droits réservés - All rights reserved - Todos derechos reservados.

Photos et illustrations non contractuelles - The photos and pictures are not contractual - Fotos e ilustraciones no contractuales.



L A N D A N G E R

1947

Service clients - Customer service - Servizio al cliente

Rue Renée et Louis Landanger - 52000 Chaumont - FRANCE
Tél.: +33 (0)3 25 02 10 10 - Fax : +33(0)3 25 02 10 20 - Email : contact@landanger.com

Siège - Corporate office - Sede

217-219 Rue du Faubourg St-Honoré - 75008 Paris - FRANCE